





HTR-5560

AV Receiver

OWNER'S MANUAL

SAFETY INSTRUCTIONS

	CAUTION RISK OF ELECTRIC SHOCK DO NOT OPEN	
<p>CAUTION: TO REDUCE THE RISK OF ELECTRIC SHOCK, DO NOT REMOVE PARTS (OR BACK). NO USER-SERVICEABLE PARTS INSIDE. REFER SERVICING TO QUALIFIED SERVICE PERSONNEL.</p>		

• Explanation of Graphical Symbols



The lightning flash with arrowhead symbol, within an equilateral triangle, is intended to alert you to the presence of uninsulated "dangerous voltage" within the product's enclosure that may be of sufficient magnitude to constitute a risk of electric shock to persons.



The exclamation point within an equilateral triangle is intended to alert you to the presence of important operating and maintenance (servicing) instructions in the literature accompanying the appliance.

<p>WARNING TO REDUCE THE RISK OF FIRE OR ELECTRIC SHOCK, DO NOT EXPOSE THIS UNIT TO RAIN OR MOISTURE.</p>

- 1 Read Instructions – All the safety and operating instructions should be read before the product is operated.
- 2 Retain Instructions – The safety and operating instructions should be retained for future reference.
- 3 Heed Warnings – All warnings on the product and in the operating instructions should be adhered to.
- 4 Follow Instructions – All operating and use instructions should be followed.
- 5 Cleaning – Unplug this product from the wall outlet before cleaning. Do not use liquid cleaners or aerosol cleaners. Use a damp cloth for cleaning.
- 6 Attachments – Do not use attachments not recommended by the product manufacturer as they may cause hazards.
- 7 Water and Moisture – Do not use this product near water – for example, near a bath tub, wash bowl, kitchen sink, or laundry tub; in a wet basement; or near a swimming pool; and the like.
- 8 Accessories – Do not place this product on an unstable cart, stand, tripod, bracket, or table. The product may fall, causing serious injury to a child or adult, and serious damage to the product. Use only with a cart, stand, tripod, bracket, or table recommended by the manufacturer, or sold with the product. Any mounting of the product should follow the manufacturer's instructions, and should use a mounting accessory recommended by the manufacturer.
- 9 A product and cart combination should be moved with care. Quick stops, excessive force, and uneven surfaces may cause the product and cart combination to overturn.



- 10 Ventilation – Slots and openings in the cabinet are provided for ventilation and to ensure reliable operation of the product and to protect it from overheating, and these openings must not be blocked or covered. The openings should never be blocked by placing the product on a bed, sofa, rug, or other similar surface. This product should not be placed in a built-in installation such as a bookcase or rack unless proper ventilation is provided or the manufacturer's instructions have been adhered to.
- 11 Power Sources – This product should be operated only from the type of power source indicated on the marking label. If you are not sure of the type of power supply to your home, consult your product dealer or local power company. For products intended to operate from battery power, or other sources, refer to the operating instructions.
- 12 Grounding or Polarization – This product may be equipped with a polarized alternating current line plug (a plug having one blade wider than the other). This plug will fit into the power outlet only one way. This is a safety feature. If you are unable to insert the plug fully into the outlet, try reversing the plug. If the plug should still fail to fit, contact your electrician to replace your obsolete outlet. Do not defeat the safety purpose of the polarized plug.
- 13 Power-Cord Protection – Power-supply cords should be routed so that they are not likely to be walked on or pinched by items placed upon or against them, paying particular attention to cords at plugs, convenience receptacles, and the point where they exit from the product.
- 14 Lightning – For added protection for this product during a lightning storm, or when it is left unattended and unused for long periods of time, unplug it from the wall outlet and disconnect the antenna or cable system. This will prevent damage to the product due to lightning and power-line surges.
- 15 Power Lines – An outside antenna system should not be located in the vicinity of overhead power lines or other electric light or power circuits, or where it can fall into such power lines or circuits. When installing an outside antenna system, extreme care should be taken to keep from touching such power lines or circuits as contact with them might be fatal.
- 16 Overloading – Do not overload wall outlets, extension cords, or integral convenience receptacles as this can result in a risk of fire or electric shock.
- 17 Object and Liquid Entry – Never push objects of any kind into this product through openings as they may touch dangerous voltage points or short-out parts that could result in a fire or electric shock. Never spill liquid of any kind on the product.
- 18 Servicing – Do not attempt to service this product yourself as opening or removing covers may expose you to dangerous voltage or other hazards. Refer all servicing to qualified service personnel.
- 19 Damage Requiring Service – Unplug this product from the wall outlet and refer servicing to qualified service personnel under the following conditions:
 - a) When the power-supply cord or plug is damaged,
 - b) If liquid has been spilled, or objects have fallen into the product,
 - c) If the product has been exposed to rain or water,

- d) If the product does not operate normally by following the operating instructions. Adjust only those controls that are covered by the operating instructions as an improper adjustment of other controls may result in damage and will often require extensive work by a qualified technician to restore the product to its normal operation,
- e) If the product has been dropped or damaged in any way, and
- f) When the product exhibits a distinct change in performance - this indicates a need for service.
- 20 Replacement Parts – When replacement parts are required, be sure the service technician has used replacement parts specified by the manufacturer or have the same characteristics as the original part. Unauthorized substitutions may result in fire, electric shock, or other hazards.
- 21 Safety Check – Upon completion of any service or repairs to this product, ask the service technician to perform safety checks to determine that the product is in proper operating condition.
- 22 Wall or Ceiling Mounting – The unit should be mounted to a wall or ceiling only as recommended by the manufacturer.
- 23 Heat – The product should be situated away from heat sources such as radiators, heat registers, stoves, or other products (including amplifiers) that produce heat.
- 24 Outdoor Antenna Grounding – If an outside antenna or cable system is connected to the product, be sure the antenna or cable system is grounded so as to provide some protection against voltage surges and built-up static charges. Article 810 of the National Electrical Code, ANSI/NFPA 70, provides information with regard to proper grounding of the mast and supporting structure, grounding of the lead-in wire to an antenna discharge unit, size of grounding conductors, location of antenna discharge unit, connection to grounding electrodes, and requirements for the grounding electrode.

EXAMPLE OF ANTENNA GROUNDING

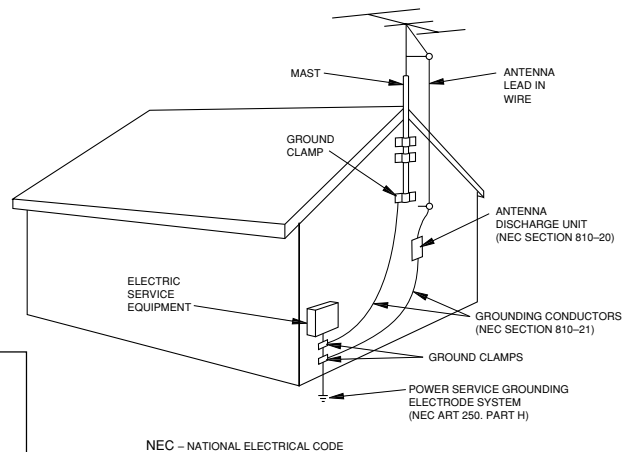
**Note to CATV system installer:**

This reminder is provided to call the CATV system installer's attention to Article 820-40 of the NEC that provides guidelines for proper grounding and, in particular, specifies that the cable ground shall be connected to the grounding system of the building, as close to the point of cable entry as practical.

FCC INFORMATION (for US customers only)

- IMPORTANT NOTICE : DO NOT MODIFY THIS UNIT!**
This product, when installed as indicated in the instructions contained in this manual, meets FCC requirements. Modifications not expressly approved by Yamaha may void your authority, granted by the FCC, to use the product.
- IMPORTANT :** When connecting this product to accessories and/or another product use only high quality shielded cables. Cable/s supplied with this product **MUST** be used. Follow all installation instructions. Failure to follow instructions could void your FCC authorization to use this product in the USA.
- NOTE :** This product has been tested and found to comply with the requirements listed in FCC Regulations, Part 15 for Class "B" digital devices. Compliance with these requirements provides a reasonable level of assurance that your use of this product in a residential environment will not result in harmful interference with other electronic devices.
This equipment generates/uses radio frequencies and, if not installed and used according to the instructions found in the users manual, may cause interference harmful to the operation of other electronic devices.

Compliance with FCC regulations does not guarantee that interference will not occur in all installations. If this product is found to be the source of interference, which can be determined by turning the unit "OFF" and "ON", please try to eliminate the problem by using one of the following measures:

Relocate either this product or the device that is being affected by the interference.

Utilize power outlets that are on different branch (circuit breaker or fuse) circuits or install AC line filter/s.

In the case of radio or TV interference, relocate/reorient the antenna. If the antenna lead-in is 300 ohm ribbon lead, change the lead-in to coaxial type cable.

If these corrective measures do not produce satisfactory results, please contact the local retailer authorized to distribute this type of product. If you can not locate the appropriate retailer, please contact Yamaha Electronics Corp., U.S.A. 6660 Orangethorpe Ave, Buena Park, CA 90620.

The above statements apply **ONLY** to those products distributed by Yamaha Corporation of America or its subsidiaries.

CAUTION: READ THIS BEFORE OPERATING YOUR UNIT.

- 1 To assure the finest performance, please read this manual carefully. Keep it in a safe place for future reference.
- 2 Install this unit in a well ventilated, cool, dry, clean place with at least 30 cm on the top, 20 cm on the left and right, and 10 cm at the back of this unit — away from direct sunlight, heat sources, vibration, dust, moisture, and/or cold.
- 3 Locate this unit away from other electrical appliances, motors, or transformers to avoid humming sounds. To prevent fire or electrical shock, do not place this unit where it may get exposed to rain, water, and/or any type of liquid.
- 4 Do not expose this unit to sudden temperature changes from cold to hot, and do not locate this unit in a environment with high humidity (i.e. a room with a humidifier) to prevent condensation inside this unit, which may cause an electrical shock, fire, damage to this unit, and/or personal injury.
- 5 On the top of this unit, do not place:
 - Other components, as they may cause damage and/or discoloration on the surface of this unit.
 - Burning objects (i.e. candles), as they may cause fire, damage to this unit, and/or personal injury.
 - Containers with liquid in them, as they may cause electrical shock to the user and/or damage to this unit.
- 6 Do not cover this unit with a newspaper, tablecloth, curtain, etc. in order not to obstruct heat radiation. If the temperature inside this unit rises, it may cause fire, damage to this unit, and/or personal injury.
- 7 Do not plug in this unit to a wall outlet until all connections are complete.
- 8 Do not operate this unit upside-down. It may overheat, possibly causing damage.
- 9 Do not use force on switches, knobs and/or cords.
- 10 When disconnecting the power cord from the wall outlet, grasp the plug; do not pull the cord.
- 11 Do not clean this unit with chemical solvents; this might damage the finish. Use a clean, dry cloth.
- 12 Only voltage specified on this unit must be used. Using this unit with a higher voltage than specified is dangerous and may cause fire, damage to this unit, and/or personal injury. YAMAHA will not be held responsible for any damage resulting from use of this unit with a voltage other than specified.
- 13 To prevent damage by lightning, disconnect the power cord from the wall outlet during an electrical storm.
- 14 Take care of this unit so that no foreign objects and/or liquid drops inside this unit.
- 15 Do not attempt to modify or fix this unit. Contact qualified YAMAHA service personnel when any service is needed. The cabinet should never be opened for any reasons.
- 16 When not planning to use this unit for long periods of time (i.e. vacation), disconnect the AC power plug from the wall outlet.
- 17 Be sure to read the “TROUBLESHOOTING” section on common operating errors before concluding that this unit is faulty.
- 18 Before moving this unit, press STANDBY/ON to set this unit in the standby mode, and disconnect the AC power plug from the wall outlet.
- 19 **VOLTAGE SELECTOR (China and General models only)**
The VOLTAGE SELECTOR on the rear panel of this unit must be set for your local main voltage BEFORE plugging into the AC main supply. Voltages are 110/120/220/240 V AC, 50/60 Hz.

This unit is not disconnected from the AC power source as long as it is connected to the wall outlet, even if this unit itself is turned off. This state is called the standby mode. In this state, this unit is designed to consume a very small quantity of power.

IMPORTANT

Please record the serial number of this unit in the space below.

MODEL:

Serial No.:

The serial number is located on the rear of the unit.

Retain this Owner's Manual in a safe place for future reference.

FOR CANADIAN CUSTOMERS

To prevent electric shock, match wide blade of plug to wide slot and fully insert.

This Class B digital apparatus complies with Canadian ICES-003.

We Want You Listening For A Lifetime

YAMAHA and the Electronic Industries Association's Consumer Electronics Group want you to get the most out of your equipment by playing it at a safe level. One that lets the sound come through loud and clear without annoying blaring or distortion – and, most importantly, without affecting your sensitive hearing.

Since hearing damage from loud sounds is often undetectable until it is too late, YAMAHA and the Electronic Industries Association's Consumer Electronics Group recommend you to avoid prolonged exposure from excessive volume levels.



CONTENTS

INTRODUCTION

CONTENTS	1
FEATURES	2
GETTING STARTED	3
Checking the package contents	3
Installing batteries in the remote control	3
CONTROLS AND FUNCTIONS	4
Front panel	4
Remote control	6
Using the remote control	7
Front panel display	8

PREPARATION

SPEAKER SETUP	9
Speakers	9
Speaker placement	9
Connecting the speakers	10
CONNECTIONS	13
Before connecting components	13
Connecting video components	14
Connecting audio components	16
Connecting the antennas	17
Connecting an external amplifier	18
Connecting an external decoder	18
Connecting the power supply cords	19
Turning on the power	19
SPEAKER MODE SETTINGS	20
ADJUSTING SPEAKER OUTPUT LEVELS ..	21
Before you begin	21
Using the test tone	21

BASIC OPERATION

BASIC PLAYBACK	23
Input modes and indications	25
Selecting a sound field program	26
DIGITAL SOUND FIELD PROCESSING	
(DSP)	29
Understanding sound fields	29
Hi-Fi DSP programs	29
CINEMA-DSP	30
Sound design of CINEMA-DSP	30
CINEMA-DSP programs	32
TUNING	34
Automatic and manual tuning	34
Presetting stations	35
Tuning in to a preset station	37
Exchanging preset stations	37
SLEEP TIMER	38
Setting the sleep timer	38
Canceling the sleep timer	38
RECORDING	39

ADVANCED OPERATION

SET MENU	40
Adjusting the items on the SET MENU	40
1 SPEAKER SET (speaker mode settings)	41
2 LFE LEVEL	43
3 SP DLY TIME (speaker delay time)	43
4 D. RANGE (dynamic range)	44
5 L/R BALANCE (balance of the main left and right speakers)	44
6 HP TONE CTRL (headphone tone control)	44
7 I/O ASSIGN (input/output assignment)	44
8 INPUT MODE (initial input mode)	45
9 DISPLAY SET	45
10MEM. GUARD (memory guard)	45
REMOTE CONTROL FEATURES	46
Control area	46
Setting the manufacturer code	47
Clearing setup manufacturer codes	47
Controlling other components	48
ADJUSTING THE LEVEL OF THE EFFECT	
SPEAKERS	49
ADJUSTING THE DELAY TIME	50
ADJUSTING THE PARAMETER SETTINGS	
FOR PRO LOGIC II MUSIC	51
Changing parameter settings	51
PRO LOGIC II Music parameter descriptions	51

ADDITIONAL INFORMATION

TROUBLESHOOTING	52
GLOSSARY	56
SPECIFICATIONS	58

FEATURES

Built-in 6-channel power amplifier

- ◆ Minimum RMS output power (0.06% THD, 20 Hz – 20 kHz, 8Ω)
 - Main: 75 W + 75 W
 - Center: 75 W
 - Rear: 75 W + 75 W
 - Rear center: 75 W

Multi-mode digital sound field processing

- ◆ Dolby Pro Logic/Dolby Pro Logic II decoder
- ◆ Dolby Digital/Dolby Digital EX decoder
- ◆ DTS/DTS-ES compatible decoder
- ◆ CINEMA DSP: Combination of YAMAHA DSP technology and Dolby Pro Logic, Dolby Digital or DTS
- ◆ Virtual CINEMA DSP
- ◆ SILENT CINEMA DSP

Sophisticated AM/FM Tuner

- ◆ 40-Station random access preset tuning
- ◆ Automatic preset tuning
- ◆ Preset station shifting capability (Preset editing)

Other features

- ◆ 96-kHz/24-bit D/A converter
- ◆ “SET MENU” for optimizing this unit for your Audio/Video system
- ◆ Test tone generator for easier speaker balance adjustment
- ◆ 6-channel external decoder input
- ◆ S-video signal input/output capability
- ◆ Component video input/output capability
- ◆ Optical and coaxial digital audio signal jacks
- ◆ Sleep timer
- ◆ Remote control with preset manufacturer codes

■ About this manual

- ☀ indicates a tip for your operation.
- Some operations can be performed by using either the buttons on the main unit or on the remote control. In cases when the button names differ between the main unit and the remote control, the button name on the remote control is given in parentheses.
- This manual is printed prior to production. Design and specifications are subject to change in part for the reason of the improvement in operativity ability, and others. In this case, the product has priority.



Manufactured under license from Dolby Laboratories.

“Dolby”, “Pro Logic”, and the double-D symbol are trademarks of Dolby Laboratories.



“DTS”, “ES” and “DTS Digital Surround” are trademarks of Digital Theater Systems, Inc.

GETTING STARTED

Checking the package contents

Check your package to make sure it contains the following items.

Remote control

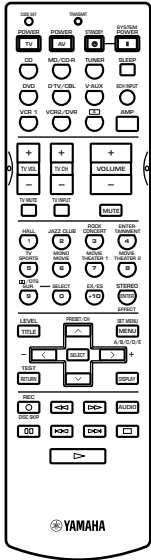

Batteries (4)
(AAA, R03, UM-4)

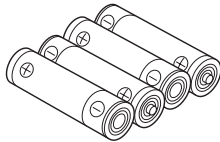

AM loop antenna



Indoor FM antenna
(U.S.A., Canada, China,
Korea and General models)

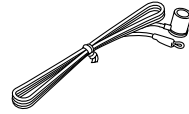

Front VIDEO AUX jack cap

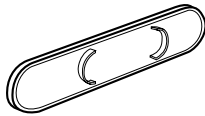

75-ohm/300-ohm antenna
adapter (U.K. model)

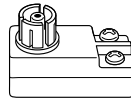

(Europe, U.K., Australia and
Singapore models)

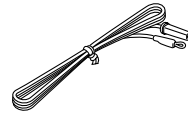

Installing batteries in the remote control

Insert the batteries in the correct direction by aligning the + and – marks on the batteries with the polarity markings (+ and –) inside the battery compartment.

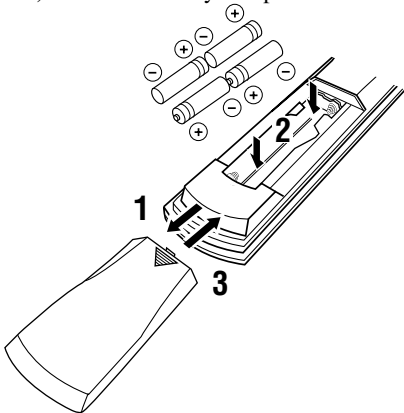

- 1** Press the ▼ part and slide off the battery compartment cover.
- 2** Insert the four supplied batteries (AAA, R03, UM-4) according to the polarity markings on the inside of the battery compartment.
- 3** Slide the cover back on so that it snaps into place.

Notes on batteries

- Change all of the batteries if you notice a decrease in the operating range of the remote control, that the indicator does not flash, or the light becoming dim.
- Do not use old batteries together with new ones.
- Do not use different types of batteries (such as alkaline and manganese batteries) together. Read the packaging carefully as these different types of batteries may have the same shape and color.
- If the batteries have leaked, dispose of them immediately. Avoid touching the leaked material or letting it come into contact with clothing, etc. Clean the battery compartment thoroughly before installing new batteries.

If the remote control is without batteries for more than 2 minutes, or if exhausted batteries remain in the remote control, the contents of the memory may be cleared. When the memory is cleared, insert new batteries, set up the manufacturer code that may have been cleared.

CONTROLS AND FUNCTIONS

Front panel

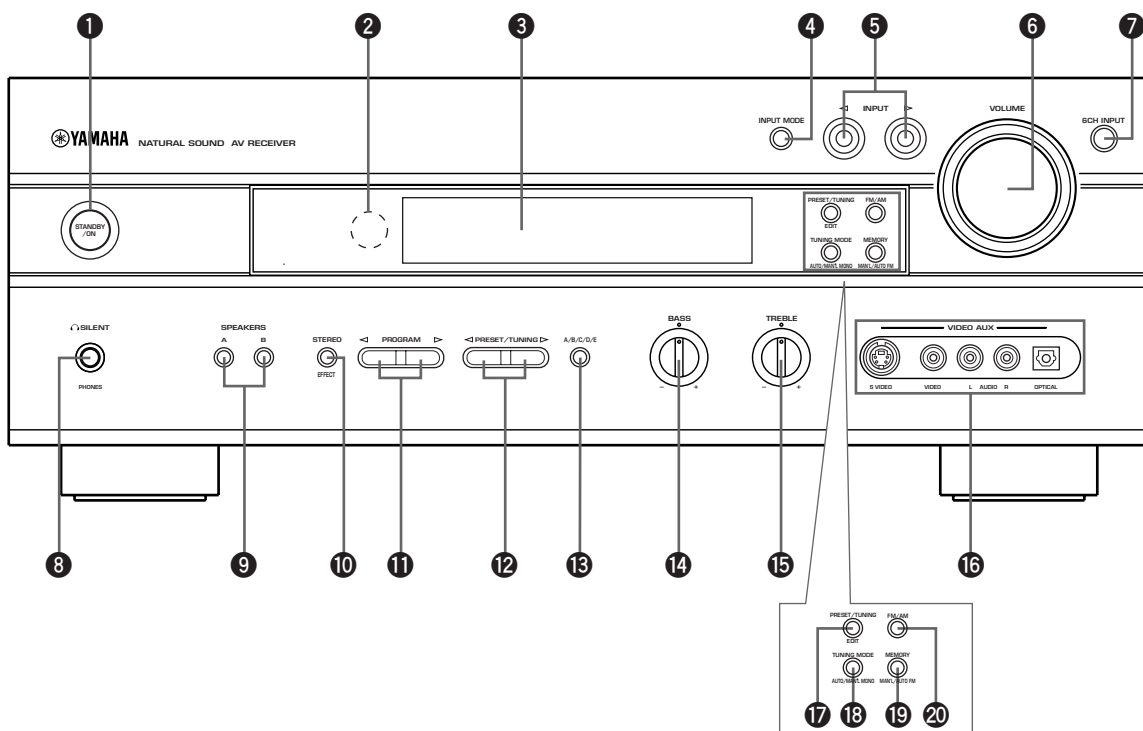

1 STANDBY/ON

Turns this unit on, or set it to the standby mode. When you turn this unit on, you will hear a click and there will be a 4 to 5-second delay before this unit can reproduce sound.

Standby mode

In this mode, this unit will consume a small amount of power in order to receive infrared-signals from the remote control.

2 Remote control sensor

Receives signals from the remote control.

3 Front panel display

Shows information about the operational status of this unit.

4 INPUT MODE

Sets the priority for the types of input signals (AUTO, DTS, ANALOG) to receive when one component is connected to two or more input jacks. Priority cannot be set when 6CH INPUT is selected as the input source.

5 INPUT $\triangleleft/\triangleright$

Selects the input source you want to listen to or watch.

6 VOLUME

Controls the output level of all audio channels. This does not affect the OUT (REC) level.

7 6CH INPUT

Selects the audio source connected to the 6CH INPUT jacks. This audio takes priority over the source selected with INPUT $\triangleleft/\triangleright$ (or the input selector buttons on the remote control).

8 SILENT (PHONES jack)

Allows you enjoy DSP effect for private listening with headphones. When you connect headphones, no signals are output to the speakers or the OUTPUT jacks.

9 SPEAKERS A/B

Turns the set of main speakers connected to the A and/or B terminals on or off.

10 STEREO/EFFECT

Switches between normal stereo and DSP effect reproduction. When STEREO is selected, 2-channel signals are directed to the main left and right speakers without effect sounds and all Dolby Digital and DTS signals (except the LFE channel) are mixed down to the main left and right speakers.

11 PROGRAM </>

Selects the DSP program.

12 PRESET/TUNING </>

Selects preset station numbers 1 to 8 when the colon (:) appears in the front panel display. Selects the tuning frequency when the colon (:) does not appear.

13 A/B/C/D/E

Selects preset station groups A to E.

14 BASS

Adjusts the low-frequency response for the main left and right channels. Turn right to increase or turn left to decrease the low-frequency response.

15 TREBLE

Adjusts the high-frequency response for the main left and right channels. Turn right to increase or turn left to decrease the high-frequency response.

16 VIDEO AUX jacks

Inputs for audio and video signals from a portable external source (game console, etc.). Set the input source to V-AUX to enjoy source signals from these jacks. When the VIDEO AUX jacks on the front panel are not used, you can attach the provided front VIDEO AUX jack cap as shown in the illustration. When the cap is not attached, be sure retain it carefully.

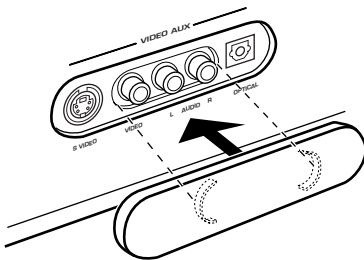
**17 PRESET/TUNING (EDIT)**

Switches the function of PRESET/TUNING </> between selecting a preset station number and tuning (the colon (:) turns on or off). This button is also used to exchange the assignment of two preset stations with each other.

18 TUNING MODE (AUTO/MAN'L MONO)

Switches the tuning mode between automatic and manual.

19 MEMORY (MAN'L/AUTO FM)

Stores the current station in the memory.

20 FM/AM

Switches the reception band between FM and AM.

Remote control

This section describes the remote control controls and their functions. Make sure that the AMP mode is selected before starting operation. See “REMOTE CONTROL FEATURES” on pages 46 to 48.

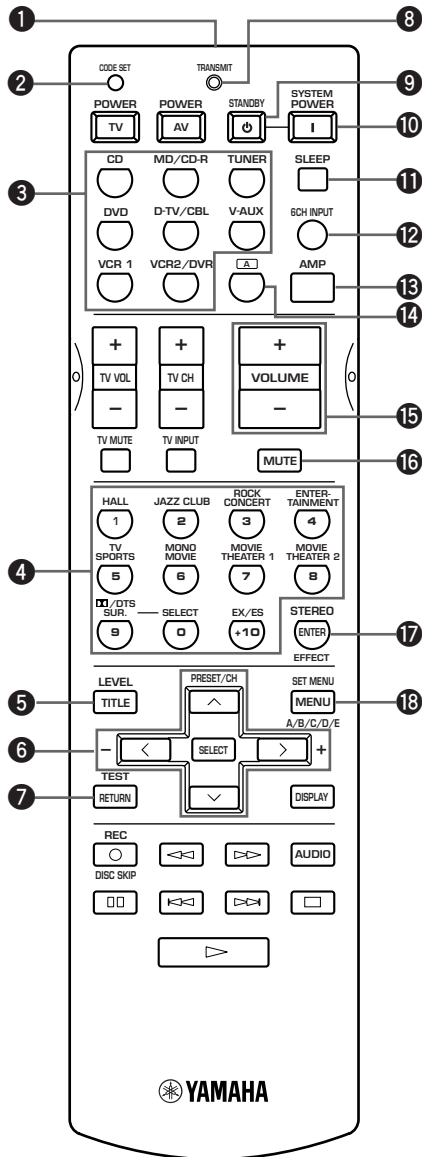

1 Infrared window

Outputs infrared control signals. Aim this window at the component you want to operate.

2 CODE SET

Used when setting up the manufacturer code (see page 47).

3 Input selector buttons

Select the input source and set the remote control to operate the selected source component.

4 DSP program

Select DSP programs for the AMP position. Press a button repeatedly to select a DSP program within that group.

5 LEVEL

Selects the effect speaker channel to be adjusted.

6 Multi control section

Used when changing the setting and to implement the settings.

7 TEST

Outputs the test tone to adjust the speaker levels.

8 TRANSMIT indicator

Flashes while the remote control is sending signals.

9 STANDBY

Sets this unit in the standby mode.

10 SYSTEM POWER

Turns on the power of this unit.

11 SLEEP

Sets the sleep timer.

12 6CH INPUT

Selects the audio source connected to the 6CH INPUT jacks.

13 AMP

Sets the remote control to the AMP mode for controlling this unit.

14 A

Sets the remote control to operate other component (not necessarily connected to this unit) without changing this unit's input source.

15 VOLUME +/-

Increases or decreases the volume level.

16 MUTE

Mutes the sound. Press again to restore the audio output to the previous volume level.

17 STEREO/EFFECT

Switches between normal stereo and DSP effect reproduction. When STEREO is selected, 2-channel signals are directed to the main left and right speakers without effect sounds and all Dolby Digital and DTS signals (except the LFE channel) are mixed down to the main left and right speakers.

18 SET MENU

Selects the SET MENU mode.

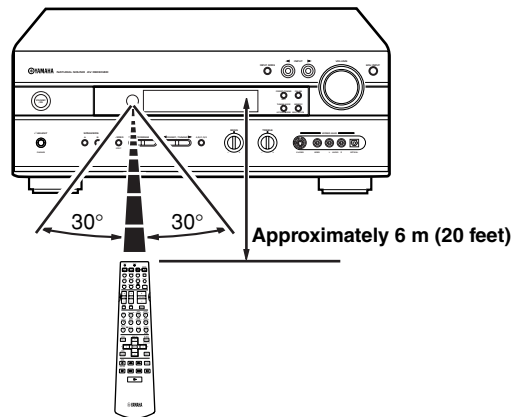
Using the remote control

The remote control transmits a directional infrared beam. Be sure to aim the remote control directly at the remote control sensor on the main unit during operation.

Handling the remote control

- Do not spill water or other liquids on the remote control.
- Do not drop the remote control.
- Do not leave or store the remote control in the following types of conditions:
 - high humidity or temperature such as near a heater, stove or bath;
 - dusty places; or
 - in places subject to extremely low temperatures.

Front panel display

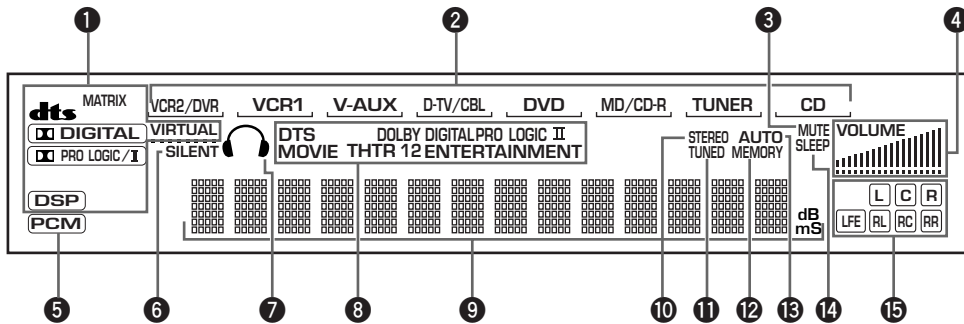

1 Processor indicators

Lights up when the **dts**, **DIGITAL**, **VIRTUAL**, **PRO LOGIC II** or **DSP** are activated.

MATRIX lights up when the Dolby Digital EX decoder or the DTS-ES compatible decoder is activated.

2 Input source indicator

Shows the current input source with a cursor.

3 MUTE indicator

Flashes while the MUTE function is on.

4 VOLUME level indicator

Indicates the volume level.

5 PCM indicator

Lights up when this unit is reproducing PCM (pulse code modulation) digital audio signals.

6 SILENT indicator

Lights up when headphones are connected while the digital sound field processor is on.

7 Headphones indicator

Lights up when headphones are connected.

8 DSP program indicators

The name of the selected DSP program lights up when the ENTERTAINMENT, MOVIE THEATER 1, MOVIE THEATER 2 or **DTS**/DTS SURROUND DSP program is selected.

9 Multi-information display

Shows the current DSP program name and other information when adjusting or changing settings.

10 STEREO indicator

Lights up when this unit is receiving a strong signal for an FM stereo broadcast while the "AUTO" indicator is lit.

11 TUNED indicator

Lights up when this unit is tuned to a station.

12 MEMORY indicator

Flashes to show a station can be stored.

13 AUTO indicator

Shows that this unit is in the automatic tuning mode.

14 SLEEP indicator

Lights up while the sleep timer is on.

15 Input channel indicator

Indicates the channel components of input signals being received.

SPEAKER SETUP

Speakers

This unit has been designed to provide the best sound-field quality with a 6-speaker system, using main left and right speakers, rear left and right speakers, a center speaker, and a rear center speaker. If you use different brands of speakers (with different tonal qualities) in your system, the tone of a moving human voice and other types of sound may not shift smoothly. We recommend that you use speakers from the same manufacturer or speakers with the same tonal quality.

The main speakers are used for the main source sound plus effect sounds. They will probably be the speakers from your present stereo system. The rear speakers are used for effect and surround sounds. The center speaker is for the center sounds (dialog, vocals, etc.). The rear center speaker supplements the rear (left and right) speakers and provides for more realistic front-to-back transitions.

The main speakers should be high-performance models and have enough power-handling capacity to accept the maximum output of your audio system. The other speakers do not have to be equal to the main speakers. For precise sound localization, however, it is ideal to use the models of equivalent performance with the main speakers.

■ Use of a subwoofer expands your sound field

It is also possible to further expand your system with the addition of a subwoofer. The use of a subwoofer is effective not only for reinforcing bass frequencies from any or all channels, but also for reproducing the LFE (low-frequency effect) channel with high fidelity when playing back Dolby Digital or DTS signals. The YAMAHA Active Servo Processing Subwoofer System is ideal for natural and lively bass reproduction.

Speaker placement

Refer to the following diagram when you place the speakers.

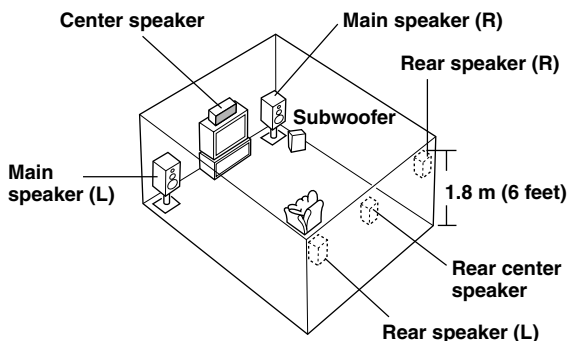

■ Main speakers

Place the main left and right speakers an equal distance from the ideal listening position. The distance between each speaker and each side of the video monitor should also be the same.

■ Center speaker

Align the front face of the center speaker with the front face of your video monitor. Place the speaker as close to the monitor as possible (such as directly over or under the monitor) and centrally between the main speakers.

■ Rear speakers

Place these speakers behind your listening position, facing slightly inwards, nearly 1.8 m (6 feet) above the floor.

■ Rear center speaker

Place the rear center speaker in the center between the rear left and right speakers at the same height from the floor as the rear speakers.

■ Subwoofer

The position of the subwoofer is not so critical, because low bass sounds are not highly directional. But it is better to place the subwoofer near the main speakers. Turn it slightly toward the center of the room to reduce wall reflections.

Note

- If you do not use any of effect speakers (rear, center and/or rear center), change the settings of SPEAKER SET items at the SET MENU to designate the signals to other terminals you connect speakers to.

CAUTION

Use magnetically shielded speakers. If this type of speakers still creates the interference with the monitor, place the speakers away from the monitor.

Connecting the speakers

Be sure to connect the left channel (L), right channel (R), “+” (red) and “-” (black) properly. If the connections are faulty, no sound will be heard from the speakers, and if the polarity of the speaker connections is incorrect, the sound will be unnatural and lack bass.

CAUTION

- Use speakers with the specified impedance shown on the rear panel of this unit.
- Do not let the bare speaker wires touch each other or any metal part of this unit. This could damage this unit and/or the speakers.

If necessary, use the SET MENU to change the speaker mode settings according to the number and size of the speakers in your configuration after you finish connecting your speakers.

■ Speaker cables

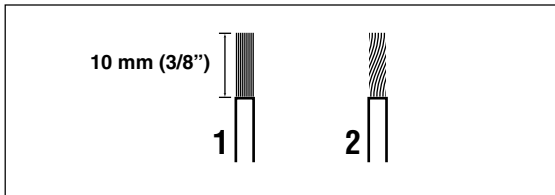

A speaker cord is actually a pair of insulated cables running side by side. One cable is colored or shaped differently, perhaps with a stripe, groove or ridge.

- 1 Remove approximately 10 mm (3/8") of insulation from each of the speaker cables.**
- 2 Twist the exposed wires of the cable together to prevent short circuits.**

■ Connecting to the SPEAKERS terminals

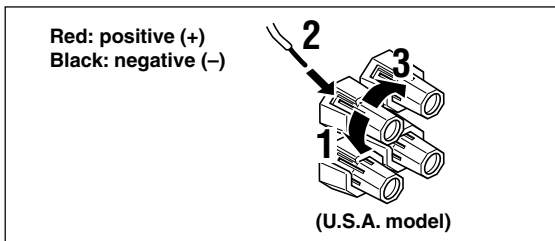

- 1 Unscrew the knob.**
- 2 Insert one bare wire into the hole in the side of each terminal.**
- 3 Tighten the knob to secure the wire.**

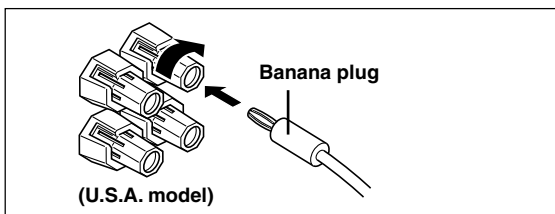

- (U.S.A., Canada, Australia, China, Korea and General models)
- Banana plug connections are also possible. First, tighten the knob and then insert the banana plug connector into the end of the corresponding terminal.

■ MAIN SPEAKERS terminals

One or two speaker systems can be connected to these terminals. When using only one speaker system, it can be connected to either the MAIN A or the MAIN B terminals.

■ REAR SPEAKERS terminals

A rear speaker system can be connected to these terminals.

■ CENTER SPEAKER terminals

A center speaker can be connected to these terminals.

■ REAR CENTER SPEAKER terminals

A rear center speaker can be connected to these terminals.

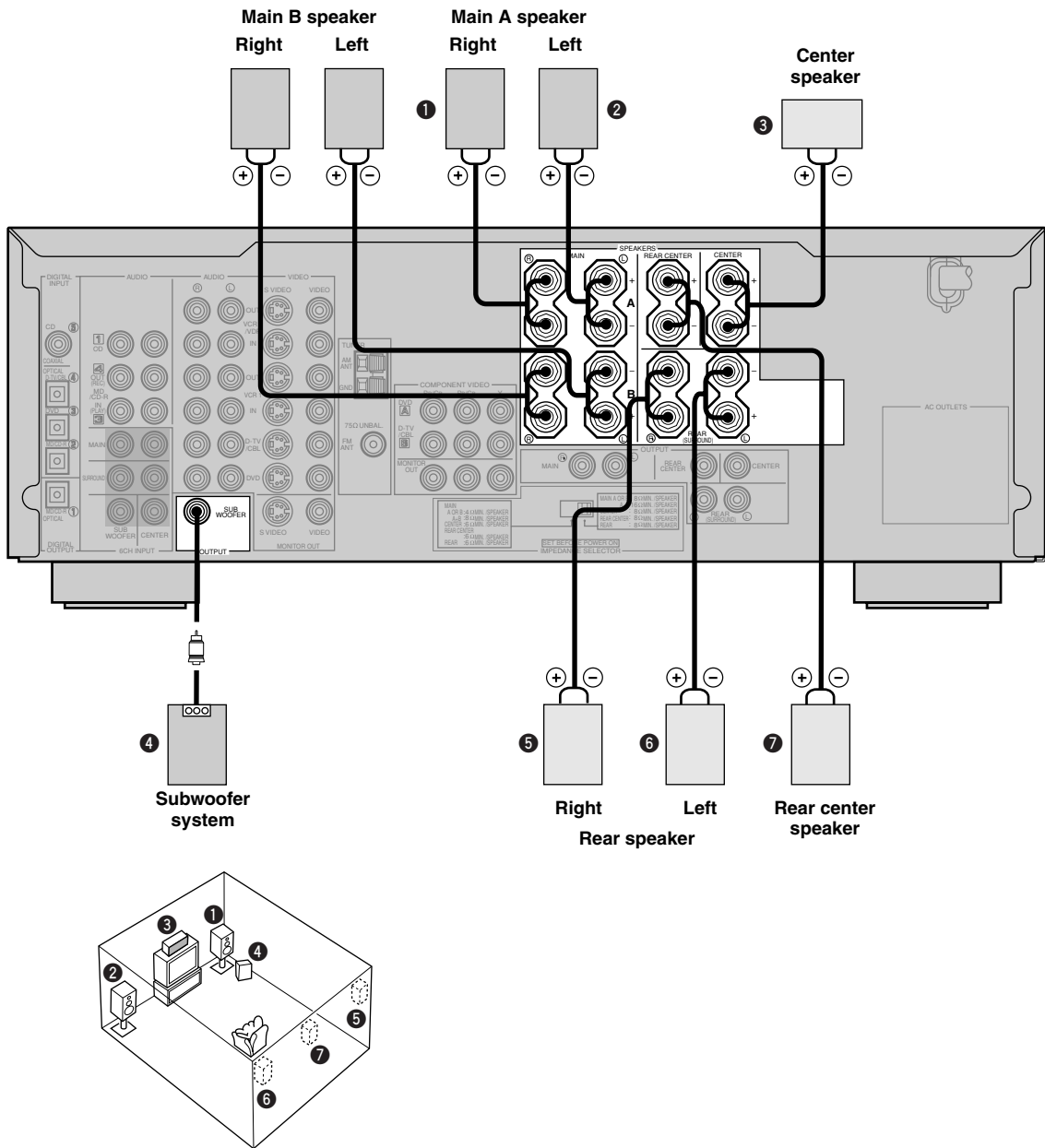

The diagram shows the speaker layout in the listening room.

■ SUBWOOFER jack

When using a subwoofer with built-in amplifier, including the YAMAHA Active Servo Processing Subwoofer System, connect the input jack of the subwoofer system to this jack. Low bass signals distributed from the main, center and/or rear channels are directed to this jack in accordance with your SPEAKER SET selections. The LFE (low-frequency effect) signals generated when Dolby Digital or DTS is decoded are also directed to this jack in accordance with your SPEAKER SET selections.

Notes

- The cut-off frequency of the SUBWOOFER jack is 90 Hz.
- If you do not use a subwoofer, designate the signals to the main left and right speakers by changing the setting of SPEAKER SET item "1E BASS" on the SET MENU to MAIN.
- Use the control on the subwoofer to adjust its volume level. It is also possible to adjust the volume level by using this unit's remote control (see "ADJUSTING THE LEVEL OF THE EFFECT SPEAKERS" on page 49).

■ IMPEDANCE SELECTOR switch

WARNING

Do not change setting of the IMPEDANCE SELECTOR switch when the power of this unit is on, this may damage the unit. If this unit fails to turn on when STANDBY/ON (or SYSTEM POWER) is pressed, the IMPEDANCE SELECTOR switch may not be fully slid to either position. If so, slide the switch all the way to either position when this unit is in the standby mode.

Select the switch position (left or right) according to the impedance of the speakers in your system. Be sure to move this switch only when this unit is in the standby mode.

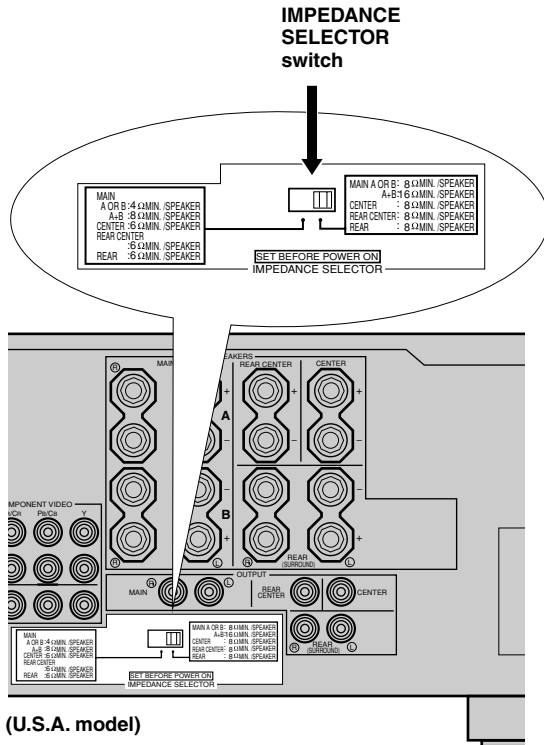

Switch position	Speaker	Impedance level
Left	Main	If you use one set of main speakers, the impedance of each speaker must be 4 Ω or higher. If you use two sets of main speakers, the impedance of each speaker must be 8 Ω or higher.
	Center	The impedance must be 6 Ω or higher.
	Rear Center	The impedance must be 6 Ω or higher.
Right	Main	If you use one set of main speakers, the impedance of each speaker must be 8 Ω or higher. If you use two sets of main speakers, the impedance of each speaker must be 16 Ω or higher. [Canada model only] The impedance of each speaker must be 8 Ω or higher.
		Center
	Rear Center	The impedance must be 8 Ω or higher.
	Rear	The impedance of each speaker must be 8 Ω or higher.

CONNECTIONS

Before connecting components

CAUTION

Do not connect this unit or other components to the mains power until all connections between the components have been completed.

- Be sure all connections are made correctly, that is to say L (left) to L, R (right) to R, “+” to “+” and “-” to “-”. Some components require different connection methods and have different jack names. Refer to the operation instructions for each component to be connected to this unit.
- When you connect other YAMAHA audio components (such as a tape deck, MD recorder and CD player or changer), connect them to the jack with the same number labels as 1, 3, 4 etc. YAMAHA applies this labeling system to all its products.
- After you have completed all connections, check them again to make sure they are correct.
- The name of jack corresponds to input selector.

Connecting to digital jacks

This unit has digital jacks for direct transmission of digital signals through either coaxial or fiber optic cables. You can use the digital jacks to input PCM, Dolby Digital and DTS bitstreams. To enjoy multi-channel sound track of DVD software, etc. with DSP effect, you need to make digital connection. All digital input jacks are acceptable for 96-kHz sampling digital signals.

Note

- The OPTICAL jacks on this unit conform to the EIA standard. If you use a fiber optic cable that does not conform to this standard, this unit may not function properly.

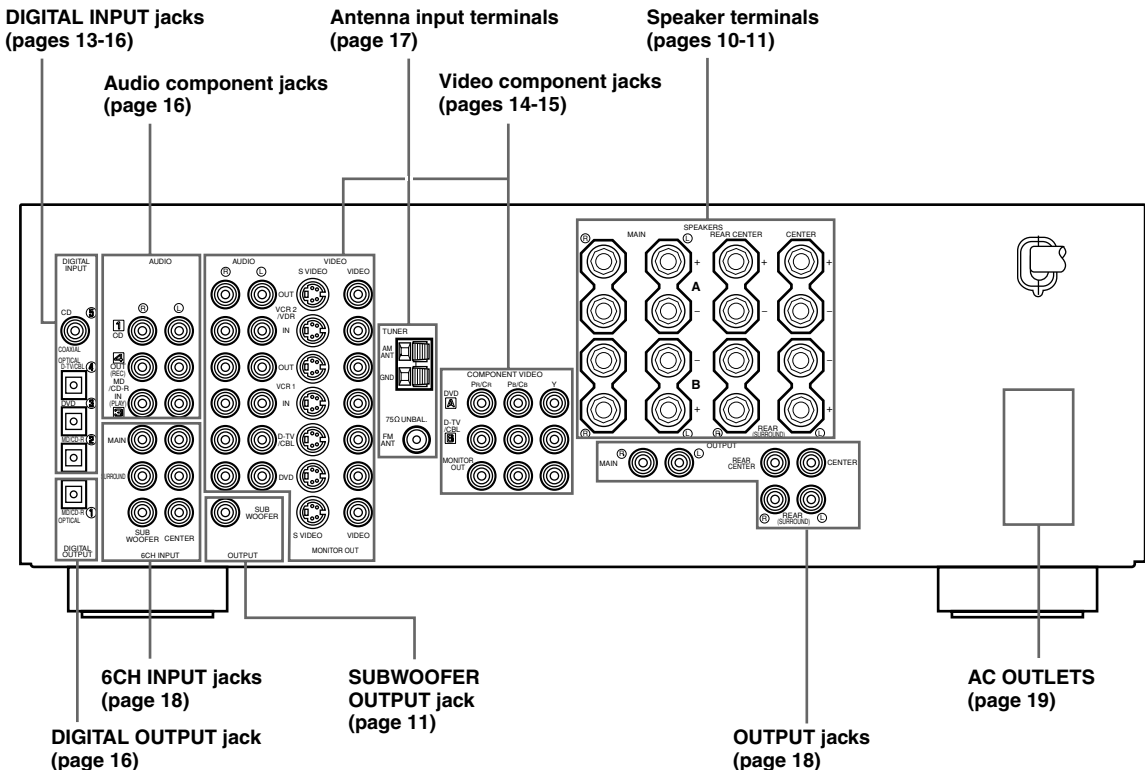

Connecting video components

Refer to the connection examples on the next page.

Types of video jacks

There are three types of video jacks as follows:

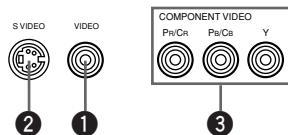

1 VIDEO jack

Conventional composite video signal.

2 S VIDEO jack

Transmits color and luminance separately and achieves high-quality color reproduction.

3 COMPONENT VIDEO jacks

Transmit color difference (Pb/Cb, Pr/Cr) and luminance separately and provide the best quality picture.

- Each type of video jack works independently. Signals input through the composite video, S-video and component jacks are only output through the corresponding composite video, S-video, and component jacks.
- Use a commercially available cable specified for connecting each type of jacks.
- The description of the component video jacks may differ depending on the component (e.g. Y, Cb, Cr/Y, Pb, Pr/Y, B-Y, R-Y etc.). When using these jacks, refer also to the operation instructions for the component being connected.

Connecting a video monitor

Connect the video input jack on your video monitor to the MONITOR OUT VIDEO jack.

Note

- If you connect this unit with a source component using S-video (or Component video) jacks, you also need to connect your video monitor using S-video (or Component video) jacks.

Connecting a DVD player/digital TV/cable TV

Connect the optical digital audio signal output jack on your component to the DIGITAL INPUT jack and connect the video signal output jack on the component to the VIDEO jack on this unit.

Then connect AUDIO jacks on your component to the AUDIO jacks on this unit.



- If your video component has an S-video output or component video output, connect the S-video signal output jack on the component to the S VIDEO jack or connect the component video signal output jacks on the component to the COMPONENT VIDEO jacks.
- The AUDIO jacks are available for a video component which does not have optical digital output jack. However, multi-channel reproduction cannot be obtained with audio signals input from AUDIO jacks.

Connecting a game console or camcorder

Connect the optical digital audio signal output jack on your video component to the OPTICAL jack on the front panel and connect video signal output jack on the component to the VIDEO jack on the front panel.



- If your video component has an S-video output, connect the S-video signal output jack on the component to the S VIDEO jack.
- The AUDIO jacks are available for a video component such as a camcorder which does not have optical digital output jack.

Connecting a VCR or DVR (digital video recorder)

Connect the audio signal input jacks on your video component to the AUDIO OUT jacks and connect the video signal input jack on the video component to the VIDEO OUT jack on this unit for picture recording. Connect the audio signal output jacks on your component to the AUDIO IN jacks and connect the video signal output jack on the component to the VIDEO IN jack on this unit to play a source from your recording component. Second VCR or digital video recorder can be connected using VCR 2/DVR jacks.



- If your video component has an S-video input, connect the S-video signal input jack on the component to the S VIDEO OUT jack.
- If your video component has an S-video output, connect the S-video signal output jack on the component to the S VIDEO IN jack.

Notes

- Once you have connected a recording component to this unit, keep its power turned on while using this unit. If the power is off, this unit may distort the sound from other components.
- S-video and component video signals pass independently through this unit's video circuit. Make sure to connect this unit to both a source component and a recording component using the video jacks of the same system.

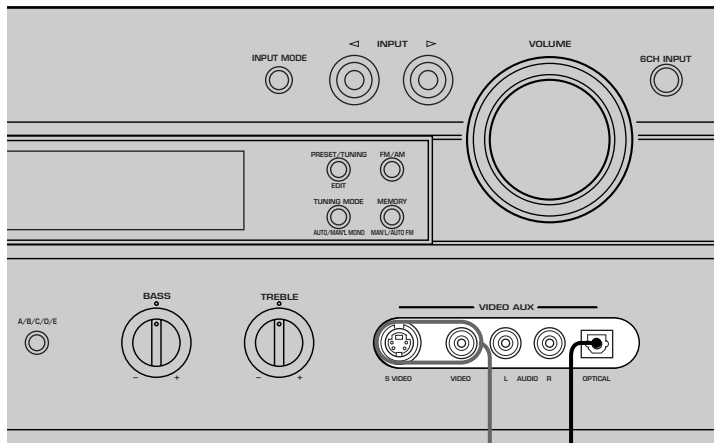
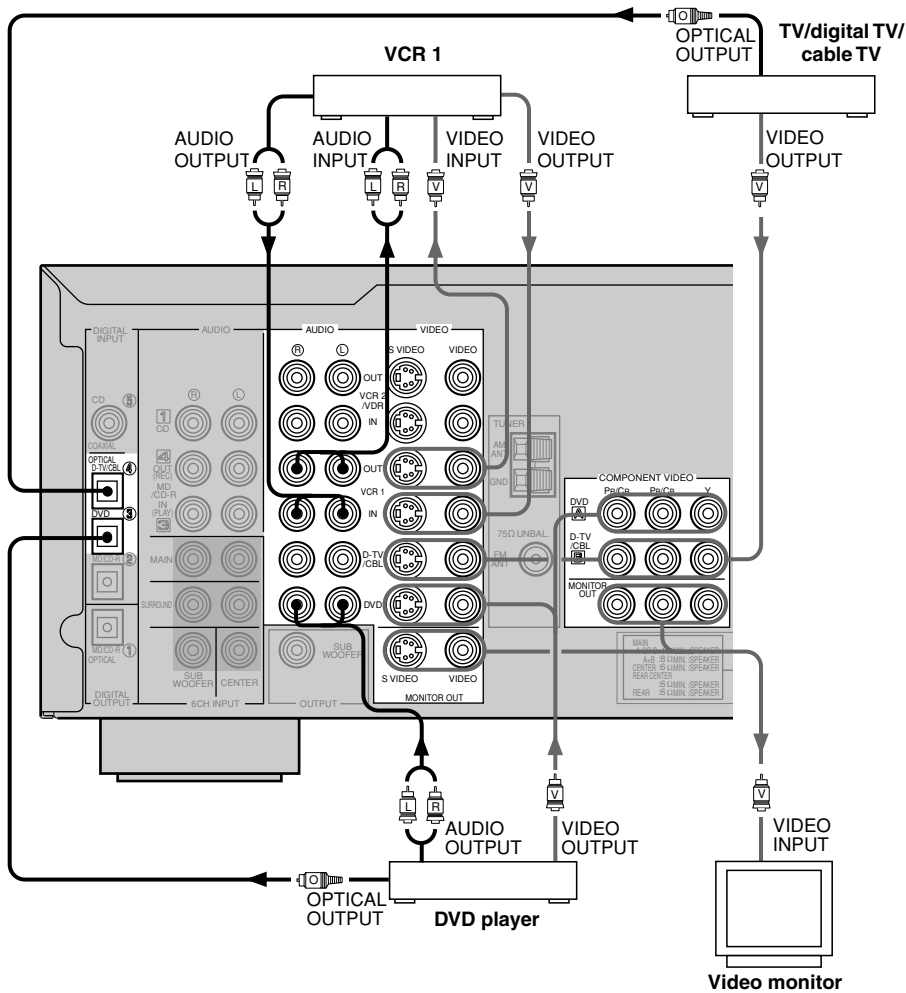

- indicates signal direction
- L— indicates left analog cables
- R— indicates right analog cables
- O— indicates optical cables
- V— indicates video cables

Connecting audio components

■ Connecting a CD player

Connect the coaxial digital output jack on your CD player to the DIGITAL INPUT CD jack.



- The AUDIO jacks are available for a CD player which does not have coaxial digital output jack.

■ Connecting a CD recorder or MD recorder

Connect the optical digital signal input jack on your CD recorder or MD recorder to the DIGITAL OUTPUT MD/CD-R jack for digital recording.

Connect the optical digital output jack on your CD recorder or MD recorder to the DIGITAL INPUT MD/CD-R jack to play a source from your recording component.



- The AUDIO jacks are available for an CD recorder or MD recorder which does not have optical digital input or output jack.

Notes

- Once you have connected a recording component to this unit, keep its power turned on while using this unit. If the power is off, this unit may distort the sound from other components.
- DIGITAL OUTPUT jack and analog OUT (REC) jacks are independent. Only digital signals are output from DIGITAL OUTPUT jack and analog signals from OUT (REC) jacks.

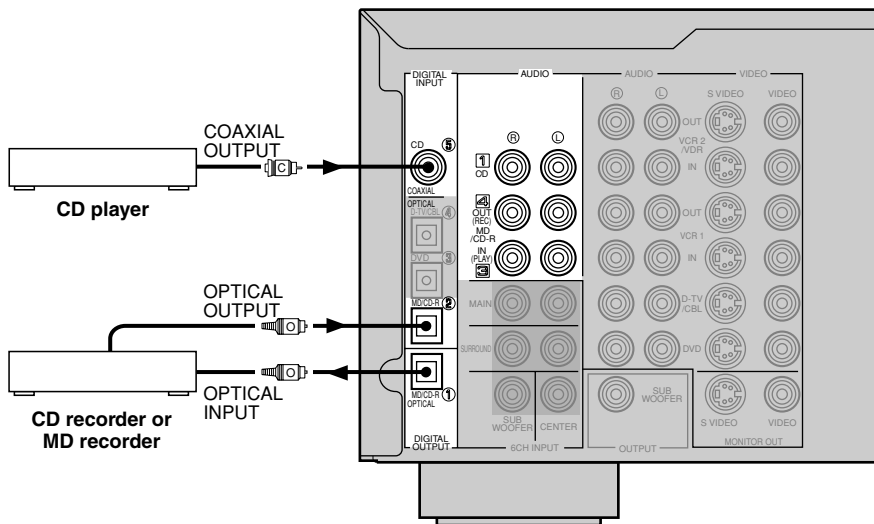

→ indicates signal direction

—|C|— indicates coaxial cables

—|O|— indicates optical cables

Connecting the antennas

Both AM and FM indoor antennas are included with this unit. In general, these antennas should provide sufficient signal strength.

Connect each antenna correctly to the designated terminals.

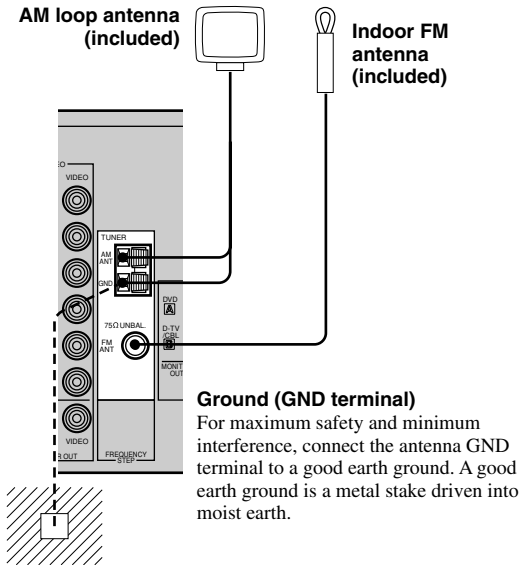

75-ohm/300-ohm antenna adapter (U.K. model)

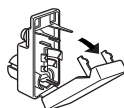
- 1** 

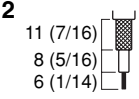
Open the cover of the included 75-ohm/300-ohm antenna adapter.
- 2**  Unit: mm (inch)
11 (7/16)
8 (5/16)
6 (1/4)

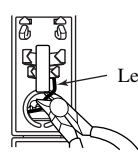
Cut the external sleeve of the 75-ohm coaxial cable and prepare it for connection.
- 3**  Lead wire

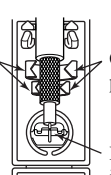
Cut the lead wire and remove it.
- 4**  Clamp with pliers. Insert the wire into the slot.

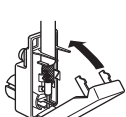
Insert the cable wire into the slot, and clamp it with pliers.
- 5** 

Snap the cover into place.

Connecting the AM loop antenna

- 1** Set up the AM loop antenna, then connect it.

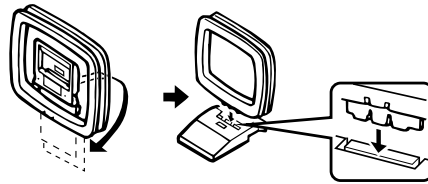

- 2** Press and hold the tab to insert the AM loop antenna lead wires into the AM ANT and GND terminals.

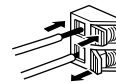

- 3** Orient the AM loop antenna for the best reception.



Notes

- The AM loop antenna should be placed away from this unit.
- The AM loop antenna should always be connected, even if an outdoor AM antenna is connected to this unit.

A properly installed outdoor antenna provides clearer reception than an indoor one. If you experience poor reception quality, an outdoor antenna may improve the quality. Consult the nearest authorized YAMAHA dealer or service center about the outdoor antennas.

FREQUENCY STEP switch (China and General models)



Because the interstation frequency spacing differs in different areas, set the FREQUENCY STEP switch (located on the rear panel) according to the frequency spacing in your area.

North, Central and South America:
100 kHz/10 kHz

Other area: 50 kHz/9 kHz

Before setting this switch, disconnect the AC power plug of this unit from the AC outlet.

Connecting an external amplifier

If you want to increase the power output to the speakers, or want to use another amplifier, connect an external amplifier to the OUTPUT jacks as follows.

Note

- When RCA pin plugs are connected to the OUTPUT jacks for output to an external amplifier, signals are output from the SPEAKERS terminals as well.

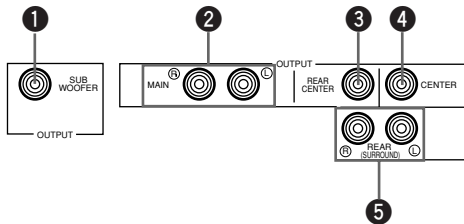

1 SUBWOOFER jack

When using a subwoofer with built-in amplifier, including the YAMAHA Active Servo Processing Subwoofer System, connect the input jack of the subwoofer system to this jack. Low bass signals distributed from the main, center and/or rear channels are directed to this jack in accordance with your SPEAKER SET selections. The LFE (low-frequency effect) signals generated when Dolby Digital or DTS is decoded are also directed to this jack in accordance with your SPEAKER SET selections.

Notes

- The cut-off frequency of the SUBWOOFER jack is 90 Hz.
- If you do not use a subwoofer, designate the signals to the main left and right speakers by changing the settings of SPEAKER SET item "1E BASS" on the SET MENU.
- Use the control on the subwoofer to adjust its volume level. It is also possible to adjust the volume level by using this unit's remote control (see "ADJUSTING THE LEVEL OF THE EFFECT SPEAKERS" on page 49).

2 MAIN jacks

Main channel line output jacks.

Note

- The signals output through these jacks are affected by the BASS and TREBLE settings.

3 REAR CENTER jack

Rear center channel line output jack.

4 CENTER jack

Center channel line output jack.

5 REAR (SURROUND) jacks

Rear channel line output jacks.

Connecting an external decoder

This unit is equipped with 6 additional input jacks (MAIN left and right, CENTER, SURROUND left and right, and SUBWOOFER) for discrete multi-channel input from an external decoder, sound processor, or pre-amplifier.

Connect the output jacks on your external decoder to the 6CH INPUT jacks. Be sure to match the left and right outputs to the left and right input jacks for the main and surround channels.

Notes

- When you select 6CH INPUT as the input source, this unit automatically turns off the digital sound field processor, and you cannot listen to DSP programs.
- When you select 6CH INPUT as the input source, settings of "1 SPEAKER SET" on the SET MENU do not apply (except for "1F MAIN Lv").

Connecting the power supply cords

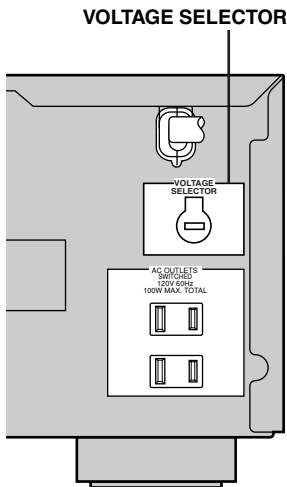

(General model)

■ Connecting the AC power cord

Plug in this unit to the wall outlet.

■ AC OUTLETS (SWITCHED)

U.S.A., Canada, China, Europe, Singapore and General models 2 OUTLETS

U.K. and Australia model 1 OUTLET

Use these outlets to connect the power cords from your components to this unit. The power to the AC OUTLETS is controlled by this unit's STANDBY/ON (or SYSTEM POWER and STANDBY). These outlets will supply power to any source component connected to this unit whenever this unit is turned on. The maximum power (total power consumption of components) that can be connected to the AC OUTLETS varies depending on the area which it was purchasing.

China and General models 50 W

Other models 100 W

■ VOLTAGE SELECTOR (China and General models)

The VOLTAGE SELECTOR on the rear panel of this unit must be set for your local main voltage BEFORE plugging into the AC main supply. Voltages are 110/120/220/240 V AC, 50/60 Hz.

Turning on the power

When all connections are complete, turn on the power of this unit.

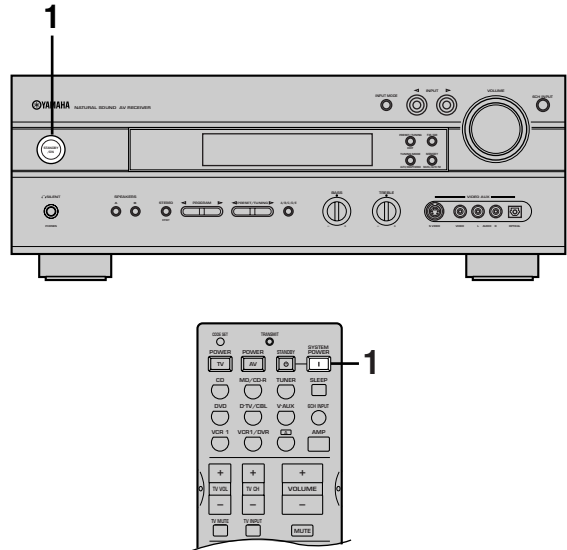

- 1 Press **STANDBY/ON** (**SYSTEM POWER** on the remote control) to turn on the power of this unit.



Front panel

or



Remote control

The level of the main volume, and then the current DSP program name appear on the front panel display.

- 2 Turn on the video monitor connected to this unit.

SPEAKER MODE SETTINGS

This unit has 6 SPEAKER SET items on the SET MENU that you must set according to the number of speakers in your configuration and their size. The following table summarizes these SPEAKER SET items, and shows the initial settings as well as other possible settings.

If the initial settings shown in the following table are not appropriate for your speaker configuration, see “1 SPEAKER SET” on pages 41-43 to change the settings.

Summary of SPEAKER SET items 1A through 1F

Item	Description	Possible settings (default setting indicated in bold)
1A CENTER	Sets center speaker availability and size.	LRG /SML/NON
1B MAIN	Sets main speaker size.	LARGE /SMALL
1C REAR LR	Sets rear L/R speakers availability and size.	LRG /SML/NON
1D REAR CT	Sets rear center speaker availability and size.	LRG /SML/NON
1E BASS	Sets the speaker(s) to be used to output low bass signals.	SWFR/ MAIN / BOTH
1F MAIN Lv	Sets the main speaker level.	Nrm (Normal) /-10 dB

ADJUSTING SPEAKER OUTPUT LEVELS

This section explains how to adjust speaker output levels using the test tone generator. When this adjustment is complete, the output level heard at the listening position should be the same from each speaker. This is important for best performance of the digital sound field processor, and the various decoders (Dolby Digital, Dolby Pro Logic, Dolby Pro Logic II and DTS).

Note

- Since this unit cannot enter the test mode while headphones are connected to this unit, be sure to unplug the headphones from the PHONES jack when using the test tone.

Before you begin

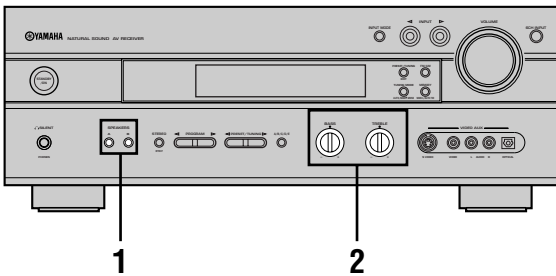

- 1 Press SPEAKERS A or B to select the main speakers to be used.**

If you are using two sets of the main speakers, press both A and B.

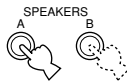

- 2 Set the BASS and TREBLE controls on the front panel to the center position.**

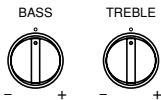

Using the test tone

Use the test tone to balance the output levels of the speakers. The adjustment of each speaker output level should be made at your listening position using the remote control.

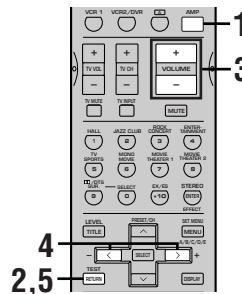
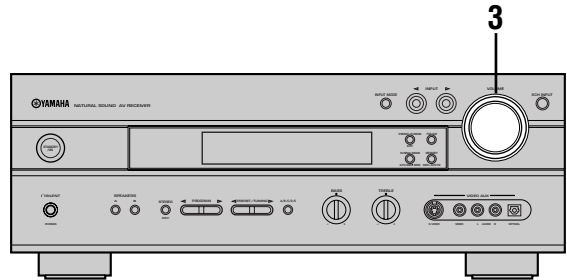

- 1 Press AMP.**



- 2 Press TEST to output the test tone.**



- 3 Adjust the volume of this unit so you can hear the test tone.**

The test tone is heard (in order) from the main left speaker, center speaker, main right speaker, rear right speaker, rear center, rear left speaker, and the subwoofer. The tone is produced for 2.5 seconds from each speaker.

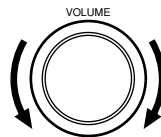

Front panel

or

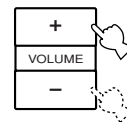

Remote control

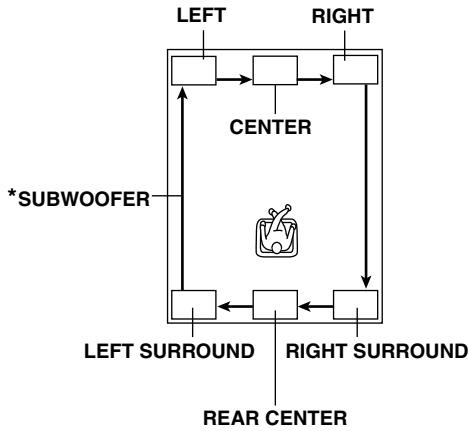

* Subwoofer test tone is output after the rear left speaker (LEFT SURROUND).

The front panel display shows which speaker is outputting the test tone.

Note

- If the test tone cannot be heard, turn down the volume, set this unit to standby mode and check the speaker connections.

4 Adjust the level of the effect speakers using </> so that it matches the level of the main speakers.

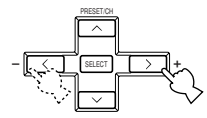

While adjusting, the test tone is heard from the selected speaker.

Note

- To adjust the level of the main speakers, use VOLUME knob (or VOLUME +/- on the remote control).

5 When adjustment is complete, press TEST to stop the test tone.



Notes

- If "1A CENTER" on the SET MENU is set to NON, the center channel sound is automatically output from the main left and right speakers.
- If "1C REAR LR" on the SET MENU is set to NON, the output level of the rear left, right and center speakers cannot be adjusted in step 4. The test tone will be circulated skipping the rear left and right speakers and the rear center speaker.
- If "1D REAR CT" on the SET MENU is set to NON, the output level of the rear center speaker cannot be adjusted in step 4. The test tone will be circulated skipping the rear center speaker.
- If "1E BASS" on the SET MENU is set to MAIN, the test tone will be circulated skipping the subwoofer.



- It is not necessary to readjust the speaker levels once they are set (as long as you do not change the speakers). You can enjoy listening to or watching the input source at the desired volume simply by adjusting the VOLUME knob (or VOLUME +/- on the remote control).
- If the output level of the effect speakers (center, rear left, rear right, and rear center) cannot be increased enough to match the level of the main speakers, set "1F MAIN Lv" on SET MENU to -10 dB (see page 43). This setting decreases the main speaker output level to about one-third of the normal level. After you have set "1F MAIN Lv" on the SET MENU to -10 dB, adjust the levels for the center and rear speakers again.

BASIC PLAYBACK

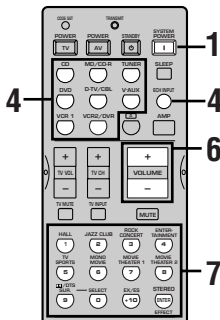
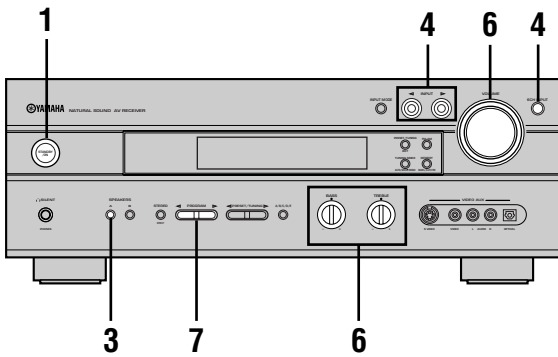

1 Press **STANDBY/ON (SYSTEM POWER)** on the remote control to turn on the power.

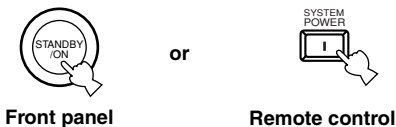

2 Turn on the video monitor connected to this unit.

3 Press **SPEAKERS A** or **B** to select the main speakers to be used.

If you are using two sets of main speakers, press both A and B.

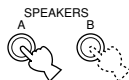

4 Press **INPUT** </> repeatedly (one of the input selector buttons on the remote control) to select the input source.

The selected input source name and input mode appear on the front panel display for a few seconds.

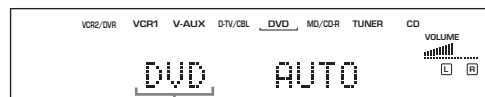
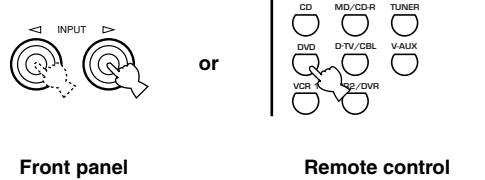

Selected input source

To select the audio source connected to the **6CH INPUT**

(When combining with a video source)

- You need to select the input to which the video source component is connected before selecting audio source. Press **6CH INPUT** until “6CH INPUT” appears on the front panel display.

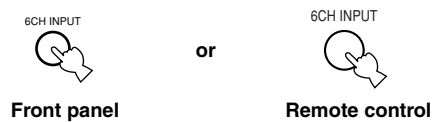

6CH INPUT

Note

- If “6CH INPUT” is shown on the front panel display, no other source can be played. To select another input source, first press **6CH INPUT** to turn off “6CH INPUT” from the front panel display.

5 Start playback or select a broadcast station on the source component.

Refer to the operation instructions for the component.

6 Adjust the volume to the desired level.

The volume level is displayed digitally.

Example: -70 dB

Control range: VOLUME MUTE (minimum) to 0 dB (maximum)

The volume level indicator also shows the current volume level as a bar graph.

If desired, use BASS and TREBLE. These controls only effect the sound from the main speakers.

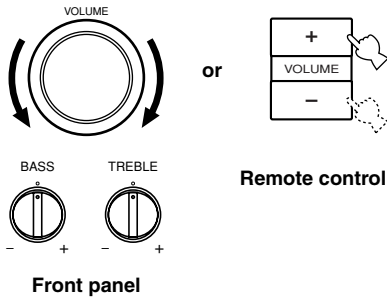

Notes

- If you increase or decrease the high-frequency or the low-frequency sound to an extreme level, the tonal quality from the center and rear speakers may not match that of the main left and right speakers.
- If you have connected a recording component to the VCR 1 OUT, VCR 2/DVR OUT, or MD/CD-R OUT jacks, and you notice distortion or low volume during playback of other components, try turning the recording component on.

7 Select a DSP program if desired.

Use PROGRAM </> (DSP program buttons on the remote control) to select a DSP program. See pages 29 to 33 for details about DSP programs.

When using the remote control, press AMP before selecting a DSP program.

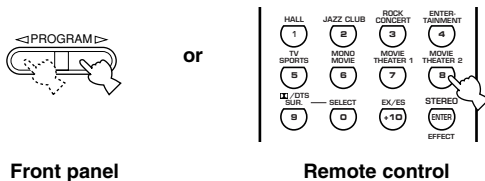

■ BGV (background video) function

The BGV function allows you to enjoy video images from a video source together with sounds from an audio source. For example, you can enjoy listening to classical music while having beautiful scenery from a video source on the video monitor.

Select a source from the video group, then select a source from the audio group using the input selector buttons on the remote control. BGV selections cannot be made with INPUT </> on the front panel.

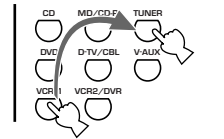

■ To mute the sound

Press MUTE on the remote control.

To resume the audio output, press MUTE again.



- You can also cancel mute by pressing VOLUME +/-, etc.
- During muting, the "MUTE" indicator flashes on the front panel display.

■ When you have finished using this unit

Press STANDBY/ON (STANDBY on the remote control) to set this unit in the standby mode.

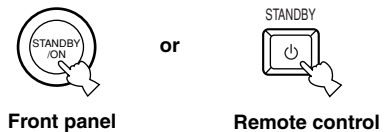

Input modes and indications

This unit comes with a variety input jacks. You can select the type of input signals you desire.

Each time you turn on the power of this unit, the input mode is set according to “8 INPUT MODE” setting on the SET MENU (see page 45 for details).

Press INPUT MODE (the input selector button that you have pressed to select the input source on the remote control) repeatedly until the desired input mode is shown on the front panel display.

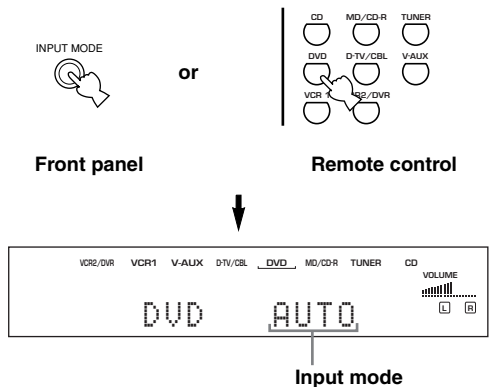

AUTO: In this mode, the input signal is selected automatically as follows:

- 1) Digital signal
- 2) Analog signal

DTS: In this mode, only the digital input signal encoded with DTS is selected, even if another signal is input at the same time.

ANALOG: In this mode, only the analog input signal is selected, even if a digital signal is input at the same time.

Notes

- When AUTO is selected, this unit automatically determines the type of signal. If this unit detects a Dolby Digital or DTS signal, the decoder automatically switches to the appropriate setting.
- When playing a disc encoded with Dolby Digital or DTS on some LD or DVD players, the sound output delays for a moment when playback resumes after a search because the digital signal is selected again.
- When playing a LD source that has not been digitally recorded, the sound may not be output for some LD players. In this case, set the input mode to ANALOG.

Notes on 96-kHz sampling digital signals

The digital input jacks of this unit can handle 96-kHz sampling digital signals. Note the following when 96-kHz sampling digital signal is input to this unit:

- DSP programs cannot be selected.
- Sound will be output as 2-channel stereo from only the main left and right speakers. (There may be sound output from the subwoofer depending on the SPEAKER MODE settings on the SET MENU.) Therefore, the level of the effect speakers cannot be adjusted while listening to such a source.

Notes on playing DTS-CD/LDs

- If the digital output data of the player has been processed in any way, you may not be able to perform DTS decoding even if you make a digital connection between this unit and the player.
- If you play a source encoded with a DTS signal and set the input mode to ANALOG, this unit may reproduce the noise of an unprocessed DTS signal. In this case, connect the source to a digital input jack and set the input mode to AUTO or DTS.
- If you switch the input mode to ANALOG while playing a source encoded with a DTS signal, this unit reproduces no sound.
- If you play a source encoded with a DTS signal with the input mode set to AUTO;
 - This unit automatically switches to the DTS-decoding mode (The “**dts**” indicator lights up) after having detected the DTS signal. When playback of the DTS source is completed, the “**dts**” indicator may flash. While this indicator is flashing, only DTS source can be played. If you want to play a normal PCM source soon, set the input mode back to AUTO.
 - When the input mode is set to AUTO and a search or skip operation is performed during playback of a DTS source, the “**dts**” indicator may flash. If this status continues for longer than 30 seconds, this unit will automatically switch from “DTS-decoding” mode to PCM digital signal input mode. The “**dts**” indicator will turn off.

Selecting a sound field program

You can enhance your listening experience by selecting a DSP program. For details about each program, see pages 29 to 33.

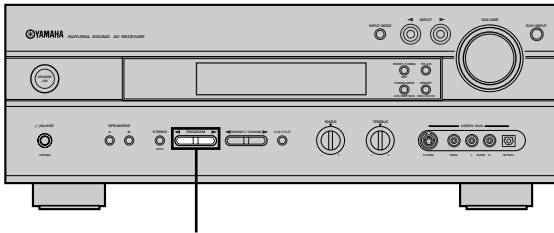

PROGRAM </>

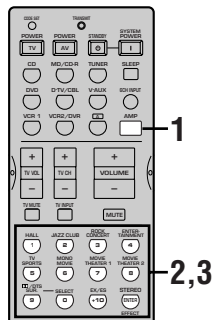

1 Press AMP.



2 Press one of the DSP program buttons on the remote control to select the desired program.

The name of the selected program appears on the front panel display.

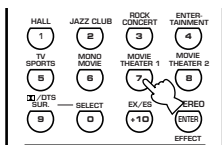

Program name

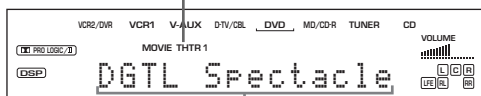

Sub-program name

3 After selecting the desired program, press the same button repeatedly to select the desired sub-program if available.

Example: Pressing MOVIE THEATER 1 repeatedly switches the sub-program between "Sci-Fi" and "Spectacle".

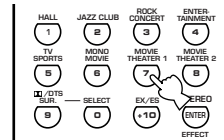

Program name

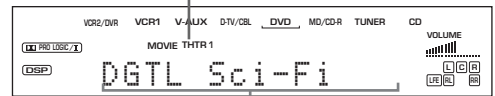

Sub-program name

Notes

- There are 9 programs with sub-programs available with this unit. However, the selection depends on the input signal format and not all sub-programs can be used with all input signal formats.
- The digital sound field processor cannot be used when a source connected to the 6CH INPUT jacks of this unit is selected or when 96-kHz sampling digital signals are input to this unit.
- The acoustics of your listening room affect the DSP program. Minimize the sound reflections in your room to maximize the effect created by the program.
- When you select an input source, this unit automatically selects the last DSP program used with that source.
- When you set this unit in the standby mode, the current source and DSP program are memorized and are automatically selected when you turn on the power again.
- If a Dolby Digital or DTS signal is input when the input mode is set to AUTO, the DSP program (No. 7–9) automatically switches to the appropriate decoding program.
- When a monaural source is being played with PRO LOGIC/Normal or PRO LOGIC/Enhanced, or PRO LOGIC II Movie, no sound will be heard from the main speakers and the rear speakers. Sound can only be heard from the center speaker. (If "1A CENTER" on the SET MENU is set to NON, the center channel sound is output from the main speakers.)



- You can also select DSP program by pressing PROGRAM </> on the front panel.
- Select a program based on your listening preference. Program names are just for reference.

■ Selecting PRO LOGIC II

You can enjoy the 2-channel sources decoded into five or six discrete channels by selecting PRO LOGIC II in program No. 9.

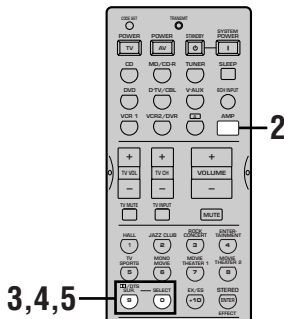
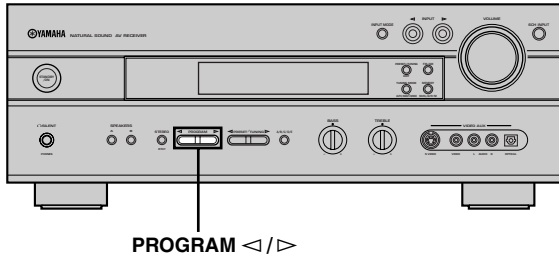

4 Press SELECT repeatedly to select the decoder; PRO LOGIC or PRO LOGIC II.

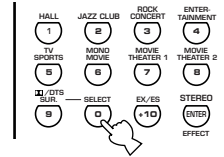

5 After selecting on the decoder (PRO LOGIC II), select the mode appropriate for the source by pressing **DD/DTS SUR**.

The selection switches as follow;

PRO LOGIC II Movie ↔ PRO LOGIC II Music

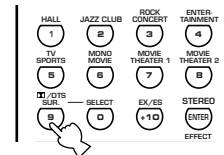

- You can select PRO LOGIC, PRO LOGIC II Movie, and PRO LOGIC II Music by pressing PROGRAM </> on the front panel repeatedly.

1 Select a 2-channel source and start playback on the source component.

2 Press AMP.



3 Press **DD/DTS SUR**.

The previously selected sub program appears on the front panel display.

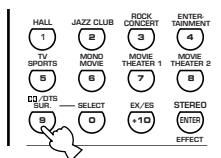

Remote control

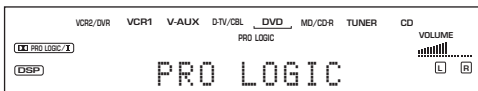

■ Playing Dolby Digital Surround EX or DTS ES software

Press EX/ES to turn on the Dolby Digital EX or DTS-ES compatible decoder.

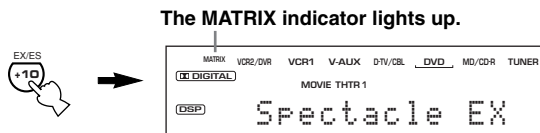

The MATRIX indicator lights up.

The display changes AUTO → Matrix6.1 → OFF each time the EX/ES button is pressed.

AUTO: This mode automatically switches Dolby Digital EX and DTS-ES compatible depending on the signal. Rear center speaker does not work for 5.1 channel sources.

Matrix6.1: This setting produces 6-channel playback of the input source using the Dolby Digital EX or DTS-ES compatible decoder. The rear center speaker can be used when playing a 5.1-channel source.

OFF: Rear center speaker does not work in this setting. (Except for when the DSP program “6ch” is selected.)

Notes

- No sound will be output from the rear center speaker if you have set “1C REAR LR” or “1D REAR CT” on the SET MENU to NON.
- The setting becomes AUTO once this unit turns into standby mode.
- Some Dolby Digital Surround EX or DTS ES software may not contain the signal that is necessary for this unit to switch to the Dolby Digital EX or DTS-ES compatible decoding mode. To turn on the decoder when playing such a source, select “Matrix6.1”.

■ Virtual CINEMA DSP

With Virtual CINEMA DSP, you can enjoy all DSP programs without rear speakers. It creates virtual speakers to reproduce a natural sound field.

You can listen to virtual CINEMA DSP by setting “1C REAR LR” in the SET MENU to NON. Sound field processing changes to VIRTUAL CINEMA DSP automatically.

Note

- This unit is not set in the virtual CINEMA DSP mode even if “1C REAR LR” is set to NON in the following cases:
 - when the 6ch Stereo, DOLBY DIGITAL Normal, Pro Logic Normal, Pro Logic II, or DTS Normal program is selected;
 - when the sound effect is turned off;
 - when 6CH INPUT is selected as the input source;
 - when 96-kHz sampling digital signals are input to this unit;
 - when using the test tone; or
 - when connecting the headphones.

■ SILENT CINEMA DSP

You can enjoy a powerful sound field similar to what you could expect from actual speakers with SILENT CINEMA DSP. You can listen to SILENT CINEMA DSP by connecting your headphones to the PHONES jack while the digital sound field processor is on. Enjoy all the DSP program using the headphones. The “SILENT” indicator lights up on the front panel display. (When sound effects are off, you listen to the source with normal stereo reproduction.)

Notes

- This feature is not available when 6CH INPUT is selected or 96-kHz sampling digital signals are input to this unit.
- The sound of LFE channel will be mixed and output from the headphone.

■ Normal stereo reproduction

Press STEREO to turn off the sound effect for normal stereo reproduction.

Press STEREO again to turn the sound effect back on.

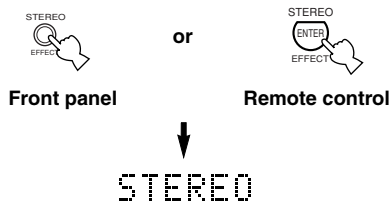

Notes

- If you turn off the sound effects, no sound is output from the center speaker, rear speakers, or rear center speaker.
- If you turn off the sound effects while a Dolby Digital or DTS signal is being output, the dynamic range of the signal is automatically compressed and the sounds of the center and rear speaker channels are mixed and output from the main speakers.
- The volume may be greatly reduced when you turn off the sound effects or if you set “4 D. RANGE” on the SET MENU to MIN. In this case turn on the sound effect.
- The sound of LFE channel will be directed to the main left and right or the subwoofer (or both) channels depending on the setting of “1E BASS” on the SET MENU.



During stereo reproduction, you can display information such as the type, format and sampling frequency of the signal input from the components connected to this unit.

(While playing a source)

1 Press AMP.

2 Press √ to display the information about the input signal.

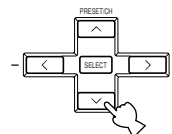

DIGITAL SOUND FIELD PROCESSING (DSP)

Understanding sound fields



A sound field is defined as the “characteristic sound reflections of a particular space.” In concert halls and other music venues, we hear early reflections and reverberations as well as the direct sound produced by the artist(s). The variations in the early reflections and other reverberations among the different music venues is what gives each venue its special and recognizable sound quality.

YAMAHA sent teams of sound engineers all around the world to measure the sound reflections of famous concert halls and music venues, and collect detailed sound field information such as the direction, strength, range, and delay time of those reflections. Then we stored this enormous amount of data in the ROM chips of this unit.

■ Recreating a sound field

Recreating the sound field of a concert hall or an opera house requires localizing the virtual sound sources in your listening room. The traditional stereo system that uses only two speakers is not capable of recreating a realistic sound field. YAMAHA's DSP requires four effect speakers to recreate sound fields based on the measured sound field data. The processor controls the strength and delay time of the signals output from the four effect speakers to localize the virtual sound sources and fully encompass the listener.

Hi-Fi DSP programs

The following list gives you a brief description of the sound fields produced by each of the DSP programs. Keep in mind that most of these are precise digital recreations of actual acoustic environments.

No.	Program	Features
1	CONCERT HALL	A large round concert hall with a rich surround effect. Pronounced reflections from all directions emphasize the extension of sounds. The sound field has a great deal of presence, and your virtual seat is near the center, close to the stage.
2	JAZZ CLUB	This is the sound field at stage front in “The Bottom Line”, a famous New York jazz club, that seats up to 300 people. Its wide left to right seating arrangement offers a real and vibrant sound.
3	ROCK CONCERT	The ideal program for lively, dynamic rock music. The data for this program was recorded at LA's “hottest” rock club. The listener's virtual seat is at the center-left of the hall.
4	ENTERTAINMENT/ Disco	This program recreates the acoustic environment of a lively disco in the heart of a big city. The sound is dense and highly concentrated. It is also characterized by a high-energy, “immediate” sound.
	ENTERTAINMENT/ 6ch Stereo	Using this program increases the listening position range. This is a sound field suitable for background music at parties, etc.

CINEMA-DSP

Sound design of CINEMA-DSP

Filmmakers intend for the dialog to be located right on the screen, the effect sound a little farther back, the music spread even farther back, and the surround sound around the listener. Of course, all of these sounds must be synchronized with the images on the screen.

CINEMA-DSP is an upgraded version of YAMAHA DSP specially designed for movie soundtracks. CINEMA-DSP integrates the DTS, Dolby Digital, and Dolby Pro Logic surround sound technologies with YAMAHA DSP sound field programs to provide a surround sound field. It recreates comprehensive movie sound design in your audio room. In CINEMA-DSP sound field programs, YAMAHA's exclusive DSP processing is added to the Main left and right, and Center channels, so the listener can enjoy realistic dialogue, depth of sound, smooth transition between sound sources, and a surround sound field that goes beyond the screen.

When a DTS or Dolby Digital signal is detected, the CINEMA-DSP sound field processor automatically chooses the most suitable sound field program for that signal.

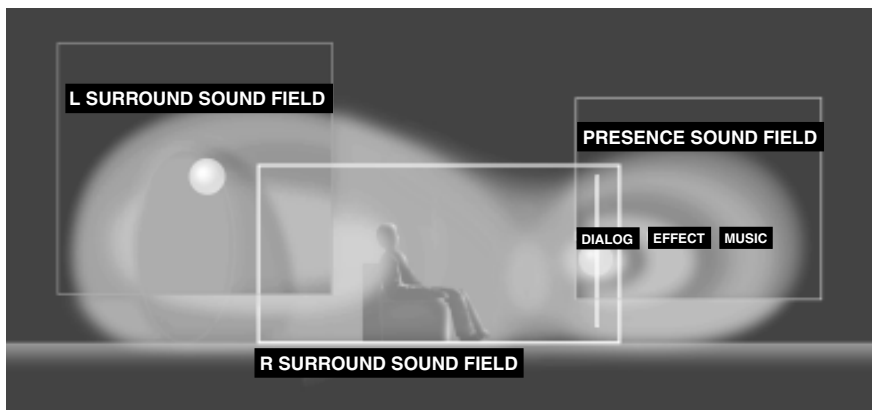

In addition to the DSP, this unit is equipped with a variety of precise decoders; Dolby Pro Logic decoder for Dolby Surround sources, Dolby Pro Logic II decoder for Dolby Surround and 2-channel sources, Dolby Digital/DTS decoder for multi-channel sources and Dolby Digital EX or DTS-ES compatible decoder for adding a rear center channel. You can select CINEMA-DSP programs to optimize these decoders and the DSP sound patterns depending on the input source.

The 6-channel soundtracks found on 70-mm film produce precise sound field localization and rich, deep sound without using matrix processing. This unit's MOVIE THEATER programs provide the same quality of sound and sound localization that 6-channel soundtracks do. The built-in Dolby Digital or DTS decoder brings the professional-quality sound designed for movie theaters into your home. With this unit's MOVIE THEATER programs, you can use Dolby Digital or DTS technology to recreate a dynamic sound that gives you the feeling of being in a public theater.

■ Dolby Digital/DTS + DSP sound field effect

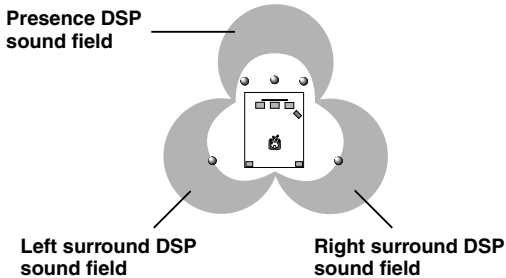

These programs use YAMAHA's tri-field DSP processing on each of the Dolby Digital or DTS signals for the front, left surround, and right surround channels. This processing enables this unit to reproduce the immense sound field and surround expression of a Dolby Digital- or DTS-equipped movie theater without sacrificing the clear separation of all channels.

■ Dolby Digital EX/DTS-ES compatible + DSP sound field effect

These programs provide you with the maximum experience of the spacious surround effects by adding an extra rear center DSP sound field created from the rear center channel.

■ Dolby Pro Logic + DSP sound field effect

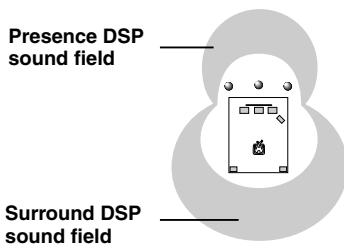

Most movie software has 4-channel (left, center, right, and surround) sound information encoded by Dolby Surround matrix processing and stored on the left and right tracks. These signals are processed by the Dolby Pro Logic decoder. The MOVIE THEATER programs are designed to recreate the spaciousness and delicate nuances of sound that tend to be lost in the encoding and decoding processes.

■ Dolby Pro Logic II

Dolby Pro Logic II decodes Dolby Surround software into 5 discrete full-range channels (3 channels in front and 2 channels in rear). There are 2 modes; MOVIE for movies and MUSIC for 2-channel audio sources.

CINEMA-DSP programs

■ For movie programs: No. 7 to 9

This unit automatically chooses the appropriate decoder and DSP sound field pattern according to the input signal format.

Table of Program Names for Each Input Format

No.	Input Program	2 channel	5.1 channel		6.1 channel *	
		Stereo	DOLBY DIGITAL	DTS	DOLBY DIGITAL EX	DTS-ES compatible
7	MOVIE THEATER 1	70 mm Spectacle	DGTL Spectacle	DTS Spectacle	Spectacle EX	Spectacle ES
		70 mm Sci-Fi	DGTL Sci-Fi	DTS Sci-Fi	Sci-Fi EX	Sci-Fi ES
8	MOVIE THEATER 2	70 mm Adventure	DGTL Adventure	DTS Adventure	Adventure EX	Adventure ES
		70 mm General	DGTL General	DTS General	General EX	General ES
9	DOLBY DIGITAL	—	Normal	—	Dolby D EX	—
		—	Enhanced	—	Enhanced EX	—
	DTS DIGITAL SUR	—	—	Normal	—	DTS-ES
		—	—	Enhanced	—	Enhanced ES
	PRO LOGIC	Normal	—	—	—	—
		Enhanced	—	—	—	—
	PRO LOGIC II	Movie	—	—	—	—
		Music	—	—	—	—

* means the Dolby Digital EX decoder or the DTS-ES compatible decoder is ON.



- If a Dolby Digital signal or DTS signal is input when the input mode is set to AUTO, the DSP program will automatically switch to the Dolby Digital playback sound field or DTS playback sound field.
- If Dolby Digital Surround EX software or DTS ES software is played when AUTO is selected by pressing the EX/ES button on the remote control, the Dolby Digital EX or DTS-ES compatible decoder usually turns on and the corresponding DSP program is selected.
- EX/ES on the remote control can be used to play Dolby Digital or DTS 5.1 channel sources with the rear center speaker. In this case the program name changes to the corresponding name for 6.1 channel.
- When playing a 6.1 channel source with the Dolby Digital EX decoder or the DTS-ES compatible decoder turned off, the program name changes to the corresponding name for 5.1 channel.

Notes

- The “” indicator does not light up when selecting program No. 9 except in Enhanced mode.
- When playing a monaural source with a CINEMA DSP program, the source signal is directed to the center channel, main and rear speakers output effect sounds.

The following list gives you a brief description of the sound fields produced by each of the DSP programs. Keep in mind that most of these are precise digital recreations of actual acoustic environments. Select the DSP program that you feel sounds best regardless of the name and description given for it below.

No.	Program		Features
7	MOVIE THEATER 1	Spectacle	This program creates the extremely wide sound field of a 70-mm movie theater. It precisely reproduces the source sound in detail, making both the video and the sound field incredibly real. This is ideal for any kind of video source encoded with Dolby Surround, Dolby Digital or DTS (especially large-scale movie productions).
		Sci-Fi	This program clearly reproduces dialog and sound effects in the latest sound form of science fiction films, thus creating a broad and expansive cinematic space amid the silence. You can enjoy science fiction films in a virtual-space sound field that includes Dolby Surround, Dolby Digital and DTS-encoded software employing the most advanced techniques.
8	MOVIE THEATER 2	Adventure	This program is ideal for precisely reproducing the sound design of the newest 70-mm and multichannel soundtrack films. The sound field is made to be similar to that of the newest movie theaters, so the reverberations of the sound field itself are restrained as much as possible.
		General	This program is for reproducing sounds from 70-mm and multichannel soundtrack films, and is characterized by a soft and extensive sound field. The presence sound field is relatively narrow. It spatially spreads all around and toward the screen, restraining the echo effect of conversations without losing clarity.
9	Enhanced Mode		This program ideally simulates the multi-surround speaker systems of the 35-mm film theaters. Dolby Pro Logic decoding, Dolby Digital decoding or DTS decoding and digital sound field processing create precise effects without altering the original sound orientation. The surround effects produced by this sound field wrap around the viewer naturally from the back to the left and right, and toward the screen.

■ For audio-video sources: No. 4 to 6

No.	Program	Features
4	ENTERTAINMENT/ Game	This program adds a deep and spatial feeling to video game sounds.
	ENTERTAINMENT/ Concert Video	This program adds a deep and spatial feeling to concert video sounds.
5	TV SPORTS	With this program, you can enjoy watching various TV programs such as news, variety shows, music programs or sports programs. In a stereo broadcast of a sports game, the commentator is oriented at the center position, and the shouts and the atmosphere in the stadium spread on the surround side, while their spread to the rear is properly restrained.
6	MONO MOVIE	This program is provided for reproducing monaural video sources (such as old movies). The program produces the optimum reverberation to create sound depth by using only the presence sound field.

TUNING

Automatic and manual tuning

There are 2 ways to tune; automatic and manual. Automatic tuning is effective when station signals are strong and there is no interference.

Automatic tuning

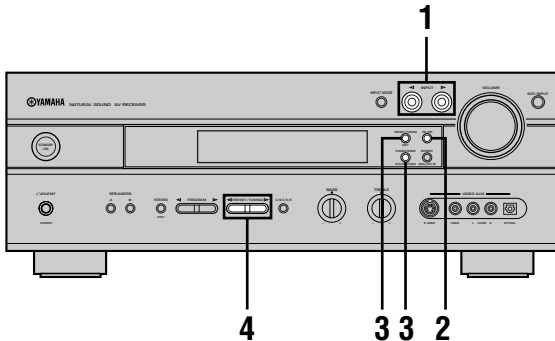

- 1 Press INPUT $\triangleleft/\triangleright$ (TUNER on the remote control) to select TUNER as the input source.

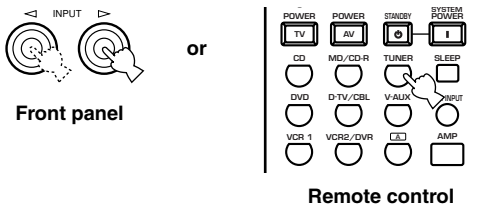

- 2 Press FM/AM to select the reception band. "FM" or "AM" appears on the front panel display.



- 3 Press TUNING MODE (AUTO/MAN'L MONO) so that the "AUTO" indicator lights up on the front panel display.



If the colon (:) appears on the front panel display, press PRESET/TUNING (EDIT) to turn it off.

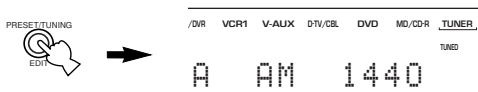

- 4 Press PRESET/TUNING $\triangleleft/\triangleright$ once to begin automatic tuning.

Press \triangleright to tune in to a higher frequency, or press \triangleleft to tune in to a lower frequency.

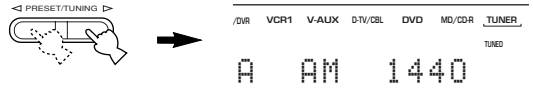

When tuned in to a station, the "TUNED" indicator lights up and the frequency of the received station is shown on the front panel display.



- Use the manual tuning method if the tuning search does not stop at the desired station because the signal is weak.

Manual tuning

If the signal from the station you want to select is weak, you must tune in to it manually.

- 1 Select TUNER and the reception band following steps 1 and 2 described in "Automatic tuning" at left.

- 2 Press TUNING MODE (AUTO/MAN'L MONO) so that the "AUTO" indicator goes off from the front panel display.



If the colon (:) appears on the front panel display, press PRESET/TUNING (EDIT) to turn it off.

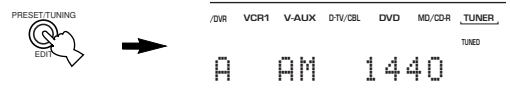

- 3 Press PRESET/TUNING $\triangleleft/\triangleright$ to tune in to the desired station manually.

Hold down the button to continue the tuning search.



Note

- Manually tuning in to an FM station will automatically change the reception mode to monaural to increase the signal quality.

Presetting stations

Automatically presetting stations (for FM stations)

You can use the automatic preset tuning feature to store FM stations. This function enables this unit to automatically tune in to FM stations with strong signals, and to store up to 40 (8 stations x 5 groups) of those stations in order. This feature enables you to easily tune in to any preset station by selecting the preset station number (see page 37).

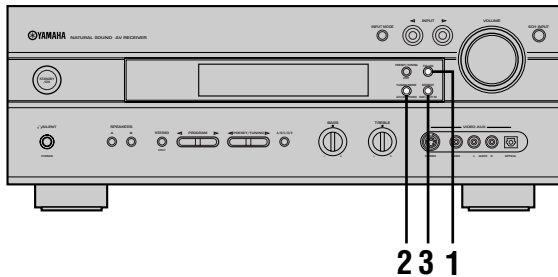

1 Press FM/AM to select the FM band.



2 Press TUNING MODE (AUTO/MAN'L MONO) so that the "AUTO" indicator lights up on the front panel display.



3 Press and hold MEMORY (MAN'L/AUTO FM) for more than 3 seconds.

The preset number and the "MEMORY" and "AUTO" indicators flash. Then, after about 5 seconds, automatic preset tuning begins from the frequency currently displayed toward the higher frequencies.

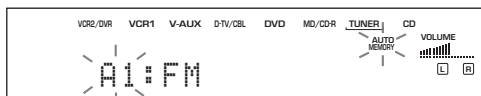

When automatic preset tuning is completed, the front panel display shows the frequency of the last preset station.

Notes

- Any stored station data existing under a preset number is cleared when you store a new station under that preset number.
- When a station data is stored under a preset number, the frequency and reception band are also stored.
- You can manually replace a preset station with another FM or AM station by simply following the procedure in the section "Manually presetting stations" on page 36.
- If the number of the received stations does not reach E8, automatic preset tuning has automatically stopped after searching all stations.
- Only FM stations with sufficient signal strength are stored automatically by automatic preset tuning. If the station you want to store is weak in signal strength, tune in to it manually in the monaural mode, and store it by following the procedure in "Manually presetting stations" on page 36.

Automatic preset tuning options

You can select the preset number from which this unit will store FM stations and/or begin tuning toward lower frequencies. After pressing MEMORY in step 3:

- Press A/B/C/D/E and PRESET/TUNING </> to select the preset number under which the first station will be stored. Automatic preset tuning will stop when stations have all been stored up to E8.
- Press PRESET/TUNING (EDIT) to turn off the colon (:) and then press PRESET/TUNING </> to begin tuning toward lower frequencies.

Memory back-up

The memory back-up circuit prevents the stored data from being lost even if this unit is set in the standby mode, the power cord is disconnected from the AC outlet, or the power supply is temporarily cut due to power failure. However, if the power is cut for more than one week, the preset stations may be cleared. If so, store the stations again.

Manually presetting stations

You can also store up to 40 stations (8 stations x 5 groups) manually.

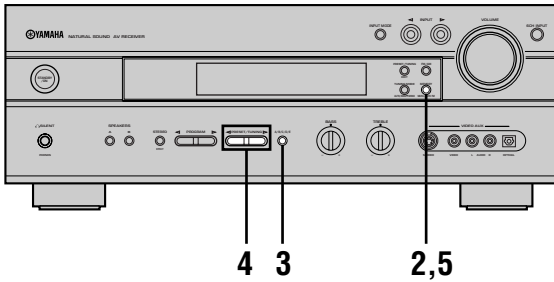

1 Tune in to a station.

See page 34 for tuning instructions.



When tuned in to a station, the front panel display shows the frequency of received station.

2 Press MEMORY (MAN'L/AUTO FM).

The "MEMORY" indicator flashes for about 5 seconds.

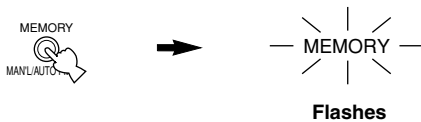

3 Press A/B/C/D/E repeatedly to select a preset station group (A to E) while the "MEMORY" indicator is flashing.

The group letter appears and make sure that the colon (:) appears on the front panel display.



4 Press PRESET/TUNING </> to select a preset station number (1 to 8) while the "MEMORY" indicator is flashing.

Press > to select a higher preset station number. Press < to select a lower preset station number.

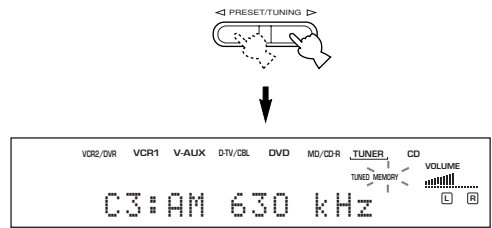

5 Press MEMORY (MAN'L/AUTO FM) on the front panel while the "MEMORY" indicator is flashing.

The station band and frequency appear on the front panel display with the preset group and number you have selected.

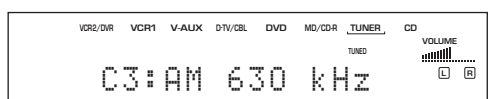

Shows the displayed station has been stored as C3.

6 Repeat steps 1 to 5 to store other stations.

Notes

- Any stored station data existing under a preset number is cleared when you store a new station under that preset number.
- The reception mode (stereo or monaural) is stored along with the station frequency.

Tuning in to a preset station

You can tune any desired station simply by selecting the preset station number under which it was stored.

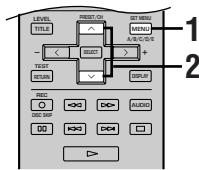
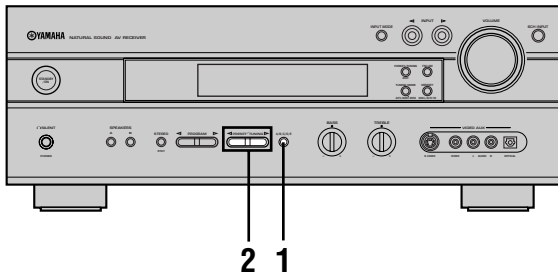

- 1 Press A/B/C/D/E (A/B/C/D/E on the remote control) to select the preset station group. The preset group letter appears on the front panel display and changes each time you press A/B/C/D/E.



Front panel

or



Remote control

- 2 Press PRESET/TUNING </> (PRESET ^ / ∨ on the remote control) to select a preset station number (1 to 8). The preset group and number appear on the front panel display along with the station band, frequency and the “TUNED” indicator lights up.

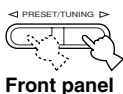

Front panel

or

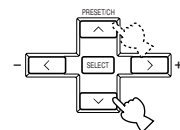

Remote control

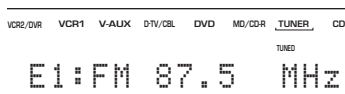

Exchanging preset stations

You can exchange the assignment of two preset stations. The example below describes the procedure for exchanging preset station “E1” with “A5”.

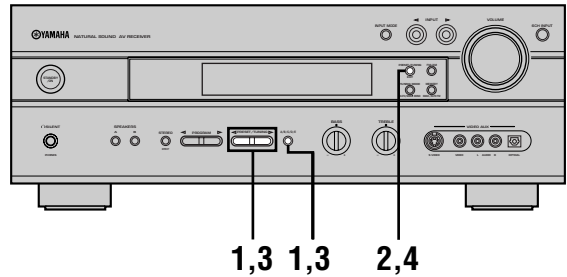

- 1 Tune in to preset station “E1” by using the A/B/C/D/E and PRESET/TUNING </>. See “Tuning in to a preset station” at left.
- 2 Press and hold PRESET/TUNING (EDIT) for more than 3 seconds. “E1” and the “MEMORY” indicator flash on the front panel display.



- 3 Tune in to preset station “A5” by using the A/B/C/D/E and PRESET/TUNING </>. “A5” and the “MEMORY” indicator flash on the front panel display.

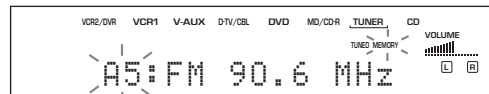

- 4 Press PRESET/TUNING (EDIT) again. The stations stored at the two preset assignments are exchanged.



Shows the exchange of stations has been completed.

SLEEP TIMER

Use this feature to automatically set this unit in the standby mode after the amount of time you have set. The sleep timer is useful when you are going to sleep while this unit is playing or recording a source. The sleep timer also automatically turns off the external component(s) connected to AC OUTLET(S).

The sleep timer can only be set with the remote control.



- By connecting a commercially available timer to this unit, you can also set a wake-up timer. Refer to the operation instructions of the timer.

Setting the sleep timer

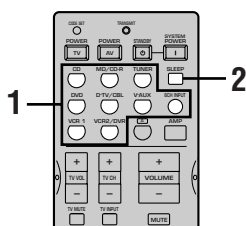

1 Select a source and start playback on the source component.

2 Press SLEEP repeatedly to set the amount of time.

Each time you press SLEEP, the front panel display changes as shown below.

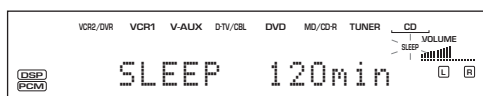
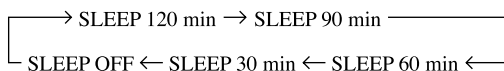

3 The “SLEEP” indicator lights up on the front panel display soon after the sleep timer has been set.

The display then returns to the previous indication.

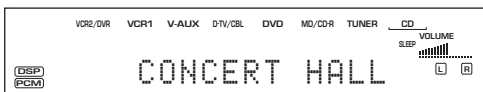

Canceling the sleep timer

Press SLEEP repeatedly until “SLEEP OFF” appears on the front panel display.

After a few seconds, “SLEEP OFF” disappears, the “SLEEP” indicator goes off and the display returns to the previous indication.

SLEEP



SLEEP OFF



- The sleep timer setting can also be canceled by setting this unit in the standby mode by using STANDBY on the remote control (or STANDBY/ON on the front panel) or by disconnecting the AC power cord from the AC outlet.

RECORDING

Recording adjustments and other operations are performed from the recording components. Refer to the operation instructions for these components.

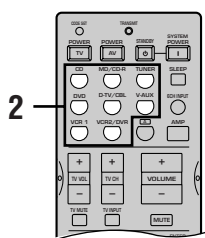
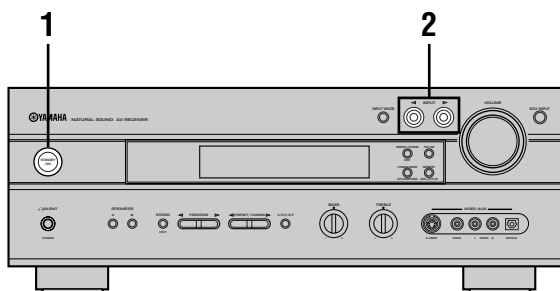

1 Turn on the power of this unit and all connected component.

2 Select the source component you want to record from.

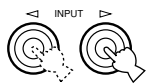

Front panel

or

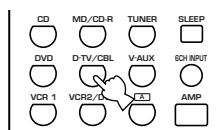

Remote control

3 Start playback (or select a broadcast station) on the source component.

4 Start recording on the recording component.

Notes

- Do a test recording before you start an actual recording.
- When this unit is set in the standby mode, you cannot record between the components connected to this unit.
- The setting of BASS, TREBLE, VOLUME, “5 L/R BALANCE” on the SET MENU and DSP programs does not effect the recorded material.
- A source connected to the 6CH INPUT jacks on this unit cannot be recorded.
- A given input source is not output to the same OUT (REC) channel. (For example, the signal input from VCR 1 IN is not output to VCR 1 OUT.)
- Check the copyright laws in your country to record from records, CDs, radio, etc. Recording of copyrighted material may infringe copyright laws.

If you playback a video source that uses scrambled or encoded signals to prevent it from being dubbed, the picture itself may be disturbed due to those signals.

Special considerations when recording DTS software

The DTS signal is a digital bitstream. Attempting to digitally record the DTS bitstream will result in noise being recorded. Therefore, if you want to use this unit to record sources that have DTS signals recorded on them, the following considerations and adjustments need to be made.

For LDs, DVDs and CDs encoded with DTS, when your player is compatible with the DTS format, follow its operation instruction to make a setting so that the analog signal will be output from the player.

Timer playback/recording

This unit can perform playback or recording with an external timer (not supplied). Refer to the operating instructions for the component and the timer to be used.

Notes

- Stored data, such as input source, will be reflected when playback or recording with the timer.
- If you do not want any sound output when recording with a timer, turn the volume down.

Memory back-up

The memory back-up circuit prevents the stored data (input source, volume level, set menu settings and so on) from being lost even if this unit is disconnected from the AC outlet. However, if the timer is turned off for more than one week, the stored data will be lost.

SET MENU

The SET MENU consists of 10 items including the speaker mode setting. Choose the appropriate item and adjust or select the values as necessary.



- You can adjust the items on the SET MENU while playing a source.

Items	Initial settings
1 SPEAKER SET	
A CENTER	LRG (large)
B MAIN	LARGE
C REAR LR	LRG (large)
D REAR CT	LRG (large)
E BASS	BOTH
F MAIN Lv	Nrm (Normal)
2 LFE LEVEL SP/HP	0 dB
3 SP DLY TIME	
CENTER	0 ms
REAR CNTR	3 ms
4 D. RANGE SP/HP	MAX
5 L/R BALANCE	0 dB for L/R
6 HP TONE CTRL BASS/TRBL	0 dB
7 I/O ASSIGN	
A (component video input)	[A] DVD [B] D-TV/CBL
B (optical output)	(1) MD/CDR
C (optical input)	(2) MD/CDR (3) DVD (4) D-TV/CBL
D (coaxial input)	(5) CD
8 INPUT MODE	AUTO
9 DISPLAY SET DIMMER	0
10 MEM. GUARD	OFF

- In the descriptions for each item from the following page, the default setting is indicated in bold.

Adjusting the items on the SET MENU

Adjustment should be made with the remote control.

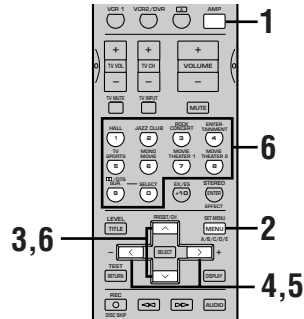

Note

- Some items require extra steps.

1 Press AMP.



2 Press SET MENU to enter the SET MENU.



3 Press ^/v repeatedly to select the item you want to adjust (1 to 10).

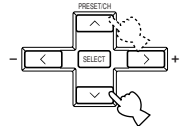

- By pressing SET MENU repeatedly, you can select items in the same order as when pressing v.

4 Press </> once to enter the setup mode of the selected item.

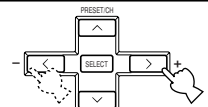

The last setting you adjusted appears on the front panel display.

Depending on the item, press ^/v to select a sub item.

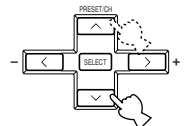

- 5** Press \langle / \rangle repeatedly to change the setting of the item.

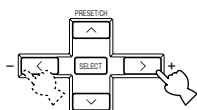

- 6** Press $\wedge \vee$ repeatedly until the menu disappears or simply press one of the DSP program group buttons to exit SET MENU.

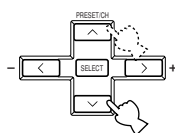

or

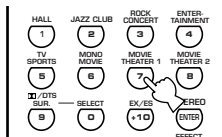

Memory back-up

The memory back-up circuit prevents the stored data from being lost even if this unit is in the standby mode. However, if the power cord is disconnected from the AC outlet, or the power supply is cut for more than one week, the stored data will be lost. If so, adjust the items again.

1 SPEAKER SET (speaker mode settings)

Use this feature to select suitable output modes for your speaker configuration.

Notes

- When 96-kHz sampling digital signals are input to this unit, some items are not affected.
- When 6CH INPUT is selected as the input source, level adjustments in items 1A through 1E are not affected.

1A CENTER (center speaker mode)

By adding a center speaker to your speaker configuration, this unit can provide better dialog localization for several listeners and superior synchronization of sound and images.

Choices: **LRG** (large), **SML** (small), **NON** (none)

LRG

Select this if you have a large center speaker. The entire range of the center channel signal is directed to the center speaker.

SML

Select this if you have a small center speaker. The low-frequency signals (90 Hz and below) of the center channel are directed to the speakers selected with "1E BASS".

NON

Select this if you do not have a center speaker. All of the center channel signal are directed to the main left and right speakers.

■ 1B MAIN (main speaker mode)

Choices: **LARGE**, **SMALL**

LARGE

Select this if you have large main speakers. The entire range of the main left and right channel signal is directed to the main left and right speakers.

SMALL

Select this if you have small main speakers. The low-frequency signals (90 Hz and below) of the main channel are directed to the speakers selected with "1E BASS".

■ 1C REAR LR (rear speaker mode)

Choices: **LRG** (large), **SML** (small), **NON** (none)

LRG

Select this if you have large rear left and right speakers or if a rear subwoofer is connected to the rear speakers. The entire range of the rear channel signal is directed to the rear left and right speakers.

SML

Select this if you have small rear left and right speakers. The low-frequency signals (90 Hz and below) of the rear channel are directed to the speakers selected with "1E BASS".

NON

Select this if you do not have rear speakers.



- This unit is set in the virtual CINEMA DSP mode when you select NON for "1C REAR LR". In this case, the rear center speaker will automatically be set to "NON" and the "1D REAR CT" item will be skipped.

■ 1D REAR CT (rear center speaker mode)

By adding a rear center speaker to your speaker configuration, this unit can provide more realistic front-to-back and transitions.

Choices: **LRG** (large), **SML** (small), **NON** (none)

LRG

Select this if you have a large rear center speaker. The entire range of the rear center channel signal is directed to the rear center speaker.

SML

Select this if you have a small rear center speaker. The low-frequency signals (90 Hz and below) of the rear center channel are directed to the speakers selected with "1E BASS".

NON

Select this if you do not have a rear center speaker. All of the rear center channel signal are directed to the rear left and right speakers.

■ 1E BASS (LFE/bass out mode)

LFE signals carry low-frequency effects when this unit decodes a Dolby Digital or DTS signal. Low-frequency signals are defined as 90 Hz and below. The Low-frequency signals can be directed to both main left and right speakers, and the subwoofer (subwoofer can be used for both stereo reproduction and the DSP program).

Choices: **SWFR** (subwoofer), **MAIN**, **BOTH**

SWFR

Select this if you use a subwoofer. The LFE signals are directed to the subwoofer.

MAIN

Select this if you do not use a subwoofer. The LFE signals are directed to the main speakers.

BOTH

The LFE signals are directed to the subwoofer. Low-frequency signals designated to the main channels in accordance with other speaker mode settings are directed to both main speakers and a subwoofer.

Note

- When you select MAIN for "1E BASS", the low-frequency signals (90 Hz and below) of the main channel are directed to the main speakers even if you select SMALL for the main speaker mode.

1F MAIN Lv (main level mode)

Change this setting if you cannot match the output level of the center, rear (L/R), and rear center speakers with the main speakers because of unusually high-efficiency performance from the main speakers.

Choices: **Nrm** (Normal), -10 dB

Nrm

Select this if you can match the output level of your effect speakers with that of your main speakers when using the test tone.

-10 dB

Select this if you cannot match the output level of your effect speakers with that of your main speakers when using the test tone.

2 LFE LEVEL

Use this feature to adjust the output level of the LFE (low-frequency effect) channel when playing back a Dolby Digital or DTS signal. The LFE signal carries the low-frequency special effect sound which is only added to certain scenes.

Control range:

SPEAKER -20 to 0 dB

HEADPHONE -20 to 0 dB

Initial setting: 0 dB

1 Press ∇/\wedge to select the item to be adjusted.

2 Press \leftarrow to adjust the LFE level.

Note

- Adjust the LFE level according to the capacity of your subwoofer or headphones.

3 SP DLY TIME (speaker delay time)

Use this feature to adjust the delay of the center and the rear center channel sounds. This feature works when there is sound output from the center speakers, with a source like Dolby Digital or DTS, etc. Ideally, the center speaker and the rear center speaker should be the same distance from the main listening position as the left and right speakers. However, in most home situations, the center speaker or the rear center speaker are placed in line with the main speakers or the rear speakers. By delaying the sound from the center speaker and the rear center speaker, the apparent distance from the center speaker and the rear center speaker to the main listening position can be adjusted to make it seem the same as the distance between the main left and right speaker, and the rear left and right speakers to the listening position. Adjusting the delay time for the center speaker is especially important for giving depth to the dialogue.

Control range:

CENTER 0 to 5 ms

REAR CNTR (center) 0 to 30 ms

Initial setting:

CENTER 0 ms

REAR CNTR (center) 3 ms

Press \leftarrow/\rightarrow to increase or decrease the delay of the center and the rear center channel sounds.

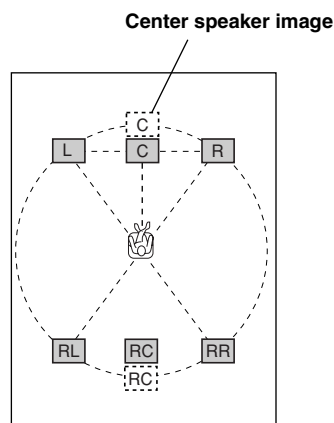

- Increasing the delay by 1 ms simulates moving the speakers about 30 cm (one foot) farther away from the listening position.

4 D. RANGE (dynamic range)

Use this feature to adjust the dynamic range. This setting is effective only when this unit is decoding Dolby Digital signals.

Choices: **MAX**, STD (standard), MIN (minimum)

MAX

Select the "MAX" for feature films.

STD

Select the "STD" for general use.

MIN

Select the "MIN" for listening to sources at low volume levels.

5 L/R BALANCE (balance of the main left and right speakers)

Use this feature to adjust the balance of the output level from the main left and right speakers.

Control range: 20 steps for L/R

Initial setting: 0 dB for L/R

■ Press > to decrease the output level for the main left speaker. Press < for the main right speaker.

6 HP TONE CTRL (headphone tone control)

Use this feature to adjust the level of the bass and treble when you use your headphones.

Control range (dB):

BASS -6 to +3

TRBL (treble) .. -6 to +3

Initial setting:

BASS 0 dB

TRBL 0 dB

7 I/O ASSIGN (input/output assignment)

It is possible to assign jacks according to the component to be used if this unit's COMPONENT VIDEO input jack or DIGITAL INPUT/OUTPUT jack settings (component names for jacks) differ from that component. This makes it possible to change the jack assignment and effectively connect more components.

Once you assign, you can select that component with INPUT </> (or the input selector buttons on the remote control).

■ 7A CMPNT-V INPUT for COMPONENT VIDEO INPUT jacks [A] and [B]

Choices: [A] DVD, V-AUX, VCR 2/DVR, VCR 1, D-TV/CBL
[B] DVD, V-AUX, VCR 2/DVR, VCR 1, D-TV/CBL

■ 7B OPTICAL OUT for OPTICAL OUTPUT jack (1)

Choices: (1) MD/CD-R, CD, V-AUX, VCR 2/DVR, VCR 1, D-TV/CBL, DVD

■ 7C OPTICAL IN for OPTICAL INPUT jacks (2) to (4)

Choices: (2) MD/CD-R, CD, VCR 2/DVR, VCR 1, D-TV/CBL, DVD
(3) MD/CD-R, CD, VCR 2/DVR, VCR 1, D-TV/CBL, DVD
(4) MD/CD-R, CD, VCR 2/DVR, VCR 1, D-TV/CBL, DVD

■ 7D COAXIAL IN for COAXIAL INPUT jack (5)

Choices: (5) MD/CD-R, CD, V-AUX, VCR 2/DVR, VCR 1, D-TV/CBL, DVD

Notes

- You cannot select an item more than once for the same type of jack.
- When you connect a component to both the COAXIAL and OPTICAL jacks, priority is given to the input signals from the COAXIAL jack.

8 INPUT MODE (initial input mode)

Use this feature to designate the input mode for sources connected to the DIGITAL INPUT jacks when you turn on this unit (see page 25 for details about the input mode).

Choices: **AUTO**, **LAST**

AUTO

Select this to allow this unit to automatically detect the type of input signal and select the appropriate input mode.

LAST

Select this to set this unit to automatically select the last input mode used for the respective source.

9 DISPLAY SET

■ DIMMER

You can adjust the brightness of the front panel display.

Control range: -4 to 0

Initial setting: 0

10 MEM. GUARD (memory guard)

Use this feature to prevent accidental changes to settings on this unit.

Choices: **ON**, **OFF**

Select **ON** to protect the following features:

- All SET MENU items
- Center, rear speakers, rear center, and subwoofer levels
- DSP program parameters

Notes

- When this item is set to **ON**, you cannot use the test tone.
- When this item is set to **ON**, you cannot select any other SET MENU items.

REMOTE CONTROL FEATURES

In addition to controlling this unit, the remote control can operate other A/V components made by YAMAHA and other manufacturers. To control other components, you must set up the remote control with the manufacturer codes.

Control area

■ Controlling this unit

The shaded areas below can be used to control this unit when the AMP mode is selected. Press AMP to select the AMP mode.

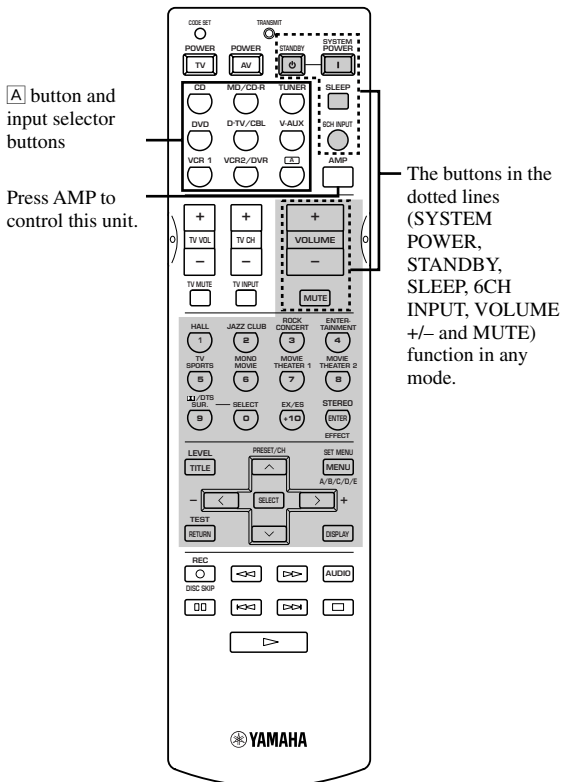

■ Controlling other component

The shaded areas below can be used to control other components. Each button has a different function depending on the selected components. Select the component to be controlled by pressing an input selector button.

The buttons in the dotted lines (SYSTEM POWER, STANDBY, SLEEP, 6CH INPUT, VOLUME +/- and MUTE) function in any mode.

* [A] button is to operate the other components that are not connected to this unit.
Factory setting:
[A]...VCR

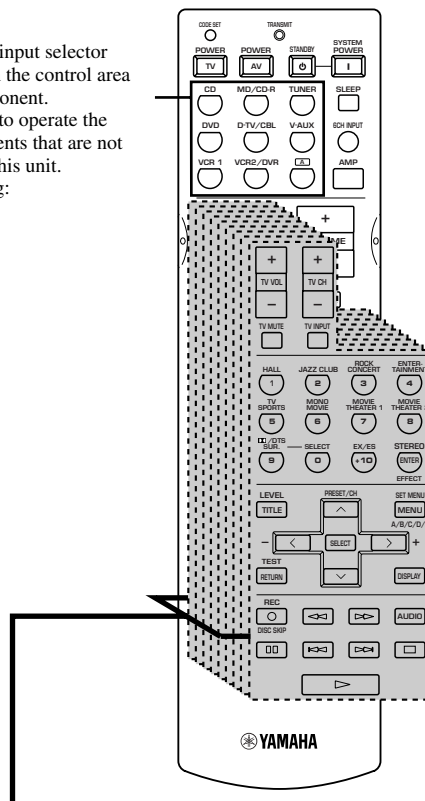

Component control area

You can control up to 9 different components. You can set up manufacturer code and program other remote control functions for each component (see page 48).

Setting the manufacturer code

You can control other components by setting a manufacturer code. Codes can be set for each of the 9 component controls.

The following table shows factory-set component (Library: component category) and the manufacturer code for each component control.

Component control (buttons)	Component category (Library)	Manufacturer	Code
CD	CD	YAMAHA	0005
MD/CD-R	MD	YAMAHA	0024
TUNER	TUNER	YAMAHA	0003
DVD	DVD	YAMAHA	0098
D-TV/CBL	-	-	-
V-AUX	-	-	-
VCR 1	-	-	-
VCR 2/DVR	-	-	-
A	-	-	-

1 Press an input selector button or **A** to select the component you want to set up.

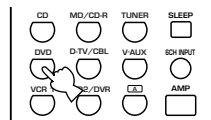

2 Press CODE SET using a ballpoint pen or similar object.

The TRANSMIT indicator flashes twice.



3 Press the numeric buttons to enter the four digit manufacturer's code for the component to be used.

Refer to "LIST OF MANUFACTURER'S CODES" at the end of this manual.

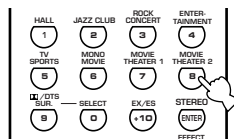

The TRANSMIT indicator flashes twice.

Notes

- If the manufacturer of your component has more than one code, try each of them until you find the correct one.
- If you wait for more than 30 seconds during step 3, the setup process is canceled. If this happens, start over from step 2.

Clearing setup manufacturer codes

Clearing setup manufacturer code for the component control

1 Press an input selector button or **A** to select the component control for which you want to clear the manufacturer code.

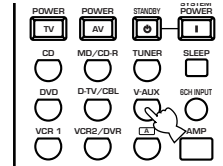

2 Press CODE SET by using a ballpoint pen or similar object.

The TRANSMIT indicator flashes twice.



Note

- If you do not press any button within 30 seconds after step 2, the clearing process is canceled. If this happens, start over from step 1.

3 Enter the code number "0000".

The TRANSMIT indicator flashes twice, and the manufacturer code for the selected component is cleared.



- You can clear all setup manufacturer codes at once by entering the code number "9990".

Controlling other components

You can operate other components when you have set the manufacturer code for your component. Note, however, that some buttons may not operate your component. Once you select an input source, the remote control switches to the mode for operating the component.

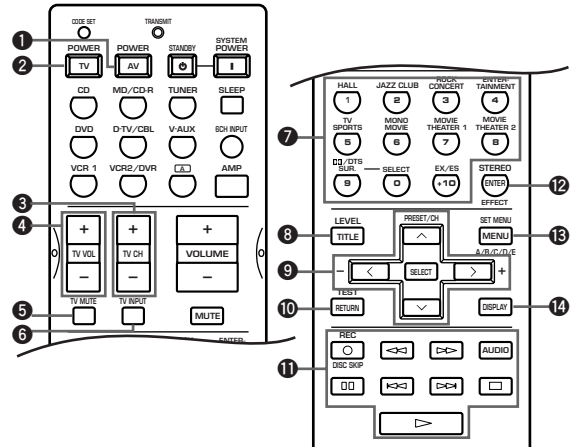

	DVD player	VCR	TV, digital/cable TV	CD player	CD/MD recorder	Tuner
1 AV POWER	*1Power	*1Power	*3VCR power	*1Power	*1Power	*1Power
2 TV POWER	*2TV power	*2TV power	*2TV power	*2TV power	*2TV power	*2TV power
3 TV CH + TV CH -	*2TV channel up *2TV channel down	*2TV channel up *2TV channel down	TV channel up TV channel down	*2TV channel up *2TV channel down	*2TV channel up *2TV channel down	*2TV channel up *2TV channel down
4 TV VOL + TV VOL -	*2TV volume up *2TV volume down	*2TV volume up *2TV volume down	TV volume up TV volume down	*2TV volume up *2TV volume down	*2TV volume up *2TV volume down	*2TV volume up *2TV volume down
5 TV MUTE	*2TV mute	*2TV mute	TV mute	*2TV mute	*2TV mute	*2TV mute
6 TV INPUT	*2TV input	*2TV input	TV input	*2TV input	*2TV input	*2TV input
7 1-9, 0, +10	Numeric buttons	Numeric buttons	Numeric buttons	Numeric buttons	Numeric buttons	Preset stations (1-8)
8 TITLE	Title					
9 PRESET/CH ^ PRESET/CH v PRESET/CH < PRESET/CH > SELECT	Up Down Left Right Select	VCR channel up VCR channel down				Preset up Preset down
10 RETURN	Return					
11 REC/DISC SKIP ▷ ◁◁ ▷▷	Disc skip Play Search backward Search forward	Rec Play Search backward Search forward	*3VCR rec *3VCR play *3VCR search backward *3VCR search forward	Disc skip Play Search backward Search forward	Rec (MD) Play Search backward Search forward	
AUDIO ⏸ ◁◁ ▷▷ □	Audio Pause Skip backward Skip forward Stop	Pause Pause Skip backward Skip forward Stop	*3VCR pause *3VCR pause Skip backward Skip forward Stop	Pause Pause Skip backward Skip forward Stop	Pause Pause Skip backward Skip forward Stop	
12 ENTER	Title/Index	Enter	Enter	Index	Index	
13 MENU	Menu					A/B/C/D/E
14 DISPLAY	Display			Display	Display	

*1 This button functions only when the original remote control of the component has POWER button.

*2 These buttons can operate your TV without switching the input if the manufacturer code is set in D-TV/CBL.

*3 These buttons can operate your VCR without switching the input to VCR if the manufacturer code is set in VCR.

ADJUSTING THE LEVEL OF THE EFFECT SPEAKERS

You can adjust the output level of each effect speaker (center, rear left and right, rear center and subwoofer) while listening to a source.

Adjustment should be made with the remote control.

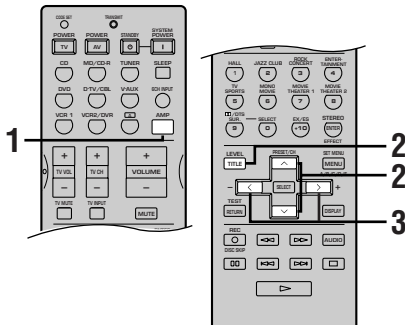

1 Press AMP.



(While playing a source)

2 Press LEVEL repeatedly to select the speaker(s) you want to adjust.

Each time you press LEVEL, the selected speaker changes and appears on the front panel display as follows: center, rear right, rear center, rear left and subwoofer.

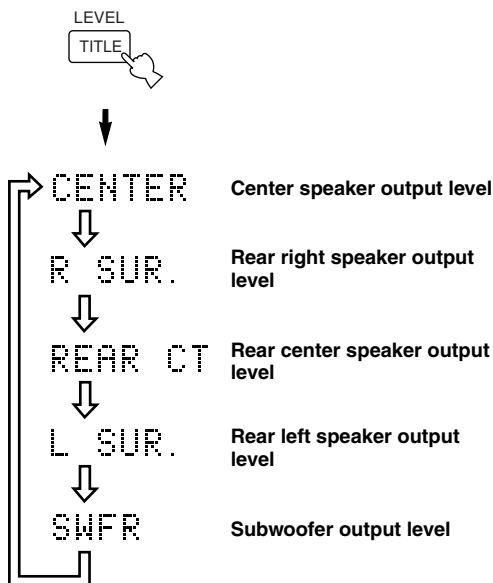

- Once you press LEVEL, you can also select the speaker(s) to be adjusted by pressing \vee / \wedge .

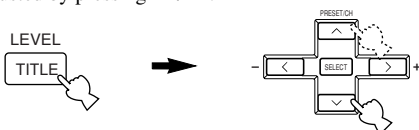

3 Press \langle / \rangle to adjust the speaker output level.

- The control range for the center or rear left and right speakers is from +10 dB to -10 dB.
- The control range for the subwoofer is from 0 dB to -20 dB.

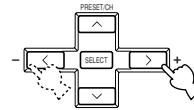

Notes

- When the speaker output modes for "1A CENTER" and "1C REAR LR" are set to NON, and "1E BASS" to MAIN, the output level of those speakers cannot be adjusted because there is no sound coming from these speakers.
- When you adjust the output level with LEVEL, the settings you made with the test tone will be changed.
- We recommend adjusting the speakers by following the steps described in "Using the test tone" on pages 21 and 22.

For 6ch Stereo

You can adjust the volume level for each channel in 6-channel stereo mode.

Control range: 0 to 100%

- CT level** (Center level)
- RL level** (Rear left level)
- RR level** (Rear right level)
- RC level** (Rear center level)

1 Select 6ch Stereo.

2 Press \wedge / \vee repeatedly to select the speaker(s) you want to adjust.

3 Press \langle / \rangle to adjust the speaker output level.

Memory back-up

The memory back-up circuit prevents the stored data from being lost even if this unit is in the standby mode. However, if the power cord is disconnected from the AC outlet, or the power supply is cut for more than one week, the stored data will be lost. If so, set the output level again.

ADJUSTING THE DELAY TIME

You can adjust the time difference between the beginning of the sound from the main speakers and the beginning of the sound effect from the rear speakers. The larger the value, the later the sound effect is generated. The delay time can be individually adjusted to all DSP programs.

The following table shows factory-set delay time.

Program	Preset value (ms)
1. CONCERT HALL	45
2. JAZZ CLUB	30
3. ROCK CONCERT	15
4. DISCO	26
GAME	36
CONCERT VIDEO	21
5. TV SPORTS	10
6. MONO MOVIE	69
7. 70 mm SPECTACLE	23
DGTL SPECTACLE	15
DTS SPECTACLE	15
Spectacle EX/ES	15
70 mm SCI-FI	20
Sci-Fi EX/ES	15
DGTL SCI-FI	15
DTS SCI-FI	15
8. 70 mm ADVENTURE	20
DGTL ADVENTURE	15
DTS ADVENTURE	15
Adventure EX/ES	15
70 mm GENERAL	20
DGTL GENERAL	15
DTS GENERAL	15
General EX/ES	15
9. PRO LOGIC/NORMAL	15
DOLBY DIGITAL/NORMAL	5
DTS DIGITAL SUR./NORMAL	5
Dolby D EX/DTS-ES	5
PRO LOGIC/ENHANCED	20
DOLBY DIGITAL/ENHANCED	5
DTS DIGITAL SUR./ENHANCED	5
Enhanced EX/ES	5
PRO LOGIC II Movie	15
PRO LOGIC II Music	5

Adjustment should be made with the remote control.

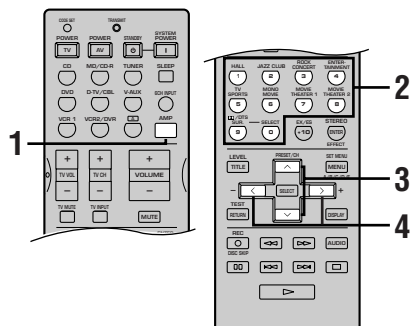

1 Press AMP.



(While playing a source)

2 Select a DSP program you want to adjust the delay time.

3 Press \wedge / \vee so that "DELAY" appears on the front panel display.

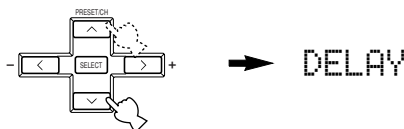

4 Press \langle / \rangle to adjust the delay time.

Notes

- Adding too much delay will cause an unnatural effect with some sources.
- The sound is momentarily interrupted while adjusting the delay time.

Memory back-up

The memory back-up circuit prevents the stored data from being lost even if this unit is in the standby mode. However, if the power cord is disconnected from the AC outlet, or the power supply is cut for more than one week, the stored data will be lost. If so, adjust the delay time again.

ADJUSTING THE PARAMETER SETTINGS FOR PRO LOGIC II MUSIC

Changing parameter settings

You can adjust the values of PRO LOGIC II Music parameters so the sound fields are recreated accurately in your listening room.

Adjustments should be made with the remote control.

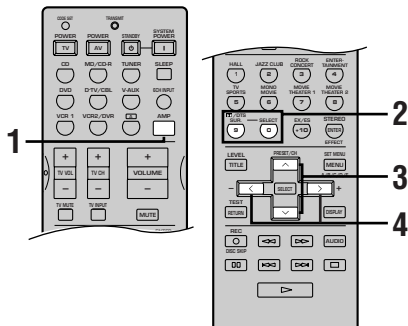

1 Press AMP.



2 Select PRO LOGIC II Music.

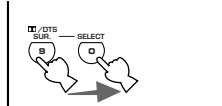

3 Press ^ / v to select the parameter.

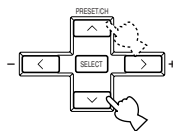

4 Press < / > to change the parameter value.

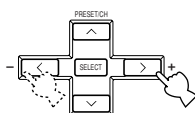

5 Repeat steps 3 and 4 above as necessary to change other parameters.

Note

- You cannot change parameter values when "10 MEM. GUARD" on the SET MENU is set to ON.

Memory back-up

The memory back-up circuit prevents the stored data from being lost even if this unit is set in the standby mode, the power cord is disconnected from the AC outlet, or the power supply is temporarily cut due to power failure. However, if the power is cut for more than one week, the parameter value you edited will return to the factory setting. If so, edit the parameter value again.

PRO LOGIC II Music parameter descriptions

■ PANORAMA

Function: Turning the function on extends the front stereo image to include the surround speakers for wraparound effect.

Choices: OFF/ON, initial setting is OFF.

■ DIMENSION

Function: Gradually adjusts the soundfield either towards the front or towards the rear.

Control range: -3 (towards the rear) to +3 (towards the front), initial setting is STD (standard).

■ CT WIDTH (Center width)

Function: Adjusts the center image from all three front speakers to varying degrees. The larger the value, adjusts the center image towards the main left and right speakers.

Control range: 0 (center channel sound is output only from center speaker) to 7 (center channel sound is output only from main left and right speakers), initial setting is 3.

TROUBLESHOOTING

Refer to the chart below when this unit does not function properly. If the problem you are experiencing is not listed below or if the instruction below does not help, set this unit to the standby mode, disconnect the power cord, and contact the nearest authorized YAMAHA dealer or service center.

■ General

Problem	Cause	Remedy	Refer to page
This unit fails to turn on when STANDBY/ON (or SYSTEM POWER) is pressed, or enters in the standby mode soon after the power has been turned on.	The power cord is not connected or the plug is not completely inserted.	Firmly connect the power cord.	—
	The IMPEDANCE SELECTOR switch on the rear panel is not fully set to either the left or right position.	Set the switch fully to the left or right position when this unit is in the standby mode.	12
	The protection circuitry has been activated.	Make sure all speaker wire connections on this unit and on all speakers are secure and that the wire for each connection does not touch anything other than its respective connection.	10, 11
	This unit has been exposed to a strong external electric shock (such as lightning and strong static electricity).	Set this unit in the standby mode, disconnect the power cord, plug it back in after 30 seconds, then start operating.	—
No sound.	Incorrect input or output cable connections.	Connect the cables properly. If the problem persists, the cables may be defective.	10 – 16
	An appropriate input source has not been selected.	Select an appropriate input source with INPUT </> or 6CH INPUT (or the input selector buttons).	23
	The speaker connections are not secure.	Secure the connections.	10, 11
	The main speakers to be used have not been selected properly.	Select the main speakers with SPEAKERS A and/or B.	23
	The volume is turned down.	Turn up the volume.	24
	The sound is muted.	Press MUTE or any operation buttons of this unit to cancel a mute and adjust the volume.	—
	Digital signals which this unit cannot reproduce are being input to this unit by playing a CD-ROM, etc.	Play a source whose signals this unit can reproduce.	—
The picture does not appear.	The output and input for the picture are connected to different types of video jacks.	Make connections using the same type of video jacks (S VIDEO, VIDEO (composite), or COMPONENT VIDEO) for both the input and output.	14, 15

Problem	Cause	Remedy	Refer to page
The sound suddenly goes off.	The protection circuit has been activated because of a short circuit, etc.	Check the IMPEDANCE SELECTOR switch is set to the appropriate position and then turn this unit back on.	12
		Check the speaker wires are not touching each other and then turn this unit back on.	—
	The sleep timer has functioned.	Turn on the power, and play the source again.	—
	The sound is muted.	Press MUTE or any operation buttons of this unit to cancel a mute and adjust the volume.	—
Only the speaker on one side can be heard.	Incorrect cable connections.	Connect the cables properly. If the problem persists, the cables may be defective.	10, 11
	Incorrect setting of “5 L/R BALANCE” on the SET MENU.	Adjust it to the appropriate position.	44
No sound from the effect speakers.	The sound effect is off.	Press STEREO/EFFECT to turn it on.	28
	A Dolby Surround, Dolby Digital or DTS decoding DSP program is being used with material not encoded with Dolby Surround, Dolby Digital or DTS.	Select another DSP program.	26 – 33
	A 96-kHz sampling digital signal is being input to this unit.		—
No sound from the center speaker.	The output level of the center speaker is set to minimum.	Raise the level of the center speaker.	49
	“1A CENTER” on the SET MENU is set to NON.	Select the appropriate mode for your center speaker.	41
	One of the Hi-Fi DSP programs (1 to 4) has been selected (except for 6ch Stereo).	Select another DSP program.	26 – 33
	The source encoded with a Dolby Digital or DTS signal does not have a center channel signal.		—
No sound from the rear speakers.	The output level of the rear speakers is set to minimum.	Raise the output level of the rear speakers.	49
	A monaural source is being played with program 9.	Select another DSP program.	26 – 33
No sound from the subwoofer.	“1E BASS” on the SET MENU is set to MAIN when a Dolby Digital or DTS signal is being played.	Select SWFR or BOTH.	42
	“1E BASS” on the SET MENU is set to SWFR or MAIN when a 2-channel source is being played.	Select BOTH.	42
	The source does not contain low bass signals (90 Hz and below).		—
Poor bass reproduction.	“1E BASS” on the SET MENU is set to SWFR or BOTH and your system does not include a subwoofer.	Select MAIN.	42
	The speaker mode settings (main, center, rear, or rear center) on the SET MENU does not match your speaker configuration.	Select the appropriate position for each speaker based on the size of the speakers in your configuration.	41 – 43

Problem	Cause	Remedy	Refer to page
No sound from the rear center speaker.	“1C REAR LR” or “1D REAR CT” on the SET MENU is set to NON.	Select LRG or SML.	42
	The Dolby Digital EX decoder or the DTS-ES compatible decoder is not on.	Press the EX/ES button on the remote control to turn it on.	28
A “humming” sound can be heard.	Incorrect cable connections.	Firmly connect the audio plugs. If the problem persists, the cables may be defective.	10 – 16
The volume level cannot be increased, or the sound is distorted.	The component connected to the OUT (REC) jacks of this unit is turned off.	Turn on the power to the component.	—
The sound effect cannot be recorded.	It is not possible to record the sound effect by a recording component.		—
A source cannot be recorded by a digital recording component connected to the DIGITAL OUTPUT jack of this unit.	A source component is not connected to the DIGITAL INPUT jacks of this unit.	Connect the source component to the DIGITAL INPUT jacks of this unit.	—
The sound field parameters and some other settings on this unit cannot be changed.	“10 MEM. GUARD” in the SET MENU is set to ON.	Set “10 MEM. GUARD” in the SET MENU to OFF.	—
This unit does not operate properly.	The internal microcomputer has been frozen by an external electric shock (such as lightning or excessive static electricity) or by a power supply with low voltage.	Disconnect the AC power cord from the outlet and then plug it in again after about 30 seconds.	—
“CHECK SP WIRES” appears on the front panel display.	Speaker cables are short circuited.	Make sure all speaker cables are connected correctly.	—
There is noise interference from digital or high-frequency equipment, or this unit.	This unit is too close to the digital or high-frequency equipment.	Move this unit further away from such equipment.	—
This unit suddenly turns into the standby mode.	The internal temperature becomes too high and the overheat protection circuitry has been activated.	Wait until this unit cools down and then turn it back on.	—

■ Tuner

Problem		Cause	Remedy	Refer to page
FM	FM stereo reception is noisy.	The characteristics of FM stereo broadcasts may cause this problem when the transmitter is too far away or the antenna input is poor.	Check the antenna connections. Try using a high-quality directional FM antenna.	17
			Use the manual tuning method.	34
	There is distortion, and clear reception cannot be obtained even with a good FM antenna.	There is multipath interference.	Adjust the antenna position to eliminate multipath interference.	—
	The desired station cannot be tuned in with the automatic tuning method.	The station is too weak.	Use a high-quality directional FM antenna.	17
Use the manual tuning method.			34	
Previously preset stations can no longer be tuned in.	This unit has been disconnected for a long period.	Re-store the stations.	35, 36	
AM	The desired station cannot be tuned in with the automatic tuning method.	The signal is weak or the antenna connections are loose.	Tighten the AM loop antenna connections and orient it for best reception.	17
			Use the manual tuning method.	34
	There are continuous crackling and hissing noises.	Noises result from lightning, fluorescent lamps, motors, thermostats and other electrical equipment.	Use an outdoor antenna and a ground wire. This will help somewhat, but it is difficult to eliminate all noise.	17
	There are buzzing and whining noises (especially in the evening).	A TV set is being used nearby.	Move this unit away from the TV.	—

■ Remote control

Problem	Cause	Remedy	Refer to page
The remote control does not work nor function properly.	Wrong distance or angle.	The remote control will function within a maximum range of 6 m (20 feet) and no more than 30 degrees off-axis from the front panel.	7
	Direct sunlight or lighting (from an inverter type of fluorescent lamp, etc.) is striking the remote control sensor of this unit.	Reposition this unit.	—
	The batteries are weak.	Replace all batteries with new ones.	3
	The manufacture code has not correctly set.	Set the code correctly.	47
		Try setting another code of the same manufacturer.	—
Even if the manufacturer code is correctly set, there are some models that do not respond to the remote control.			—

GLOSSARY

■ Dolby Surround

Dolby Surround uses a 4 channel analog recording system to reproduce realistic and dynamic sound effects: 2 main left and right channels (stereo), a center channel for dialog (monaural), and a rear channel for special sound effects (monaural). The rear channel reproduces sound within a narrow frequency range.

Dolby Surround is widely used with nearly all video tapes and laser discs, and in many TV and cable broadcasts as well. The Dolby Pro Logic decoder built into this unit employs a digital signal processing system that automatically stabilizes the volume on each channel to enhance moving sound effects and directionality.

■ Dolby Digital

Dolby Digital is a digital surround sound system that gives you completely independent multi-channel audio. With 3 front channels (left, center, and right), and 2 rear stereo channels, Dolby Digital provides 5 full-range audio channels. With an additional channel especially for bass effects, called LFE (low frequency effect), the system has a total of 5.1 channels (LFE is counted as 0.1 channel). By using 2-channel stereo for the rear speakers, more accurate moving sound effects and surround sound environment are possible than with Dolby Surround. The wide dynamic range (from maximum to minimum volume) reproduced by the 5 full-range channels and the precise sound orientation generated using digital sound processing provide listeners with previously unheard of excitement and realism.

With this unit, any sound environment from monaural up to a 5.1-channel configuration can be freely selected for your enjoyment.

Dolby Digital EX creates 6 full-bandwidth output channels from 5.1-channel sources. This is done using a matrix decoder that derives 3 surround channels from the 2 in the original recording. For the best results, Dolby Digital EX should be used with movie sound tracks recorded with Dolby Digital Surround EX. With this additional channel, you can experience more dynamic and realistic moving sound especially with scenes with “fly-over” and “fly-around” effects.

■ Dolby Pro Logic II

Dolby Pro Logic II is an improved technique used to decode vast numbers of existing Dolby Surround softwares. This new technology enables a discrete 5-channel playback with 2 main left and right channels, 1 center channel, and 2 rear left and right channels (instead of only 1 rear channel for conventional Pro Logic technology). A music mode is also available for 2-channel sources in addition to the movie mode.

■ DTS (Digital Theater Systems) Digital Surround

DTS digital surround was developed to replace the analog soundtracks of movies with a 6-channel digital sound track, and is now rapidly gaining popularity in movie theaters around the world. Digital Theater Systems Inc. has developed a home theater system so that you can enjoy the depth of sound and natural spatial representation of DTS digital surround in your home. This system produces practically distortion-free 6-channel sound (technically, a left, right and center channels, 2 rear channels, plus an LFE 0.1 channel as a subwoofer, for a total of 5.1 channels).

The unit incorporates DTS-ES compatible decoder that enables 6.1-channel reproduction by adding the rear center channel to existing 5.1-channel format. (The rear center channel is created from rear left and right channels.)

■ LFE 0.1 channel

This channel is for the reproduction of low bass signals. The frequency range for this channel is 20 Hz to 120 Hz. This channel is counted as 0.1 because it only enforces a low frequency range compared to the full-range reproduced by the other 5 channels in a Dolby Digital or DTS 5.1 channel systems.

■ CINEMA DSP

Since the Dolby Surround and DTS systems were originally designed for use in movie theaters, their effect is best felt in a theater having many speakers and designed for acoustic effects. Since home conditions, such as room size, wall material, number of speakers, and so on, can differ so widely, it's inevitable that there are differences in the sound heard as well. Based on a wealth of actually measured data, YAMAHA CINEMA DSP uses YAMAHA original sound field technology to combine Dolby Pro Logic, Dolby Digital and DTS systems to provide the visual and audio experience of movie theater in the listening room of your own home.

■ SILENT CINEMA

YAMAHA has developed a natural, realistic sound effect DSP algorithm for headphones. Parameters for headphones have been set for each sound field so that accurate representations of all the sound field programs can be enjoyed using headphones.

■ Virtual CINEMA DSP

YAMAHA has developed a virtual CINEMA DSP algorithm that allows you to enjoy DSP sound field surround effects even without any rear speakers by using virtual rear speakers.

It is even possible to enjoy virtual CINEMA DSP using a minimal 2-speaker system that does not include a center speaker.

■ PCM (Linear PCM)

Linear PCM is a signal format under which an analog audio signal is digitized, recorded and transmitted without using any compression. This is used as a method of recording CDs and DVD audio. The PCM system uses a technique for sampling the size of the analog signal per very small unit of time. Standing for “pulse code modulation”, the analog signal is encoded as pulses and then modulated for recording.

■ Sampling frequency and number of quantized bits

When digitizing an analog audio signal, the number of times the signal is sampled per second is called the sampling frequency, while the degree of fineness when converting the sound level into a numeric value is called the number of quantized bits.

The range of rates that can be played back is determined based on the sampling rate, while the dynamic range representing the sound level difference is determined by the number of quantized bits. In principle, the higher the sampling frequency, the wider the range of frequencies that can be played back, and the higher the number of quantized bits, the more finely the sound level can be reproduced.

■ S-video signal

With the S-video signal system, the video signal normally transmitted using a pin cable is separated and transmitted as the Y signal for the luminance and the C signal for the chrominance through the S-video cable. Using the S VIDEO jack eliminates video signal transmission loss and allows recording and playback of even more beautiful images.

■ Component video signal

With the component video signal system, the video signal is separated into the Y signal for the luminance and the P_B/C_B and P_R/C_R signals for the chrominance. Color can be reproduced more faithfully with this system because each of these signals is independent. The component signal is also called the “color difference signal” because the luminance signal is subtracted from the color signal. A monitor with component input jacks is required in order to use the component signal for output.

SPECIFICATIONS

AUDIO SECTION

- Minimum RMS Output Power for Main, Center, Rear, Rear Center
20 Hz to 20 kHz, 0.06% THD, 8 Ω 75 W
1 kHz, 0.06% THD, 8 Ω 80 W
 - DIN Standard Output Power
[Europe model]
1 kHz, 0.7% THD, 4 Ω 125 W
 - Maximum Power (EIAJ)
[China, Korea and General models]
1 kHz, 10% THD, 8 Ω 110 W
 - Dynamic Power (IHF)
8/6/4/2 Ω 90/120/150/190 W
 - Damping Factor
20 Hz to 20 kHz, 8 Ω 80 or more
 - Frequency Response
CD to Main L/R 10 Hz to 100 kHz, -3 dB
 - Total Harmonic Distortion
20 Hz to 20 kHz, 45 W, 8 Ω, Main L/R 0.06%
 - Signal to Noise Ratio (IHF-A Network)
CD (250 mV, shorted) to Main L/R, Effect Off 100 dB
 - Residual Noise (IHF-A Network)
Main L/R 150 μV or less
 - Channel Separation (1 kHz/10 kHz)
CD (5.1 kΩ terminated) to Main L/R 60 dB/45 dB
 - Tone Control (Main L/R)
BASS Boost/Cut ±10 dB/50 Hz
TREBLE Boost/Cut ±10 dB/20 kHz
 - Phones Output 0.34 V/560 Ω
 - Input Sensitivity
CD, etc 150 mV/47 kΩ
6CH INPUT 150 mV/47 kΩ
 - Output Level
OUT (REC) 150 mV/1.2 kΩ
OUTPUT MAIN/CENTER/REAR CENTER/
REAR (SURROUND) 2.2 V/1.2 kΩ
OUTPUT SUBWOOFER 4 V/1.2 kΩ
- ## VIDEO SECTION
- Video Signal Type NTSC or PAL
 - Composite Video Signal Level 1 Vp-p/75 Ω
 - S-Video Signal Level
Y 1 Vp-p/75 Ω
C 0.286 Vp-p/75 Ω
 - Component Video Signal Level
Y 1 Vp-p/75 Ω
P_B/C_B, P_R/C_R 0.7 Vp-p/75 Ω
 - Signal to Noise Ratio 50 dB
 - Frequency Response (MONITOR OUT)
Composite, S-Video 5 Hz to 10 MHz, -3 dB
Component DC to 30 MHz, -3 dB

FM SECTION

- Tuning Range
[U.S.A. and Canada models] 87.5 to 107.9 MHz
[Other models] 87.50 to 108.00 MHz
- 50 dB Quieting Sensitivity (IHF, 100% mod.)
Mono/Stereo 2.0 μV (17.3 dBf) /25 μV (39.2 dBf)
- Selectivity (400 kHz) 70 dB
- Signal to Noise Ratio (IHF)
Mono/Stereo 76 dB/70 dB
- Harmonic Distortion (1 kHz)
Mono/Stereo 0.2%/0.3%
- Stereo Separation (1 kHz) 45 dB
- Frequency Response 20 Hz to 15 kHz +0.5, -2 dB

AM SECTION

- Tuning Range 530/531 to 1710/1611 kHz
- Usable Sensitivity 300 μV/m

GENERAL

- Power Supply
[U.S.A. and Canada models] AC 120 V/60 Hz
[Australia model] AC 240 V/50 Hz
[U.K., Europe and Singapore models] AC 230 V/50 Hz
[Korea model] AC 220 V/60 Hz
[China and General models] AC 110/120/220/240 V, 50/60 Hz
- Power Consumption
[U.S.A. and Canada models] 290 W/370 VA
[Other models] 290 W
Standby Mode approx. 0.6 W
- AC Outlets
[U.S.A., Canada, Europe and Singapore models]
..... 2 (Total 100 W maximum)
[China and General models] 2 (Total 50 W maximum)
[U.K. and Australia models] 1 (100 W maximum)
- Dimension (W x H x D)
..... 435 x 161 x 390 mm (17" x 6-7/16" x 15-3/8")
- Weight 11.5 kg (25 lbs)
- Accessories Remote control
Batteries
Front VIDEO AUX jack cap
75-ohm/300-ohm antenna adapter (U.K. model)
AM loop antenna
Indoor FM antenna

*Specifications are subject to change without notice.

LIST OF MANUFACTURER CODES

TV		ELECTRON	0941	JVC (VICTOR)	0261, 0281, 0641,	PENNY	0161, 0361, 0521,
A TANDY	0941	ELIN	1001		0651, 0661, 0841		0531, 0621, 0731,
ABEX	1151	ELTA	0331	KAWASHO	0901		0751, 0761, 0781,
ADMIRA	1141	EMERSON	0001, 0021, 0061,	KAYPANI	1021		0791, 0861, 0931,
ADVENTURA	1131		0071, 0081, 0091,	KENWOOD	0361, 1031, 1111		0941, 1031, 1041,
AIKO	1121		0111, 0811, 0821,	KLOSS	0631, 0721, 1131		1111, 1151, 1161
AIWA	1481		0831, 0841, 0851,	KTV	0921, 0941, 1011,	PEONY	1561, 1621
AKAI	0331, 1101, 1111		0861, 0871, 0901,		1051, 1111	PHILCO	0361, 0581, 0591,
ALBA	0431		0921, 0941, 0981,	LEYCO	1001		0601, 0611, 0631,
ALLERON	1091		1011, 1031, 1051,	LIESENK & TTER	1001		0961, 1031, 1111
AMBASSADOR	1081	ENVISION	1081, 1091	LLOYTRON	0941	PHILIPS	0101, 0401, 1001
AMSTRAD	0481, 1081		0361, 1111	LOEWE	1001	PHONOLA	1001
ANAM	0251, 1041, 1051,	ERRES	1001	LOGIK	0991, 1771	PILOT	0941, 1031, 1111
	1061, 1071	ETRON	0331	LUXMAN	0351, 0971	PIONEER	0511, 0551, 0871
ANAM NATIONAL	1041	FERGUSON	1001	LXI	0101, 0621, 0761,	PORTLAND	0941, 1031, 1121
AOC	0361, 1021, 1031,	FINLUX	1001		0861, 0981	PRICECLUB	0931
	1111, 1161	FISHER	0171, 0801, 0981	MAGNAVOX	0101, 0341, 0391,	PRISM	0751
ARCHER	1161	FORMENTI	0441		0401, 0411, 0421,	PROSCAN	0761
AUDIOSONIC	1001	FORMONTI	1001		0581, 0591, 0601,	PROTECH	1001
AUDIOVOX	1051, 1161	FORTRESS	1141		0611, 0631, 0661,	PROTON	0501, 0861, 0941,
BAUER	0441	FUJITSU	1091		0961, 1111		1021, 1161
BAUR	1001	FUNAI	1051, 1091, 1501,	MAJESTIC	0991	PULSAR	0891
BEIJING	1511, 1551, 1561		1521	MARANTZ	0101, 0221, 0361,	PULSER	1031
BELCOR	1031	FUTURETECH	1051		1001, 1111	QUASAR	0251, 0751, 1041
BELL & HOWELL	0981, 0991	GE	0131, 0161, 0201,	MARK	1001	QUELLE	1001
BEON	1001		0751, 0761, 0771,	MATSUI	0271, 0331, 1001	RADIO SHACK	0541, 0941,
BRADFORD	1051		0781, 0791, 0811,	MEDIATOR	1001		1031, 1051,
BROCKWOOD	1031		0861, 1041	MEGATRON	0691, 0861, 1161		1151
BROKSONIC	1161	GEC	0271, 1001	MEI	1011	RADIOLA	1001
BUSH	1001	GEMINI	0391	M-ELECTRONIC	1001	RCA	0051, 0141, 0151,
CANDLE	0351, 0361, 0961,	GENEXXA	0431	MEMOREX	0331, 0571, 0861,		0181, 0411, 0491,
	0971, 1111, 1131	GIBRALTER	0891, 1031, 1111		0971, 0981, 0991,		0531, 0761, 0771,
CAPEHART	1021	GOLDSTAR	0031, 0121, 0351,		1771		0871, 1031
CARVER	0101		0411, 0731, 0741,	METZ	1791, 1831, 1891,	REALISTIC	0541, 0861, 0941,
CATHAY	1001		0861, 0941, 0971,		1901, 1911, 1921,		0971, 0981, 1031,
CELEBRITY	0951		1001, 1031, 1111,		1931, 1941		1051, 1111, 1151
CENTURION	0411		1151	MGA	0361, 0561, 0571,	RHAPSODY	1011
CHANGHONG	1541, 1551, 1561,	GOODMANS/TASHIKO	0271, 0661, 1001		0861, 1031, 1111	R-LINE	1001
	1621	GRANADA	1001	MIDLAND	0751, 0761, 0891,	RUNCO	0891, 1111
CITIZEN	0351, 0361, 0921,	GRUNDIG	1781, 1791, 1801,		0941, 1151	SAISHO	0331, 1081
	0931, 0941, 0961,		1811, 1821, 1831,	MITSUBISHI	0221, 0321, 0561,	SAMPO	0361, 0941, 1021,
	0971, 1111, 1121,		1841, 1851, 1861,		0571, 0661, 0861,		1111, 1151
	1131		1871, 1881		1031, 1101, 1381	SAMSUNG	0331, 0341, 0351,
CLAIRTONE	1011	GUNPY	1051, 1091	MONTGOMERY	1091		0361, 0861, 0931,
CLARIVOX	1001	HARMAN/KARDON	0721	MOTOROLA	1041, 1141		0941, 0971, 1001,
CONCERTO	0351, 0971	HALLMARK	0861	MTC	0351, 0361, 0881,	SAMSUX	0941
CONROWA	1751	HANSEATIC	1001		0931, 0971, 1011,	SANYO	0171, 0231, 0271,
CONTEC	0901, 0911, 1011,	HARVARD	1051, 1061	MULTITECH	1031, 1111		0661, 0801, 0911,
	1051	HINARI	1001, 1091	NAD	0881, 1051		0981, 1231, 1251,
CORANDO	0941	HITACHI	0181, 0351, 0671,	NEC	0551, 0621, 0861		1261
CRAIG	0251, 1051		0681, 0691, 0701,		0241, 0351, 0361,	SBR	1001
CROWN	0941, 1051		0711, 0871, 0941,		0661, 0971, 1031,	SCHEIDER	1001
CURTIS MATHES	0161, 0361,		0971, 1351	NECKERMANN	1111, 1321, 1711	SCIMITSU	1031
	0931, 0941,	HYPSON	1001	NEI	1001	SCOTCH	0861
	0981, 1111	IMA	1051	NIKKAI	0271, 0431, 1001,	SCOTT	0831, 0861, 0941,
CXC	1051	INDIANA	1001		1151		1031, 1051, 1091
DAEWOO	0291, 0301, 0331,	INFINITY REFERENCE	0101	NIKKO	0861, 1111, 1121	SEARS	0101, 0161, 0171,
	0721, 0941, 1001,		1001	NOVABEAM	0721		0351, 0481, 0521,
	1031, 1121, 1191,	INTERFUNK	1001	NTC	1121		0621, 0761, 0801,
	1531, 1581, 1591,	ITT	0611	ONWA	1051		0861, 0971, 0981,
	1601	JANEIL	1131	OPTIMUS	0551		1091
DANSAI	1001	JBL	0101	OPTONICA	0541, 1141	SHANGHAI	1561, 1681
DAYTRON	0941, 1031	JCB	0951	ORION	0831, 1001	SHARP	0461, 0471, 0541,
DECCA	0271, 1001	JENSEN	0311	OSAKI	0271, 1151		0661, 0911, 0941,
DIXI	0331, 1001, 1071	JINXING	1531, 1541, 1551,	OTTO VERSAND	1001		1141
DUMONT	0891, 1031		1561, 1571, 1621,	PANASONIC	0101, 0191, 0251,	SHOGUN	1031
DYNATECH	0881		1631, 1641, 1651,		0751, 1041, 1311,	SIGNATURE	0991, 1771
ELECTROBAND	0951, 1011		1691, 1731		1371, 1431	SIMPSON	0581, 0961
ELECTROHOME	0941			PANDA	1541, 1721	SOLAVOX	1151
						SONOKO	1001

SONTEC 1001
 SONY 0371, 0451, 0661, 0841, 0951, 1281, 1441
 SOUNDESIGN 0861, 0961, 1051, 1091
 SOUNDWAVE 1001
 SPECTRICON 1161
 SQUAREVIEW 0481
 SSS 1031, 1051
 STAR-LITE 1051
 SUPREM 0951
 SUPRE-MACY 1131
 SURPA 0351, 0971
 SYLVANIA 0101, 0361, 0441, 0581, 0591, 0601, 0611, 0631, 0961, 1111
 SYMPHONIC 0481
 SYSLINE 1001
 TANDY 0271, 0431, 1141
 TATUNG 0271, 0881, 1001, 1041, 1161
 TCL 1561, 1631, 1701
 TECHNICS 0751
 TECHWOOD 0351, 0751, 0971
 TEKNIKA 0101, 0351, 0571, 0931, 0941, 0961, 0971, 0991, 1031, 1051, 1091, 1121, 1131, 1771
 TELETECH 0331
 TERA 0501
 THAKRAL 1671
 THORM 1001
 TMK 0351, 0861, 0971, 1081
 TOSHIBA 0381, 0521, 0621, 0661, 0931, 0981, 1301
 TOSONIC 1011
 TOTEVISION 0941
 TRICAL 0911
 UNIVERSAL 0781, 0791
 UNIVERSUM 1001
 VECTOR RESEARCH 0361, 1111
 VESTEL 1001
 VIDEO CONCEPT 1101
 VIDIKRON 0101, 0211
 VIDTECH 0861, 1031
 VIKING 1131
 WARDS 0101, 0361, 0451, 0541, 0581, 0591, 0601, 0611, 0771, 0781, 0791, 0861, 0971, 0991, 1031, 1091, 1111, 1771
 WATSON 1001
 XOGEGO 1611, 1621, 1661, 1741, 1761
 YAMAHA 0361, 1031, 1111
 YOKO 1001
 ZENITH 0011, 0041, 0891, 0991, 1771
 ZONDA 1161

CABLE TV

ABC 0256, 0376
 ANTRONIX 0136
 ARCHER 0136, 0286
 BBT 0076
 CABLETIME 0166
 CABLEVISION 0196
 COLOUR VOICE 0306, 0346
 COMTRONICS 0216, 0276
 EAGLE COMTRONICS 0276
 EASTERN 0066
 ELECTRICORD 0206
 ELECTUS 0266
 GE 0116, 0126
 GEC CABLE SYSTEM 0196
 HAMLIN H5 0676
 HAMLIN H6 0666
 HAMLIN H6S 0656
 HAMLIN H8 0646
 HAMLIN H9 0636
 JERROLD 0256
 JERROLD 400L 0626
 JERROLD 450L 0616
 JERROLD 550 0606
 JERROLD OSD CATV 0596
 JERROLD SPRUCER 0436
 MAGNAVOX/PHILIPS 0416, 0426
 MAMM 0296
 MEMOREX 0386
 MOVIE TIME 0146, 0206
 NORTHCOAST 0016
 NSC 0146
 OAK 0106
 OAK SIGMA 450 0546
 OAK SIGMA 550 0536
 PANASONIC TZ 120/130 0476
 PANASONIC TZ 170/180 0446
 PANASONIC TZ140 0466
 PANASONIC TZ150/160 0456
 PARAGON 0386
 PHILIPS 0036, 0216, 0306, 0316, 0326, 0336, 0346
 PIONEER 0006, 0086
 PIONEER BR50 0846
 PIONEER BR60/70/80/81/82 0696
 PIONEER BR90 0556
 PULSAR 0386
 RCA DIGITAL SATELLITE SYSTEM 0396, 0406
 REALISTIC 0136
 REGENCY/EASTERN 0686
 RUNCO 0386
 SAMSUNG 0276
 SCIENTIFIC ATLANTA 175/475 0576
 SCIENTIFIC ATLANTA 75 0366, 0586
 SCIENTIFIC ATLANTA 8650 0566
 SIGNAL 0276
 SL MARX 0276
 SPECTAVISION 0236
 STANDARD COMPONENTS 0186

STARCOM V 0256
 STARGATE 0276
 SYLVANIA/TEXSCAN 0376, 0496
 TEKNIKA 0176
 TELESERVICE 0056
 TELEVIEW 0276
 TEXSCAN 0186, 0376
 TFC 0026
 TOCOM 0226, 0356
 TOCOM 5503A 0526
 TOCOM 5503VIP/5507 0516
 TOCOM TC56 0506
 TOSHIBA 0386
 TUDI 0046
 UNIKA 0136
 UNIVERSAL 0136, 0156, 0206, 0286
 VIDEOWAY 0096
 VIEWSTAR 0216
 ZENITH 0246, 0386, 0486

SATELLITE TUNER

ALPHA STAR 0826
 CHAPARRAL 0756
 ECHOSTAR 0836
 GENERAL INSTRUMENT 0776, 0876
 HTS 0836
 HUGHES NETWORK SYSTEMS 0816
 JERROLD 0776, 0786
 PANASONIC 0806
 PRIMESTAR 0776, 0786
 RCA 0766
 SONY 0796
 (DBS)
 HITACHI 0856
 MAGNAVOX 0886
 MEMOREX 0886
 PANASONIC 0896
 PHILIPS 0886
 SONY 0906
 STAR CHOICE 0876
 TOSHIBA 0866, 0916
 UNIDEN 0886

VCR

A TANDY 0902
 ADVENTURA 0992
 AIKO 0982
 AIWA 0992
 AKAI 0262, 0942, 0952, 0962, 0972
 AMERICAN HIGH 0932
 AMSTRAD 0992
 ASA 0002, 0912
 ASHA 0922
 AUDIO DYNAMICS 0202
 AUDIOVOX 0912
 BEAUMARK 0922
 BELL & HOWELL 0902
 BLAUPUNKT 0412
 BROKSONIC 0872, 0882, 0892
 BUSH 0852
 CALIX 0912
 CANON 0862, 0932
 CCE 0852, 0982
 CITIZEN 0912, 0982
 COLT 0852
 CRAIG 0832, 0842, 0852, 0912, 0922

CURTIS MATHES 0662, 0822, 0932
 CYBERNEX 0922
 DAEWOO 0802, 0812, 0982
 DBX 0202
 DYNATECH 0472, 0992
 ELECTROHOME 0912
 ELECTROPHONIC 0912
 EMEREX 0792
 EMERSON 0072, 0132, 0142, 0152, 0162, 0172, 0182, 0192, 0212, 0702, 0712, 0722, 0732, 0742, 0752, 0762, 0772, 0782, 0872, 0882, 0892, 0912, 0952, 0992, 1072
 FINLUX 0002, 0992
 FISHER 0682, 0692, 0842, 0902
 FUJI 0672, 0932
 FUNAI 0992
 GARRARD 0992
 GE 0662, 0822, 0932
 GO VIDEO 0642, 0652
 GOLDSTAR 0082, 0632, 0912
 GOODMANS 0402
 GRADIENTE 0992
 GRANDA 0612, 0902
 GRUNDIG 0002
 HARLEY DAVIDSON 0992
 HARMAN/KARDON 0632, 1082
 HARWOOD 0752, 0852
 HEADQUARTER 0612
 HI-Q 0842
 HINARI 0852
 HITACHI 0102, 0562, 0572, 0582, 0592, 0602, 0992
 ITT 0942
 JVC (VICTOR) 0202, 0522, 0532, 0542, 0552
 KENWOOD 0202, 0542, 0612, 0632, 0902
 KLH 0852
 KODAK 0912, 0932
 LLOYD 0992
 LOGIK 0852
 LUXOR 0942
 LXI 0022, 0912
 MAGNAVOX 0002, 0482, 0492, 0502, 0512, 0932
 MAGNIN 0922
 MARANTZ 0002, 0202, 0402, 0632, 0932
 MARTA 0912
 MATSUSHITA 0932
 MATSUI 0722
 MEI 0222, 0932
 MEMOREX 0232, 0242, 0472, 0512, 0612, 0842, 0902, 0912, 0922, 0932, 0992
 MGA 0762, 0952
 MGA TECHNOLOGY 0922
 MINOLTA 0592, 0602
 MITSUBISHI 0452, 0462, 0542, 0762, 0952, 1082
 MOTOROLA 0472, 0932
 MTC 0922, 0992

MULTITECH	0852, 0992	TEAC	0992	CD PLAYER	REALISTIC	0205, 0225, 0235, 0325, 0555, 0845
NAD	0442	TECHNICS	0932	ACOUSTIC RESEARCH	REVOX	1175
NEC	0122, 0202, 0292, 0422, 0432, 0542, 0632	TEKNIKA	0322, 0912, 0932, 0992	ADC	ROTEL	1215
NIKKO	0912	TELEFUNKEN	0252	ADCOM	SABA TELECOMMANDER (E)	0505
NOBLEX	0922	TMK	0212, 0732, 0772, 0922	ADS	SAE	0215
OLYMPUS	0412, 0932	TOSHIBA	0062, 0302, 0342, 0622, 0682, 0712, 0762	AIWA	SAMSUNG	1285
OPTIMUS	0442, 0472, 0912	TOTEVISION	0912, 0922	AKAI	SANSUI	0215, 0625, 0975, 1025, 1105
OPTONICA	0402	UNITECH	0922	ALPINE	SANYO	0145, 0555, 0635, 0765
ORION	0212, 0722, 0742, 0772	VECTOR RESEARCH	0202, 0432, 0632	AUDIO-TECHNICA	SCOTT	0325, 1105
OSAKI	0912	VIDEO CONCEPTS	0202, 0432, 0632, 0952	BSR	SEARS	0345
PANASONIC	0012, 0052, 0092, 0222, 0372, 0382, 0392, 0412, 0932	WARDS	0322, 0402, 0472, 0482, 0602, 0712, 0842, 0852, 0922, 0932, 0992	CALIFORNIA AUDIO LAB	SHARP	0235, 0665, 0895, 1065, 1075
PENNY	0202, 0432, 0602, 0632, 0692, 0912, 0922, 0932	YAMAHA	0202, 0632	CAPETRONIC	SHERWOOD	0115, 0235, 0395, 0475
PENTAX	0592, 0602	ZENITH	0042, 0362, 0512, 0672	CARRERA	SIEMENS GARRARD	1245
PERDIO	0992			CARVER	SIGNATURE	0175
PHILCO	0002, 0932			CASIO	SONTEC	1165
PHILIPS	0002, 0282, 0402, 0492, 0932			CROWN	SONY	0065, 0565, 0865, 1145
PILOT	0912			CURTIS MATHES	STARON	1235
PIONEER	0442, 0542			DENON	STS	0025
PROSCAN	1002, 1012, 1022, 1032, 1042, 1052, 1062			DEUAL (E)	SYLVANIA	0215
PULSAR	0512			DYNAMIC BASS (H)	SYMPHONIC	0335
QUARTER	0612			EMERSON	TANDY	0305
QUARTZ	0272, 0612			EROICA	TANGBERG	1195
QUASAR	0382, 0392, 0932			FISHER	TEAC	0235, 0335, 0385, 0525, 0795, 0835, 1355
RADIO SHACK	0912, 0992			GARRARD	TECHNICS	0055, 0605, 1095
RADIX	0912			GENEXXA	TECHWOOD	1325
RANDEX	0912			GOLDSTAR	TELEFUNKEN (E)	0505
RCA	0112, 0382, 0392, 0482, 0592, 0602, 0662, 0822, 0942			HARMAN/KARDON	THOMSON (E)	0505
REALISTIC	0402, 0472, 0612, 0682, 0842, 0902, 0912, 0922, 0932, 0992			HITACHI	TOSHIBA	0035, 0685
RICOH	0352, 0362			INKEL	VECTOR RESEARCH	0065, 1135
SAISHO	0212, 0582, 0722, 0732, 0742, 0772			JVC (VICTOR)	WARDS	0175
SALORA	0612, 0762			KENWOOD	YAMAHA	0005, 0015, 0085, 0415, 0545, 0575, 1065
SAMSUNG	0212, 0312, 0922, 0962			KYOCERA		
SANKY	0472, 0512			LUXMAN		
SANSUI	0292, 0542, 0832			MAGNAVOX		
SANYO	0242, 0612, 0842, 0902, 0922			MARANTZ		
SBR	0002, 0282			MCINTOSH		
SCHEIDER	0852			MCS		
SCOTT	0342, 0712, 0762, 0872, 0882, 0892			MEMOREX		
SEARS	0302, 0592, 0602, 0612, 0682, 0692, 0842, 0902, 0912, 0932			MGA		
SHARP	0402, 0472			MISSION		
SHINTOM	0852			MITSUBISHI		
SHOGUN	0922			MTC		
SINGER	0852			NAD		
SONY	0032, 0332, 0352, 0362, 0672, 0792, 0932			NAKAMICHI		
STS	0602			NEC		
SUNPAK	0352			NIKKO		
SYLVANIA	0002, 0492, 0502, 0762, 0932, 0992			ONKYO		
SYMPHONIC	0992			OPTIMUS		
TANDY	0992			PANASONIC		
TASHIKO	0712, 0992			PENNY		
				PHILIPS		
				PIONEER		
				PROTON		
				QUASAR		
				RCA		

DVD PLAYER

AKAI	0058
DENON	0188
HITACHI	0198
JVC (VICTOR)	0088, 0178
KENWOOD	0148
MAGNAVOX	0128
mitsubishi	0138
ONKYO	0068, 0128
PANASONIC	0028
PHILIPS	0098, 0128
PIONEER	0108, 0118
PROSCAN	0158
RCA	0158
SAMSUNG	0078
SHARP	0038
SONY	0018
TECHNICS	0028
THOMSON	0168
TOSHIBA	0048, 0128
YAMAHA	0008, 0028, 0098
ZENITH	0128

LD PLAYER

AIWA	0157
DENON	0147
DISCO VISION	0017
FUNAI	0157
HITACHI (E)	0017
KENWOOD	0087, 0107
MAGNAVOX	0027
MARANTZ	0027
MITSUBISHI	0137
NAD	0137
PANASONIC	0077, 0177
PHILIPS	0027
PIONEER	0017, 0037, 0137
RCA	0167
REALISTIC	0157
SHARP	0127
SONY	0047, 0057, 0117
VICTOR	0097
YAMAHA	0007, 0067

CD RECORDER/CD-RW

HITACHI	0474
JVC (VICTOR)	0504
MARANTZ	0484, 0494
PHILIPS	0444
PIONEER	0454, 0464
YAMAHA	0414

MD RECORDER

KENWOOD	0384
PIONEER	0424
SHARP	0434
SONY	0394
YAMAHA	0024, 0394, 0404

TAPE DECK

AIWA	0094, 0214, 0224
AKAI	0184
CARVER	0094
DENON	0304
FISHER	0144
GARRARD	0194, 0204
JVC (VICTOR)	0274, 0284, 0294
KENWOOD	0124, 0134, 0154, 0234, 0244, 0264
MAGNAVOX	0094
MARANTZ	0094, 0344
MITSUBISHI	0184
OPTIMUS	0034, 0064, 0204, 0334
ONKYO	0364, 0374
PHILIPS	0094
PIONEER	0034, 0044, 0064
REVOX	0354
SANSUI	0094, 0344
SHARP	0264
SHERWOOD	0334
SONY	0054, 0084, 0324
TEAC	0194, 0254
TECHNICS	0074, 0314
WARDS	0034
YAMAHA	0004, 0014, 0104, 0114, 0164, 0174, 0264



YAMAHA ELECTRONICS CORPORATION, USA 6660 ORANGETHORPE AVE., BUENA PARK, CALIF. 90620, U.S.A.
YAMAHA CANADA MUSIC LTD. 135 MILNER AVE., SCARBOROUGH, ONTARIO M1S 3R1, CANADA
YAMAHA ELECTRONIK EUROPA G.m.b.H. SIEMENSSTR. 22-34, 25462 RELINGEN BEI HAMBURG, F.R. OF GERMANY
YAMAHA ELECTRONIQUE FRANCE S.A. RUE AMBROISE CROIZAT BP70 CROISSY-BEAUBOURG 77312 MARNE-LA-VALLEE CEDEX02, FRANCE
YAMAHA ELECTRONICS (UK) LTD. YAMAHA HOUSE, 200 RICKMANSWORTH ROAD WATFORD, HERTS WD1 7JS, ENGLAND
YAMAHA SCANDINAVIA A.B. J A WETTERGRENS GATA 1, BOX 30053, 400 43 VÄSTRA FRÖLUNDA, SWEDEN
YAMAHA MUSIC AUSTRALIA PTY, LTD. 17-33 MARKET ST., SOUTH MELBOURNE, 3205 VIC., AUSTRALIA

YAMAHA CORPORATION
Printed in Malaysia **UP** VIDEO V874870

Free Manuals Download Website

<http://myh66.com>

<http://usermanuals.us>

<http://www.somanuals.com>

<http://www.4manuals.cc>

<http://www.manual-lib.com>

<http://www.404manual.com>

<http://www.luxmanual.com>

<http://aubethermostatmanual.com>

Golf course search by state

<http://golfingnear.com>

Email search by domain

<http://emailbydomain.com>

Auto manuals search

<http://auto.somanuals.com>

TV manuals search

<http://tv.somanuals.com>