



HTR-5630RDS

AV Receiver

Ampli-tuner audio-vidéo

OWNER'S MANUAL
MODE D'EMPLOI
BEDIENUNGSANLEITUNG
BRUKSANVISNING
MANUALE DI ISTRUZIONI
MANUAL DE INSTRUCCIONES
GEBRUIKSAANWIJZING

CAUTION: READ THIS BEFORE OPERATING YOUR UNIT.

- 1 To assure the finest performance, please read this manual carefully. Keep it in a safe place for future reference.
- 2 Install this sound system in a well ventilated, cool, dry, clean place — away from direct sunlight, heat sources, vibration, dust, moisture, and/or cold. Allow ventilation space of at least 30 cm on the top, 20 cm on the left and right, and 20 cm on the back of this unit.
- 3 Locate this unit away from other electrical appliances, motors, or transformers to avoid humming sounds.
- 4 Do not expose this unit to sudden temperature changes from cold to hot, and do not locate this unit in a environment with high humidity (i.e. a room with a humidifier) to prevent condensation inside this unit, which may cause an electrical shock, fire, damage to this unit, and/or personal injury.
- 5 Avoid installing this unit where foreign object may fall onto this unit and/or this unit may be exposed to liquid dripping or splashing. On the top of this unit, do not place:
 - Other components, as they may cause damage and/or discoloration on the surface of this unit.
 - Burning objects (i.e. candles), as they may cause fire, damage to this unit, and/or personal injury.
 - Containers with liquid in them, as they may fall and liquid may cause electrical shock to the user and/or damage to this unit.
- 6 Do not cover this unit with a newspaper, tablecloth, curtain, etc. in order not to obstruct heat radiation. If the temperature inside this unit rises, it may cause fire, damage to this unit, and/or personal injury.
- 7 Do not plug in this unit to a wall outlet until all connections are complete.
- 8 Do not operate this unit upside-down. It may overheat, possibly causing damage.
- 9 Do not use force on switches, knobs and/or cords.
- 10 When disconnecting the power cord from the wall outlet, grasp the plug; do not pull the cord.
- 11 Do not clean this unit with chemical solvents; this might damage the finish. Use a clean, dry cloth.
- 12 Only voltage specified on this unit must be used. Using this unit with a higher voltage than specified is dangerous and may cause fire, damage to this unit, and/or personal injury. YAMAHA will not be held responsible for any damage resulting from use of this unit with a voltage other than specified.
- 13 To prevent damage by lightning, disconnect the power cord from the wall outlet during an electrical storm.
- 14 Do not attempt to modify or fix this unit. Contact qualified YAMAHA service personnel when any service is needed. The cabinet should never be opened for any reasons.
- 15 When not planning to use this unit for long periods of time (i.e. vacation), disconnect the AC power plug from the wall outlet.
- 16 Be sure to read the “TROUBLESHOOTING” section on common operating errors before concluding that this unit is faulty.
- 17 Before moving this unit, press **STANDBY/ON** to set this unit in standby mode, and disconnect the AC power plug from the wall outlet.
- 18 **VOLTAGE SELECTOR** (General model only)
The **VOLTAGE SELECTOR** on the rear panel of this unit must be set for your local main voltage **BEFORE** plugging into the AC main supply. Voltages are 110V-120V, 220V-240V AC, 50/60 Hz.

This unit is not disconnected from the AC power source as long as it is connected to the wall outlet, even if this unit itself is turned off. This state is called standby mode. In this state, this unit is designed to consume a very small quantity of power.

WARNING

TO REDUCE THE RISK OF FIRE OR ELECTRIC SHOCK, DO NOT EXPOSE THIS UNIT TO RAIN OR MOISTURE.

■ For U.K. customers

If the socket outlets in the home are not suitable for the plug supplied with this appliance, it should be cut off and an appropriate 3 pin plug fitted. For details, refer to the instructions described below.

Note

- The plug severed from the mains lead must be destroyed, as a plug with bared flexible cord is hazardous if engaged in a live socket outlet.

■ Special Instructions for U.K. Model

IMPORTANT

THE WIRES IN MAINS LEAD ARE COLOURED IN ACCORDANCE WITH THE FOLLOWING CODE:

Blue: NEUTRAL

Brown: LIVE

As the colours of the wires in the mains lead of this apparatus may not correspond with the coloured markings identifying the terminals in your plug, proceed as follows:

The wire which is coloured BLUE must be connected to the terminal which is marked with the letter N or coloured BLACK. The wire which is coloured BROWN must be connected to the terminal which is marked with the letter L or coloured RED.

Making sure that neither core is connected to the earth terminal of the three pin plug.

CONTENTS

INTRODUCTION

CONTENTS	1
FEATURES	2
GETTING STARTED	3
Supplied accessories	3
Installing batteries in the remote control	3
CONTROLS AND FUNCTIONS	4
Front panel	4
Remote control	6
Front panel display	8

PREPARATION

CONNECTIONS	9
Before connecting components	9
Connecting video components	10
Connecting audio components	11
Connecting the antennas	12
Connecting an external decoder	13
Connecting the speakers	14
Connecting the power supply cords	17
Turning on the power	17
BASIC SYSTEM SETTINGS	18
Using the basic menu	18
Setting the unit to match your speaker system	20
Setting speaker output levels (SP LEVEL)	20

BASIC OPERATION

PLAYBACK	21
Input modes and indications	23
Selecting a sound field program	24
DIGITAL SOUND FIELD PROCESSING (DSP)	27
Understanding sound fields	27
Hi-Fi DSP programs	27
CINEMA-DSP	28
Sound design of CINEMA-DSP	28
CINEMA-DSP Programs	28
Sound field effects	30
TUNING	31
Presetting stations	32
Selecting a preset station	34
RECEIVING RDS STATIONS	35
Description of RDS data	35
Changing the RDS mode	35
PTY SEEK function	36
EON function	36
SLEEP TIMER	37
RECORDING	38

ADVANCED OPERATION

SET MENU	39
Set menu list	39
Adjusting the items on the set menu	39
SOUND 1 SPEAKER SET (speaker mode settings)	40
SOUND 2 SP DISTANCE (speaker distance)	42
SOUND 3 LFE LEVEL	42
SOUND 4 D. RANGE (dynamic range)	42
SOUND 5 CENTER GEQ	43
(center graphic equalizer)	43
SOUND 6 HP TONE CTRL	43
(headphone tone control)	43
INPUT 1 I/O ASSIGN (input/output assignment) ..	43
INPUT 2 INPUT MODE (initial input mode)	43
OPTION 1 DISPLAY SET	44
OPTION 2 MEM. GUARD (memory guard)	44
OPTION 3 AUDIO MUTE	44
SETTING THE SPEAKER LEVELS	45
Adjusting the volume during playback	45
Using the test tone	45

ADDITIONAL INFORMATION

SOUND FIELD PROGRAM PARAMETER EDITING	46
Changing parameter settings	46
Digital sound field parameter descriptions	47
TROUBLESHOOTING	48
GLOSSARY	52
SPECIFICATIONS	54

FEATURES

Built-in 5-channel power amplifier

- ◆ Minimum RMS output power (0.1% THD, 1 kHz, 6Ω)
[U.S.A. and Canada models]
Main: 70 W + 70 W
Center: 70 W
Rear: 70 W + 70 W
[Other models]
Main: 60 W + 60 W
Center: 60 W
Rear: 60 W + 60 W

Multi-mode digital sound field processing

- ◆ Dolby Pro Logic/Dolby Pro Logic II decoder
- ◆ Dolby Digital/Dolby Digital + Matrix 6.1 Decoder
- ◆ DTS/DTS + Matrix 6.1 Decoder
- ◆ CINEMA DSP: Combination of YAMAHA DSP technology and Dolby Pro Logic, Dolby Digital or DTS
- ◆ Virtual CINEMA DSP
- ◆ SILENT CINEMA DSP

Sophisticated AM/FM Tuner

- ◆ 40-Station random access preset tuning
- ◆ Automatic preset tuning
- ◆ Preset station shifting capability (Preset editing)

Other features

- ◆ 96 kHz/24-bit D/A converter
- ◆ Set menu for optimizing this unit for your Audio/Video system
- ◆ Test tone generator for easier speaker balance adjustment
- ◆ 6-channel external decoder input
- ◆ Optical and coaxial digital audio signal jacks
- ◆ Sleep timer

■ About this manual

-  indicates a tip for your operation.
- Some operations can be performed by using either the buttons on the main unit or on the remote control. In cases when the button names differ between the main unit and the remote control, the button name on the remote control is given in parentheses.
- This manual is printed prior to production. Design and specifications are subject to change in part for the reason of the improvement in operativity ability, and others. In this case, the product has priority.



Manufactured under license from Dolby Laboratories.

“Dolby”, “Pro Logic”, and the double-D symbol are trademarks of Dolby Laboratories.



“DTS” and “DTS Digital Surround” are registered trademarks of Digital Theater Systems, Inc.

GETTING STARTED

Supplied accessories

After unpacking, check that the following parts are contained.

Remote control

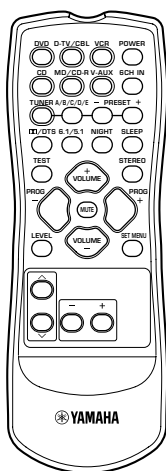

Batteries (2) (AA, R06, UM-3)

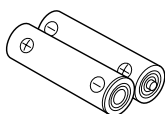

AM loop antenna

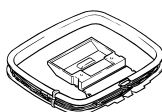

Indoor FM antenna (U.S.A., Canada, China, Korea and General models)

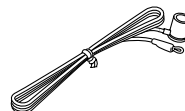

(Europe, U.K., Australia and Singapore models)

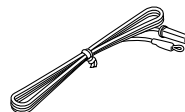

Installing batteries in the remote control

Insert the batteries in the correct direction by aligning the + and - marks on the batteries with the polarity markings (+ and -) inside the battery compartment.

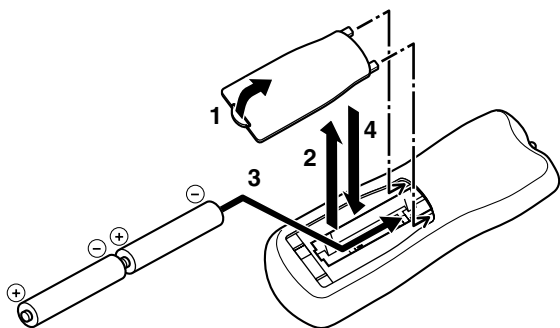

- 1** Press the tab of the battery compartment cover and pull it in the direction of the arrow to open the cover.
- 2** Remove the cover.
- 3** Insert the two batteries supplied (AA, R06, UM-3) according to the polarity markings on the inside of the battery compartment.
- 4** Put the cover back into place.

■ Notes on batteries

- Change all of the batteries if you notice a decrease in the operating range of the remote control.
- Do not use old batteries together with new ones.
- Do not use different types of batteries (such as alkaline and manganese batteries) together. Read the packaging carefully as these different types of batteries may have the same shape and color.
- If the batteries have leaked, dispose of them immediately. Avoid touching the leaked material or letting it come into contact with clothing, etc. Clean the battery compartment thoroughly before installing new batteries.

CONTROLS AND FUNCTIONS

Front panel

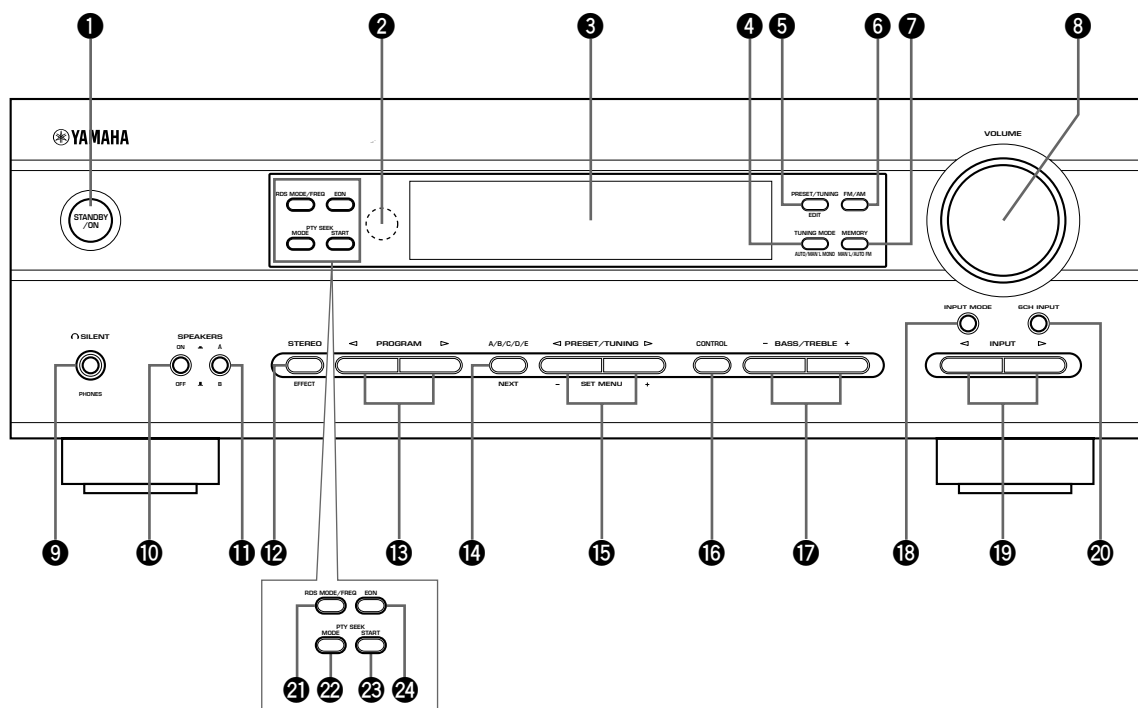

(U.K. and Europe models only)

1 STANDBY/ON

Turns the unit on, or sets it in standby mode. When you turn the unit on, you will hear a click and there will be a 4 to 5-second delay before it can reproduce sound.

Standby mode

In this mode, the unit uses a small amount of power in order to receive infrared-signals from the remote control.

2 Remote control sensor

Receives signals from the remote control.

3 Front panel display

Shows information about the operational status of the unit.

4 TUNING MODE (AUTO/MAN'L MONO)

Switches the tuning mode between automatic and manual.

5 PRESET/TUNING (EDIT)

Switches the function of PRESET/TUNING </> between selecting a preset station number and tuning (the colon (:)) turns on or off).

This button is also used to exchange the assignment of two preset stations with each other.

6 FM/AM

Switches the reception band between FM and AM.

7 MEMORY (MAN'L/AUTO FM)

Stores the current station in memory.

8 VOLUME

Controls the output level of all audio channels. This does not affect the OUT (REC) level.

9 SILENT (PHONES jack)

Allows you to enjoy DSP effects when listening with headphones.

Inserting the plug from your headphones into the PHONES jack does not affect the sound output from the speakers. If you wish to stop the signal output to the speakers, press SPEAKERS ON/OFF so that it is in the OFF position.

10 SPEAKERS ON/OFF

Turns on or off the speakers that you selected by SPEAKERS A/B.

11 SPEAKERS A/B

Selects the set of main speakers connected to the A or B terminals.

12 STEREO (EFFECT)

Switches between normal stereo and DSP effect reproduction. When you select STEREO, the unit mixes down all Dolby Digital and DTS signals (except the LFE channel) as well as those 2-channel signals without effects, to the main left and right speakers.

13 PROGRAM ◀/▶

Select the DSP program.

14 A/B/C/D/E

Selects preset station groups A to E when the unit is in tuner mode.

NEXT

Selects the set menu mode when the unit is not in tuner mode.

15 PRESET/TUNING ◀/▶

Select preset station numbers 1 to 8 when a colon (:) is displayed in the front panel display.

Select the tuning frequency when a colon (:) is not displayed when the unit is in tuner mode.

SET MENU -/+

Adjust settings on the set menu when the unit is not in tuner mode.

16 CONTROL

Switches between Bass (low-frequency response) control mode and Treble (high-frequency response) control mode.

17 BASS/TREBLE -/+

Increase or decrease low/high-frequency response when the unit is in Bass/Treble control mode. The sound changes 2dB each time you press one of these buttons. Control range: -10 to +10dB.

18 INPUT MODE

Sets the priority for the types of input signals (AUTO, DTS, ANALOG) received when one component is connected to two types of input jacks. You cannot set priority for an audio sources if you have selected 6CH INPUT as the input source.

19 INPUT ◀/▶

Selects the input source you want to listen to or watch.

20 6CH INPUT

Selects the audio source connected to the 6CH INPUT jacks. This selection takes priority over sources selected with INPUT (or the input selector buttons on the remote control).

(U.K. and Europe models only)**21 RDS MODE/FREQ**

Press this button when the unit is receiving an RDS station, to cycle the display mode among PS mode, PTY mode, RT mode, CT mode (if the station offers those RDS data service) and/or frequency display mode in turn.

22 PTY SEEK MODE

Press this button to set the unit in the PTY SEEK mode.

23 PTY SEEK START

Press this button to begin searching for a station after the desired program type has been selected in the PTY SEEK mode.

24 EON

Press this button to select a radio program type (NEWS, INFO, AFFAIRS, SPORT) to tune in automatically.

Remote control

This section describes the remote control controls and their functions.

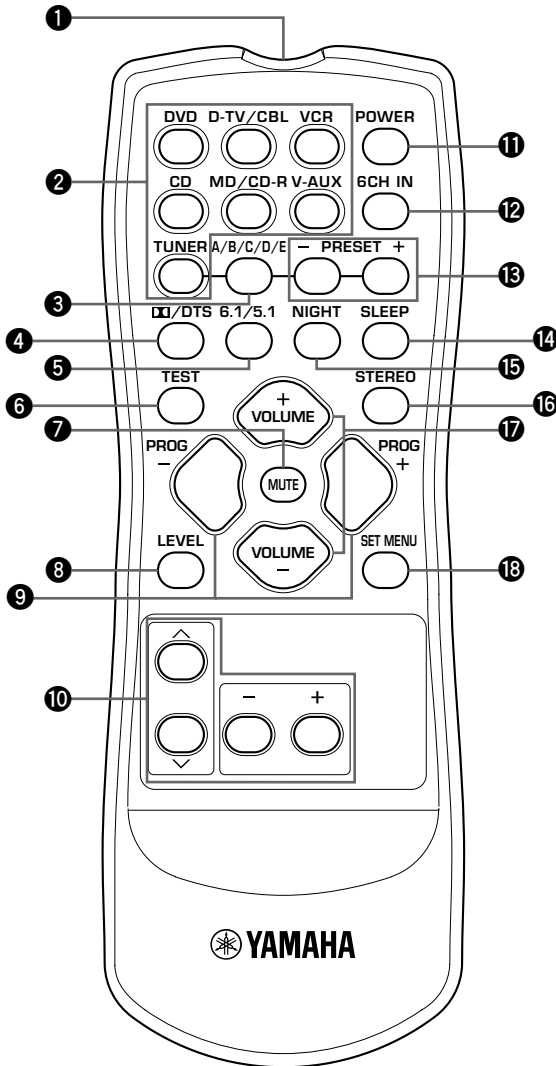

1 Infrared emitter

Outputs infrared control signals. Aim this emitter at the unit when using the remote control.

2 Input selector buttons

Select the input source.

3 A/B/C/D/E

Selects preset station groups A to E when the unit is in tuner mode.

4 D/DTS

Selects the built-in Dolby Digital, DTS, Dolby Pro Logic or Pro Logic II decoder.

5 6.1/5.1

Switches on or off the Dolby Digital + Matrix 6.1 or DTS + Matrix 6.1 decoder.

6 TEST

Outputs a test tone for use when adjusting the speaker levels.

7 MUTE

Mutes the sound. Press again to restore the audio output to the previous volume level.

8 LEVEL

Selects the effect speaker channel to adjust.

9 PROGRAM -/+

Select the DSP program.

10 Multi control section

Used to change and implement settings.

11 POWER

Turns the unit on, or sets it in standby mode.

12 6CH IN

Selects the audio source connected to the 6CH INPUT jacks.

13 PRESET -/+

Select preset station numbers 1 to 8.

14 SLEEP

Sets the sleep timer.

15 NIGHT

Sets the unit in night listening mode.

16 STEREO

Switches between normal stereo and DSP effect reproduction. When you select STEREO the unit mixes down all Dolby Digital and DTS signals (except the LFE channel) as well as those 2-channel signals without effect sounds, to the main left and right speakers.

17 VOLUME +/-

Increases or decreases the volume level.

18 SET MENU

Selects the set menu mode.

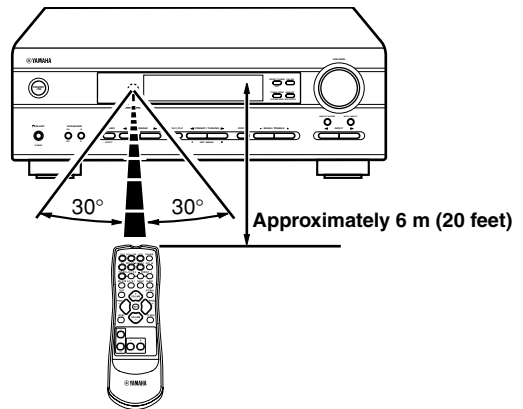
■ Using the remote control

The remote control transmits a directional infrared beam. Be sure to aim the remote control directly at the remote control sensor on the main unit during operation.

■ Handling the remote control

- Do not spill water or other liquids on the remote control.
- Do not drop the remote control.
- Do not leave or store the remote control in the following types of conditions:
 - high humidity or temperature such as near a heater, stove or bath;
 - dusty places; or
 - in places subject to extremely low temperatures.

Front panel display

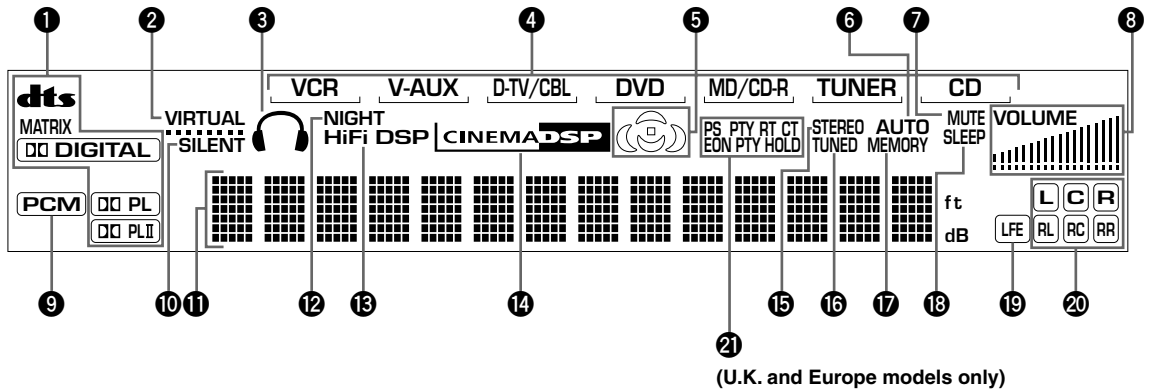

1 Processor indicators

The indicators for the various decoders light up when the decoders are in use.

2 VIRTUAL indicator

Lights up when using Virtual CINEMA DSP.

3 Headphones indicator

Lights up when headphones are connected to the headphone jack.

4 Input source indicator

Highlights the current input source with a cursor.

5 Sound field indicator

Displays the sound field management the unit is using when you listen to a DSP sound field program.

6 AUTO indicator

Shows that this unit is in the automatic tuning mode.

7 MUTE indicator

Flashes while the MUTE function is on.

8 VOLUME level indicator

Indicates the volume level.

9 PCM indicator

Lights up when this unit is reproducing PCM (pulse code modulation) digital audio signals.

10 SILENT indicator

Lights up when headphones are connected and the digital sound field processor is on.

11 Multi-information display

Shows the current DSP program name and other information when you are adjusting or changing settings.

12 NIGHT indicator

Lights up when the unit is set to night listening mode.

13 HiFi DSP indicator

Lights up when you select a Hi-Fi DSP sound field program.

14 CINEMA DSP indicator

Lights up when you select a CINEMA DSP sound field program.

15 STEREO indicator

Lights up when the unit is receiving a strong signal from a FM stereo broadcast while the "AUTO" indicator is lit.

16 TUNED indicator

Lights up when this unit is tuned to a radio station.

17 MEMORY indicator

Flashes to show a station can be stored in memory.

18 SLEEP indicator

Lights up while the sleep timer is on.

19 LFE indicator

Lights up when the input signal contains an LFE signal.

20 Input channel indicator

The indicators for the appropriate sound channels light up when a digital signal from a source is played back.

21 RDS indicator (U.K. and Europe models only)

The name(s) of the RDS data offered by the currently received RDS station light(s) up. EON indicator lights up when an RDS station that offers the EON data service is being received. PTY HOLD indicator lights up while searching for stations in the PTY SEEK mode.

CONNECTIONS

Before connecting components

CAUTION

Do not connect this unit or other components to the mains power until all connections between the components have been completed.

- Be sure all connections are made correctly, that is to say L (left) to L, R (right) to R, “+” to “+” and “-” to “-”. Some components require different connection methods and have different jack names. Refer to the operation instructions for each component you wish to connect to this unit.
- After you have completed all connections, check them again to make sure they are correct.
- The jack names correspond to the names on the input selector.

Connecting to digital jacks

This unit has digital jacks for direct transmission of digital signals through either a coaxial or fiber optic cable. You can use the digital jacks to input PCM, Dolby Digital and DTS bitstreams. Use digital connections if you wish to enjoy the multi-channel sound track of DVD material, etc. with DSP effects. Both digital input jacks are acceptable for 96 kHz sampling digital signals.

Note

- The OPTICAL jack on this unit conform to the EIA standard. If you use a fiber optic cable that does not conform to this standard this unit may not function properly.

DIGITAL INPUT jacks (pages 9 – 11)

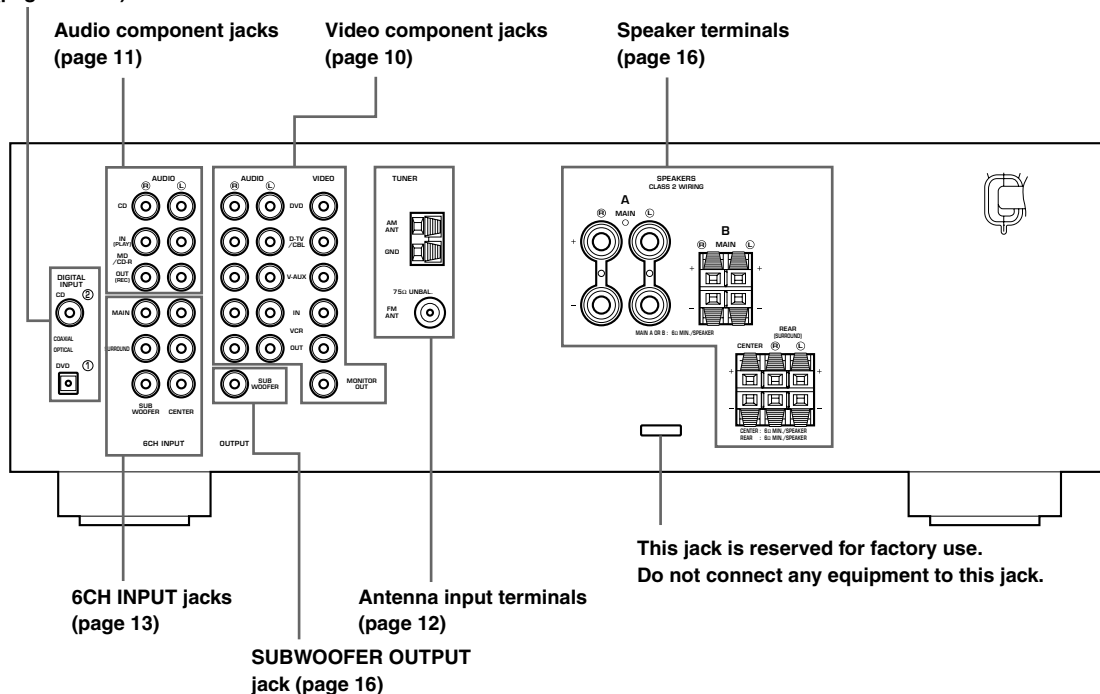

Connecting video components

■ Connecting a video monitor

Connect the video input jack on your video monitor to the MONITOR OUT VIDEO jack.

■ Connecting a DVD player

Connect the optical digital audio signal output jack on your component to the DIGITAL INPUT jack and connect the video signal output jack on the component to the VIDEO jack on this unit.



- Use the AUDIO jacks on this unit for a video component which does not have optical digital output jack. However, multi-channel reproduction cannot be obtained with audio signals input from the AUDIO jacks.

■ Connecting a digital TV/cable TV

Connect the video signal output jack on your component to the VIDEO jack on this unit. Connect the audio signal output jacks on the component to the AUDIO jacks on this unit.

■ Connecting another video component

Connect the video signal output jack on your component to the VIDEO jack on this unit. Connect the audio signal output jacks on the component to the AUDIO jacks on this unit.

■ Connecting a recording component

Connect the audio signal input jacks on your video component to the AUDIO OUT jacks on this unit. Then connect the video signal input jack on the video component to the VIDEO OUT jack on this unit for picture recording.

Connect the audio signal output jacks on your component to the AUDIO IN jacks on this unit. Then connect the video signal output jack on the component to the VIDEO IN jack on this unit to play a source from your recording component.

Note

- Once you have connected a recording component to this unit, keep its power turned on while using this unit. If the power is off, this unit may distort the sound from other components.

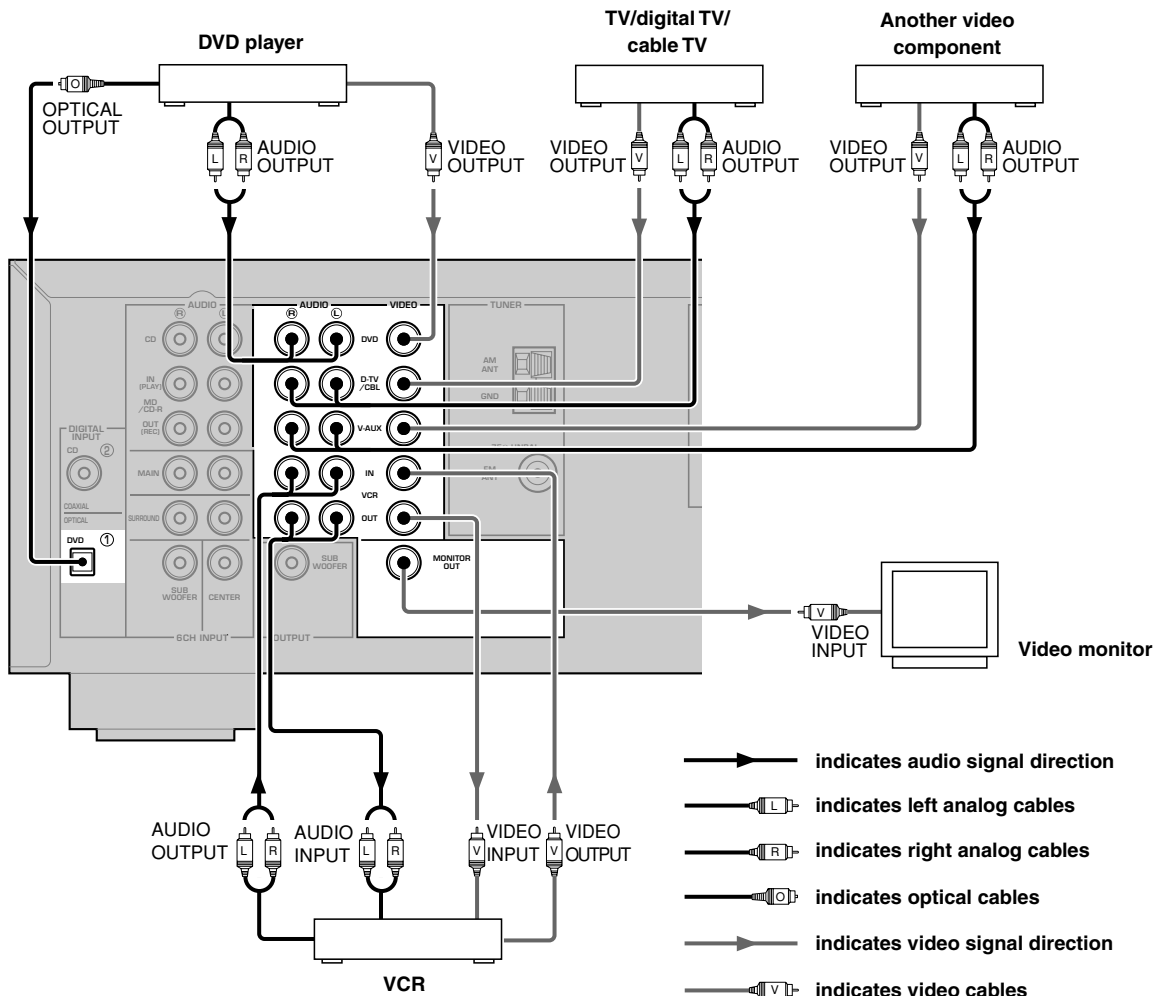

Connecting audio components

■ Connecting a CD player

Connect the coaxial digital output jack on your CD player to the DIGITAL INPUT CD jack on this unit.



- Use the AUDIO jacks on this unit to connect to a CD player that does not have a COAXIAL DIGITAL OUTPUT jack, or to record from CD players.

■ Connecting a CD recorder or MD recorder

Connect the input jacks on your CD recorder or MD recorder to the MD/CD-R OUT (REC) jacks.

Connect the output jacks on your CD recorder or MD recorder to the MD/CD-R IN (PLAY) jacks to play a source from your recording component.

Note

- Once you have connected a recording component to this unit, keep its power turned on while using this unit. If the power is off, this unit may distort the sound from other components.

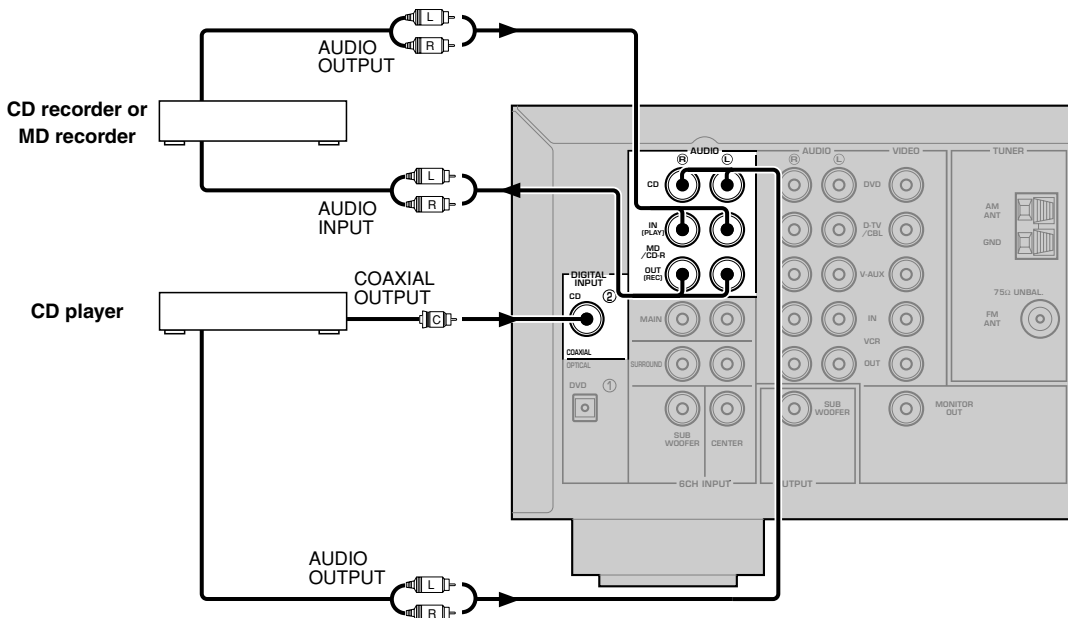

- indicates signal direction
- L— indicates left analog cables
- R— indicates right analog cables
- C— indicates coaxial cables

Connecting the antennas

Both AM and FM indoor antennas are included with this unit. In general, these antennas should provide sufficient signal strength.

Connect each antenna correctly to the designated terminals.

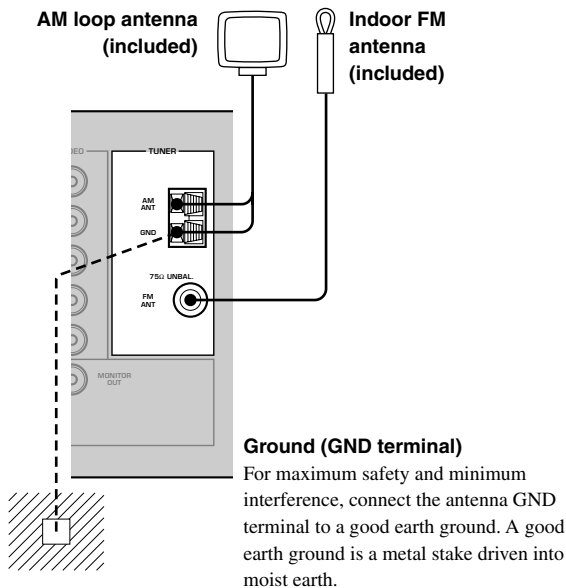

■ Connecting the AM loop antenna

1 Set up the AM loop antenna, then connect it to the terminals on this unit.

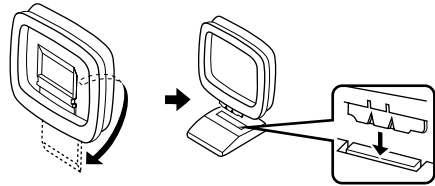

2 Press and hold the tab to insert the AM loop antenna lead wires into the AM ANT and GND terminals.

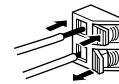

3 Orient the AM loop antenna for the best reception.



Notes

- The AM loop antenna should be placed away from this unit.
- The AM loop antenna should always be connected, even if an outdoor AM antenna is connected to this unit.

A properly installed outdoor antenna provides clearer reception than an indoor one. If you experience poor reception quality, an outdoor antenna may improve the quality. Consult the nearest authorized YAMAHA dealer or service center about the outdoor antennas.

FREQUENCY STEP switch (General model only)

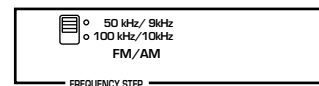

Because the inter-station frequency spacing differs in different areas, set the FREQUENCY STEP switch (located on the rear panel) according to the frequency spacing in your area.

North, Central and South America: 100 kHz/10 kHz
Other areas: 50 kHz/9 kHz

Before setting this switch, disconnect the AC power plug of this unit from the AC outlet.

Connecting an external decoder

This unit is equipped with 6 additional input jacks (MAIN left and right, CENTER, SURROUND left and right and SUBWOOFER) for discrete multi-channel input from a component equipped with a multi-channel decoder and 6 channel output jacks such as a DVD/SACD player.

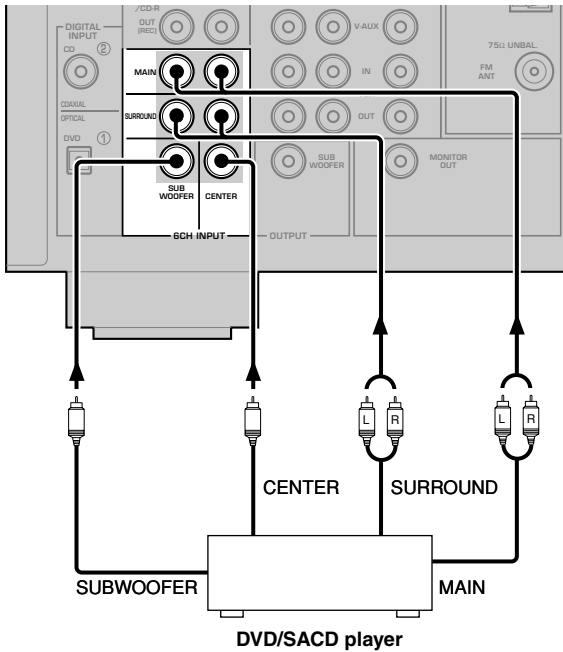

PREPARATION

Note

- When you select 6CH INPUT as the input source, the unit automatically turns off the digital sound field processor, and you cannot use DSP programs.

English

Connecting the speakers

Speakers

This unit has been designed to provide the best sound-field quality with a 5-speaker system, using main left and right speakers, rear left and right speakers and a center speaker. If you use different brands of speakers (with different tonal qualities) in your system, the tone of a moving human voice and other types of sound may not shift smoothly. We recommend that you use speakers from the same manufacturer or speakers with the same tonal quality.

The main speakers are used for the main source sound plus effect sounds. They will probably be the speakers from your present stereo system. The rear speakers are used for effect and surround sounds. The center speaker is for the center sounds (dialog, vocals, etc.).

The main speakers should be high-performance models and have enough power-handling capacity to accept the maximum output of your audio system. The other speakers do not have to be equal to the main speakers. For precise sound localization, however, it is ideal to use the models of equivalent performance with the main speakers.

Use of a subwoofer expands your sound field

It is also possible to further expand your system with the addition of a subwoofer. The use of a subwoofer is effective not only for reinforcing bass frequencies from any or all channels, but also for reproducing the LFE (low-frequency effect) channel with high fidelity when playing back Dolby Digital or DTS signals. The YAMAHA Active Servo Processing Subwoofer System is ideal for natural and lively bass reproduction.

Speaker placement

Refer to the following diagram when you place the speakers.

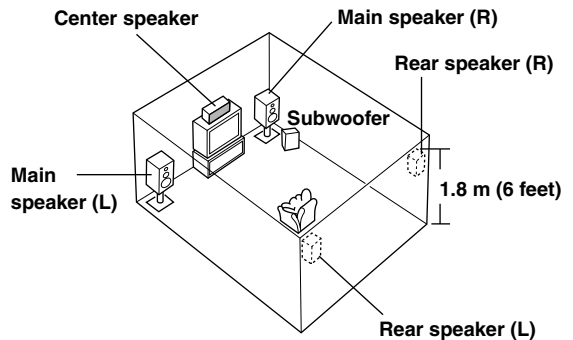

Main speakers

Place the main left and right speakers an equal distance from the ideal listening position. The distance between each speaker and each side of the video monitor should also be the same.

Center speaker

Align the front face of the center speaker with the front face of your video monitor. Place the speaker as close to the monitor as possible (such as directly over or under the monitor) and centrally between the main speakers.

Rear speakers

Place these speakers behind your listening position, facing slightly inwards, about 1.8 m (6 feet) above the floor.

Subwoofer

The position of the subwoofer is not so critical, because low bass sounds are not highly directional. However, it is better to place the subwoofer near the main speakers. Turn it slightly toward the center of the room to reduce wall reflections.

Note

- If you do not use any of effect speakers (rear and/or center), change the settings of "SOUND 1 SPEAKER SET" items at the set menu to direct signals to other terminals you have connected speakers to.

CAUTION

Use magnetically shielded speakers. If these speakers still create interference with the monitor, place the speakers away from the monitor.

■ Connections

Be sure to connect the left channel (L), right channel (R), “+” (red) and “-” (black) in accordance with the markers on this unit, the speakers, and the speaker cables. If the connections are faulty, no sound will be heard from the speakers, and if the polarity of the speaker connections is incorrect, the sound will be unnatural and lack bass.

CAUTION

- Use speakers with the specified impedance shown on the rear panel of this unit.
- Do not let the bare speaker wires touch each other or any metal part of this unit. This could damage this unit and/or the speakers.

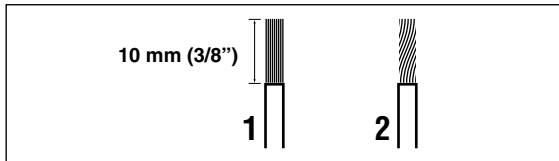

A speaker cord is actually a pair of insulated cables running side by side. One cable is colored or shaped differently, perhaps with a stripe, groove or ridge.

- 1** Remove approximately 10 mm (3/8”) of insulation from each of the speaker cables.
- 2** Twist the exposed wires of the cable together to prevent short circuits.

Connecting to the MAIN A SPEAKERS terminals

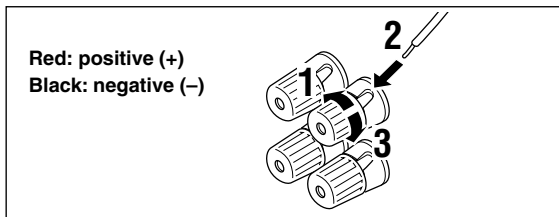

- 1** Unscrew the knob.
- 2** Insert one bare wire into the hole in the side of each terminal.
- 3** Tighten the knob to secure the wire.

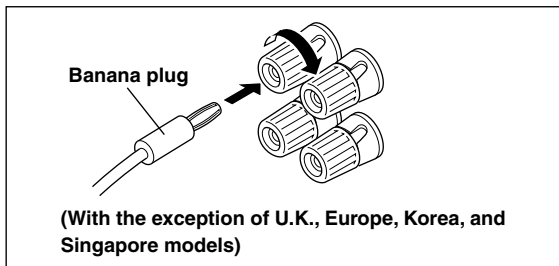

(With the exception of U.K., Europe, Korea, and Singapore models)

- You can also use banana plug connectors. First, tighten the knob and then insert the banana plug connector into the end of the corresponding terminal.

Connecting to the MAIN B, CENTER and REAR SPEAKERS terminals

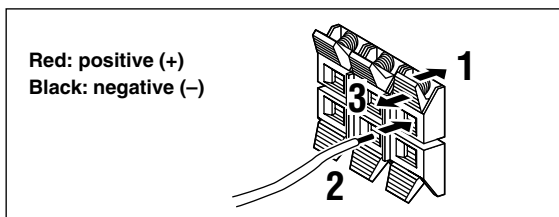

- 1** Press and open the tab.
- 2** Insert one bare wire into the hole of each terminal.
- 3** Release the tab to secure the wire.

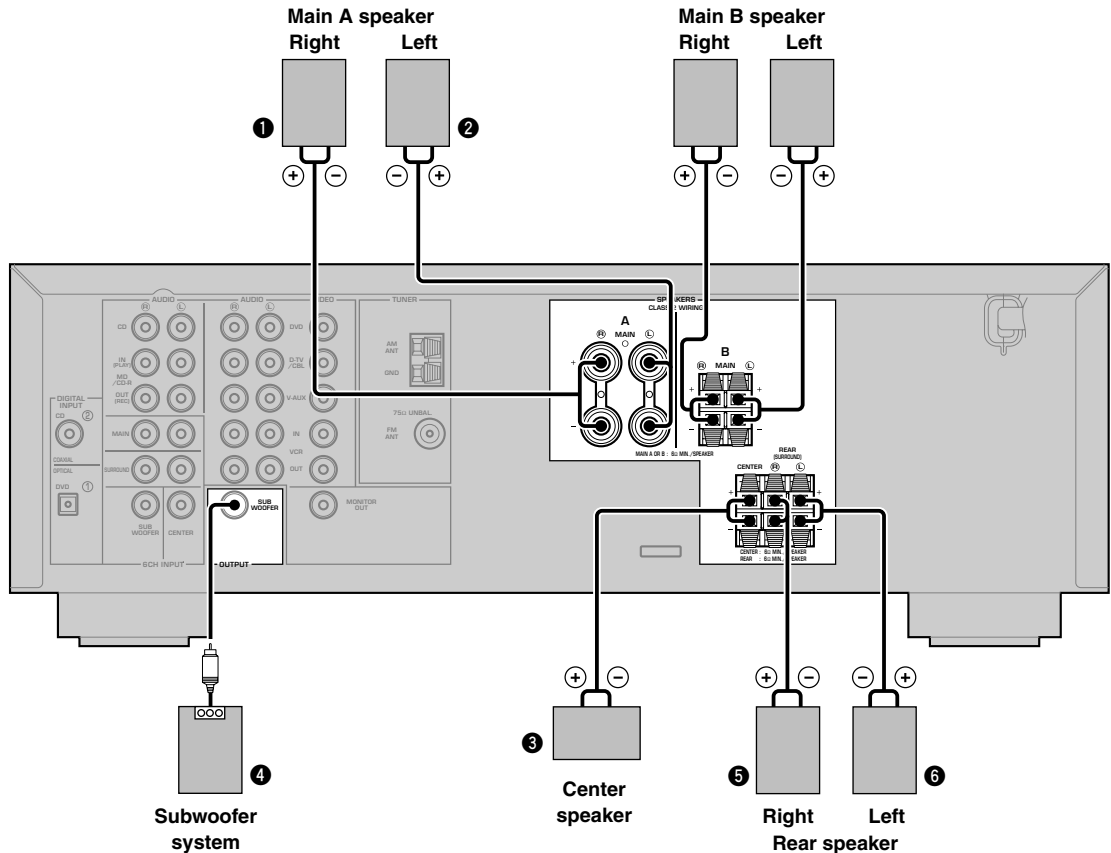

MAIN SPEAKERS terminals

You can connect up to two speaker systems to these terminals. When using only one speaker system, connect it to either of the MAIN A or the MAIN B terminals.

REAR SPEAKERS terminals

A rear speaker system can be connected to these terminals.

CENTER SPEAKER terminals

A center speaker can be connected to these terminals.

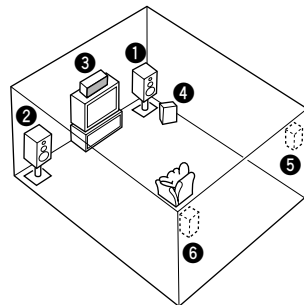

The diagram shows the speaker layout in the listening room.

SUBWOOFER jack

When using a subwoofer with built-in amplifier, including the YAMAHA Active Servo Processing Subwoofer System, connect the input jack of the subwoofer system to this jack. This unit will direct low bass signals distributed from the main, center and/or rear channels to this jack in accordance with your SPEAKER SET selections. The LFE (low-frequency effect) signals generated when Dolby Digital or DTS is decoded are also directed to this jack in accordance with your SPEAKER SET selections.

Notes

- The cut-off frequency of the SUBWOOFER jack is 90 Hz.
- If you do not use a subwoofer, allocate the signals to the main left and right speakers by changing the setting of "SOUND 1 SPEAKER SET" item "1D BASS" on the set menu to MAIN.
- Use the control on the subwoofer to adjust its volume level. You can also adjust the volume level by using this unit's remote control (see "SETTING THE SPEAKER LEVELS" on page 45).

Connecting the power supply cords

VOLTAGE SELECTOR

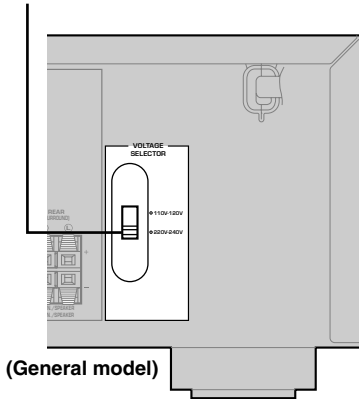

■ Connecting the AC power cord

Plug in this unit to a wall outlet.

■ VOLTAGE SELECTOR (General model only)

The VOLTAGE SELECTOR on the rear panel of this unit must be set for your local main voltage BEFORE plugging into the AC main supply. Voltages are 110V-120V/220V-240V AC, 50/60 Hz.

Turning on the power

When all connections are complete, turn on the power of this unit.

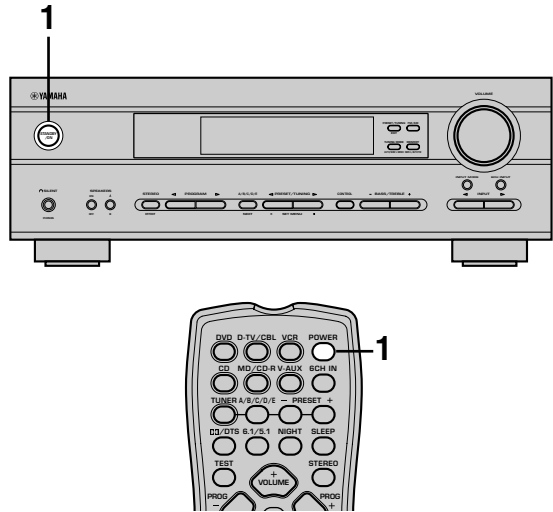

1 Press STANDBY/ON (POWER on the remote control) to turn on the power of this unit.



Front panel

or



Remote control

The level of the main volume, and then the current DSP program name appear on the front panel display.

BASIC SYSTEM SETTINGS

The "BASIC" menu allows you to set some of the basic "SOUND" menu parameters with a minimum of effort. If you wish to configure the unit more precisely to suit your listening environment, use the more detailed parameters from the "SOUND" menu instead of those under the "BASIC" menu (See page 40). Altering any parameters in the BASIC menu will reset all parameters in the "SOUND" menu.

Using the basic menu

Use the remote control to make adjustments.

- Press SPEAKERS A/B on the front panel to select the main speakers you want to use, and set SPEAKERS ON/OFF to the ON position.
- Make sure you disconnect headphones from this unit.

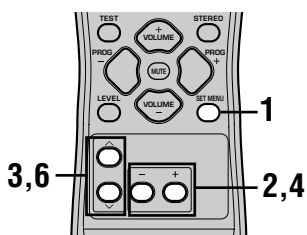

1 Press SET MENU.

"BASIC MENU" appears on the front panel display, as shown here.



If the front panel display changes to show anything other than "BASIC MENU", press \wedge until it displays "BASIC MENU".

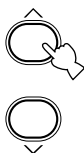

2 Press $-/+$ to enter into the BASIC menu.

The front panel display changes as shown here:



3 Press \wedge / \vee to change the display to the setting you want to alter.

SETUP

Changes the speaker and amplifier settings to suit the size of the room you are using. Refer to "Setting the unit to match your speaker system" on page 20 for more information.

SP LEVEL

Adjusts the output levels of the speakers.

Refer to "Setting speaker output levels" on page 20 for more information.

4 Press $-/+$ to enter the desired setting mode.

5 Change the unit settings to suit your listening environment. When you have finished, the unit will automatically return to the basic menu.

6 Press \wedge / \vee to exit from the set menu.

The front panel display changes in the following order:

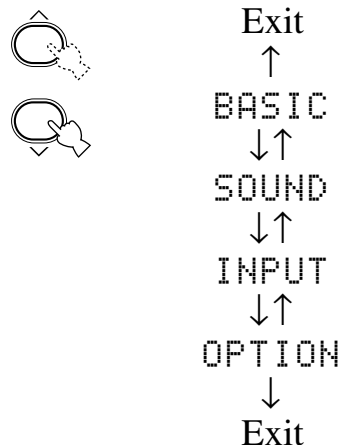

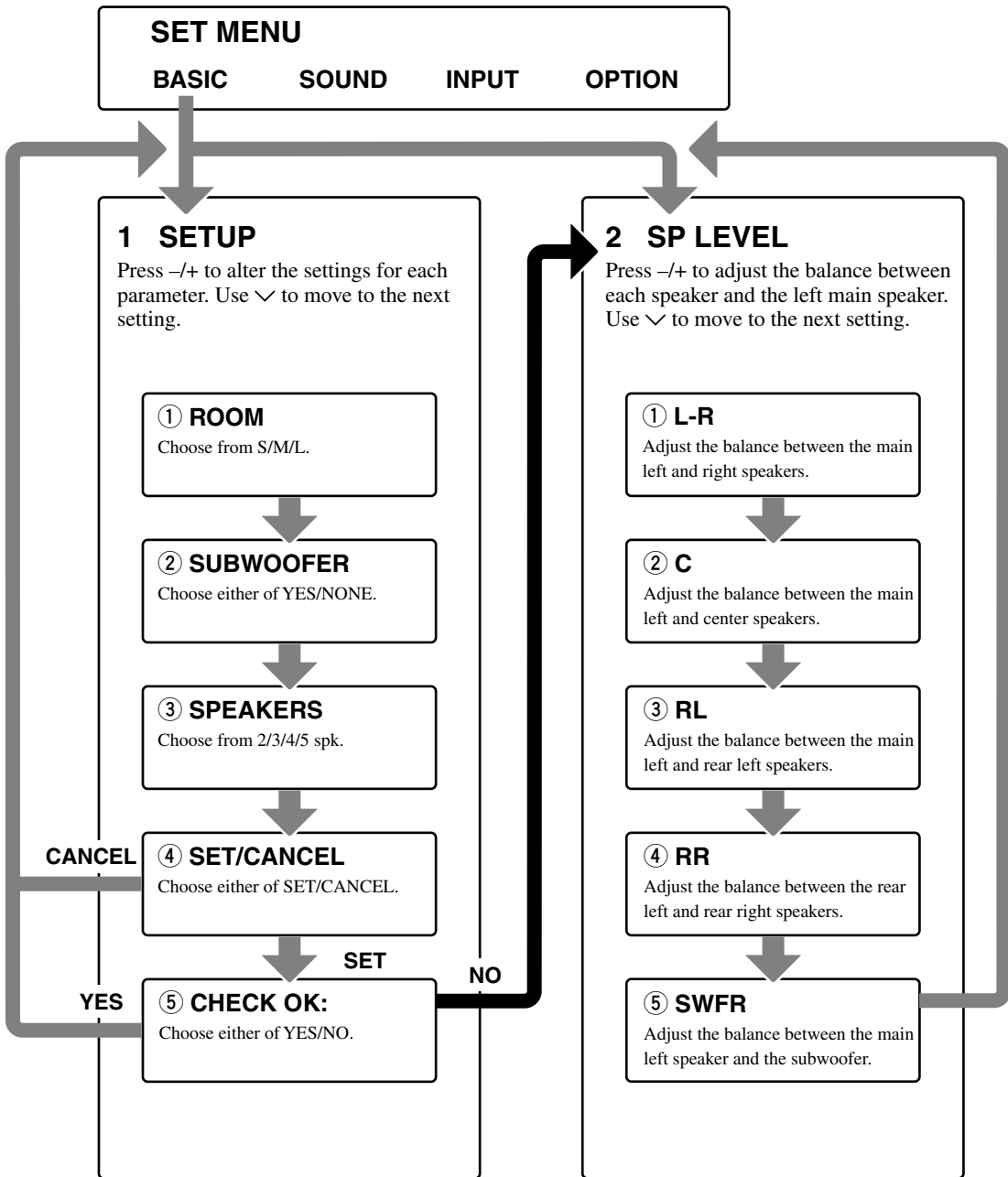

- After altering the “1 SETUP” parameters, readjust the output levels of the speakers at “2 SP LEVEL”.
- See pages 39 – 44 for a detailed explanation of the “SOUND”, “INPUT” and “OPTION” menus.

Setting the unit to match your speaker system

Follow the instructions below to set the amplifier output to match the size of your room and speakers. Press \wedge / \vee to cycle through parameters 1 through 4, and $-/+$ to alter the parameter setting.

Factory default settings are highlighted.

① ROOM

Settings: **S**, **M**, L

Select the size of the room you have installed your speakers in. Roughly speaking, the room sizes are defined as follows:

[U.S.A. and Canada models]

S: 16ft. x 3ft., 200sq.ft. (4.8 x 4m, 20m²)

M: 20ft. x 16ft., 300sq.ft. (6.3 x 5.0m, 30m²)

L: 26ft. x 19ft., 450sq.ft. (7.9 x 5.8m, 45m²)

[Other models]

S: 3.6m x 2.8m, 10m²

M: 4.8m x 4.0m, 20m²

L: 6.3m x 5.0m, 30m²

② SUBWOOFER

Settings: **YES**, NONE

Select YES if you have a subwoofer in your system, or NONE if you do not.

③ SPEAKERS

Settings: 2, 3, 4, **5** (spk)

Select the number of speakers you wish to use in your speaker configuration. This number does not include your subwoofer.

Setting	Display	Speaker
2spk	L R	Main L/Main R
3spk	L C R	Main L/Center/Main R
4spk	L R RL RR	Main L/Main R/Rear L/ Rear R
5spk	L C R RL RR	Main L/Center/Main R/ Rear L/Rear R

④ SET or CANCEL

Select SET to confirm the changes you made to the above three settings. The unit will output a test tone to the speakers (see ⑤). Alternatively, select CANCEL to exit this menu without altering any of the unit settings.

⑤ Use the test tone to check the speaker levels.

When you select SET in ④, the display changes to "CHECK: TestTone", and the unit outputs a test tone to each of the speakers in turn. When the test tone begins, the display changes to "CHECK OK?-- YES".

If the volume of the test tone varies between speakers, press $-/+$ to change the display to "NO". The unit will automatically enter the "2 SP LEVEL" mode.

If the test tone is output at the same volume from all of the speakers, select "CHECK OK: YES". Press \vee to exit from the SETUP menu.

Notes

- The unit cycles the test tone around each of the speakers in turn twice.
- The indicator of the speaker currently outputting the test tone flashes on the front panel display.

Setting speaker output levels (SP LEVEL)

Use this menu to compare and adjust the test tone output from each speaker to the output from the left main (or left rear) speaker so that the volume level for all speakers is identical. Press \wedge / \vee to select a speaker, then adjust the balance using $-/+$.

Note

- The unit outputs the test tone from the selected speaker and the left main (or left rear) speaker in turn. The indicator of the speaker currently outputting the test tone flashes on the front panel display.

① L-R

Adjusts the balance between the main left and right speakers.

② C

Adjusts the balance between the main left and center speakers.

③ RL

Adjusts the balance between the main left and rear left speakers.

④ RR

Adjusts the balance between the rear left and rear right speakers.

⑤ SWFR

Adjust the balance between the main left speaker and the subwoofer.

PLAYBACK

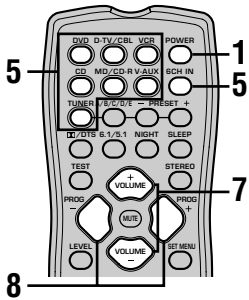
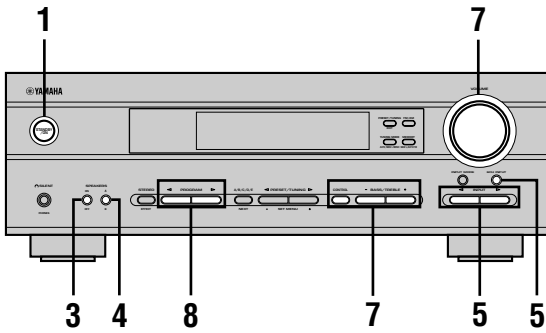

1 Press **STANDBY/ON** (**POWER** on the remote control) to turn on the power.

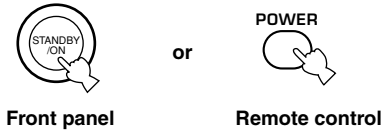

2 Turn on the video monitor connected to this unit.

3 Press and set **SPEAKERS ON/OFF** inward (**ON**).



4 Press and set **SPEAKERS A/B** inward (**A**) or outward (**B**) to select the main speakers you want to use.

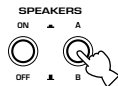

5 Press **INPUT** $\triangleleft/\triangleright$ repeatedly (one of the input selector buttons on the remote control) to select the input source.

The selected input source name and input mode appear on the front panel display for a few seconds.

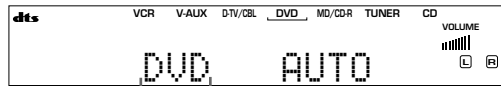
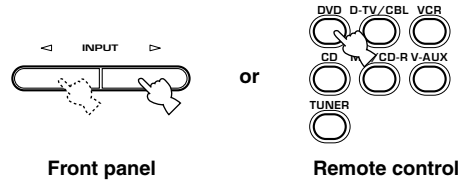

Selected input source

To select the audio source connected to the **6CH INPUT** jacks

- Select the input to which the video source component is connected before selecting an audio source. Press **6CH INPUT** until "6CH INPUT" appears on the front panel display.

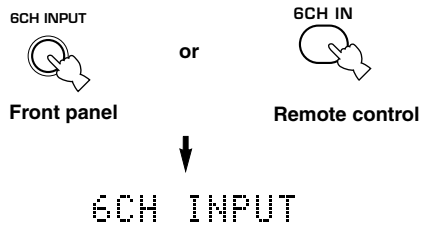

Note

- If "6CH INPUT" is shown on the front panel display, no other source can be played. To select another input source, first press **6CH INPUT** so that "6CH INPUT" disappears from the front panel display.

6 Start playback or select a broadcast station on the source component.

Refer to the operation instructions for the component.

7 Adjust the volume to the desired level.

The volume level is displayed digitally.

Example: -70 dB

Control range: VOLUME MUTE (minimum) to 0 dB (maximum)

The volume level indicator also shows the current volume level as a bar graph.

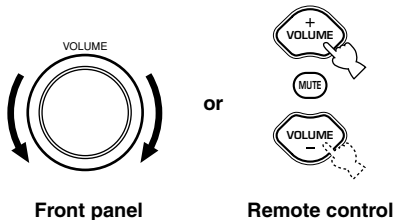

If desired, use CONTROL and BASS/TREBLE +/- . These controls only effect the sound from the main speakers.

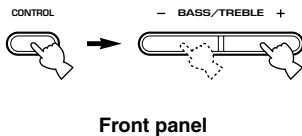

Front panel

Notes

- If you increase or decrease the high-frequency or the low-frequency sound to an extreme level, the tonal quality from the center and rear speakers may not match that of the main left and right speakers.
- If you have connected a recording component to the VCR OUT, or MD/CD-R OUT jacks, and you notice distortion or low volume during playback from other components, try turning the recording component on.

8 Select a DSP program if desired.

Use PROGRAM </> (PROG +/- on the remote control) to select a DSP program. See pages 27 – 30 for details about DSP programs.

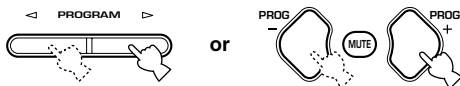

Front panel

Remote control

■ BGV (background video) function

The BGV function allows you to view images from a video source together with sounds from an audio source. For example, you can enjoy listening to classical music while watching beautiful scenery from a video source on the video monitor.

Select a source from the video group, then select a source from the audio group using the input selector buttons on the remote control.

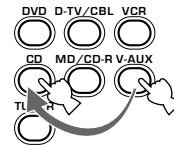

■ To mute the sound

Press MUTE on the remote control.

To resume audio output, press MUTE again.



- You can change the amount by which the unit reduces the volume in “OPTION 3 AUDIO MUTE” in the set menu.
- You can also cancel mute by pressing VOLUME +/-, etc.
- During muting, the MUTE indicator flashes on the front panel display.

■ Night listening mode

This mode reproduces dialogue clearly while reducing the volume of loud sound effects for easier listening at low volumes or at night.

Press NIGHT on the remote control.

Press NIGHT once more to return to normal reproduction.



Note

- Setting the unit in standby mode cancels night listening mode.
- You can use night listening mode with any of the sound field programs.
- The NIGHT indicator on the front panel display lights when the unit is in night listening mode.
- Night listening mode may vary in effectiveness depending on the input source and surround sound settings you use.

■ When you have finished using this unit

Press STANDBY/ON (POWER on the remote control) to set this unit in standby mode.



Front panel

or



Remote control

Input modes and indications

This unit is equipped with 2 types of input jacks for the CD and DVD sources only. You can select the type of input signals you wish to use.

Each time you turn on the unit power, the input mode is set to the "INPUT 2 INPUT MODE" setting defined in the set menu.

Press INPUT MODE repeatedly until the desired input mode is shown on the front panel display.

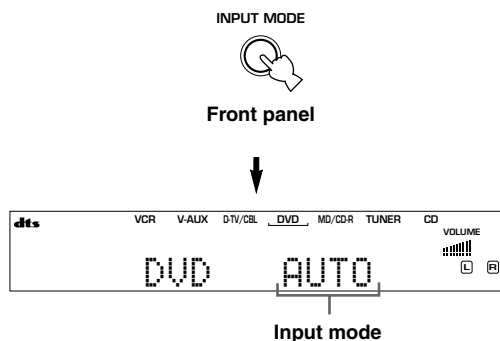

AUTO: In this mode, the input signal is selected automatically as follows:

- 1) Digital signal
- 2) Analog signal

DTS: In this mode, only digital input signals encoded with DTS are selected, even if the unit is receiving another signal simultaneously.

ANALOG: In this mode, only analog input signals are selected, even the unit is receiving digital signals at the same time.

Notes

- When AUTO is selected, this unit automatically determines the type of signal. If it detects a Dolby Digital or DTS signal, the decoder automatically switches to the appropriate setting.
- When playing a disc encoded with Dolby Digital or DTS on some LD or DVD players, there is a delay in sound output for a moment when playback resumes after a search, because the unit must select the digital signal again.
- When playing a LD source that has not been digitally recorded, the unit may not output any sound for some LD players. In this case, set the input mode to ANALOG.

Notes on digital signals

The digital input jacks of this unit can handle 96 kHz sampling digital signals. Note the following when a digital signal with a sampling frequency greater than 48 kHz is input to this unit:

- You cannot use any DSP programs.
- The unit will output sound as 2-channel stereo from the main left and right speakers only. Therefore, you cannot adjust the level of the effect speakers while listening to such a source.

Notes on playing DTS-CD/LDs

- If the digital output data of the player has been processed in any way, the unit may not be able to perform DTS decoding even if there is a digital connection between this unit and the player.
- If you play a source encoded with a DTS signal and set the input mode to ANALOG, the unit may reproduce the noise of an unprocessed DTS signal. In this case, connect the source to a digital input jack on this unit and set the input mode to AUTO or DTS.
- If you switch the input mode to ANALOG while playing a source encoded with a DTS signal, the unit does not output any sound.
- If you play a source encoded with a DTS signal with the input mode set to AUTO;
 - The unit automatically switches to the DTS-decoding mode (The "dts" indicator lights up) after detecting the DTS signal. When playback of the DTS source is completed, the "dts" indicator may flash. While this indicator is flashing, the unit can only reproduce DTS source. If you want to play a normal PCM source immediately, change the input mode back to AUTO.
 - When the input mode is set to AUTO and a search or skip operation is performed during playback of a DTS source, the "dts" indicator may flash. If this state continues for longer than 30 seconds, the unit will automatically switch from "DTS-decoding" mode to PCM digital signal input mode. The "dts" indicator will turn off.

Selecting a sound field program

You can enhance your listening experience by selecting a DSP program. For details about each program, see pages 27 – 30.

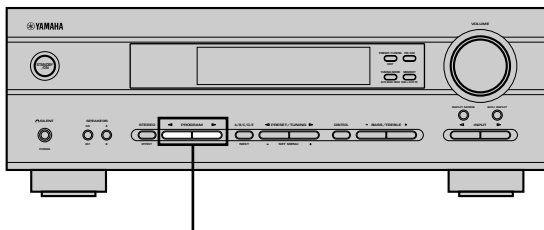

PROGRAM </>

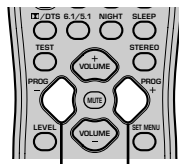

PROG +/-

Press **PROGRAM </>** (**PROG +/-** on the remote control) repeatedly to select the desired program (including sub-programs if available).

The name of the selected program (or sub-program) appears on the front panel display.

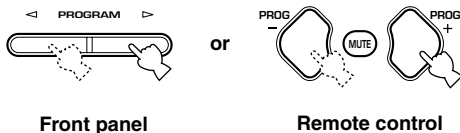

Front panel

Remote control

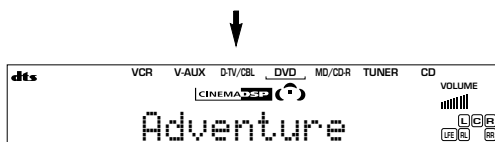

Program No. 7, 8 and 9 have two sub-programs respectively. Refer to page 29 for details.

Notes

- There are 9 programs with sub-programs available with this unit. However, the selection depends on the input signal format and not all sub-programs can be used with all input signal formats.
- You cannot use the digital sound field processor with a source connected to the 6CH INPUT jacks of this unit or when the unit is reproducing a digital source with a sampling frequency greater than 48 kHz.
- The acoustics of your listening room affect the DSP program. Minimize the sound reflections in your room to maximize the effect created by the program.
- When you select an input source, this unit automatically selects the last DSP program used with that source.
- When you set this unit in standby mode, it stores the current source and DSP program in memory and automatically selects them when you turn on the power again.
- If the unit receives a Dolby Digital or DTS signal when the input mode is set to AUTO, the DSP program (No. 7–9) automatically switches to the appropriate decoding program.
- When the unit is reproducing a monaural source with PRO LOGIC or PRO LOGIC/Enhanced, or PRO LOGIC II Movie, no sound is output from the main and rear speakers. Sound can only be heard from the center speaker. (If "1A CENTER" on the set menu is set to NON, the center channel sound is output from the main speakers.)



- Select a program based on your listening preference. Program names are just for reference.

■ Selecting PRO LOGIC or PRO LOGIC II

You can listen to 2-channel sources decoded into five discrete channels by selecting PRO LOGIC or PRO LOGIC II in program No. 9.

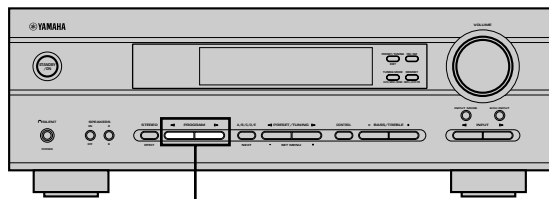

PROGRAM </>

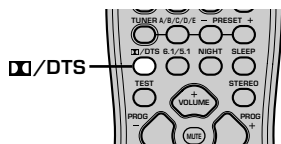

1 Select a 2-channel source and start playback on the source component.

2 Press **DD/DTS**.

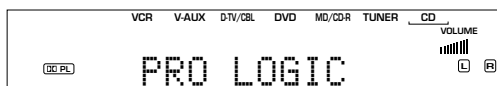

The display cycles as follows each time you press **DD/DTS**:
 PRO LOGIC → PRO LOGIC Enhanced → PRO LOGIC II
 Movie → PRO LOGIC II Music → PRO LOGIC →



- You can select PRO LOGIC, PRO LOGIC Enhanced, PRO LOGIC II Movie, and PRO LOGIC II Music by pressing PROGRAM </> on the front panel repeatedly.

■ Playing Dolby Digital EX or DTS ES material

Press 6.1/5.1 to turn on the Dolby Digital + Matrix 6.1 or DTS + Matrix 6.1 decoder.



(Example)



The display changes AUTO → Matrix6.1 → OFF each time 6.1/5.1 is pressed.

AUTO: This mode automatically switches Dolby Digital + Matrix 6.1 and DTS + Matrix 6.1 depending on the signal. Virtual rear center speaker does not work for 5.1 channel sources.

Matrix 6.1: This setting produces 6-channel playback of the input source using the Matrix 6.1 decoder. The virtual rear center speaker can be used when playing a 5.1-channel source.

OFF: Virtual rear center speaker does not work in this setting.

Notes

- Some 6.1-channel compatible discs do not have a signal (flag) that this unit can automatically detect. Select "Matrix 6.1" to play these kinds of discs with 6.1-channel sound.
- 6.1-channel playback is not possible even if you press 6.1/5.1 in the following cases:
 - When effects are turned off.
 - When the source connected to the 6CH INPUT jacks is being played.
 - When the unit is reproducing a Dolby Digital KARAOKE source.
 - When headphones are connected to the PHONES jack.
- The input mode resets to AUTO when you turn the unit power off.

■ Virtual CINEMA DSP

With Virtual CINEMA DSP, you can enjoy all DSP programs without rear speakers. It creates virtual speakers to reproduce a natural sound field.

You can listen to virtual CINEMA DSP by setting “1C REAR LR” in the set menu to NON. Sound field processing changes to VIRTUAL CINEMA DSP automatically.

Note

- This unit is not set in the virtual CINEMA DSP mode even if “1C REAR LR” is set to NON in the following cases:
 - when the 5ch Stereo, DOLBY DIGITAL, Pro Logic, Pro Logic II, or DTS program is selected;
 - when the sound effect is turned off;
 - when 6CH INPUT is selected as the input source;
 - when a digital signal with a sampling frequency greater than 48 kHz is input to this unit;
 - when using the test tone; or
 - when connecting the headphones.

■ SILENT CINEMA DSP

You can enjoy a powerful sound field similar to what you could expect from actual speakers through headphones, with SILENT CINEMA DSP. You can listen to SILENT CINEMA DSP by connecting your headphones to the PHONES jack while the digital sound field processor is on. The “SILENT” indicator lights up on the front panel display. (When sound effects are off, the unit reproduces the source in normal stereo.)

To listen to sounds with headphones only, press SPEAKERS ON/OFF to turn off the output of all the speakers.

Notes

- This feature is not available when 6CH INPUT is selected or the unit is receiving a digital signal with a sampling frequency greater than 48 kHz.
- The sound from the LFE channel will be mixed and output from the headphones.

■ Normal stereo reproduction

Press STEREO to turn off the sound effect for normal stereo reproduction.

Press STEREO again to turn the sound effect back on.

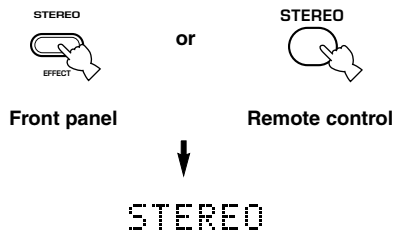

Notes

- If you turn off the sound effects, no sound is output from the center speaker or rear speakers.
- If you turn off the sound effects while the unit is reproducing sound from a Dolby Digital or DTS signal, the dynamic range of the signal is automatically compressed and the unit will mix the sounds of the center and rear speaker channels and output them from the main speakers.
- The volume may be greatly reduced when you turn off the sound effects or if you set “SOUND 4 D. RANGE (dynamic range)” on the set menu to MIN. In this case turn on the sound effect.



- During stereo reproduction, you can display information such as the type, format and sampling frequency of the signal input from the components connected to this unit.

(While playing a source)

- 1 Press \sphericalangle to display the information about the input signal.**

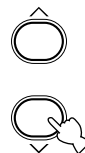

- (Format): The display shows the signal format. When the unit cannot detect a digital signal it automatically switches to analog input.
- in: The display shows the number of input signal source channels, as follows: For multi-channel soundtrack such as front 3 channels, rear 2 channels and LFE, the display shows “3/2/LFE”.
- fs: The display shows the sampling frequency. When the unit is unable to detect the sampling frequency “Unknown” shows in the front panel display.
- rate: The display shows the bit rate. When the unit is unable to detect the bit rate “Unknown” shows in the front panel display.
- flg: The display shows the flag - data encoded in a DTS or Dolby Digital signal that causes this unit to automatically switch to the appropriate decoder for playback.

DIGITAL SOUND FIELD PROCESSING (DSP)

Understanding sound fields

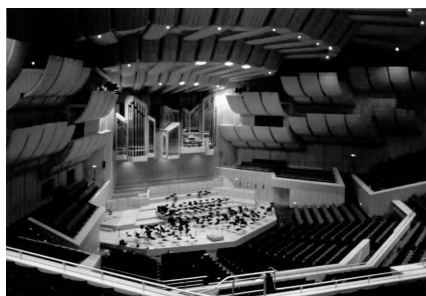

A sound field is defined as the “characteristic sound reflections of a particular space.” In concert halls and other music venues, we hear early reflections and reverberations as well as the direct sound produced by the artist(s). The variations in the early reflections and other reverberations among the different music venues is what gives each venue its special and recognizable sound quality.

YAMAHA sent teams of sound engineers all around the world to measure the sound reflections of famous concert halls and music venues, and collect detailed sound field information such as the direction, strength, range, and delay time of those reflections. Then we stored this enormous amount of data in the ROM chips of this unit.

■ Recreating a sound field

Recreating the sound field of a concert hall or an opera house requires localizing the virtual sound sources in your listening room. The traditional stereo system that uses only two speakers is not capable of recreating a realistic sound field. YAMAHA's DSP requires four effect speakers to recreate sound fields based on the measured sound field data. The processor controls the strength and delay time of the signals output from the four effect speakers to localize the virtual sound sources and fully encompass the listener.

Hi-Fi DSP programs

The following list gives you a brief description of the sound fields produced by each of the DSP programs. Keep in mind that most of these are precise digital recreations of actual acoustic environments.

No.	Program	Features
1	CONCERT HALL	A large round concert hall with a rich surround effect. Pronounced reflections from all directions emphasize the extension of sounds. The sound field has a great deal of presence, and your virtual seat is near the center, close to the stage.
2	JAZZ CLUB	This is the sound field at stage front in “The Bottom Line”, a famous New York jazz club, that seats up to 300 people. Its wide left to right seating arrangement offers a real and vibrant sound.
3	ROCK CONCERT	The ideal program for lively, dynamic rock music. The data for this program was recorded at LA's “hottest” rock club. The listener's virtual seat is at the center-left of the hall.
4	ENTERTAINMENT/ Disco	This program recreates the acoustic environment of a lively disco in the heart of a big city. The sound is dense and highly concentrated. It is also characterized by a high-energy, “immediate” sound.
	ENTERTAINMENT/ 5ch Stereo	Using this program increases the listening position range. This is a sound field suitable for background music at parties, etc.

CINEMA-DSP

Sound design of CINEMA-DSP

Filmmakers intend for the dialog to be located right on the screen, the effect sound a little farther back, the music spread even farther back, and the surround sound around the listener. Of course, all of these sounds must be synchronized with the images on the screen.

CINEMA-DSP is an upgraded version of YAMAHA DSP specially designed for movie soundtracks. CINEMA-DSP integrates the DTS, Dolby Digital, and Dolby Pro Logic surround sound technologies with YAMAHA DSP sound field programs to provide a surround sound field. It recreates comprehensive movie sound design in your audio room. In CINEMA-DSP sound field programs, YAMAHA's exclusive DSP processing is added to the Main left and right, and Center channels, so the listener can enjoy realistic dialogue, depth of sound, smooth transition between sound sources, and a surround sound field that goes beyond the screen.

When a DTS or Dolby Digital signal is detected, the CINEMA-DSP sound field processor automatically chooses the most suitable sound field program for that signal.

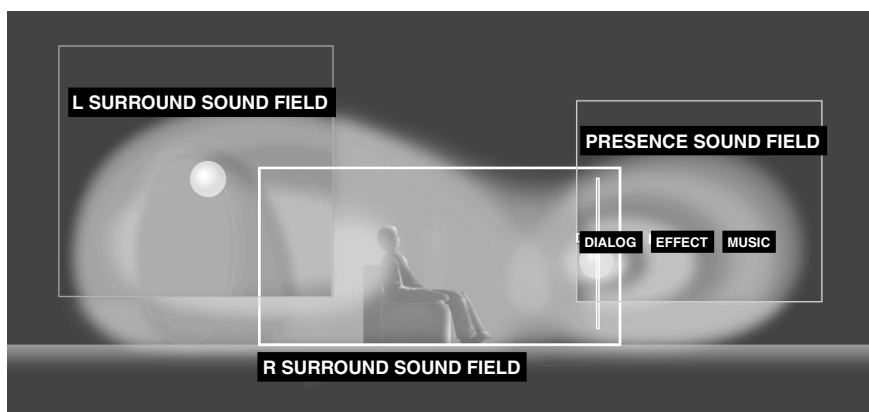

In addition to the DSP, this unit is equipped with a variety of precise decoders; Dolby Pro Logic decoder for Dolby Surround sources, Dolby Pro Logic II decoder for Dolby Surround and 2-channel sources, Dolby Digital/DTS decoder for multi-channel sources and Dolby Digital + Matrix 6.1 or DTS + Matrix 6.1 decoder for adding a rear center channel (the rear center channel is outputted from virtual rear center speaker). You can select CINEMA-DSP programs to optimize these decoders and the DSP sound patterns depending on the input source.

CINEMA-DSP Programs

The following list gives you a brief description of the sound fields produced by each of the DSP programs. Keep in mind that most of these are precise digital recreations of actual acoustic environments. Select the DSP program that you feel sounds best regardless of the name and description given for it below.

■ For audio-video sources: No. 4 to 6

No.	Program	Features
4	ENTERTAINMENT/ Game	This program adds a deep and spatial feeling to video game sounds.
5	MUSIC VIDEO	This program lends an enthusiastic atmosphere to the sound, giving you the feeling you are at an actual jazz or rock concert.
6	TV THEATER/ Mono Movie	This program is provided for reproducing monaural video sources (such as old movies). The program produces the optimum reverberation to create sound depth using only the presence sound field.
	TV THEATER/Variety/ Sports	Though the presence sound field is relatively narrow, the surround sound field employs the sound environment of a large concert hall. This effect enhances the experience of watching various TV programs such as news, variety shows, music programs or sports programs.

■ For movie programs

No.	Program		Features
7	MOVIE THEATER 1	Spectacle	This program creates the extremely wide sound field of a 70-mm movie theater. It precisely reproduces the source sound in detail, making both the video and the sound field incredibly real. This is ideal for any kind of video source encoded with Dolby Surround, Dolby Digital or DTS (especially large-scale movie productions).
		Sci-Fi	This program clearly reproduces dialog and sound effects in the latest sound form of science fiction films, thus creating a broad and expansive cinematic space amid the silence. You can enjoy science fiction films in a virtual-space sound field that includes Dolby Surround, Dolby Digital and DTS-encoded software employing the most advanced techniques.
8	MOVIE THEATER 2	Adventure	This program is ideal for precisely reproducing the sound design of the newest 70-mm and multichannel soundtrack films. The sound field is made to be similar to that of the newest movie theaters, so the reverberations of the sound field itself are restrained as much as possible.
		General	This program is for reproducing sounds from 70-mm and multichannel soundtrack films, and is characterized by a soft and extensive sound field. The presence sound field is relatively narrow. It spatially spreads all around and toward the screen, restraining the echo effect of conversations without losing clarity.
9	Straight Decode		The built-in decoder reproduces source sounds and sound-effects precisely. No DSP effect is applied in this program.
	Enhanced Mode		This program ideally simulates the multi-surround speaker systems of the 35-mm film theaters. Dolby Pro Logic decoding, Dolby Digital decoding or DTS decoding and digital sound field processing create precise effects without altering the original sound orientation. The surround effects produced by this sound field wrap around the viewer naturally from the back to the left and right, and toward the screen.

Straight Decode

This unit is equipped with various precise decoders;

- Dolby Digital/DTS decoder for multi-channel reproduction of the original sound
- Dolby Pro Logic/Pro Logic II decoder for multi-channel reproduction of 2-channel sources

Select any of the Straight Decode modes in Program 9 (except for the sub-program “Enhanced”) to use any of these decoders for reproducing the original sound without any sound effects added. In this case, no DSP effect is applied and the DSP indicator turns off.

Note

- When playing a monaural source with a CINEMA DSP program, the source signal is directed to the center channel, and the main and rear speakers output effect sounds.

Sound field effects

The 6-channel soundtracks found on 70-mm film produce precise sound field localization and rich, deep sound without using matrix processing. This unit's MOVIE THEATER programs provide the same quality of sound and sound localization that 6-channel soundtracks do. The built-in Dolby Digital or DTS decoder brings the professional-quality sound designed for movie theaters into your home. With this unit's MOVIE THEATER programs, you can use Dolby Digital or DTS technology to recreate a dynamic sound that gives you the feeling of being in a public theater.

■ Dolby Digital/DTS + DSP sound field effect

Presence DSP
sound field

Left surround DSP
sound field

Right surround DSP
sound field

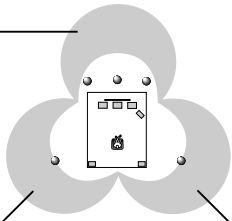

These programs use YAMAHA's tri-field DSP processing on each of the Dolby Digital or DTS signals for the front, left surround, and right surround channels. This processing enables this unit to reproduce the immense sound field and surround expression of a Dolby Digital- or DTS-equipped movie theater without sacrificing the clear separation of all channels.

■ Dolby Digital/DTS + Matrix 6.1 + DSP sound field effect

These programs provide you with the maximum experience of the spacious surround effects by adding an extra rear center DSP sound field created from the virtual rear center speaker.

■ Dolby Pro Logic + DSP sound field effect

Presence DSP
sound field

Surround DSP
sound field

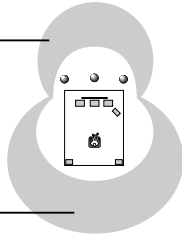

Most movie material has 4-channel (left, center, right, and surround) sound information encoded by Dolby Surround matrix processing and stored on the left and right tracks. These signals are processed by the Dolby Pro Logic decoder. The MOVIE THEATER programs are designed to recreate the spaciousness and delicate nuances of sound that tend to be lost in the encoding and decoding processes.

■ Dolby Pro Logic II

Dolby Pro Logic II decodes Dolby Surround software into 5 discrete full-range channels (3 channels in front and 2 channels in rear). There are 2 modes; MOVIE for movies and MUSIC for 2-channel audio sources.

TUNING

There are 2 methods of tuning; automatic and manual. Automatic tuning is effective when station signals are strong and there is no interference.

Automatic tuning

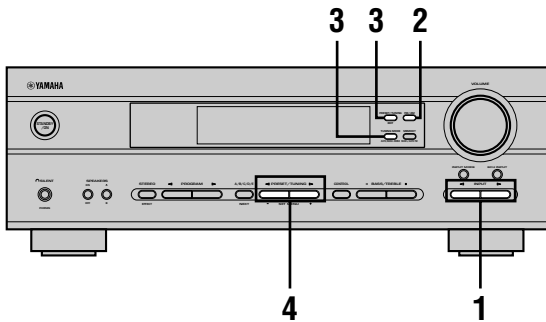

- 1 Press INPUT $\triangleleft/\triangleright$ (TUNER on the remote control) to select TUNER as the input source.

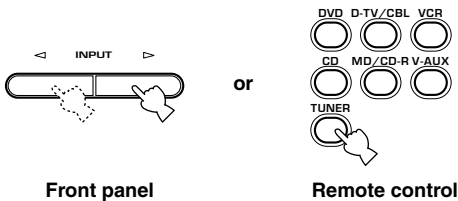

- 2 Press FM/AM to select the reception band. "FM" or "AM" appears on the front panel display.

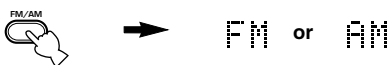

- 3 Press TUNING MODE (AUTO/MAN'L MONO) so that the "AUTO" indicator lights up on the front panel display.



If the colon (:) appears on the front panel display, press PRESET/TUNING (EDIT) to turn it off.

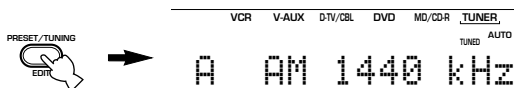

- 4 Press PRESET/TUNING $\triangleleft/\triangleright$ once to begin automatic tuning.

Press \triangleright to tune in to a higher frequency, or press \triangleleft to tune in to a lower frequency.

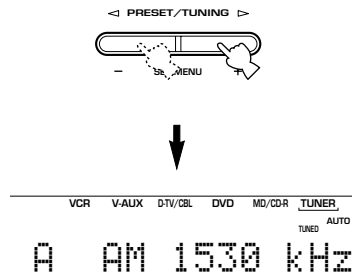

When the unit is tuned in to a station, the "TUNED" indicator lights up and the frequency of the station received is shown on the front panel display.

Manual tuning

If the signal from the station you are trying to select is weak, you must tune in to it manually.

- 1 Select TUNER and the reception band following steps 1 and 2 described in "Automatic tuning" at left.

- 2 Press TUNING MODE (AUTO/MAN'L MONO) until the "AUTO" indicator disappears from the front panel display.



If the colon (:) appears on the front panel display, press PRESET/TUNING (EDIT) to turn it off.

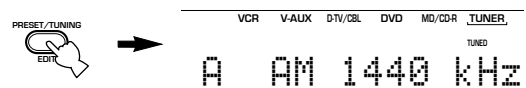

- 3 Press PRESET/TUNING $\triangleleft/\triangleright$ to tune in to the desired station manually.

Hold down the button to continue searching.

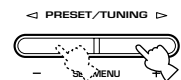

Note

- Manually tuning in to an FM station will automatically change the reception mode to monaural to increase the signal quality.

Presetting stations

■ Automatically presetting stations (for FM stations)

You can use the automatic preset tuning feature to store FM stations. This function enables the unit to automatically tune in to FM stations with strong signals, and to store up to 40 (8 stations x 5 groups) of those stations in order. You can then recall any preset station easily by selecting the preset number.

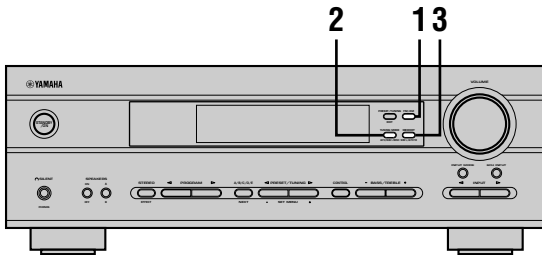

1 Press FM/AM to select the FM band.

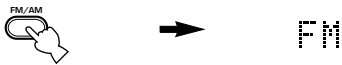

2 Press TUNING MODE (AUTO/MAN'L MONO) until the "AUTO" indicator lights up on the front panel display.



3 Press and hold MEMORY (MAN'L/AUTO FM) for at least 3 seconds.

The preset number and the "MEMORY" and "AUTO" indicators flash. After about 5 seconds, automatic preset tuning starts, beginning at the frequency currently displayed and moving toward the higher frequencies.

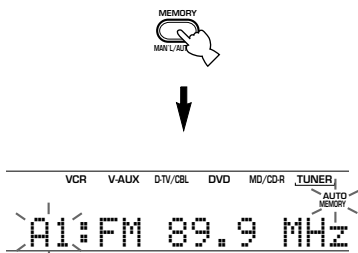

When automatic preset tuning is completed, the front panel display shows the frequency of the last preset station.

Notes

- Any stored station data existing under a preset number is cleared when you store a new station under that preset number.
- If the number of the received stations does not reach E8, automatic preset tuning has automatically stopped after searching all stations.
- Only FM stations with sufficient signal strength are stored automatically by automatic preset tuning. If the station you want to store is weak in signal strength, tune in to it manually in the monaural mode, and store it by following the procedure described in "Manually presetting stations" on page 33.

Automatic preset tuning options

You can select the preset number from which this unit will store FM stations and/or begin tuning toward lower frequencies. After pressing MEMORY in step 3:

1. Press A/B/C/D/E and PRESET/TUNING <1/> to select the preset number under which the first station will be stored. Automatic preset tuning will stop when stations have all been stored up to E8.
2. Press PRESET/TUNING (EDIT) to turn off the colon (:), and then press PRESET/TUNING <1/> to begin tuning toward lower frequencies.

Memory back-up

The memory back-up circuit prevents the stored data from being lost even if this unit is set in standby mode, the power cord is disconnected from the AC outlet, or the power supply is temporarily cut due to power failure. However, if the power is cut for more than one week, the preset stations may be cleared. If so, store the stations again.

Manually presetting stations

You can store up to 40 stations (8 stations x 5 groups) manually.

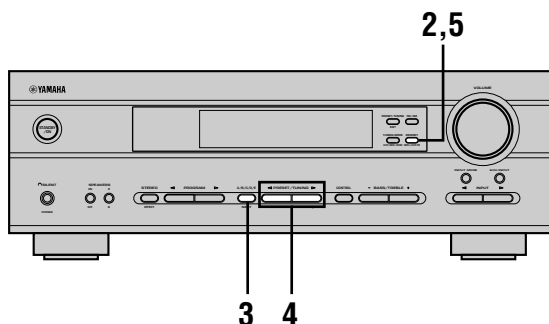

1 Tune in to a station.

See page 31 for tuning instructions.

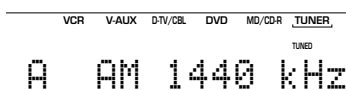

When tuned to a station, the front panel display shows the frequency of the station received.

2 Press MEMORY (MAN'L/AUTO FM).

The "MEMORY" indicator flashes for about 5 seconds.

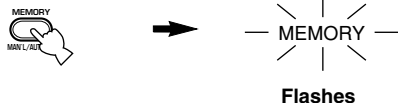

3 Press A/B/C/D/E repeatedly to select a preset station group (A to E) while the "MEMORY" indicator is flashing.

The group letter appears. Check that the colon (:) is showing on the front panel display.

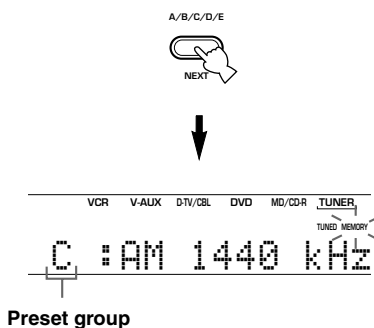

Preset group

4 Press PRESET/TUNING </> to select a preset station number (1 to 8) while the "MEMORY" indicator is flashing.

Press > to select a higher preset station number.
Press < to select a lower preset station number.

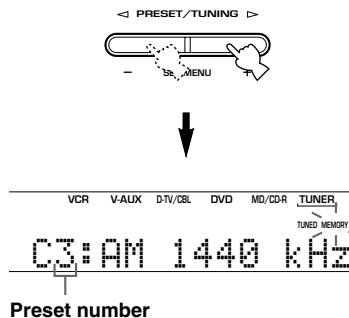

Preset number

5 Press MEMORY (MAN'L/AUTO FM) on the front panel while the "MEMORY" indicator is flashing.

The station band and frequency appear on the front panel display with the preset group and number you have selected.

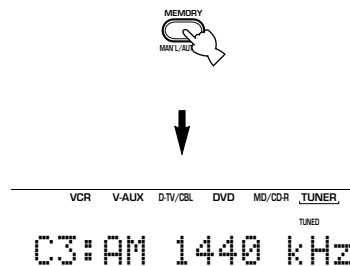

Shows the displayed station has been stored as C3.

6 Repeat steps 1 to 5 to store other stations.

Notes

- Any stored station data existing under a preset number is cleared when you store a new station under that preset number.
- The reception mode (stereo or monaural) is stored along with the station frequency.

Selecting a preset station

You can recall any desired station simply by selecting the preset station number under which it was stored.

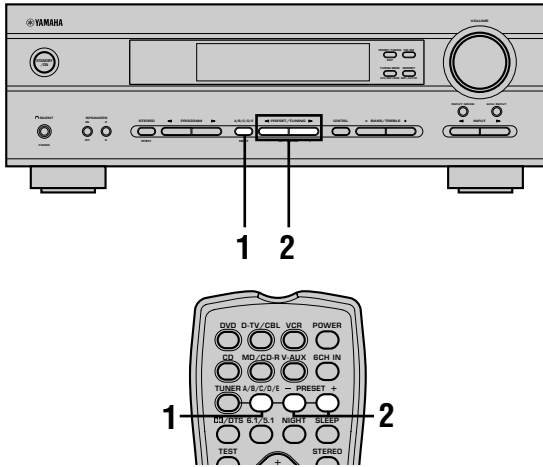

- 1 Press A/B/C/D/E (A/B/C/D/E on the remote control) to select the preset station group.** The preset group letter appears on the front panel display and changes each time you press A/B/C/D/E.



Front panel

or



Remote control

- 2 Press PRESET/TUNING </> (PRESET +/- on the remote control) to select a preset station number (1 to 8).**

The preset group and number appear on the front panel display along with the station band and frequency, and the "TUNED" indicator lights up.



Front panel

or

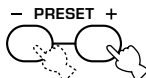

Remote control

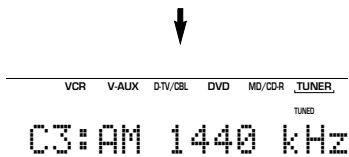

Exchanging preset stations

You can exchange the assignment of two preset stations. The example below describes the procedure for exchanging preset station "E1" with "A5".

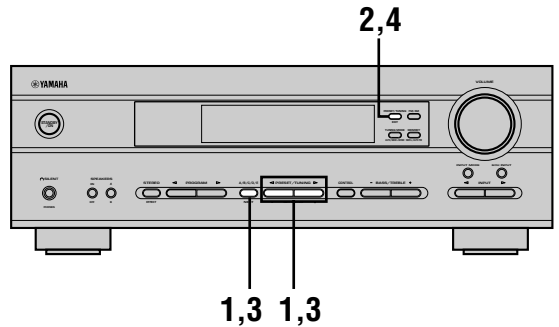

- 1 Select preset station "E1" by using the A/B/C/D/E and PRESET/TUNING </>.** See "Selecting a preset station" at left.

- 2 Press and hold PRESET/TUNING (EDIT) for at least 3 seconds.** "E1" and the "MEMORY" indicator flash on the front panel display.

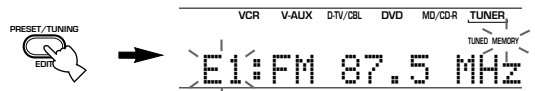

- 3 Select preset station "A5" by using the A/B/C/D/E and PRESET/TUNING </>.** "A5" and the "MEMORY" indicator flash on the front panel display.

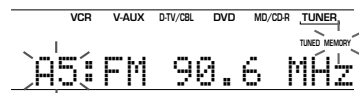

- 4 Press PRESET/TUNING (EDIT) again.** The stations stored at the two preset assignments are exchanged.

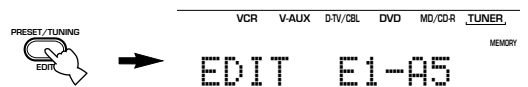

Shows the exchange of stations has been completed.

RECEIVING RDS STATIONS

RDS (Radio Data System) is a data transmission system used by FM stations in many countries.

RDS data contains a variety of information such as PS (Program Service name), PTY (Program Type), RT (Radio Text), CT (Clock Time), EON (Enhanced Other Networks), and others.

Description of RDS data

This unit can receive, PS, PTY, RT, CT, and EON data when tuned to stations broadcasting RDS.

■ PS (Program Service name) mode:

The name of the RDS station being received is displayed.

■ PTY (Program Type) mode:

There are 15 program types used to classify RDS stations.

NEWS	News
AFFAIRS	Current affairs
INFO	General information
SPORT	Sports
EDUCATE	Education
DRAMA	Drama
CULTURE	Culture
SCIENCE	Science
VARIED	Light entertainment
POP M	Pops
ROCK M	Rock
M.O.R. M	Middle-of-the-road music (easy-listening)
LIGHT M	Light classics
CLASSICS	Serious classics
OTHER M	Other music

■ RT (Radio Text) mode:

Information about the program (such as the title of the song, name of the singer, etc.) on the RDS station being received is displayed using a maximum of 64 alphanumeric characters, including the umlaut symbol. Any other characters used in RT data are displayed with under-bars.

■ CT (Clock Time) mode:

The current time is displayed and updated every minute. "CT WAIT" may appear if the data is accidentally cut off.

■ EON (Enhanced Other Networks):

Refer to the following page.

Changing the RDS mode

This unit provides four modes for displaying RDS data. The PS, PTY, RT and/or CT mode indicators that correspond to the RDS data services offered by the station light up on the front panel display when an RDS station is being received. Press RDS MODE/FREQ repeatedly to cycle the display through the RDS data offered by the transmitting station in the order shown below.

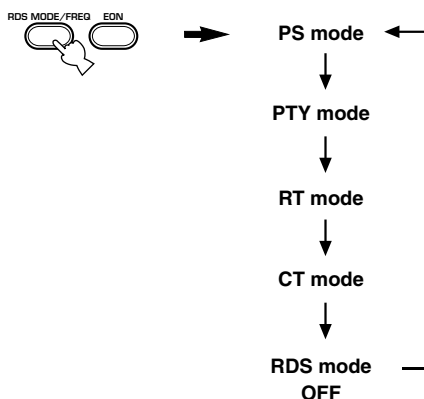

Notes

- Do not press RDS MODE/FREQ when an RDS station is being received until one or more RDS mode indicators light up on the front panel display. You cannot change the mode if you press this button prior to this. This is because this unit has not finished receiving all of the RDS data on the station.
- RDS data not offered by the station cannot be selected.
- This unit cannot utilize the RDS data service if the signal received is not strong enough. In particular, the RT mode requires a large amount of data, so it is possible that the RT mode may not be displayed even if other RDS modes (PS, PTY, etc.) are displayed.
- Sometimes, RDS data cannot be received in poor reception conditions. If this is the case, press TUNING MODE so that the "AUTO" indicator disappears from the front panel display. Although this will change the reception mode to monoaural, RDS data may be displayed when you change the display to RDS mode.
- If the signal strength is weakened by external interference during the reception of an RDS station, the RDS data service may cut off suddenly and "...WAIT" will appear on the front panel display.

PTY SEEK function

If you select the desired program type, the unit automatically searches all preset RDS stations that are broadcasting a program of the required type.

1 Press PTY SEEK MODE to set the unit in PTY SEEK mode.

The program type of the station the unit is currently receiving, or “NEWS” flashes on the front panel display.

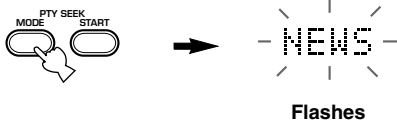

2 Press PRESET/TUNING </> to select the desired program type.

The selected program type appears on the front panel display.

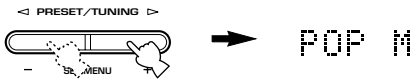

3 Press PTY SEEK START to begin searching all preset RDS stations.

The selected program type flashes and the “PTY HOLD” indicator lights up on the front panel display while the unit is searching for stations.

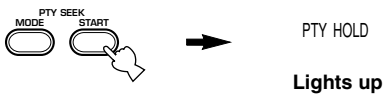

- The unit will stop searching if a station that is broadcasting a program of the required type is found.
- If the station found is not the desired one, press PTY SEEK START again. The unit begins searching for another station that is broadcasting a program of the same type.

■ To cancel this function

Press PTY SEEK MODE twice.

EON function

This function uses the EON data service on the RDS station network. If you select the desired program type (NEWS, INFO, AFFAIRS or SPORT), the unit automatically searches for all preset RDS stations that are scheduled to broadcast a program of the required type and switches from the station being currently received to the new station when the broadcasts starts.

Note

- This function can only be used when an RDS station that offers the EON data service is being received. When the unit is tuned to such a station, the “EON” indicator lights up on the front panel display.

1 Check that the “EON” indicator lights up on the front panel display.

If the “EON” indicator does not light up, tune in to another RDS station so that the “EON” indicator lights up.

2 Press EON repeatedly to select the desired program type (NEWS, INFO, AFFAIRS or SPORT).

The selected program type name appears on the front panel display.



- If a preset RDS station of the selected program type starts broadcasting, the unit will automatically switch from the program being currently received to that program. (EON indicator flashes.)
- When broadcasting of the required program ends, the unit returns to the previous station (or another program on the same station).

■ To cancel this function

Press EON repeatedly until the program type name disappears from the front panel display.

SLEEP TIMER

Use this feature to automatically set this unit in standby mode after the amount of time you have set. The sleep timer is useful when you are going to sleep while this unit is playing or recording a source.

The sleep timer can only be set with the remote control.



- By connecting a commercially available timer to this unit, you can also set a wake-up timer. Refer to the operation instructions of the timer.

Setting the sleep timer

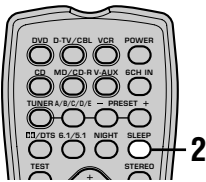

1 Select a source and start playback on the source component.

2 Press SLEEP repeatedly to set the amount of time.

Each time you press SLEEP, the front panel display changes as shown below.

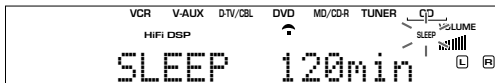
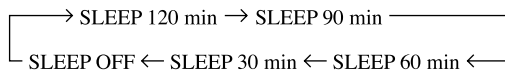

3 The "SLEEP" indicator lights up on the front panel display soon after the sleep timer has been set.

The display then returns to the previous indication.

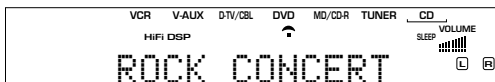

Canceling the sleep timer

Press SLEEP repeatedly until "SLEEP OFF" appears on the front panel display.

After a few seconds, "SLEEP OFF" disappears, the "SLEEP" indicator goes off and the display returns to the previous indication.

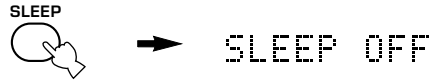

- The sleep timer setting can also be canceled by setting this unit in standby mode by using POWER on the remote control (or STANDBY/ON on the front panel) or by disconnecting the AC power cord from the AC outlet.

RECORDING

Recording adjustments and other operations are performed on other recording components. Refer to the operation instructions for these components for details on their operation .

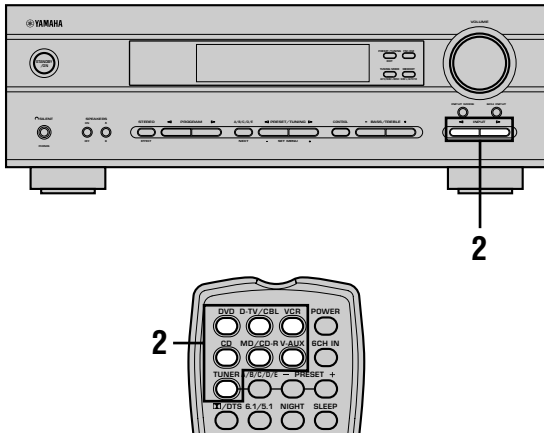

1 Turn on the power of this unit and all connected components.

2 Select the source component you want to record from.

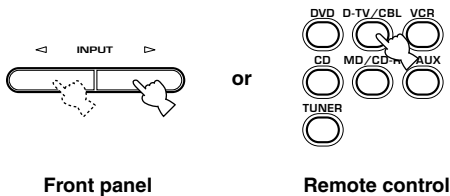

3 Start playback (or select a broadcast station) on the source component.

4 Start recording on the recording component.

Notes

- Do a test recording before you start an actual recording.
- When this unit is set in standby mode, you cannot record between the components connected to it.
- DSP programs and volume, bass, and treble settings do not affect the recorded material.
- You cannot record from a source connected to the 6CH INPUT jacks on this unit.
- Input sources are not output to the same OUT (REC) channel. (For example, the signal input from VCR IN is not output to VCR OUT.)
- You cannot record audio signals from a source connected to the DIGITAL INPUT jack on this unit because the signals from the DIGITAL INPUT jack and analog input jacks are independent. Please connect a source to the analog in jacks if you wish to record from the analog out jacks.
- Check the copyright laws in your country if you wish to record from records, CDs, radio, etc. Recording of copyrighted material may infringe copyright laws.

If you playback a video source that uses scrambled or encoded signals to prevent it from being dubbed, the picture itself may be disturbed due to those signals.

Special considerations when recording DTS material

The DTS signal is a digital bitstream. Attempting to digitally record the DTS bitstream will result in noise being recorded. Therefore, if you want to use this unit to record sources that have DTS signals recorded on them, the following considerations and adjustments need to be made.

For LDs, DVDs and CDs encoded with DTS, follow the operating instructions of your player to set it to output an analog signal, if it is compatible with the DTS format.

SET MENU

You can set the following parameters on the set menu to obtain a better sound from the unit. Change the settings to reflect the needs of your listening environment.

Set menu list

The set menus are divided by use and function into the 4 categories listed here.

■ BASIC

The BASIC area contains the basic parameters that you must set before using this unit. It consists of the following menus. See pages 18 – 20 for a detailed explanation.

1 SETUP

2 SP LEVEL (Speaker level)

■ SOUND

The SOUND area contains parameters for altering sound output. It consists of the following menus that you can use to alter the quality and tone of the sound output by the system.

1 SPEAKER SET

2 SP DISTANCE (Speaker distance)

3 LFE LEVEL (Low frequency effect level)

4 D. RANGE (Dynamic range)

5 CENTER GEQ (Center graphic equalizer)

6 HP TONE CTRL (Headphone tone control)

■ INPUT

The INPUT area contains parameters concerned with signal input. It consists of the following menus that you can use to change the assignment of input jacks.

1 I/O ASSIGN

2 INPUT MODE

■ OPTION

This is a supplementary set up menu provided for your convenience. It consists of the following menus that you can use to change display brightness, protect existing settings, and perform other non-essential functions.

1 DISPLAY SET

2 MEM. GUARD

3 AUDIO MUTE

- In the descriptions for each item from the following page, the default setting is indicated in bold.

Adjusting the items on the set menu

Use the remote control to make adjustments.

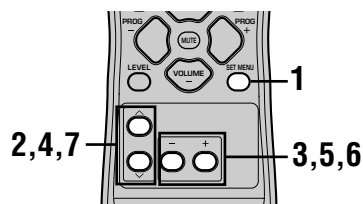

- You can change set menu parameters while the unit is reproducing sound.
- You can use NEXT and SET MENU +/- on the front panel to change these settings, if the unit is not set to TUNER mode. Press NEXT to select the category or field you wish to change, and SET MENU +/- to change the parameters.

Note

- You cannot change some set menu parameters while the unit is in night listening mode.

- 1 Press SET MENU to enter the set menu.



- 2 Press ^ / v repeatedly to select the desired menu.

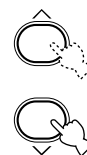

- 3 Press -/+ to enter the selected menu.



- 4 Press ^ / v repeatedly to select the item you want to adjust.

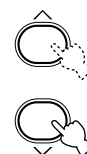

- By pressing SET MENU repeatedly, you can select items in the same order as when pressing v.

5 Press **-/+** once to enter the setup mode of the selected item.

The last setting you adjusted appears on the front panel display.

Depending on the menu item, press **^/∨** to select a sub item.

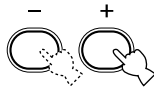

6 Press **-/+** repeatedly to change the menu item setting.

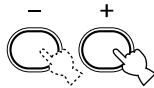

7 Press **^/∨** repeatedly until the menu disappears.



Memory back-up

The memory back-up circuit prevents the stored data from being lost even if this unit is in standby mode. However, if the power cord is disconnected from the AC outlet, or the power supply is cut for more than one week, the stored data will be lost. If this happens, adjust the items again.

The BASIC and SOUND menus

The "BASIC" menu allows you to easily set the "SOUND 1 SPEAKER SET" and "SOUND 2 SP DISTANCE" parameters. It is not necessary to reset any of the parameters in the "BASIC" menu, but you can access more detailed parameters in the "SOUND" menu if you wish.

Note

- After altering parameters in the "SOUND" menu, if you select "BASIC 1 SETUP" and then select "SET", the parameters from the "SOUND" menu alter in response to any changes you make in "BASIC 1 SETUP". Do not enter the "BASIC 1 SETUP" menu unless you wish to change these settings. If you accidentally enter the "BASIC 1 SETUP" menu, select CANCEL to return to the "BASIC" menu. (page 19)

SOUND 1 SPEAKER SET (speaker mode settings)

Use this feature to select suitable output modes for your speaker configuration.

Note

- Some menu item settings have no effect when the unit is reproducing a source with a digital signal sampling frequency greater than 48 kHz.

1A CENTER (center speaker mode)

If you add a center speaker to your speaker configuration, this unit can provide better dialog localization for several listeners and superior synchronization of sound and images.

Choices: LRG (large), SML (small), NON (none)

LRG

Select this if you have a large center speaker. The unit directs the entire range of the center channel signal to the center speaker.

SML

Select this if you have a small center speaker. The unit directs the low-frequency signals (90 Hz and below) of the center channel to the speakers selected with "1D BASS".

NON

Select this if you do not have a center speaker. The unit directs all of the center channel signal to the main left and right speakers.

■ 1B MAIN (main speaker mode)

Choices: **LARGE**, **SMALL**

LARGE

Select this if you have large main speakers. The unit directs the entire range of the main left and right channel signals to the main left and right speakers.

SMALL

Select this if you have small main speakers. The unit directs the low-frequency signals (90 Hz and below) of the main channel to the speakers selected with "1D BASS".

■ 1C REAR LR (rear speaker mode)

Choices: **LRG** (large), **SML** (small), **NON** (none)

LRG

Select this if you have large rear left and right speakers or if a rear subwoofer is connected to the rear speakers. The entire range of the rear channel signal is directed to the rear left and right speakers.

SML

Select this if you have small rear left and right speakers. The low-frequency signals (90 Hz and below) of the rear channel are directed to the speakers selected with "1D BASS".

NON

Select this if you do not have rear speakers.



- This unit is set in the virtual CINEMA DSP mode when you select **NON** for "1C REAR LR".

■ 1D BASS (bass out mode)

LFE signals carry low-frequency effects when this unit decodes a Dolby Digital or DTS signal. Low-frequency signals are defined as 90 Hz and below. The Low-frequency signals can be directed to both main left and right speakers, and to the subwoofer (subwoofer can be used for both stereo reproduction and the DSP program).

Choices: **SWFR** (subwoofer), **MAIN**, **BOTH**

SWFR

Select this if you use a subwoofer. The unit directs the LFE signals to the subwoofer.

MAIN

Select this if you do not use a subwoofer. The unit directs LFE signals to the main speakers.

BOTH

The unit directs LFE signals to the subwoofer. Low-frequency signals designated to the main channels in accordance with other speaker mode settings are directed to both main speakers and the subwoofer.

Note

- When you select **MAIN** for "1D BASS", the unit directs the low-frequency signals (90 Hz and below) of the main channel to the main speakers even if you select **SMALL** for the main speaker mode.

SOUND 2 SP DISTANCE (speaker distance)

Use this feature to adjust the delay applied to center channel sounds. This feature works when there is sound output from the center speakers with a source such as Dolby Digital or DTS. Ideally, the center speaker should be the same distance from the main listening position as the left and right main speakers. However, in most home situations, the center speaker is placed in line with the main speakers. By delaying the sound from the center speaker, you can adjust the apparent distance from the center speaker to the main listening position to make it seem the same as the distance between the listening position and main left and right speakers.

- 1** Press \wedge / \vee to select "UNIT".
- 2** Press $-/+$ to select the unit "meters" or "feet" to be used in setting.
- 3** Press \wedge / \vee to select the speaker for which you want to adjust the delay.
- 4** Press $-/+$ to set the delay.
Press + for higher values and – for lower values.

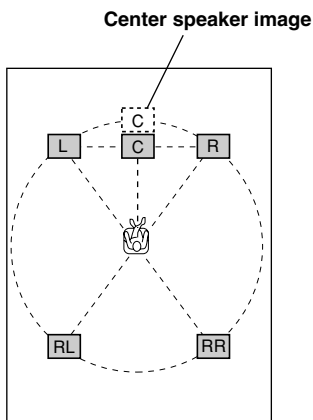

- Setting by "meters"**
 Control range: 0.3 to 24.00 m (for main L/R, center, rear L/R)
 Initial settings: 3.00 m (for main L/R, center, rear L/R)
- Setting by "feet"**
 Control range: 1 to 80 ft (for main L/R, center, rear L/R)
 Initial settings: 10.0 ft (for main L/R, center, rear L/R)

Note

- No delay will be set if you set the same distance for the main L/R, center and rear L/R.

SOUND 3 LFE LEVEL

Use this feature to adjust the output level of the LFE (low-frequency effect) channel when playing back a Dolby Digital or DTS signal. The LFE signal carries low-frequency special effect sound which is only added to certain scenes.

Control range:
 SPEAKER –20 to 0 dB
 HEADPHONE –20 to 0 dB
 Initial setting: 0 dB

- 1** Press \wedge / \vee to select the item to be adjusted.

- 2** Press – to adjust the LFE level.

Note

- Adjust the LFE level according to the capacity of your subwoofer or headphones.

SOUND 4 D. RANGE (dynamic range)

Use this feature to adjust the dynamic range. This setting is effective only when the unit is decoding Dolby Digital signals.

Choices: **MAX**, STD (standard), MIN (minimum)

MAX

Select MAX for feature films.

STD

Select STD for general use.

MIN

Select MIN for listening to sources at low volume levels.

SOUND 5 CENTER GEQ (center graphic equalizer)

Use this feature to adjust the built-in 5-band graphic equalizer so that the center speaker tonal quality matches that of the left and right main speakers. You can select the 100 Hz, 300 Hz, 1 kHz, 3 kHz, or 10 kHz frequencies.

Control range (dB): -6 to +6

Initial setting: 0 dB for 5-band

1 Press \vee to select a higher frequency and \wedge to select a lower frequency.

2 Press $-/+$ to adjust the level of that frequency.

Note

- You can monitor the center speaker sound while adjusting this parameter by using the test tone. Press TEST before starting the foregoing procedure. Once you begin this procedure, the test tone remains at the center speaker and you can hear how the sound changes as you adjust the various frequency levels. To stop the test tone, press TEST.

SOUND 6 HP TONE CTRL (headphone tone control)

Use this feature to adjust the level of the bass and treble when you are using headphones.

Control range (dB):

BASS -6 to +3

TRBL (treble) -6 to +3

Initial setting:

BASS 0 dB

TRBL 0 dB

INPUT 1 I/O ASSIGN (input/output assignment)

You can assign jacks according to the component to be used if this unit's DIGITAL INPUT jack settings (component names for jacks) differ from those of the component. This lets you to change the jack assignment and effectively connect more components.

Once assigned, select that component with INPUT $\triangleleft/\triangleright$ (or the input selector buttons on the remote control).

■ 1A for OPTICAL INPUT jack

Choices: (1) DVD, MD/CD-R, CD, VCR, V-AUX, D-TV/CBL

■ 1B for COAXIAL INPUT jack

Choices: (2) CD, VCR, V-AUX, D-TV/CBL, DVD, MD/CD-R

Note

- When you connect a component to both the COAXIAL and OPTICAL jacks, priority is given to the input signals from the COAXIAL jack.

INPUT 2 INPUT MODE (initial input mode)

Use this feature to designate the input mode for sources connected to the DIGITAL INPUT jacks when you turn this unit on (see page 23 for details about the input mode).

Choices: **AUTO**, **LAST**

AUTO

Select this setting to allow the unit to automatically detect the type of input signal and select the appropriate input mode.

LAST

Select this setting to set this unit to automatically select the last input mode used for the respective sources.

OPTION 1 DISPLAY SET

■ DIMMER

Use this to adjust the brightness of the front panel display.

Control range: -4 to 0

OPTION 2 MEM. GUARD (memory guard)

Use this feature to prevent accidental changes to settings on the unit.

Choices: ON, **OFF**

Select ON to protect the following features:

- All set menu items
- Main, center, rear speakers, and subwoofer levels
- DSP program parameters

Notes

- When this item is set to ON, you cannot use the test tone.
- When this item is set to ON, you cannot select any other set menu items.

OPTION 3 AUDIO MUTE

Adjusts the amount by which the MUTE function reduces the output volume.

Choices: **MUTE**, -50dB, -20dB

MUTE

Completely halts all output of sound.

-50dB

Reduces the volume of the present sound output by 50dB.

-20dB

Reduces the volume of the present sound output by 20dB.

SETTING THE SPEAKER LEVELS

Adjusting the volume during playback

You can adjust the volume of the speakers while listening to sound playback.

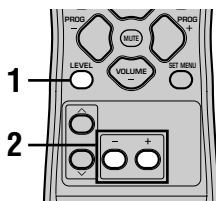

1 Press LEVEL repeatedly to select the speaker you want to adjust.

The unit cycles through the speakers in the following order each time you press LEVEL:
 MAIN L→CENTER→MAIN R→
 R SUR. (rear R)→L SUR. (rear L)→
 SWFR (subwoofer)→.....



- Pressing LEVEL once opens the level display. Press ^ / v at this time to select a speaker.

2 Press +/- to adjust the speaker volume.

- The center and rear speakers can be adjusted by a maximum of -10dB ~ +10dB.
- The main speakers and subwoofer can be adjusted by a maximum of -20dB ~ 0dB.

Notes

- You cannot adjust speaker levels if the "SOUND 1 SPEAKER SET" parameter in the set menu is set to NON.
- You cannot adjust the subwoofer level if the "ID BASS" parameter in "SOUND 1 SPEAKER SET" in the set menu is set to MAIN.
- If you use LEVEL to adjust speaker levels, the speaker levels you previously set with the test tone will also change.
- If you select "BASIC 1 SETUP" in the set menu and then select "SET", speaker levels change in response to any changes you make in "BASIC 1 SETUP".

Using the test tone

Use the test tone to set speaker levels so that the volume from each speaker is identical when heard from your listening position.

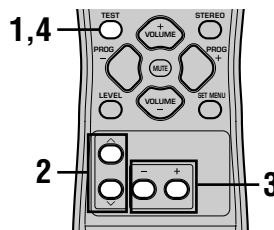

1 Press TEST.

The unit will output a test tone.

2 Press ^ / v repeatedly to select a speaker to adjust.

Each time you press v, the unit will cycle through the speakers in the following order:
 TEST LEFT (main L)→TEST CENTER (center)→
 TEST RIGHT (main R)→TEST R SUR. (rear R)→
 TEST L SUR. (rear L)→TEST SUBWOOFER
 (subwoofer)→.....
 (Press ^ to cycle the speakers in the reverse order.)

3 Press +/- to adjust speaker volumes.

4 Press TEST when you have completed your adjustment.

The test tone halts.

Notes

- You cannot enter test mode if headphones are connected to the PHONES jack. Remove the headphones from the PHONES jack.
- You cannot adjust speaker volumes if the "SOUND 1 SPEAKER SET" parameter on the set menu is set to NON.
- You cannot adjust the subwoofer level if the "ID BASS" parameter in "SOUND 1 SPEAKER SET" in the set menu is set to MAIN.
- If you select "BASIC 1 SETUP" in the set menu and then select "SET", speaker levels change in response to any changes you make in "BASIC 1 SETUP".



- Depending on the source the unit is reproducing, the speaker levels set with the test tone may not be to your liking. If this is the case, adjust the speaker levels while listening to the source.

SOUND FIELD PROGRAM PARAMETER EDITING

Changing parameter settings

The initial sound field program settings will provide you with an excellent listening experience as they are. It is not necessary to alter these settings, but you can create an original listening environment by doing so.

Note

- The editable parameters vary depending on the sound field program you select. Refer to the explanation for the parameter.

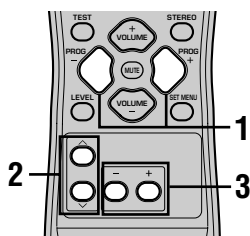

- Repeat steps 1 – 3 if you wish to alter other parameters.

Note

- You cannot alter these parameters if the “OPTION 2 MEM. GUARD” parameter in the Set menu is set to ON. Change this setting to OFF if you wish to alter any other parameters.

- Select a sound field program.

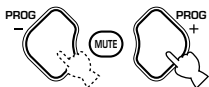

- Press \wedge / \vee to select the parameter you want to change.

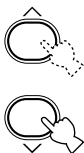

- Press $-/+$ to change the parameter setting.

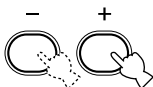

Digital sound field parameter descriptions

You can adjust the values of certain digital sound field parameters so the sound fields are recreated accurately in your listening room. Not all of the following parameters are found in every program.

■ DSP LEVEL

Function: This parameter adjusts the level of all the DSP effect sounds within a narrow range.

Description: Depending on the acoustics of your listening room, you may want to increase or decrease the DSP effect level relative to the direct sound.

Control Range: -6 dB to +3 dB

■ DELAY

Function: Adjusts the time difference between the beginning of the sound from the main speakers and the beginning of the sound effect from the rear speakers. The larger the value, the later the sound effect is generated.

Control range: 1 to 99 ms (Control range varies depending on the input source and the DSP program you use.)

For 5ch Stereo

Function: These parameters adjust the volume level for each channel in 5-channel stereo mode.

Control range: 0 to 100%

■ CT LEVEL (Center level)

■ RL LEVEL (Rear left level)

■ RR LEVEL (Rear right level)

For PRO LOGIC II Music

■ PANORAMA

Function: Extends the front stereo image to include the surround speakers for a wraparound effect.

Choices: OFF/ON, initial setting is OFF.

■ DIMENSION

Function: Gradually adjusts the soundfield either towards the front or towards the rear.

Control range: -3 (towards the rear) to +3 (towards the front), initial setting is STD (standard).

■ CT WIDTH (Center width)

Function: Adjusts the center image from all three front speakers to varying degrees. A larger value adjusts the center image towards the main left and right speakers.

Control range: 0 (center channel sound is output only from center speaker) to 7 (center channel sound is output only from main left and right speakers), initial setting is 3.

TROUBLESHOOTING

Refer to the chart below when this unit does not function properly. If the problem you are experiencing is not listed below or if the instruction below does not help, set this unit to standby mode, disconnect the power cord, and contact the nearest authorized YAMAHA dealer or service center.

■ General

Problem	Cause	Remedy	Refer to page
This unit fails to turn on when STANDBY/ ON (or POWER) is pressed, or enters in standby mode soon after the power has been turned on.	The power cord is not connected or the plug is not completely inserted.	Connect the power cord firmly.	–
	The protection circuitry has been activated.	Make sure all speaker wire connections on this unit and on all speakers are secure and that the wire for each connection is not touching anything other than its respective connection.	15 – 16
	This unit has been exposed to a strong external electric shock (such as lightning and strong static electricity).	Set this unit in standby mode, disconnect the power cord, plug it back in after 30 seconds, then use it normally.	–
No sound.	Incorrect input or output cable connections.	Connect the cables properly. If the problem persists, the cables may be defective.	9 – 16
	No appropriate input source is selected.	Select an appropriate input source with INPUT <◁ / ▷ or 6CH INPUT (or the input selector buttons).	21
	The speaker connections are not secure.	Secure the connections.	15 – 16
	The main speakers have not been selected properly.	Press and set SPEAKERS ON/OFF to ON, and select the proper main speakers with SPEAKERS A/B.	21
	The volume is turned down.	Turn up the volume.	22
	The sound is muted.	Press MUTE or any operation buttons on the unit to cancel mute and adjust the volume.	–
	Digital signals which this unit cannot reproduce are being received from a source component e.g.: a CD-ROM.	Play a source whose signals this unit can reproduce.	–
The sound suddenly goes off.	The protection circuit has been activated because of a short circuit, etc.	Check the speaker wires are not touching each other and then turn the unit back on.	–
	The sleep timer has turned the unit off.	Turn on the power, and play the source again.	–
	The sound is muted.	Press MUTE or any operation buttons on the unit to cancel a mute and adjust the volume.	–

Problem	Cause	Remedy	Refer to page
No sound / weak sound from particular speakers.	Incorrect cable connections.	Connect the cables properly. If the problem persists, the cables may be defective.	15
No sound from the effect speakers.	The sound effect is switched off.	Press STEREO to turn it on.	–
	A Dolby Surround, Dolby Digital or DTS decoding DSP program is being used with material not encoded with Dolby Surround, Dolby Digital or DTS.	Select another DSP program.	24 – 29
	A digital signal with a sampling frequency of greater than 48 kHz is input to this unit.		–
No sound from the center speaker.	The output level of the center speaker is set to minimum.	Raise the level of the center speaker.	45
	“SOUND 1A CENTER” on the set menu is set to NON.	Select the appropriate mode for your center speaker.	40
	One of the Hi-Fi DSP programs (1 to 4) has been selected (except for 5ch Stereo).	Select another DSP program.	24 – 29
	The source encoded with a Dolby Digital or DTS signal does not have a center channel signal.		–
No sound from the rear speakers.	The output level of the rear speakers is set to minimum.	Raise the output level of the rear speakers.	45
	A monaural source is being played with program 9.	Select another DSP program.	24 – 29
No sound from the subwoofer.	“SOUND 1D BASS” on the set menu is set to MAIN when a Dolby Digital or DTS signal is being played.	Select SWFR or BOTH.	41
	“SOUND 1D BASS” on the set menu is set to SWFR or MAIN when a 2-channel source is being played.	Select BOTH.	41
	The source does not contain low bass signals (90 Hz and below).		–
Poor bass reproduction.	“SOUND 1D BASS” on the set menu is set to SWFR or BOTH and your system does not include a subwoofer.	Select MAIN.	41
	The speaker mode settings (main, center or rear) on the set menu does not match your speaker configuration.	Select the appropriate position for each speaker based on the size of the speakers in your configuration.	40 – 41

Problem	Cause	Remedy	Refer to page
A “humming” sound can be heard.	Incorrect cable connections.	Firmly connect the audio plugs. If the problem persists, the cables may be defective.	–
The volume level cannot be increased, or the sound is distorted.	The component connected to the OUT (REC) jacks of this unit is turned off.	Turn on the power to the component.	–
The sound effect cannot be recorded.	It is not possible to record the sound effect with a recording component.		–
The sound field parameters and some other settings on the unit cannot be changed.	“OPTION 2 MEM.” in the set menu is set to ON.	Set “OPTION 2 MEM.” in the set menu to OFF.	–
The unit does not operate properly.	The internal microcomputer has been frozen by an external electric shock (such as lightning or excessive static electricity) or by a power supply with low voltage.	Disconnect the AC power cord from the outlet and then plug it in again after about 30 seconds.	–
“CHECK SP WIRES” appears on the front panel display.	The speaker cables are short circuited.	Make sure all speaker cables are connected correctly.	–
There is noise interference from digital or high-frequency equipment, or this unit.	This unit is too close to the digital or high-frequency equipment.	Move this unit further away from such equipment.	–
The unit suddenly turns into standby mode.	The internal temperature has become too high and the overheat protection circuitry has been activated.	Wait until the unit cools down and then turn it back on.	–

■ Tuner

Problem		Cause	Remedy	Refer to page
FM	FM stereo reception is noisy.	The characteristics of FM stereo broadcasts may cause this problem when the transmitter is too far away or the antenna input is poor.	Check the antenna connections. Try using a high-quality directional FM antenna.	12
			Use the manual tuning method.	31
	There is distortion, and clear reception cannot be obtained even with a good FM antenna.	There is multipath interference.	Adjust the antenna position to eliminate multipath interference.	–
	The desired station cannot be tuned in with the automatic tuning method.	The station is too weak.	Use a high-quality directional FM antenna.	–
Use the manual tuning method.			31	
Previously preset stations can no longer be tuned in.	The unit has been disconnected for a long period.	Re-store the stations.	32	
AM	The desired station cannot be tuned in with the automatic tuning method.	The signal is weak or the antenna connections are loose.	Tighten the AM loop antenna connections and orient it for best reception.	–
			Use the manual tuning method.	31
	There are continuous crackling and hissing noises.	Noises result from lightning, fluorescent lamps, motors, thermostats and other electrical equipment.	Use an outdoor antenna and a ground wire. This will help somewhat, but it is difficult to eliminate all noise.	12
	There are buzzing and whining noises (especially in the evening).	A TV set is being used nearby.	Move this unit away from the TV.	–

■ Remote control

Problem	Cause	Remedy	Refer to page
The remote control does not work nor function properly.	Wrong distance or angle.	The remote control will function within a maximum range of 6 m (20 feet) and no more than 30 degrees off-axis from the front panel.	7
	Direct sunlight or lighting (from an inverter type of fluorescent lamp, etc.) is striking the remote control sensor of this unit.	Reposition this unit.	–
	The batteries are weak.	Replace all batteries with new ones.	3

GLOSSARY

■ **Dolby Surround**

Dolby Surround uses a 4 channel analog recording system to reproduce realistic and dynamic sound effects: 2 main left and right channels (stereo), a center channel for dialog (monaural), and a rear channel for special sound effects (monaural). The rear channel reproduces sound within a narrow frequency range.

Dolby Surround is widely used with nearly all video tapes and laser discs, and in many TV and cable broadcasts as well. The Dolby Pro Logic decoder built into this unit employs a digital signal processing system that automatically stabilizes the volume on each channel to enhance moving sound effects and directionality.

■ **Dolby Digital**

Dolby Digital is a digital surround sound system that gives you completely independent multi-channel audio. With 3 front channels (left, center, and right), and 2 rear stereo channels, Dolby Digital provides 5 full-range audio channels. With an additional channel especially for bass effects, called LFE (low frequency effect), the system has a total of 5.1 channels (LFE is counted as 0.1 channel). By using 2-channel stereo for the rear speakers, more accurate moving sound effects and surround sound environment are possible than with Dolby Surround. The wide dynamic range (from maximum to minimum volume) reproduced by the 5 full-range channels and the precise sound orientation generated using digital sound processing provide listeners with previously unheard of excitement and realism.

With this unit, any sound environment from monaural up to a 5.1-channel configuration can be freely selected for your enjoyment.

■ **Matrix 6.1**

The unit incorporates Matrix 6.1 decoder for Dolby Digital and DTS multi-channel software that enables 6.1-channel reproduction by adding the rear center channel to existing 5.1-channel format. (The rear center channel is created from rear left and right channels, and outputted from virtual rear center speaker.) With this additional channel, you can experience more dynamic and realistic moving sound especially with scenes with “fly-over” and “fly-around” effects.

■ **Dolby Pro Logic II**

Dolby Pro Logic II is an improved technique used to decode vast numbers of existing Dolby Surround software. This new technology enables a discrete 5-channel playback with 2 main left and right channels, 1 center channel, and 2 rear left and right channels (instead of only 1 rear channel for conventional Pro Logic technology). A music mode is also available for 2-channel sources in addition to the movie mode.

■ **DTS (Digital Theater Systems) Digital Surround**

DTS digital surround was developed to replace the analog soundtracks of movies with a 6-channel digital sound track, and is now rapidly gaining popularity in movie theaters around the world. Digital Theater Systems Inc. has developed a home theater system so that you can enjoy the depth of sound and natural spatial representation of DTS digital surround in your home. This system produces practically distortion-free 6-channel sound (technically, a left, right and center channels, 2 rear channels, plus an LFE 0.1 channel as a subwoofer, for a total of 5.1 channels).

■ **LFE 0.1 channel**

This channel is for the reproduction of low bass signals. The frequency range for this channel is 20 Hz to 120 Hz. This channel is counted as 0.1 because it only enforces a low frequency range compared to the full-range reproduced by the other 5 channels in a Dolby Digital or DTS 5.1 channel systems.

■ **CINEMA DSP**

Since the Dolby Surround and DTS systems were originally designed for use in movie theaters, their effect is best felt in a theater having many speakers and designed for acoustic effects. Since home conditions, such as room size, wall material, number of speakers, and so on, can differ so widely, it's inevitable that there are differences in the sound heard as well. Based on a wealth of actually measured data, YAMAHA CINEMA DSP uses YAMAHA original sound field technology to combine Dolby Pro Logic, Dolby Digital and DTS systems to provide the visual and audio experience of movie theater in the listening room of your own home.

■ **SILENT CINEMA**

YAMAHA has developed a natural, realistic sound effect DSP algorithm for headphones. Parameters for headphones have been set for each sound field so that accurate representations of all the sound field programs can be enjoyed using headphones.

■ **Virtual CINEMA DSP**

YAMAHA has developed a virtual CINEMA DSP algorithm that allows you to enjoy DSP sound field surround effects even without any rear speakers by using virtual rear speakers.

It is even possible to enjoy virtual CINEMA DSP using a minimal 2-speaker system that does not include a center speaker.

■ PCM (Linear PCM)

Linear PCM is a signal format under which an analog audio signal is digitized, recorded and transmitted without using any compression. This is used as a method of recording CDs and DVD audio. The PCM system uses a technique for sampling the size of the analog signal per very small unit of time. Standing for “pulse code modulation”, the analog signal is encoded as pulses and then modulated for recording.

■ Sampling frequency and number of quantized bits

When digitizing an analog audio signal, the number of times the signal is sampled per second is called the sampling frequency, while the degree of fineness when converting the sound level into a numeric value is called the number of quantized bits.

The range of rates that can be played back is determined based on the sampling rate, while the dynamic range representing the sound level difference is determined by the number of quantized bits. In principle, the higher the sampling frequency, the wider the range of frequencies that can be played back, and the higher the number of quantized bits, the more finely the sound level can be reproduced.

SPECIFICATIONS

AUDIO SECTION

- Minimum RMS Output Power for Main, Center, Rear
 - 1 kHz, 0.1% THD, 6 Ω 70 W
 - [U.S.A. and Canada models] 70 W
 - [Other models] 60 W
 - 1 kHz, 0.7% THD, 6 Ω 75 W
 - [U.S.A. and Canada models] 75 W
 - [U.K., Europe, Australia and Korea models] 65 W
- DIN Standard Output Power
 - [Europe model] 75 W
 - 1 kHz, 0.7% THD, 4 Ω 75 W
- Maximum Power (EIAJ)
 - [China, Korea and General models] 80 W
 - 1 kHz, 10% THD, 6 Ω 80 W
- Dynamic Power (IHF, 6/4/2 Ω)
 - [U.S.A. and Canada models] 85/100/115 W
 - [Other models] 75/95/105 W
- Frequency Response
 - CD, etc. to Main L/R 10 Hz to 100 kHz, -3 dB
- Total Harmonic Distortion
 - 1 kHz, 30 W, 6 Ω , Main L/R 0.06%
- Signal to Noise Ratio (IHF-A Network)
 - CD (250 mV, shorted) to Main L/R, Effect Off ≥ 100 dB
- Residual Noise (IHF-A Network)
 - Main L/R 150 μ V or less
- Channel Separation (1 kHz/10 kHz)
 - CD, etc. (5.1 k Ω terminated) to Main L/R ≥ 60 dB/ ≥ 45 dB
- Tone Control (Main L/R)
 - BASS Boost/Cut ± 10 dB/100 Hz
 - TREBLE Boost/Cut ± 10 dB/20 kHz
- Phones Output 300 mV/470 Ω
- Input Sensitivity
 - CD, etc. 150 mV/47 k Ω
 - 6CH INPUT 150 mV/47 k Ω
- Output Level
 - OUT (REC) 150 mV/1.2 k Ω
 - OUTPUT SUBWOOFER 4 V/1.2 k Ω

VIDEO SECTION

- Video Signal Type NTSC or PAL
- Composite Video Signal Level 1 Vp-p/75 Ω
- Signal to Noise Ratio ≥ 50 dB
- Frequency Response (MONITOR OUT)
 - 5 Hz to 10 MHz, -3 dB

FM SECTION

- Tuning Range
 - [U.S.A. and Canada models] 87.5 to 107.9 MHz
 - [Other models] 87.50 to 108.00 MHz
- 50 dB Quieting Sensitivity (IHF, 100% mod.)
 - Mono/Stereo 2.0 μ V (17.3 dBf) /25 μ V (39.2 dBf)
- Selectivity (400 kHz) 70 dB
- Signal to Noise Ratio (IHF)
 - Mono/Stereo 76 dB/70 dB
- Harmonic Distortion (1 kHz)
 - Mono/Stereo 0.2%/0.3%
- Stereo Separation (1 kHz) 42 dB
- Frequency Response 20 Hz to 15 kHz +0.5, -2 dB

AM SECTION

- Tuning Range 530/531 to 1710/1611 kHz
- Usable Sensitivity 300 μ V/m

GENERAL

- Power Supply
 - [U.S.A. and Canada models] AC 120 V/60 Hz
 - [Australia model] AC 240 V/50 Hz
 - [U.K., Europe and Singapore models] AC 230 V/50 Hz
 - [Korea model] AC 220 V/60 Hz
 - [China model] AC 220 V/50 Hz
 - [General model] AC 110-120 V/220-240 V, 50/60 Hz
- Power Consumption
 - [U.S.A. and Canada models] 210 W/280 VA
 - [Other models] 210 W
 - Standby Mode 0.8 W or less
- Dimension (W x H x D) 435 x 151 x 322 mm
(17-1/8" x 5-15/16" x 12-11/16")
- Weight 8 kg (17 lbs 10 oz)

*Specifications are subject to change without notice.



YAMAHA ELECTRONICS CORPORATION, USA 6660 ORANGETHORPE AVE., BUENA PARK, CALIF. 90620, U.S.A.
YAMAHA CANADA MUSIC LTD. 135 MILNER AVE., SCARBOROUGH, ONTARIO M1S 3R1, CANADA
YAMAHA ELECTRONIK EUROPA G.m.b.H. SIEMENSSTR. 22-34, 25462 RELINGEN BEI HAMBURG, F.R. OF GERMANY
YAMAHA ELECTRONIQUE FRANCE S.A. RUE AMBROISE CROIZAT BP70 CROISSY-BEAUBOURG 77312 MARNE-LA-VALLEE CEDEX02, FRANCE
YAMAHA ELECTRONICS (UK) LTD. YAMAHA HOUSE, 200 RICKMANSWORTH ROAD WATFORD, HERTS WD1 7JS, ENGLAND
YAMAHA SCANDINAVIA A.B. J A WETTERGRENS GATA 1, BOX 30053, 400 43 VÄSTRA FRÖLUNDA, SWEDEN
YAMAHA MUSIC AUSTRALIA PTY, LTD. 17-33 MARKET ST., SOUTH MELBOURNE, 3205 VIC., AUSTRALIA

YAMAHA CORPORATION
Printed in China  WB14680



NS-P100/ NS-P106

(NS-P100/NS-P106: NX-E130 + NX-C130 + SW-P130)

*HOME CINEMA 5.1CH SPEAKER PACKAGE/
HOME CINEMA 6.1CH SPEAKER PACKAGE*



OWNER'S MANUAL

IMPORTANT SAFETY INSTRUCTIONS

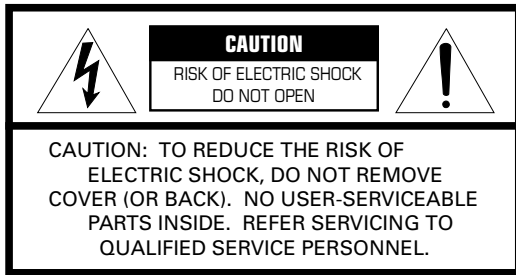

• Explanation of Graphical Symbols

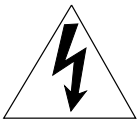

The lightning flash with arrowhead symbol, within an equilateral triangle, is intended to alert you to the presence of uninsulated "dangerous voltage" within the product's enclosure that may be of sufficient magnitude to constitute a risk of electric shock to persons.



The exclamation point within an equilateral triangle is intended to alert you to the presence of important operating and maintenance (servicing) instructions in the literature accompanying the appliance.

IMPORTANT

Please record the serial number of this system in the space below.

Model:

Serial No.:

The serial number is located on the rear of the main unit.

Retain this Owner's Manual in a safe place for future reference.

- 1 Read these instructions.
- 2 Keep these instructions.
- 3 Heed all warnings.
- 4 Follow all instructions.
- 5 Do not use this apparatus near water.
- 6 Clean only with dry cloth.
- 7 Do not block any ventilation openings. Install in accordance with the manufacturer's instructions.
- 8 Do not install near any heat sources such as radiators, heat registers, stoves, or other apparatus (including amplifiers) that produce heat.
- 9 Do not defeat the safety purpose of the polarized or grounding-type plug. A polarized plug has two blades with one wider than the other. A grounding type plug has two blades and a third grounding prong. The wide blade or the third prong are provided for your safety. If the provided plug does not fit into your outlet, consult an electrician for replacement of the obsolete outlet.
- 10 Protect the power cord from being walked on or pinched particularly at plugs, convenience receptacles, and the point where they exit from the apparatus.
- 11 Only use attachments/accessories specified by the manufacturer.
- 12 Use only with the cart, stand, tripod, bracket, or table specified by the manufacturer, or sold with the apparatus. When a cart is used, use caution when moving the cart/apparatus combination to avoid injury from tip-over. 
- 13 Unplug this apparatus during lightning storms or when unused for long periods of time.
- 14 Refer all servicing to qualified service personnel. Servicing is required when the apparatus has been damaged in any way, such as power-supply cord or plug is damaged, liquid has been spilled or objects have fallen into the apparatus, the apparatus has been exposed to rain or moisture, does not operate normally, or has been dropped.

- Be sure to allow spaces of at least 20 cm above, behind and on both sides of the unit.
- Do not place the following objects on this unit:
A vessel with water in it.
If the vessel falls by vibrations and water spills, it may cause damage to the unit, and/or you may get an electric shock.

FCC INFORMATION (for US customers only)

1. IMPORTANT NOTICE : DO NOT MODIFY THIS UNIT!

This product, when installed as indicated in the instructions contained in this manual, meets FCC requirements. Modifications not expressly approved by Yamaha may void your authority, granted by the FCC, to use the product.

2. IMPORTANT : When connecting this product to accessories and/or another product use only high quality shielded cables. Cable/s supplied with this product **MUST** be used. Follow all installation instructions. Failure to follow instructions could void your FCC authorization to use this product in the USA.

3. NOTE : This product has been tested and found to comply with the requirements listed in FCC Regulations, Part 15 for Class "B" digital devices. Compliance with these requirements provides a reasonable level of assurance that your use of this product in a residential environment will not result in harmful interference with other electronic devices.

This equipment generates/uses radio frequencies and, if not installed and used according to the instructions found in the users manual, may cause interference harmful to the operation of other electronic devices.

Compliance with FCC regulations does not guarantee that interference will not occur in all installations. If this product is found to be the source of interference, which can be determined by turning the unit "OFF" and "ON", please try to eliminate the problem by using one of the following measures:

Relocate either this product or the device that is being affected by the interference.

Utilize power outlets that are on different branch (circuit breaker or fuse) circuits or install AC line filter/s.

In the case of radio or TV interference, relocate/reorient the antenna. If the antenna lead-in is 300 ohm ribbon lead, change the lead-in to coaxial type cable.

If these corrective measures do not produce satisfactory results, please contact the local retailer authorized to distribute this type of product. If you can not locate the appropriate retailer, please contact Yamaha Electronics Corp., U.S.A. 6660 Orangethorpe Ave, Buena Park, CA 90620.

The above statements apply **ONLY** to those products distributed by Yamaha Corporation of America or its subsidiaries.

We Want You Listening For A Lifetime



YAMAHA and the Electronic Industries Association's Consumer Electronics Group want you to get the most out of your equipment by playing it at a safe level. One that lets the sound come through loud and clear without annoying blaring or distortion – and, most importantly, without affecting your sensitive hearing.

Since hearing damage from loud sounds is often undetectable until it is too late, YAMAHA and the Electronic Industries Association's Consumer Electronics Group recommend you to avoid prolonged exposure from excessive volume levels.

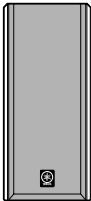
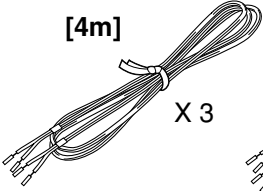
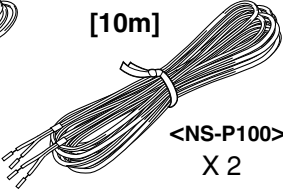

UNPACKING

Please check to make sure all listed items are included.

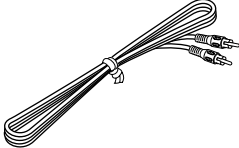
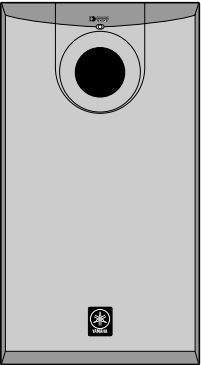
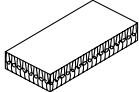
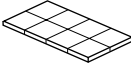
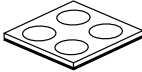
<ul style="list-style-type: none">● Main and rear speakers (and rear center speaker for NS-P106) <p>NX-E130</p>  <p><NS-P100> X 4 <NS-P106> X 5</p>	<ul style="list-style-type: none">● Speaker cables <p>[4m] X 3</p>  <p>[10m] X 2</p>  <p><NS-P100> X 2 <NS-P106> X 3</p>
<ul style="list-style-type: none">● Center speaker <p>NX-C130</p> 	<ul style="list-style-type: none">● Subwoofer cable 
<ul style="list-style-type: none">● Subwoofer <p>SW-P130</p> 	<ul style="list-style-type: none">● Fasteners (for NX-C130)  <p>X 2</p>
	<ul style="list-style-type: none">● Nonskid pads (for NX-E130)  <p><NS-P100> X 2 <NS-P106> X 3</p>
	<ul style="list-style-type: none">● Nonskid pads (for SW-P130) 

CAUTION: Read this before operating your unit.

- To assure the finest performance, please read this manual carefully. Keep it in a safe place for future reference.
- Install the speakers in a cool, dry, clean place – away from windows, heat sources, sources of excessive vibration, dust, moisture and cold. Avoid sources of humming (transformers, motors). To prevent fire or electric shock, do not expose the speakers to rain or water.
- To prevent the enclosure from warping or discoloring, do not place the speakers where they will be exposed to direct sunlight or excessive humidity.
- Avoid installing the speakers where foreign objects may fall onto them and/or where they may be exposed to liquid dripping or splashing.
Do not place the following objects on top of the speakers:
 - Other components, as they might cause damage and/or discoloration on the surface of the speakers.
 - Burning objects (i.e. candles), as they might cause fire, damage to the speakers and/or personal injury.
 - Containers with liquid in them, as they might cause electric shock to the user and/or damage to the speakers.
- Do not place the speakers where they are liable to be knocked over or struck by falling objects. Stable placement will also ensure better sound performance.
- Placing the speakers on the same shelf or rack as the turntable can result in feedback.
- Secure placement or installation is the owner's responsibility. YAMAHA shall not be liable for any accident caused by improper placement or installation of speakers.
- Any time you note distortion, reduce the volume control on your amplifier to a lower setting. Never allow your amplifier to be driven into "clipping". Otherwise the speakers may be damaged.
- When using an amplifier with a rated output power higher than the nominal input power of the speakers, care should be taken never to exceed the speakers' maximum input.
- Do not attempt to clean the speakers with chemical solvents as this might damage the finish. Use a clean, dry cloth.
- Do not attempt to modify or fix the speakers. Contact qualified YAMAHA service personnel when any service is needed. The cabinet should never be opened for any reason.
- Be sure to read the "TROUBLESHOOTING" section regarding common operating errors before concluding that the speakers are faulty.
- Do not plug in this unit to a wall outlet until all connections are completed.
- The voltage to be used must be the same as that specified on the rear panel. Using this unit with a higher voltage than specified is dangerous and may cause fire, damage to this unit, and/or personal injury. YAMAHA will not be held responsible for any damage resulting from use of this unit with a voltage other than specified.
- To prevent lightning damage, disconnect the AC power plug when there is an electric storm.
- Super-bass frequencies reproduced by this unit may cause a turntable to generate a howling sound. In such a case, move this unit away from the turntable.
- This unit may be damaged if certain sounds are continuously outputted at high volume level. For example, if 20 Hz–50 Hz sine waves from a test disc, bass sounds from electronic instruments, etc. are continuously outputted, or when the stylus of a turntable touches the surface of a disc, reduce the volume level to prevent this unit from being damaged.
- If you hear distorted noise (i.e. unnatural, intermittent "rapping" or "hammering" sounds) coming from this unit, reduce the volume level. Extremely loud playing of a movie soundtrack's low frequency, bass-heavy sounds or similarly loud popular music passages can damage this speaker system.
- Vibration generated by super-bass frequencies may distort images on a TV. In such a case, move this unit away from the TV set.
- When disconnecting the power cord from the wall outlet, grasp the plug; do not pull the cord.
- When not planning to use this unit for a long period (i.e. vacation, etc.), disconnect the AC power plug from the wall outlet.

● **VOLTAGE SELECTOR**
(For China, Korean and General models)
The voltage selector switch on the rear panel of this unit must be set for your local main voltage **BEFORE** plugging this unit into the AC main supply.
Voltages are 110-120/220-240 V AC, 50/60 Hz.

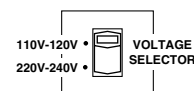

For SW-P130

- Do not operate this unit upside down. It may overheat, possibly causing damage.
- Do not use excessive force on switches, controls or connection wires. When moving this unit, first disconnect the power plug and the wires connected to other equipments. Never pull the wires themselves.
- Since this unit has a built-in power amplifier, heat will radiate from the rear panel. Place the unit apart from the walls, allowing at least 20 cm of space above, behind and on both sides of the unit to prevent fire or damage. Furthermore, do not position with the rear panel facing down on the floor or other surfaces.
- When using a humidifier, be sure to avoid condensation inside this unit by allowing enough spaces around this unit or avoiding excess humidification. Condensation might cause a fire, damage to this unit, and/or electric shock.
- Do not cover the rear panel of this unit with a newspaper, a tablecloth, a curtain, etc. in order not to obstruct heat radiation. If the temperature inside this unit rises, it may cause fire, damage to this unit and/or personal injury.

Standby mode
If the POWER switch is set to the ON position and the AUTO STANDBY switch is set to the HIGH or LOW position, this unit turns into the standby mode when no signal is received by this unit for 7 to 8 minutes.
In this state, this unit is designed to consume a very small quantity of power.

WARNING
TO REDUCE THE RISK OF FIRE OR ELECTRIC SHOCK, DO NOT EXPOSE THIS UNIT TO RAIN OR MOISTURE.

For Canadian Customers

To prevent electric shock, match wide blade of plug to wide slot and fully insert.

This Class B digital apparatus complies with Canadian ICES-003.

For U.K. customers

If the socket outlets in the home are not suitable for the plug supplied with this appliance, it should be cut off and an appropriate 3 pin plug fitted. For details, refer to the instructions described below.

Note: The plug severed from the mains lead must be destroyed, as a plug with bared flexible cord is hazardous if engaged in a live socket outlet.

SPECIAL INSTRUCTIONS FOR U.K. MODEL

IMPORTANT:

THE WIRES IN MAINS LEAD ARE COLOURED IN ACCORDANCE WITH THE FOLLOWING CODE:

Blue: NEUTRAL

Brown: LIVE

As the colours of the wires in the mains lead of this apparatus may not correspond with the coloured markings identifying the terminals in your plug, proceed as follows: The wire which is coloured BLUE must be connected to the terminal which is marked with the letter N or coloured BLACK. The wire which is coloured BROWN must be connected to the terminal which is marked with the letter L or coloured RED. Making sure that neither core is connected to the earth terminal of the three pin plug.

COMPONENTS OF THE PACKAGE

The speaker package "NS-P100 and NS-P106" is designed for use in a multi-channel audio system such as a home theater system.

NS-P100 includes four NX-E130 speaker systems, one NX-C130 speaker system and one SW-P130 subwoofer system.

NS-P106 includes five NX-E130 speaker systems, one NX-C130 speaker system and one SW-P130 subwoofer system.

<NX-E130>

Full range acoustic-suspension speaker system used for the main and rear speakers (and rear center speaker for NS-P106)

<NX-C130>

Full range acoustic-suspension speaker system used for the center speaker

<SW-P130>

Active Servo Processing Subwoofer System with a built-in power amplifier

- This subwoofer system employs Advanced Yamaha Active Servo Technology which YAMAHA has developed for reproducing higher quality super-bass sound. (Refer to page 12 for details on Advanced Yamaha Active Servo Technology.) This super-bass sound adds a more realistic, theater-in-the-home effect to your stereo system.
- The AUTO STANDBY switch saves you the trouble of setting the POWER switch to the ON or OFF position.

CONTENTS

IMPORTANT SAFETY INSTRUCTIONS	II
UNPACKING	IV
CAUTION	1
COMPONENTS OF THE PACKAGE	2
SETTING UP THE SPEAKERS	3
Placing the subwoofer	4
Placing the center speaker	4
Mounting the rear speakers (and rear center speaker for NS-P106)	5
Placing the main/rear speakers (and rear center speaker for NS-P106)	6

CONNECTIONS	7
An example of basic connections	7
How to connect speaker cables	8
USING THE SUBWOOFER (SW-P130)	9
Controls and their functions	9
Automatic-power-switching function	10
Adjusting the subwoofer before use	10
Frequency characteristics	11
ADVANCED YAMAHA ACTIVE SERVO TECHNOLOGY (for SW-P130)	12
TROUBLESHOOTING	13
SPECIFICATIONS	14

SETTING UP THE SPEAKERS

Before making connections, place all speakers in their respective positions. The positioning of the speakers is important because it controls the whole sound quality of this system.

Place the speakers depending on your listening position by following the instructions below.

Speaker configuration

<NS-P100>

This speaker package employs a 6 speaker configuration: 2 main speakers, 2 rear speakers, a center speaker and a subwoofer.

The main speakers emit main source sound. The rear speakers emit surround sounds, and the center speaker emits center sounds (dialog etc.). The subwoofer emits reinforcing low frequencies on your audio system.

<NS-P106>

This speaker package employs a 7 speaker configuration: 2 main speakers, 2 rear speakers, a center speaker, a rear center speaker and a subwoofer.

The main speakers emit main source sound. The rear and rear center speakers emit surround sounds, and the center speaker emits center sounds (dialog etc.). The subwoofer emits reinforcing low frequencies on your audio system.

Note

In this speaker package, the same speakers (NX-E130) are used for the main and rear speakers (and rear center speaker for NS-P106).

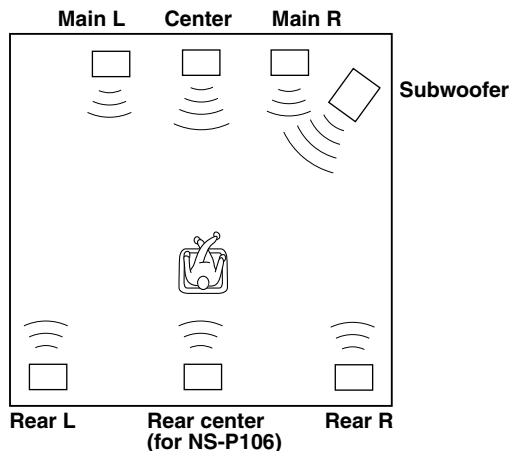

Placing speakers

Main speakers: On both sides of and at approximately the same height as the TV set.

Rear speakers: Behind your listening position, facing slightly inward. About 1.8 m (approx. 6 feet) from the floor.

Center speaker: Precisely between the main speakers.

Rear center speaker (for NS-P106):

Precisely between the rear speakers.

Subwoofer:

The position of the subwoofer is not so critical because low bass tones are not highly directional.

Refer to "Placing the subwoofer" on page 4 for a recommended positioning of the subwoofer.

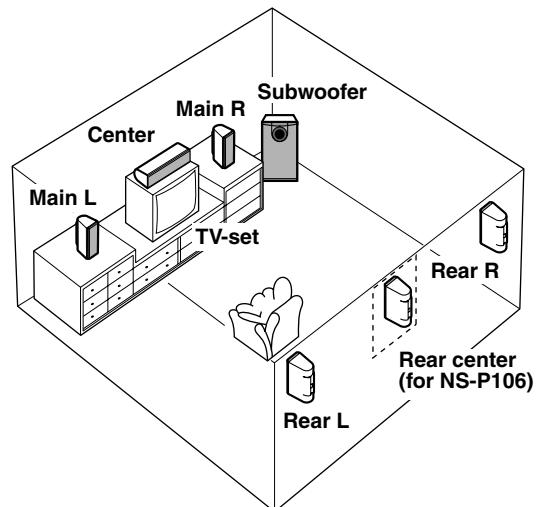

These speakers feature a magnetically shielded design, but there is still a chance that placing them too close to a TV set might impair picture color. Should this happen, move the speakers away from the TV set.

■ Placing the subwoofer

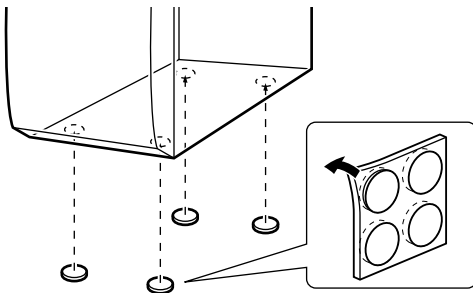
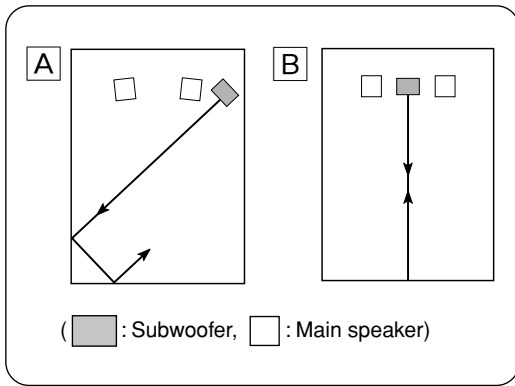

It is recommended to place the subwoofer on the outside of either the right or the left main speaker. (See fig. [A].) The placement shown in fig. [B] is also possible, however, if the subwoofer system is placed directly facing the wall, the bass effect may die because the sound from it and the sound reflected by the wall may cancel out each other. To prevent this from happening, face the subwoofer system at an angle as shown in fig. [A].

Note

There may be a case that you cannot obtain enough super-bass sounds from the subwoofer when listening in the center of the room. This is because “standing waves” have been developed between two parallel walls and they cancel the bass sounds.

In such a case, face the subwoofer obliquely to the wall. It also may be necessary to break up the parallel surfaces by placing bookshelves etc. along the walls.

Use the nonskid pads

Put the provided nonskid pads at the four corners on the bottom of the subwoofer to prevent the subwoofer from moving by vibrations etc.

■ Placing the center speaker

You can place the speaker on top of the TV if the top is flat, on the floor under the TV, or inside the TV rack. Be sure to place the speaker in a stable position.

When placing the speaker on top of the TV, to prevent the speaker from falling, attach the provided fasteners at two points on the bottom of the speaker and on the top of the TV.

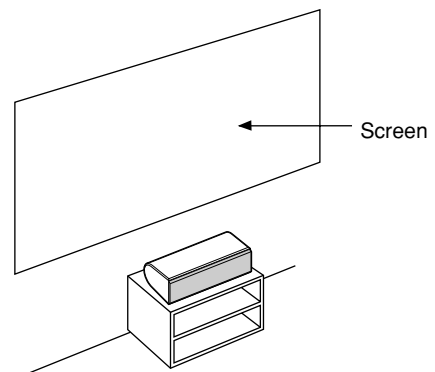
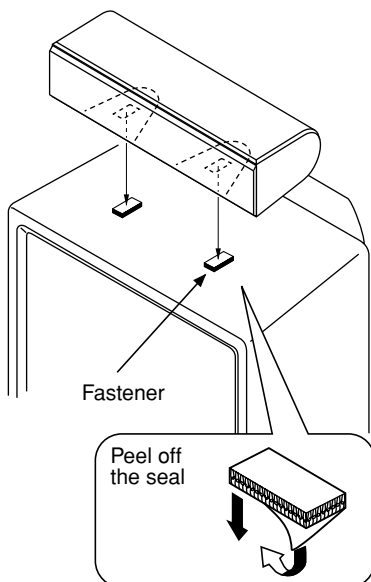

Notes

- Do not place the speaker on top of a TV whose area is smaller than the bottom of the speaker. If placed, the speaker may fall and cause injury.
- Do not place the speaker on top of a TV if the top is inclined.
- Do not touch the adhesive surface after peeling off the seal as this will weaken its adhesive strength.
- Thoroughly wipe clean the surface where the fastener is to be applied. Note that adhesive strength is weakened if the surface is dirty, oily or wet and that this may cause the center speaker to fall.

■ Mounting the main/rear speakers (and rear center speaker for NS-P106)

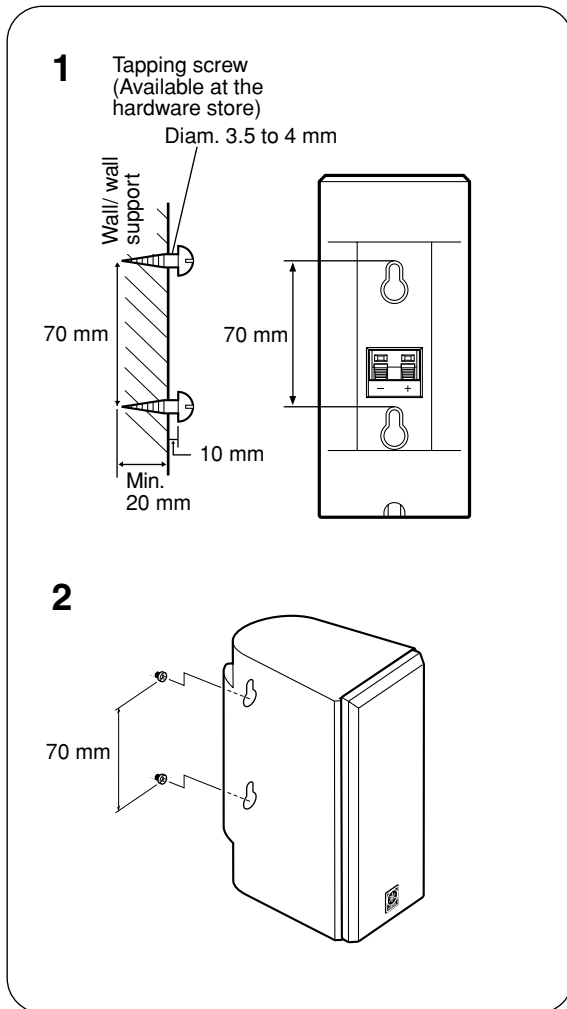

Mount the main/rear speakers (and rear center speaker for NS-P106) on a shelf, rack or directly on the floor, or hang them on the wall.

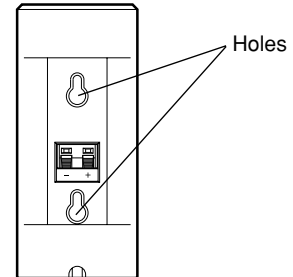

To mount the speakers on a wall by using the holes on the speakers' back panels

- 1** Fasten screws into a firm wall or wall support as shown in the figure.
- 2** Hang the speaker by mounting the holes on the protruding screws.
 - * Make sure that the screws are securely affixed by the narrow parts of the holes.

WARNING

- Each speaker weighs 0.9 kg (2 lbs.). Do not mount them on thin plywood or a wall composed of a soft surface material. If mounted, the screws may pull out of the flimsy surface and the speakers may fall. This may damage the speakers or cause personal injury.
- Do not affix the speakers to a wall using nails, adhesives, or any other unstable hardware. Long-term use and vibrations may cause the speakers to fall.
- To avoid accidents resulting from tripping over loose speaker cables, fix the cables to the wall.
- Select an appropriate position on the wall to mount the speaker so that no one will injure his/her head or face.

Using the Yamaha Speaker Stand SPS-80 (option)

By using the Yamaha Speaker Stand SPS-80, speakers can be placed on the floor.

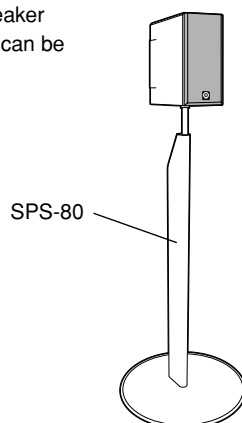

* The SPS-80 is not available in some areas.

■ Placing the the main/rear speakers (and rear center speaker for NS-P106)

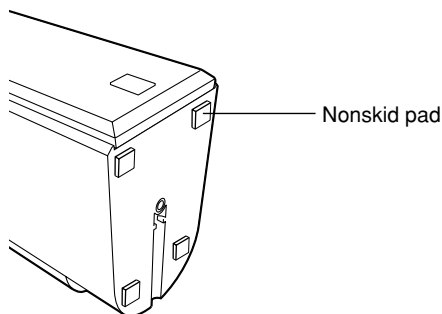

When placing the speakers on a flat surface, attach the included nonskid pads to the corners on the bottom of the speakers as shown on the left. This prevents the speakers from sliding around.

* For NS-P106, the nonskid pads include four spare ones.

If you want to mount a speaker on a commercially available speaker stand for the main/rear speakers (and rear center speaker for NS-P106)

The following optional accessories are needed for mounting the speakers on commercially available speaker stands.

* Inquire at your authorized YAMAHA dealer for the optional accessories.

Mounting bracket (AAX34790)

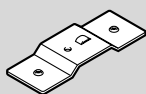

<NS-P100>
X 4
<NS-P106>
X 5

Screw (AAX12390)



<NS-P100>
X 4
<NS-P106>
X 5

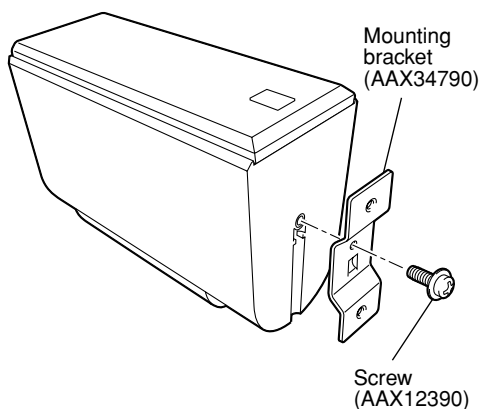

1 Attach the bracket (AAX34790) to the bottom of the speaker by using the screw (AAX12390) so that the convex part of the bracket fits in the grooved part on the bottom of the speaker as shown on the left.

2 Mount the speaker on the speaker stand by using a pair of screw holes (at an interval of 60 mm) on the bracket.

* Those screw holes can be used with M4 screws only.

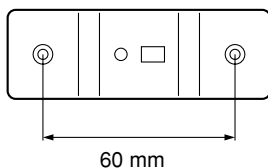

CONNECTIONS

Caution: Plug in the subwoofer and other audio/video components after all connections are completed.

■ An example of basic connections

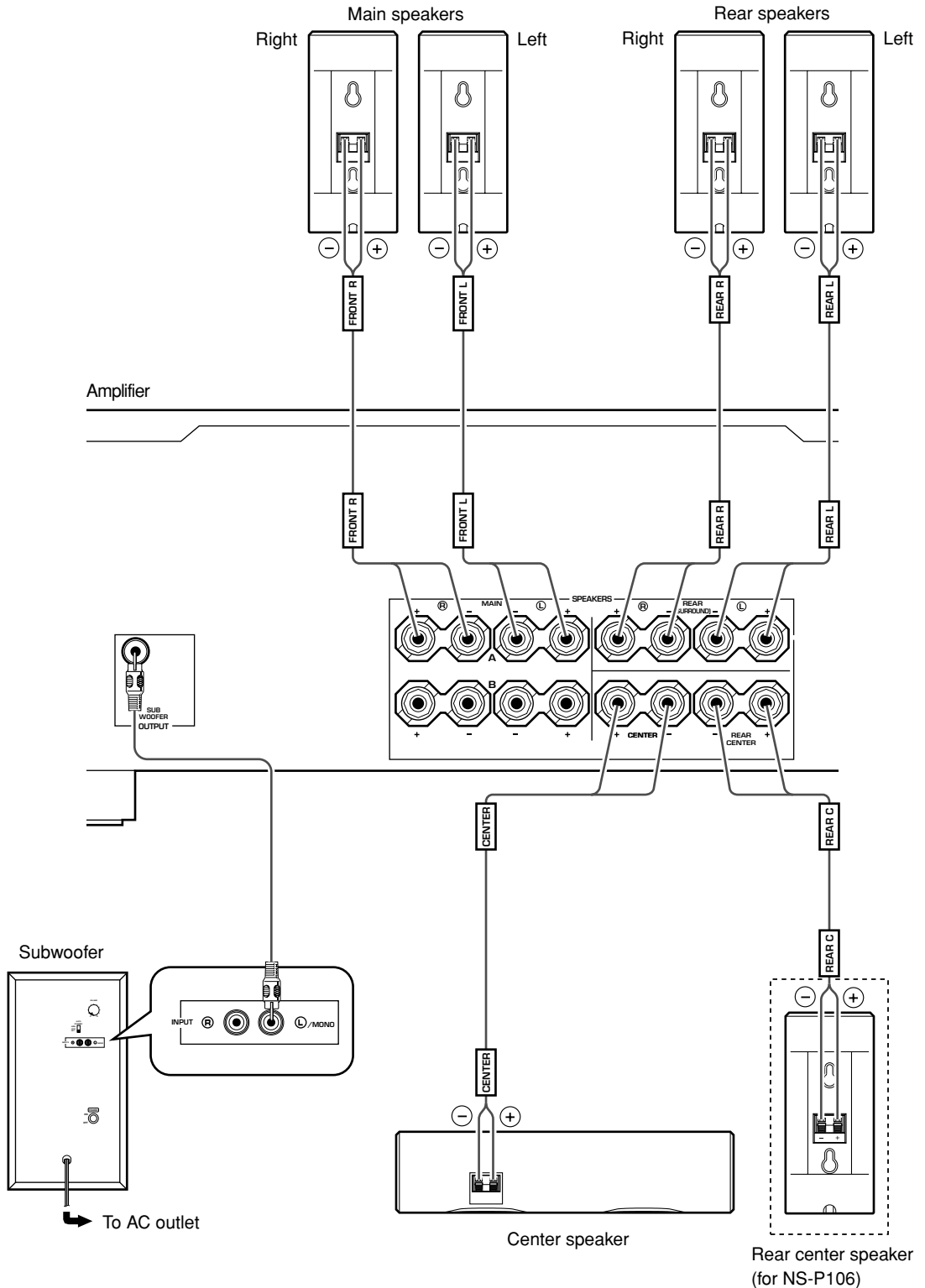

- Connect the main, center and rear speakers (and rear center speaker for NS-P106) to the speaker output terminals of your amplifier with the provided speaker cables.
 - * The provided speaker cables have labels marked FRONT L, FRONT R, CENTER, REAR L, REAR R (and REAR C for NS-P106). Connect each speaker cable to the corresponding speaker by following the figure on page 7.

(The speaker cables marked FRONT L/R are used for connecting the main speakers to the MAIN speakers' terminals on the amplifier.)
 - * Connect each speaker making sure not to reverse the polarity (+, -). If the speaker is connected with reversed polarity, the sound will be unnatural and lack bass.
 - * For the main and rear speakers only, connect one speaker to the left (marked L) terminals of your amplifier, and another speaker to the right (marked R) terminals.

- Connect the subwoofer to the line output (pin jack) terminal(s) of the amplifier.
 - * To connect with a YAMAHA DSP amplifier (or AV receiver), connect the SUBWOOFER (or LOW PASS etc.) terminal on the rear of the DSP amplifier (or AV receiver) to the (L)/MONO INPUT terminal of the subwoofer.
 - * To connect the subwoofer to the SPLIT SUBWOOFER terminals on the rear of the DSP amplifier, connect them to both the left (L)/MONO and right (R) INPUT terminals of the subwoofer.

Note

When connecting to a monaural line output terminal of the amplifier, connect to the (L)/MONO INPUT terminal.

How to connect speaker cables

For connections, keep the speaker cables as short as possible. Do not bundle or roll up the excess part of the cables. If the connections are faulty, no sound will be heard from the speakers.

Before connecting

Remove the insulation coating at the extremity of each speaker cable by twisting the coating off.

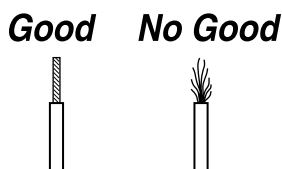

One side of the provided speaker cable has a white broken line and the other side has no line. Connect the (+) terminals on both the speaker and the amplifier using the side with a white broken line. Connect the (-) terminals on both components using the side with no line.

How to Connect:

- ① Press and hold the terminal's tab, as shown in the figure.
- ② Insert the bare wire.
- ③ Release your finger from the tab to allow it to lock securely on the cable's wire end.
- ④ Test the firmness of the connection by pulling lightly on the cable at the terminal.

Red: positive (+)
Black: negative (-)

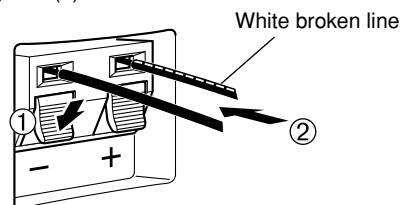

Note

Do not let the bare speaker wires touch each other as this could damage the speaker or the amplifier, or both of them.

USING THE SUBWOOFER (SW-P130)

■ Controls and their functions

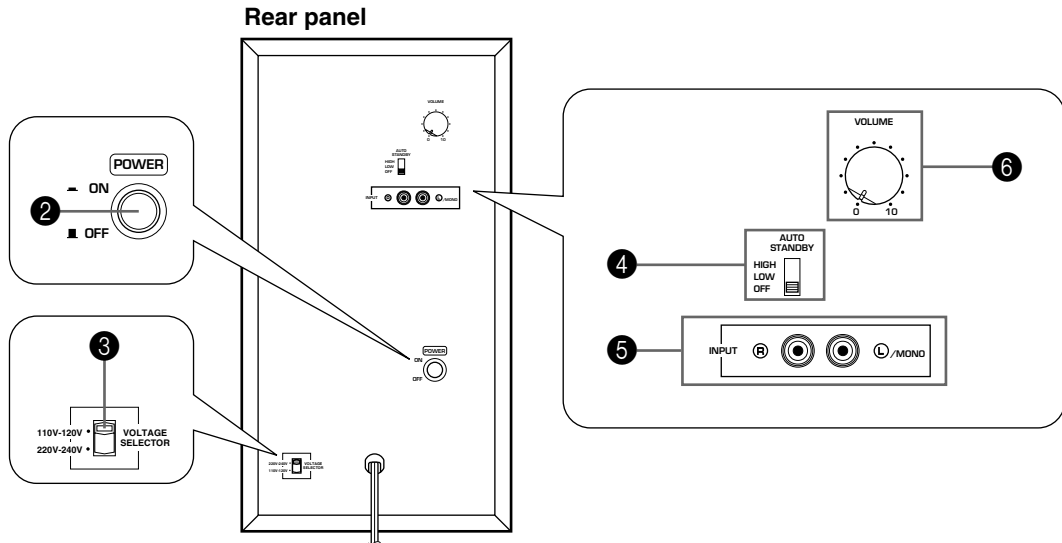
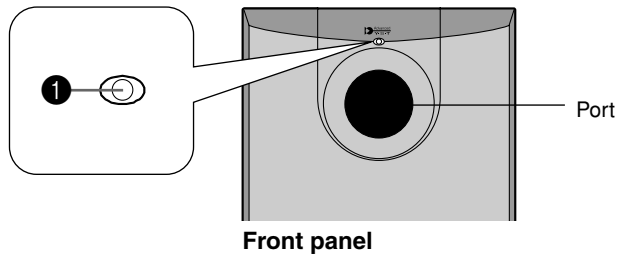

- 1** Power indicator
Lights up GREEN when the **POWER** switch (2) is pressed in to the ON position and goes off when set to the OFF position.

* Standby mode

If the **POWER** switch (2) is pressed in to the ON position and the **AUTO STANDBY** switch (4) is set to the HIGH or LOW position, this indicator lights up RED when no signal is received by the subwoofer.

- 2** **POWER** switch
Press this switch to the ON position to turn on the power of the subwoofer. When the power of the subwoofer is on, the power indicator (1) on the front panel lights up GREEN. Press this switch again to set to the OFF position to turn off the power of the subwoofer.

- 3** **VOLTAGE SELECTOR** switch
(For China, Korean and General models)
If the preset setting of the switch is incorrect, set the switch to the proper voltage range (220V-240V or 110V-120V) of your area.

Consult your dealer if you are unsure of the correct setting.

WARNING

Be sure to unplug the subwoofer before setting the VOLTAGE SELECTOR switch correctly.

- 4** **AUTO STANDBY (HIGH/LOW/OFF)** switch
This switch is originally set to the OFF position. By setting this switch to the HIGH or LOW position, the subwoofer's automatic power-switching function operates as explained on page 10. If you do not need this function, set to the OFF position.
* Make sure to change the setting of this switch only when the **POWER** switch (2) is in the OFF position.

- 5** **INPUT** terminals
Used to input line level signals from the amplifier.

- 6** **VOLUME** control
Adjusts the volume level. Turn the control clockwise to increase the volume, and counterclockwise to decrease the volume.

■ Automatic power-switching function

If the source being played is stopped and the input signal is cut off for 7 to 8 minutes, the subwoofer automatically switches to the standby mode. (When the subwoofer switches to the standby mode by the automatic power-switching function, the power indicator lights up in red.) When you play a source again, the power of the subwoofer turns on automatically by sensing audio signals input to the subwoofer.

This function will operate by sensing a certain level of low frequency input signal. Usually set the **AUTO STANDBY** switch to the LOW position. However, if the power is not switched on or to the standby mode smoothly, set the switch to the HIGH position. In the HIGH position, the power will turn on even with a low level of input signal. But please be aware that the subwoofer may not switch to the standby mode when there is an extremely low input signal.

- * The power might turn on unexpectedly by sensing noise from other appliances. If that occurs, set the **AUTO STANDBY** switch to the OFF position and use the **POWER** switch to switch the power between ON and OFF manually.
- * This function detects the low-frequency components below 200 Hz of the input signals (i.e., the explosion in the action movie, the sound of the bass guitar or the bass drum, etc.).
- * The minutes required to switch the subwoofer to the standby mode might change by sensing noise from other appliances.

This function is available only when the power of the subwoofer is on (by pressing the POWER switch).

■ Adjusting the subwoofer before use

Before using the subwoofer, adjust the subwoofer to obtain the optimum volume balance between the subwoofer and the main speakers by following the procedures described below.

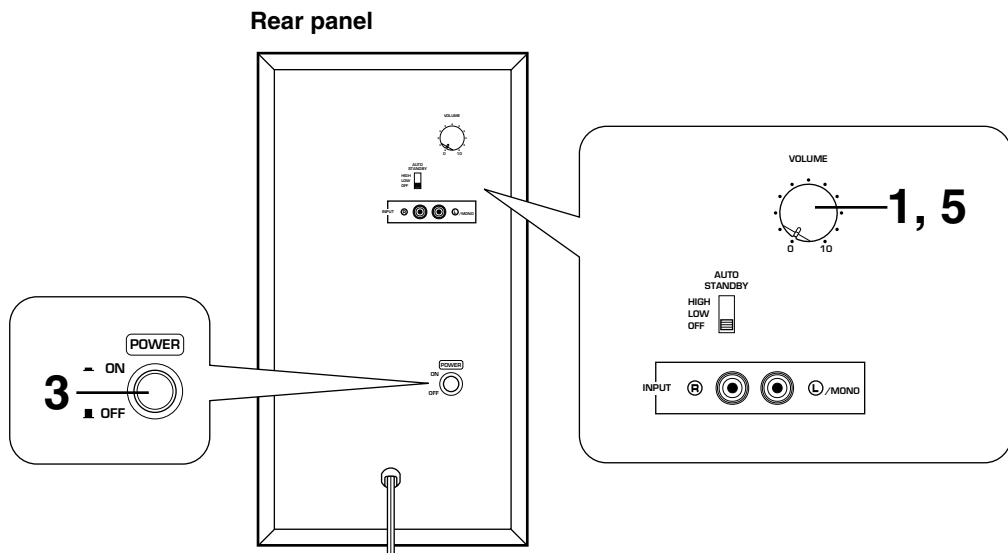

- 1 Set the **VOLUME** control to minimum (0).
- 2 Turn on the power of all the other components.
- 3 Press the **POWER** switch to the ON position.
 - * The power indicator on the front panel lights up in green.
- 4 Play a source containing low-frequency components and adjust the amplifier's volume control to the desired listening level.
- 5 Increase the volume gradually to adjust the volume balance between the subwoofer and the main speakers.

Normally, set the control to the level where you can obtain a little more bass effect than when this unit is not used.

- Once the volume balance between the subwoofer and the main speakers is adjusted, you can adjust the volume of your whole sound system by using the amplifier's volume control. However, if you change the main speakers (NX-E130) to others, you must make this adjustment again.
- For adjusting the **VOLUME** control, refer to "Frequency characteristics" below.

■ Frequency characteristics

Fig. 1 shows the frequency characteristics of the subwoofer.

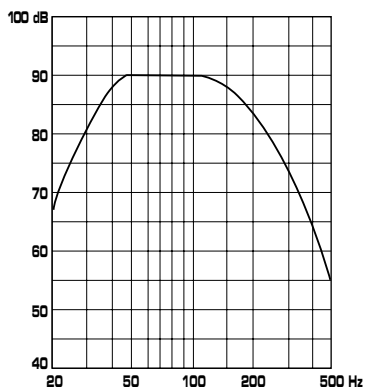

Fig. 1

Fig. 2 shows the frequency characteristics when the subwoofer is combined with NX-E130 and the subwoofer's volume level is set to the figured position.

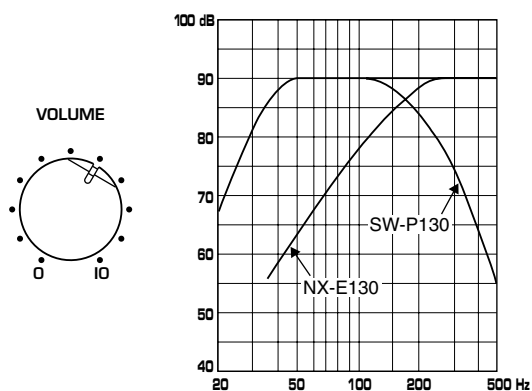

Fig. 2

ADVANCED YAMAHA ACTIVE SERVO TECHNOLOGY (for SW-P130)

The theory of Yamaha Active Servo Technology has been based upon two major factors, the Helmholtz resonator and negative-impedance drive. Active Servo Processing speakers reproduce the bass frequencies through an “air woofer”, which is a port or opening in the speaker’s cabinet. This opening is used instead of, and performs the functions of, a woofer in a conventionally designed speaker system. Thus, signals of low amplitude within the cabinet can, according to the Helmholtz resonance theory, be outputted from this opening as waves of great amplitude if the size of the opening and the volume of the cabinet are in the correct proportion to satisfy a certain ratio.

In order to accomplish this, moreover, the amplitudes within the cabinet must be both precise and of sufficient power because these amplitudes must overcome the “load” presented by the air that exists within the cabinet.

Thus it is this problem that is resolved through the employment of a new design in which the amplifier supplies special signals. If the electrical resistance of the voice coil could be reduced to zero, the movement of the speaker unit would become linear with respect to signal voltage. To accomplish this, a special negative-impedance output-drive amplifier for subtracting output impedance of the amplifier is used.

By employing negative-impedance drive circuits, the amplifier is able to generate precise, low-amplitude, low-frequency waves with superior damping characteristics. These waves are then radiated from the cabinet opening as high-amplitude signals. The system can, therefore, by employing the negative-impedance output drive amplifier and a speaker cabinet with the Helmholtz resonator, reproduce an extremely wide range of frequencies with amazing sound quality and less distortion.

The features described above, then, are combined to be the fundamental structure of the conventional Yamaha Active Servo Technology.

Our new Active Servo Technology — Advanced Yamaha Active Servo Technology — adopted Advanced Negative Impedance Converter (ANIC) circuits, which allows the conventional negative impedance converter to dynamically vary in order to select an optimum value for speaker impedance variation. With this new ANIC circuits, Advanced Yamaha Active Servo Technology can provide more stable performance and improved sound pressure compared with the conventional Yamaha Active Servo Technology, resulting in more natural and dynamic bass reproduction.

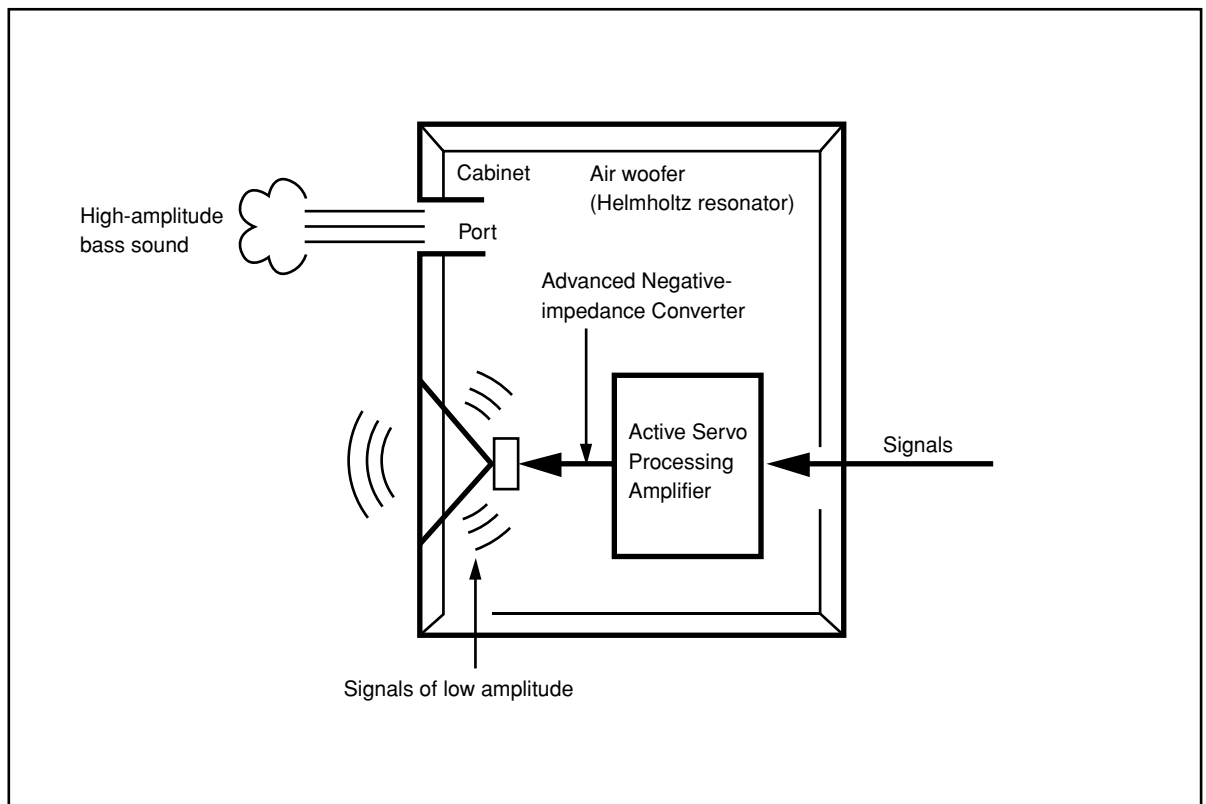

TROUBLESHOOTING

Refer to the chart below when this unit does not function properly. If the problem you are experiencing is not listed below or if the instructions given below do not help, disconnect the power cord and contact your authorized YAMAHA dealer or service center.

Problem	Cause	What to Do
No sound.	Speaker cables are not connected securely.	Connect them securely.
Sound level is too low.	Speaker cables are not connected correctly.	Connect them correctly, that is L (left) to L, R (right) to R, “+” to “+” and “-” to “-”.

For SW-P130

Problem	Cause	What to Do
Power is not supplied even though the POWER switch is set to the ON position.	The power plug is not securely connected.	Connect it securely.
No sound.	The VOLUME control is set to 0.	Turn the VOLUME control to the right (clockwise).
	Speaker cables are not connected securely.	Connect them securely.
Sound level is too low.	Speaker cables are not connected correctly.	Connect them correctly, that is L (left) to L, R (right) to R, “+” to “+” and “-” to “-”.
	A source sound with few bass frequencies is played.	Play a source sound with bass frequencies.
	It is influenced by standing waves.	Reposition the subwoofer or break up the parallel surface by placing bookshelves etc. along the walls.
The subwoofer does not turn on automatically.	The POWER switch is set to the OFF position.	Set the POWER switch to the ON position.
	The AUTO STANDBY switch is set to the OFF position.	Set the AUTO STANDBY switch to the “HIGH” or “LOW” position.
	The level of input signal is too low.	Set the AUTO STANDBY switch to the “HIGH” position.
The subwoofer does not turn into the standby mode automatically.	There is an influence of noise generated from external appliances etc.	Move the subwoofer farther away from such appliances and/or reposition the connected speaker cables. Otherwise, set the AUTO STANDBY switch to the “OFF” position.
	The AUTO STANDBY switch is set to the OFF position.	Set the AUTO STANDBY switch to the “HIGH” position.
The subwoofer turns into the standby mode unexpectedly.	The level of input signal is too low.	Set the AUTO STANDBY switch to the “HIGH” position.
The subwoofer turns on unexpectedly.	There is an influence of noise generated from external appliances etc.	Move the subwoofer farther away from such appliances and/or reposition the connected speaker cables. Otherwise, set the AUTO STANDBY switch to the “OFF” position.

SPECIFICATIONS

■ NX-E130, NX-C130

Type Full range acoustic-suspension speaker system
Magnetic shielding type

Driver 5 cm (2") full range cone speaker x 2

Nominal Input Power 30W

Maximum Input Power 100W

Impedance 6Ω

Frequency Response

<NX-E130> 100 Hz to 25 kHz

<NX-C130> 80 Hz to 25 kHz

Sensitivity 86 dB/2.83V/m

Dimensions (W x H x D)

<NX-E130> 72 mm x 164 mm x 111 mm
(2-13/16" x 6-7/16" x 4-3/8")

<NX-C130> 300 mm x 72 mm x 110 mm
(11-13/16" x 2-13/16" x 4-5/16")

Weight

<NX-E130> 0.9 kg (2 lbs.)

<NX-C130> 1.1 kg (2 lbs. 7 oz.)

■ SW-P130

Type Advanced Yamaha Active Servo Technology
Magnetic shielding type

Driver 16 cm (6-1/2") cone woofer

Amplifier Output

U.S.A. and Canada models 55 W/5Ω

Other models 50 W/5Ω

Dynamic Power 100 W/5Ω

Frequency Response 30 Hz to 200 Hz

Power Supply

U.S.A. and Canada models AC 120V, 60 Hz

U.K. and Europe models AC 230V, 50 Hz

Australia model AC 240V, 50 Hz

China, Korean and General models
..... AC 110-120/220-240V, 50/60 Hz

Power Consumption 60 W
(In the standby mode: 0.8 W)

Dimensions (W x H x D) 200 mm x 365 mm x 375 mm
(7-7/8" x 14-7/20" x 14-3/4")

Weight 8.5 kg (18 lbs. 11 oz.)

* Specifications are subject to change without notice due to product improvements.



YAMAHA ELECTRONICS CORPORATION, USA 6660 ORANGETHORPE AVE., BUENA PARK, CALIF. 90620, U.S.A.
YAMAHA CANADA MUSIC LTD. 135 MILNER AVE., SCARBOROUGH, ONTARIO M1S 3R1, CANADA
YAMAHA ELECTRONIK EUROPA G.m.b.H. SIEMENSSTR. 22-34, 25462 RELINGEN BEI HAMBURG, F.R. OF GERMANY
YAMAHA ELECTRONIQUE FRANCE S.A. RUE AMBROISE CROIZAT BP70 CROISSY-BEAUBOURG 77312 MARNE-LA-VALLEE CEDEX02, FRANCE
YAMAHA ELECTRONICS (UK) LTD. YAMAHA HOUSE, 200 RICKMANSWORTH ROAD WATFORD, HERTS WD1 7JS, ENGLAND
YAMAHA SCANDINAVIA A.B. J A WETTERGRENS GATA 1, BOX 30053, 400 43 VÄSTRA FRÖLUNDA, SWEDEN
YAMAHA MUSIC AUSTRALIA PTY, LTD. 17-33 MARKET ST., SOUTH MELBOURNE, 3205 VIC., AUSTRALIA

YAMAHA CORPORATION
Printed in China  WB32590



DVD / VIDEO CD / CD PLAYER

DVD-S540

OWNER'S MANUAL

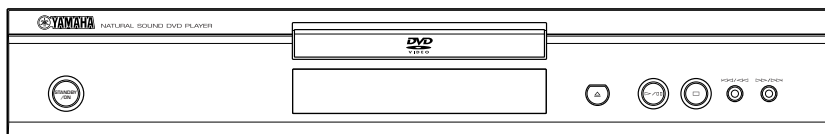



This symbol warns the user that uninsulated voltage within the unit may have sufficient magnitude to cause electric shock. Therefore, it is dangerous to make any kind of contact with any inside part of this unit.



This symbol alerts the user that important literature concerning the operation and maintenance of this unit has been included. Therefore, it should be read carefully in order to avoid any problems.

WARNING

To reduce the risk of fire or electric shock, do not expose this appliance to rain or moisture.

CAUTION

Use of controls or adjustments or performance of procedures other than herein may result in hazardous radiation exposure.

The set complies with the FCC-Rules, Part 15 and with 21 CFR 1040.10.

IMPORTANT SAFETY INSTRUCTIONS

1. Read these instructions.
2. Keep these instructions.
3. Heed all warnings.
4. Follow all instructions.
5. Do not use this apparatus near water.
6. Clean only with a dry cloth.
7. Do not block any of the ventilation openings. Install in accordance with the manufacturers instructions.
8. Do not install near any heat sources such as radiators, heat registers, stoves, or other apparatus (including amplifiers) that produce heat.
9. Do not defeat the safety purpose of the polarized or grounding-type plug. A polarized plug has two blades with one wider than the other. A grounding type plug has two blades and a third grounding prong. The wide blade or the third prong are provided for your safety. When the provided plug does not fit into your outlet, consult an electrician for replacement of the obsolete outlet.



AC Polarized Plug
10. Protect the power cord from being walked on or pinched, particularly at plugs, convenience receptacles, and the point where they exit from the apparatus.
11. Only use attachments/accessories specified by the manufacturer.
12.  Use only with a cart, stand, tripod, bracket, or table specified by the manufacturer or sold with the apparatus. When a cart is used, use caution when moving the cart/apparatus combination to avoid injury from tip-over.
13. Unplug this apparatus during lightning storms or when unused for long periods of time.
14. Refer all servicing to qualified service personnel. Servicing is required when the apparatus has been damaged in any way, such as if the power-supply cord or plug is damaged, liquid has been spilled or objects have fallen into the apparatus, or when the apparatus has been exposed to rain or moisture, does not operate normally, or has been dropped.
15. Battery usage **CAUTION** –To prevent battery leakage which may result in bodily injury or damage to the unit. Install **all** batteries correctly, + and - as marked on the unit. Do not mix batteries (**old** and **new** or **carbon** and **alkaline**, etc.). Remove batteries when the unit is not used for a long time.
16. Be sure to allow spaces of at least 2.5cm above, behind and on both sides the unit.
17. Do not place the following objects on this unit: A vessel with water in it. If the vessel falls by vibrations and water spills, it may cause damage to the unit, and/or you may get an electric shock.

EL 6475-E002: 01/3

FCC INFORMATION (for US customers only)

1. IMPORTANT NOTICE: DO NOT MODIFY THIS UNIT!

This product, when installed as indicated in the instructions contained in this manual, meets FCC requirements. Modifications not expressly approved by Yamaha may void your authority, granted by the FCC, to use the product.

2. IMPORTANT: When connecting this product to accessories and/or another product use only high quality shielded cables. Cable/s supplied with this product **MUST** be used. Follow all installation instructions. Failure to follow instructions could void your FCC authorization to use this product in the USA.

3. NOTE: This product has been tested and found to comply with the requirements listed in FCC Regulations, Part 15 for Class "B" digital devices. Compliance with these requirements provides a reasonable level of assurance that your use of this product in a residential environment will not result in harmful interference with other electronic devices. This equipment generates/uses radio frequencies and, if not installed and used according to the instructions found in the users manual, may cause interference harmful to the operation of other electronic devices. Compliance with FCC regulations does not guarantee that interference will not occur in all installations. If this product is found to be the source of interference, which can be determined by turning the product "OFF" and "ON", please try to eliminate the problem by using one of the following measures: Relocate either this product or the device that is being affected by the interference.

Utilize power outlets that are on different branch (circuit breaker or fuse) circuits or install AC line filter/s.

In the case of radio or TV interference, relocate/reorient the antenna. If the antenna lead-in is 300 ohm ribbon lead, change the lead-in to coaxial type cable.

If these corrective measures do not produce satisfactory results, please contact the local retailer authorized to distribute this type of product. If you can not locate the appropriate retailer, please contact Yamaha Electronics Corp., 6600 Orangethorpe Ave. Buena Park, CA90622.

The above statements apply **ONLY** to those products distributed by Yamaha Corporation of America or its subsidiaries.

We Want You Listening For A Lifetime

YAMAHA and the Electronic Industries Association's Consumer Electronics Group want you to get the most out of your equipment by playing it at a safe level. One that lets the sound come through loud and clear without annoying blaring or distortion - and, most importantly, without affecting your sensitive hearing.

Since hearing damage from loud sounds is often undetectable until it is too late, YAMAHA and the Electronic Industries Association's Consumer Electronics Group recommend you to avoid prolonged exposure from excessive volume levels.



For Customer Use:

Read carefully the information located at the rear panel of the player and enter below the Serial No. Retain this information for future reference.

Model No. _____

Serial No. _____

CAUTION Visible and invisible radiation when open. Avoid exposure to beam.



FOR CANADIAN CUSTOMERS

To prevent electric shock, match wide blade of plug to wide slot and fully insert.

This Class B digital apparatus complies with Canadian ICES-003.

This digital apparatus does not exceed the Class B limits for radio noise emissions from digital apparatus as set out in the Radio Interference Regulations of the Canadian Department of Communications.

CAUTION

Use of controls or adjustments or performance of procedures other than those specified herein may result in hazardous radiation exposure.

CAUTION: READ THIS BEFORE OPERATING YOUR UNIT.

- 1 To assure the finest performance, please read this manual carefully. Keep it in a safe place for future reference.
- 2 Install this unit in a well ventilated, cool, dry, clean place — away from direct sunlight, heat sources, vibration, dust, moisture, or cold. In a cabinet, allow about 2.5cm (1 inch) of free space all around this unit for adequate ventilation.
- 3 Locate this unit away from other electrical appliances, motors, or transformers to avoid humming sounds.
- 4 Do not expose this unit to sudden temperature changes from cold to hot, nor locate this unit in an environment with high humidity (i.e., a room with a humidifier) to prevent condensation inside this unit, which may cause an electrical shock, fire, damage to this unit, and/or personal injury.
- 5 Avoid installing this unit in a location where foreign objects may fall onto this unit or where this unit may be exposed to liquid dripping or splashing. On the top of this unit, do not place:
 - Other components, as they may cause damage and/or discoloration on the surface of this unit.
 - Burning objects (i.e., candles), as they may cause fire, damage to this unit, and/or personal injury.
 - Containers with liquid in them, as they may fall, spilling the liquid and causing an electrical shock to the user and/or damage to this unit.
- 6 Do not cover this unit with a newspaper, tablecloth, curtain, etc. in order not to obstruct heat radiation. If the temperature inside this unit rises, it may cause fire, damage to this unit, and/or personal injury.
- 7 Do not plug in this unit to a wall outlet until all connections are complete.
- 8 Do not operate this unit upside-down. It may overheat, possibly causing damage.
- 9 Do not use excessive force on switches, knobs and/or cords.
- 10 When disconnecting the power cord from the wall outlet, grasp the plug; do not pull the cord.
- 11 Do not clean this unit with chemical solvents; this might damage the finish. Use a clean, dry cloth.
- 12 Use only the voltage specified on this unit. Using this unit with a higher voltage than specified is dangerous and may cause fire, damage to this unit, and/or personal injury. YAMAHA will not be held responsible for any damage resulting from use of this unit with a voltage other than as specified.
- 13 To prevent damage by lightning, disconnect the power cord from the wall outlet during an electrical storm.
- 14 Do not attempt to modify or fix this unit. Contact qualified YAMAHA service personnel when any service is needed. The cabinet should never be opened for any reason.
- 15 When not planning to use this unit for long periods of time (i.e., vacation), disconnect the AC power plug from the wall outlet.
- 16 Be sure to read the "TROUBLESHOOTING" section on common operating errors before concluding that this unit is faulty.
- 17 Before moving this unit, press STANDBY/ON to set the unit in standby mode, then disconnect the AC power plug from the wall outlet.

WARNING

TO REDUCE THE RISK OF FIRE OR ELECTRIC SHOCK, DO NOT EXPOSE THIS UNIT TO RAIN OR MOISTURE.

NOTE:

Pictures shown maybe different between countries. Never make or change connections with the power switched on.

When playing DTS encoded CDs, excessive noise will be heard from the analog stereo outputs. To avoid possible damage to the audio system, the consumer should take proper precautions when the analog stereo outputs of the player are connected to an amplification system. To enjoy DTS Digital Surround™ playback, an external 5.1-channel DTS Digital Surround™ decoder system must be connected to the digital output of the player.

LASER SAFETY

This unit employs a laser. Due to possible eye injury, only a qualified service person should remove the cover or attempt to service this device.

CAUTION

VISIBLE AND INVISIBLE LASER RADIATION WHEN OPEN. AVOID EXPOSURE TO BEAM (WARNING LOCATION: INSIDE ON LASER COVERS HIELD OR THE BACKPLATE OF SET)

LASER

Type	Semiconductor laser GaAlAs
Wave length	650 nm (DVD) 780 nm (VCD/CD)
Output Power	7 mW (DVD) 10 mW (VCD/CD)
Beam divergence	60 degree

Introduction

Environmental Information	2
Supplied accessories	2
Notes about discs	2
Cleaning discs	2
Symbols Used in this Manual	2

Functional Overview

Front and Rear Panels	3
Remote Control	4

Preparation

General Notes on connections	5
Digital Connections	5
Analog Connections	5
Video Connections	6
S-Video terminal <A>	6
Component Video terminal 	6
Composite Video terminal (1, 2) <C>	6
Inserting batteries into the Remote Control	7
Using the Remote Control	7
NTSC/PAL Conversion	7
Turning on the power	7
Smart Power On/Off	7

Operation

Basic Playback	8
General Operation	8
Video control during playback	8
Audio control during playback	8
Repeat and Shuffle	9
Repeat A-B	9
Disc Resume	9
OSD (On-Screen Display)	9
Zoom	10
Special DVD Features	10
Playing a Title	10
Playing a Chapter	10
Camera Angle	10
Changing the Audio Language and/or format	10
Subtitles	10
Special VCD & SVCD Features	10
Playback Control (PBC)	10
Preview Function	11

Picture CD & MP3 Playback

General Operation	12
MP3 & JPEG Navigator	12
Play Mode	12
Special JPEG Features	13
Function Introduction	13
Preview Function	13
Zoom picture	13
Playback with multi-angles	13
Wipe Effect	13
Special MP3 Features	13
Function Introduction	13
JPEG and MP3 simultaneous playback	13

Setup Menu

Basic Operation	14
General Setup menu	14
Disc Lock	14
Program (not for Picture CD/MP3)	14
OSD language	15
Screen Saver	15
Audio Setup menu	15
Speaker Setup	15
Digital Audio Setup	16
Equalizer (Sound Mode)	16
3D (Reverb Mode)	16
Video Setup menu	17
TV Type	17
TV Display	17
Closed Caption	18
Progressive	18
Picture Setting	18
Password Setup	19
Preference Setup menu	20
Audio language	20
Subtitle language	20
Disc Menu language	20
Parental Control	21
Default Setup	21
MP3/JPEG Navigator	21

Troubleshooting 22

Specifications 23

Maintenance 23

Language Code 24

Introduction

Thank you for purchasing this unit. This Owner's Manual explains the basic operation of this unit.

The region code is 1 for U.S.A and Canada models.



Since it is usual for DVD movies to be released at different times in different regions of the world, all players have region codes and discs can have an optional region code. This unit can play discs containing the identical region code, or mentioned as region "ALL". If you load a disc of a different region code to this unit, you will see the region code notice on the screen. The disc will not playback, and should be unloaded.

Environmental Information

This unit consists of materials which can be recycled and reused if disassembled by a specialised company. Please observe the local regulations regarding the disposal of packaging materials, exhausted batteries and old equipment.

Supplied accessories

- Remote control
- Batteries (two AA size) for remote control
- Audio/Video cable
- Owner's Manual

Notes about discs





- *This unit is designed for use with DVD video, Video CD, Super video CD, Audio CD, CD-R, CD-RW (MP3 Supported), DVD+RW, DVD+R, DVD-R and DVD-RW.*
- *CD-R and CD-RW cannot be played unless finalized.*
- *Some discs cannot be played depending on the recording conditions such as PC environment and application software. The characteristics and condition of the discs; materials, scratches, curvature, and etc, may result in failure.*
- *Be sure to use only CD-R and CD-RW discs made by reliable manufacturers.*
- *Do not use any non standard shaped discs (heart, etc.)*
- *Do not use disc with tape, scals, or paste on it, damage to the unit may result.*
- *Do not use a disc printed on its surface by a commercially available label printer.*

Cleaning discs

- When a disc becomes dirty, clean it with a cleaning cloth. Wipe the disc from the centre out. Do not wipe in a circular motion.
- Do not use solvents such as benzine, thinner, commercially available cleaners, or antistatic spray intended for analog records.

Symbols Used in this Manual

The below symbols appear in some headings and notes with the following meanings:

	– Description refers to playback of DVD-video discs
	– Description refers to playback of Video CDs
	– Description refers to playback of Audio CDs
	– Description refers to playback of Super VCDs

- **Some DVD video discs require specific functions or allow only limited functions during playback.**
- **“×” may appears on the TV screen which means that the function is not available on that specific DVD video disc.**

Manufactured under license from Dolby Laboratories. "Dolby" and the double-D symbol are trademarks of Dolby Laboratories.

"DTS" and "DTS Digital Out" are trademarks of Digital Theater Systems, Inc.

This product incorporates copyright protection technology that is protected by method claims of certain U.S. patents and other intellectual property rights owned by Macrovision Corporation and other rights owners. Use of this copyright protection technology must be authorized by Macrovision Corporation, and is intended for home and other limited viewing uses only unless otherwise authorized by Macrovision Corporation. Reverse engineering or disassembly is prohibited.

Front and Rear Panels

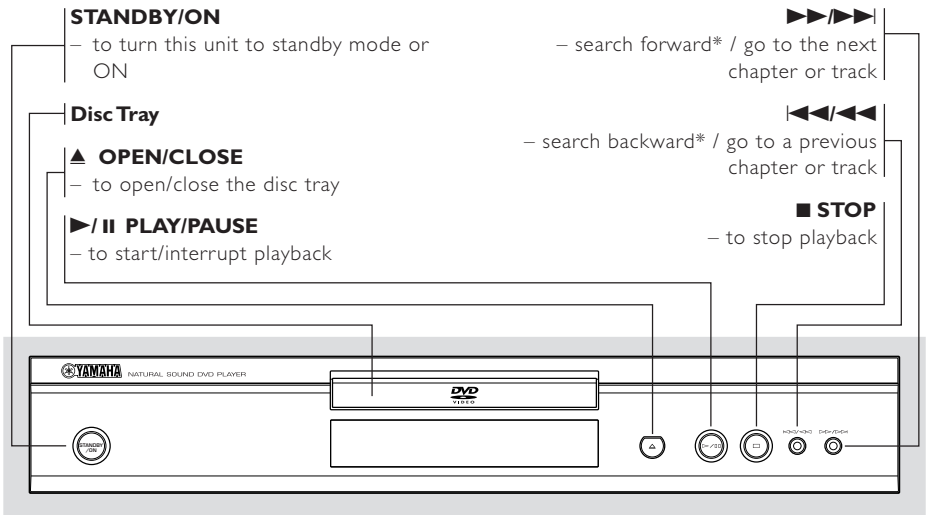

* Press button for about two seconds.

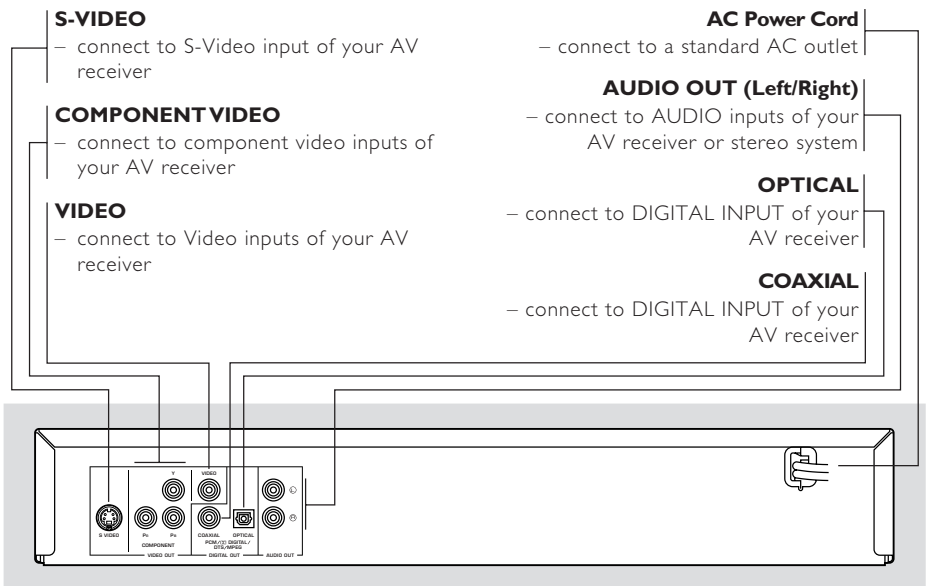

Caution: Do not touch the inner pins of the jacks on the rear panel. Electrostatic discharge may cause permanent damage to the unit.

Functional Overview

Remote Control

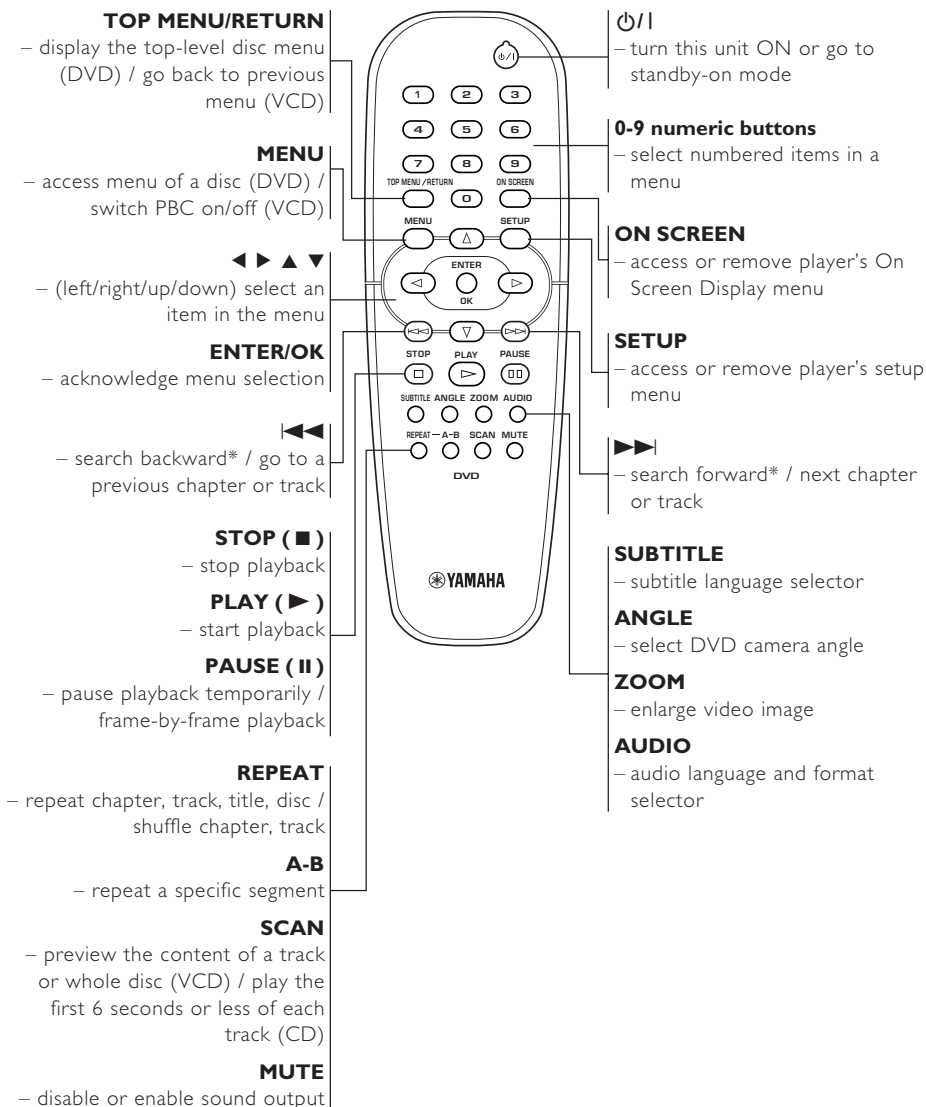

* Press and hold button for about two seconds.

General Notes on connections

Never make or change connections with the power switched on.

- Depending on the equipment you wish to connect, there are various ways you could connect this unit. Possible connections are shown in the following drawings.
- Please refer to the manuals of other equipment as necessary to make the best connections.
- Do not connect this unit via your VCR. The video quality could be distorted by the copy protection system.
- Do not connect this unit's audio out jack to the phono in jack of your audio system.

Digital Connections

This unit has COAXIAL and OPTICAL digital out jacks. Connect one or both of them to your AV receiver equipped with Dolby digital, DTS, or MPEG decoder using each specific cable (separate purchase).

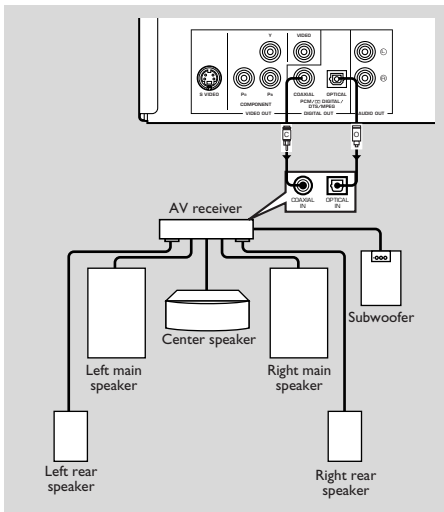

You will need to set this unit's digital output to All (see 'Digital Output').

Note:

– If the audio format of the digital output does not match the capabilities of your receiver, the receiver will produce a strong, distorted sound or no sound at all. Make sure to select the appropriate audio format at menu screen included on the disc. Pressing AUDIO once or more may change not only audio languages but also audio formats, and the selected format appears for several seconds on the status window.

Analog Connections

Use audio/video cable supplied with this unit to connect AUDIO OUT L (left) and R (right) jacks of this unit to corresponding input jacks of your audio equipment such as Stereo amplifier.

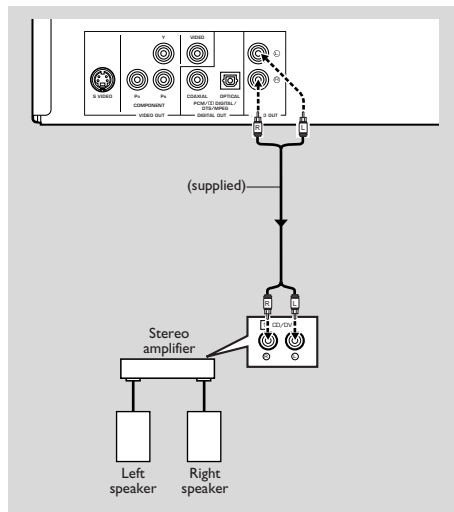

Preparation

Video Connections

If your AV receiver has video output jacks, connect your receiver (and then to your TV) so that you can use one TV for several different video sources (LD, VCR etc.) by simply switching the input source selector of your receiver.

The player has three types of video output jacks. Use one of them in accordance with the input jacks of the equipment to be connected.

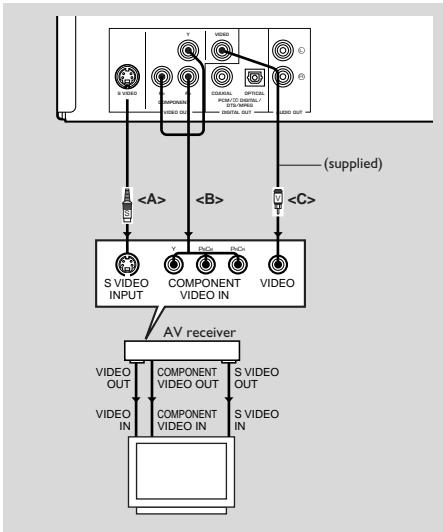

S-Video terminal <A>

S (separate) video connection achieves a clearer picture than composite video connection by separating color and luminance when transmitting signals. Use commercially available S-video cable. Receiver (and TV) with S-video input is required.

Component Video terminal

Component video connection achieves high fidelity in reproducing colors (better performance than S-video connection), separating video signal into luminance (Y, terminal color-coded as green), and color difference (Pb, blue/Pr, red). Use commercially available coaxial cables. Receiver (and TV) with component input is required. Observe the color of each jack when connecting. If your receiver does not have component output jacks, connecting the player's component output directly to your TV's component input can reproduce better video image.

Composite Video terminal (1, 2) <C>

Use audio/video cable supplied with this unit when connecting the player to a TV. VIDEO 1, 2 jacks of VIDEO OUT output the same signal. You can connect one to your receiver's input using supplied Audio/Video cable, and the other to another receiver or a TV.

Inserting batteries into the Remote Control

- 1 Open the battery cover by pressing in the tab, then lift off the cover.
- 2 Insert batteries with the correct polarity as indicated by the + and - symbols inside the battery compartment.
- 3 Close the cover.

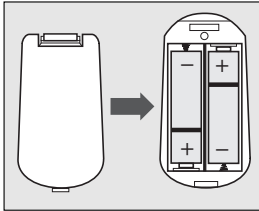

CAUTION!

- Remove batteries if they are exhausted or not to be used for a long time.
- Do not use old and new or different types of batteries in combination.
- Batteries contain chemical substances, so they should be disposed off properly and kept away from children.

Using the Remote Control

- Direct the remote control at the remote sensor of the DVD player.
- Do not drop or give the remote control a shock.
- Do not leave the remote control in extremely hot or humid places.
- Do not spill water or put anything wet on the remote control.

NTSC/PAL Conversion

This player is equipped with a NTSC/PAL conversion feature to convert the video output of the disc to match your TV system. The conversions supported are as below. To activate the conversion, refer to "TV Type":

Disc	Type	Format	Output format		
			Selected mode		
			NTSC	PAL	MULTI
DVD		NTSC	NTSC	PAL	NTSC
		PAL	NTSC	PAL	PAL
VCD		NTSC	NTSC	PAL	NTSC
		PAL	NTSC	PAL	PAL

Notes:

- "Multi" can only be selected when using a TV that has both the NTSC and PAL systems.
- Slight picture distortions may occur due to this conversion. This is normal. Thus, the "Multi" is most suitable for the best picture quality.

Turning on the power

- 1 Connect the AC power cord to the power outlet.
- 2 Turn on the TV and your AV receiver.
- 3 Select the appropriate input source at the AV receiver that was used to connect to this unit. Refer to the equipment owner's manual for detail.
- 4 Turn this unit on.
- 5 Set the TV to the correct Video IN channel. (eg. EXT1, EXT2, AV1, AV2, AUDIO/VIDEO, etc. (Refer to your TV owner's manual for detail)
→ The front display lights up and the default screen appears on the TV.

Smart Power On/Off

When in STOP or NO DISC mode, the DVD player will switch to standby mode after 15 minutes without any operations for saving energy. It is easily reactivated by pressing the POWER or PLAY on the remote control or the STANDBY/ON button on the front panel.

Operation

Basic Playback

- 1 Press STANDBY/ON on the front panel to turn on the DVD player.
- 2 Press ▲ (OPEN/CLOSE) on the front panel to open disc loading tray.
- 3 Place the chosen disc in the tray, with the label facing up.
- 4 Press ▲ (OPEN/CLOSE) again to close the tray.
→ After recognizing this disc, the player begin to playback automatically.

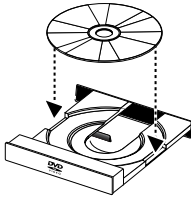

Notes:

- DVDs may have a region code. Your player will not play discs that have a region code different from the region code of your player.
- If 'Disc Lock' is set to LOCK and the disc inserted is not authorized, the 6-digit code must be entered and/or the disc must be authorized (see 'Disc Lock').

General Operation

Note: All instructions set out below refer to the remote control, unless otherwise stated.

Video control during playback

STOP **DVD** **VCD** **CD** **SVCD**

- 1 You can resume the play from the point at which you stopped last time, if you just press STOP once. It will start from the beginning if you press STOP twice to stop playback.

PAUSE/STEP **DVD** **VCD** **CD** **SVCD**

- 1 To get a still picture, press PAUSE during playback.
- 2 To step forward to the next frame picture, press PAUSE again.
- 3 To resume normal playback, press PLAY.

SKIP

- 1 Press ◀◀ or ▶▶ briefly during playback to go to the next chapter/track or to return to the beginning of the current chapter/track respectively.
- 2 Press ◀◀ twice briefly to step back to the previous chapter/track.

- 3 To go directly to any chapter/track, enter the chapter/track number using the numeric buttons and press ENTER/OK.

Note: Long press of the ◀◀ or ▶▶ till switch on backward or forward search.

SEARCH **DVD** **VCD** **CD** **SVCD**

- 1 To search the contents in fast speed, press ▶ or ◀ for fast forward/backward searching.
- 2 Press ▶ or ◀ again to increase the speed for searching.
- 3 Press PLAY to return to normal playback.

Slow Motion

DVD

- 1 To get a slow motion effect during playback, press ▲ or ▼.
- 2 Press ▲ or ▼ again, you can get different playback forward/backward speeds.
- 3 Press PLAY to return to normal play back.

VCD **SVCD**

- 1 To get a slow motion effect during playback, press ▼.
- 2 Press ▼ again, you can get different playback forward speeds.
- 3 Press PLAY to return to normal play back.

Note: The SLOW BACKWARD function is not available for VCD/Super VCD discs.

Audio control during playback

MUTE **DVD** **VCD** **CD** **SVCD**

- 1 Press MUTE to disable the sound output.
- 2 Press MUTE again to deactivate the mute.

Audio channel selection

VCD **CD** **SVCD**

- 1 Super VCD has two stereo audio channels which are used for playing karaoke or the audio language selection. (for instance, you can choose one channel for only the music background of the song while you play the karaoke.)
- 2 Press AUDIO to select the audio channels you want.
- 3 VCD has only one stereo audio channel, you can select STEREO, MONO LEFT, MONO RIGHT or MIX-MONO by pressing AUDIO.
→ Stereo: Output the left and right audio channels of the disc through the left and right audio jacks accordingly.
→ Mono Left: Output the left audio channels of the disc through the left and right audio jacks.

- Mono Right: Output the right audio channels of the disc through the left and right audio jacks.
- MIX-Mono: each of the audio jacks can output the same audio effect as stereo.

Repeat and Shuffle

DVD

- Each time you press REPEAT, the Repeat/Shuffle mode changes as follows;

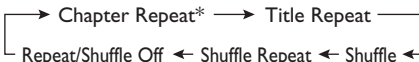

* This feature may not be available with some discs.

VCD CD

With PBC OFF,

- Each time you press REPEAT, the Repeat/Shuffle mode changes as follows;

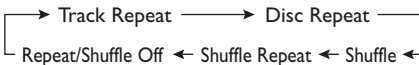

Repeat A-B DVD VCD CD

DVD-Video Discs: repeat a sequence in a title
Video and Audio CDs: repeat a sequence in a track

- 1 Press Repeat A-B at your chosen starting point.
- 2 Press Repeat A-B again at your chosen end point.
→ The repeat sequence begins.
- 3 To exit the sequence, press Repeat A-B.

Disc Resume DVD VCD CD SVCD

This player can resume playback of the last 5 discs, even if the disc was ejected or the power switched off.

- 1 Load one disc, which is one of the last 5 discs.
- 2 Press PLAY when DVD player is recognizing the disc. If the information of this disc has been stored in the memory of DVD player, it will be played back from the stop point last time.

OSD (On-Screen Display)

This function will provide some information about your playing disc on the screen.

- Press ON SCREEN.
The Status window appears on the TV.

Title/Chapter/Track selection DVD VCD

- 1 Press ▲▼ to select "Title" or "Chapter" (DVD) or "Track" (VCD).
- 2 Press ENTER/OK.
- 3 Select a title, chapter or track number using the numeric buttons.

Time Search DVD VCD

- 1 Press ▲▼ to select "TT Time" or "CH Time"(DVD) or "Track Time" or "Disc Time"(VCD).
→ "TT Time" refers to the total time of the current title, and the "CH Time" refers to the total time of the current chapter.
- 2 Press ENTER/OK.
- 3 Enter hours, minutes and seconds from left to right using the numeric buttons. (e.g. 0:34:27)

Audio/Subtitle/Angle DVD

You can change "Audio", "Subtitle" or "Angle" if available on the disc you are playing.

- 1 Press ▲▼ to select "Audio", "Subtitle" or "Angle".
- 2 Press ENTER/OK.
- 3 For Audio and Subtitle,
Press ▲▼ to highlight your selection and press ENTER/OK.

or

For Angle,
Select an angle using the numeric buttons.

Repeat/Time Display DVD VCD

- 1 Press ▲▼ to select "Repeat" or "Time Disp.".
- 2 Press ENTER/OK.
- 3 Press ▲▼ to highlight your selection and press ENTER/OK.

Time display CD

Each time you press ON SCREEN, the time display changes as follows;

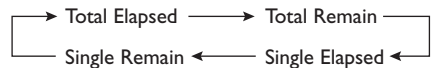

Operation

Zoom

The Zoom function allows you to change the image size.

- 1 Press ZOOM to activate the function.
→ Use ▲▼◀▶ to view other parts of the zoomed picture.
→ Playback will continue.
- 2 Press ZOOM repeatedly to return to the original size.

Special DVD Features

Playing a Title

A DVD disc may have one or more titles. This depends on the content (a movie, video clips, a drama series, etc.) on the disc.

- After you load a disc, information about the content shows on the screen waiting for your selection. You can also press TOP MENU to turn back to the title menu during playback.
→ Press the appropriate numeric buttons or ▲▼◀▶ to highlight your selection.
→ Press ENTER/OK to confirm.

Playing a Chapter

When you have selected a title, it may include one or more chapters.

- Any time you want to watch another chapter during playback, press MENU to turn back to the chapter menu (If disc has chapter menu).
→ Press the appropriate numeric buttons or ▲▼◀▶ on the remote control to highlight your selection.
→ Press ENTER/OK.
→ After a chapter has been selected, you also can press ◀◀ or ▶▶ to make a change.

Camera Angle

Some discs contain scenes which have been shot simultaneously from various angles.

This DVD player allows you to select the desired camera angle.

- Press ANGLE on your remote control.

Note: The function is available only for the DVD discs which have several angles recorded.

Changing the Audio Language and/or format

- Press AUDIO repeatedly to select the different languages.

Note: The function will be activated only if the DVD is recorded with multi-language audio tracks.

Subtitles

- Press SUBTITLE repeatedly to select the different subtitles.

Note: The function will be activated, only if the DVD or Super VCD is recorded with multi-subtitles.

Special VCD & SVCD Features

Playback Control (PBC)

PBC function allows you to enter the index menu which is used to select a track after loading the VCD & SVCD disc.

If you want to activate the function during the playback or after pressing STOP twice,

- 1 Press MENU to set the PBC On.
→ Pay attention to the hint on the screen.
- 2 Use ◀◀ or ▶▶ to select the page you like.
→ If the items of the index menus are numbered, press the appropriate numeric buttons.
→ Press ENTER/OK.
- 3 Press RETURN to enter the index menu during the playback.

Notes:

- *The content of the index menu depends on the disc. Please refer to the disc's instructions for details.*
- *If the disc doesn't include the PBC information, this function will have no effect.*

If you want to skip the index menu and playback directly from the beginning,

- 1 Press MENU to switch off the function.

Preview Function

- Press SCAN to enter previewing menu.
- Press ▲▼ to highlight Track Digest, Disc Interval or Track Interval.
- Press ENTER/OK to open one option.

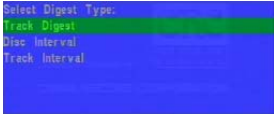

- After you enter the menu of any digest type,
 - To quit preview function: Press ▲▼◀▶ to highlight EXIT and press ENTER/OK.
 - To return to the previewing menu for selecting the other digest type: Press ▲▼◀▶ to highlight MENU and press ENTER/OK.

Note: You can select Track Interval only during playback, with PBC Off.

1 Track Digest

This function will minimize the picture of every track in order to display every six of these tracks on the screen to help you know the content of every track on the disc.



- To choose the desired track, press ▲▼◀▶ to highlight the second line and input your selected track number next to "SELECT".
 - Select the others from the current six by pressing the ◀◀ or ▶▶ to open the previous or next page and press ENTER/OK.

2 Disc Interval

This function is used to divide a disc into six parts by regular intervals and display them on one page to help you preview the whole disc.



- To choose the desired track, press ▲▼◀▶ to highlight the second line and input your numerical selection next to "SELECT" and press ENTER/OK.

3 Track Interval

This function is used to divide a single track into six parts by regular intervals and display them on one page to help you preview the selected track.



- To choose the desired track, please press ▲▼◀▶ to highlight the second line and input your numerical selection next to "SELECT" and press ENTER/OK.

Picture CD & MP3 Playback

This player can playback JPEG format pictures and MP3 files on a personally recorded CD-R/RW disc or commercial CD, and is compatible with Kodak Picture CD.

- Playback pictures or songs one by one automatically.
- Album and track selection.
- Repeat (disc / album / track / picture).
- Select any music or pictures from the disc to playback them together.
- Maximum files numbers in one folder is 500.
- Maximum files Programmable is 100.

General Operation

- If you choose WITH MENU in the Setup Menu (Please refer to the MP3 & JPEG navigator below), the Picture CD/MP3 CD menu will be shown on the screen before playback.

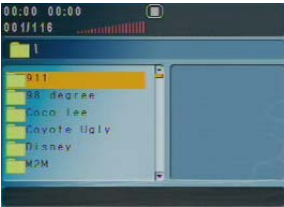

- At any time during JPEG playback, press MENU to return to the menu.
- To open the selected folder, press ENTER/OK.
- The menu shows six files or folders at a time. To move to the next (or previous) page, press ►► (or ◀◀).

MP3 & JPEG Navigator

To select a different playback method, follow the steps below.

- 1 At STOP mode, press SETUP to open the setup menu.
- 2 Press ◀► to highlight PREFERENCE icon.
- 3 Press ▼ to open the PREFERENCE menu.
- 4 Press ▲▼ to highlight the MP3/JPEG NAV menu.
- 5 Press ► to enter the menu.
- 6 Press ▲▼ to highlight the WITHOUT MENU or WITH MENU item.
 - WITHOUT MENU: automatically playback all files in according date sequence.
 - WITH MENU: playback files in the selected folder.
- 7 Press ENTER/OK to confirm your selection.

Play Mode

Auto Playback

If you choose WITHOUT MENU, the DVD player will automatically playback Picture CD/MP3 CD in sequence when it is loaded.

Repeat / Shuffle

- When the Picture CD/MP3 CD menu is shown on the screen, Press REPEAT repeatedly, the button beside PLAY MODE will display different option,
 - Repeat Folder: All files in this folder will be replayed time after time.
 - Shuffle: All files in this folder will be played at random without any repeat.
 - Folder: All files in this folder will be played.
- If you press REPEAT during playback, the option will be displayed on the screen accordingly.
- During Shuffle mode, you can skip tracks by pressing ◀◀ or ►►.

Special JPEG Features

Function Introduction

Picture CD is a disc with a collection of JPEG format pictures, and all extension filenames should end with 'JPG'. The CD can be recorded on any computer, and pictures may be from digital camera or scanner. If the customers prefer, they can make this CD become a Digital Album.

You can choose any general function introduced in General Operation, besides, you also can,

- Display the thumbnails of 12 pictures.
- Zoom the picture.
- Rotate the picture.
- Flip the picture vertically or horizontally.
- Scan pictures by different effects.

Preview Function

This function shows the content of the current folder or the whole disc.

- 1 Press STOP during playback of JPEG pictures. You will see the thumbnails of 12 pictures on the screen.



- 2 Press ◀◀ or ▶▶ to display the other pictures on the next or the previous page.
- 3 Press ▲▼◀▶ to highlight one of them and press ENTER/OK to playback, or, Move the cursor to highlight  on the bottom of the page to start playback from the first picture on the current page.
- 4 Press MENU to go to the Picture CD/MP3 CD menu.

Zoom picture

- During playback, press ZOOM to display the picture with different scales.
- Press ▲▼◀▶ to view the rest of the zoomed picture.

Playback with multi-angles

When displaying one picture on TV screen

- Press ▲▼◀▶ to get different effects.
 - ▲: Flip the picture vertically.
 - ▼: Flip the picture horizontally.
 - ◀: rotate the picture anti-clockwise.
 - ▶: rotate the picture clockwise.

Wipe Effect

- Press ANGLE repeatedly to choose different wipe effects.

Special MP3 Features

Function Introduction

"MP3" stands for "MPEG Audio Layer-3", and is a part of the MPEG standard. A CD can store up to 10 hours of MP3 audio, which is nearly 10 times as much as an Audio CD. Each song is recorded as a file. You can choose any general function introduced in General Operation. You can also choose different playback speeds.

JPEG and MP3 simultaneous playback

- 1 Firstly playback MP3 music according to the instructions introduced in playback Selection.
- 2 Then select a picture to playback. Refer to the instructions introduced in playback Selection.
 - ➔ Now the pictures will be played back in sequence together with MP3 music.
- 3 To quit simultaneous playback, press MENU to return to the Picture CD/MP3 CD menu, then pictures will be stopped. After that, press STOP, then MP3 music will be stopped as well.

Note: In the function of JPEG and MP3 Simultaneous Playback, ◀◀ and ▶▶ are invalid for MP3.

Setup Menu

Basic Operation

- 1 Press SETUP in the STOP mode to enter the Setup Menu.
- 2 Press ENTER/OK to go to the next level submenu or confirm your selection.
- 3 Press ◀▶ to enter the submenu or return to the previous menu.
- 4 Press ▲▼ to highlight the desired menu.
- 5 Press SETUP to quit the setup menu.
→ When you quit the setup menu, the settings will be stored in the player's memory even if the player is switched to power off.

General Setup menu

Some settings need to be made in this menu. They are: "Disc Lock", "Program", "OSD Language" and "Screen Saver". Follow the steps below:

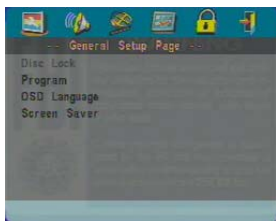

- 1 Press SETUP to enter the setup menu.
- 2 Press ◀▶ to choose the GENERAL SETUP icon .

Disc Lock

When the disc is locked, the player will store its specific code into the memory for future identification. For the next playback, the DVD player will prompt you to enter the password. Then, press ENTER/OK to load the disc.

- 1 Press ▲▼ to highlight "Disc Lock".
- 2 Enter its submenu by pressing ▶.
→ Lock: Lock the disc being played.
→ Unlock: unlock the disc.
- 3 Press ◀ to return to the General Setup Page.

Program (not for Picture CD/MP3)

- 1 press ▲▼ to choose "Program".
- 2 Press ▶ to move the cursor to the field of the submenu to choose the item Input menu.
→ Input menu: Enter the Program item.
- 3 Press ENTER/OK to enter the program page.

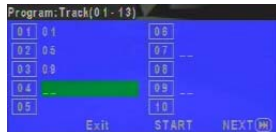

Input your favorite track

- 1 Input valid track number by pressing the numeric buttons.
- 2 Press ▲▼◀▶ to move the cursor to the next selected position.
→ If the track number is more than ten, press ▶▶ to open the next page and go on programming, or press ▲▼◀▶ to highlight NEXT button, and then press ENTER/OK.
- 3 Repeat this steps to input another track number until the whole program is completed.

Remove a track

- 1 Press ▲▼◀▶ to move the cursor to the track you want to remove.
- 2 Press ENTER/OK or PLAY to remove this track from the program menu.

Playback tracks

When programming is completed,

- 1 Press ▲▼◀▶ to move the cursor to the START button.
- 2 Press ENTER/OK.
→ DVD player will playback the selected tracks under the programmed sequence.

Quit the program playback

In the Program menu,

- 1 Press ▲▼◀▶ to move the cursor to the EXIT button.
- 2 Press ENTER/OK to quit this menu.

Stop the program playback

- During playback of the programmed tracks, press STOP. Then after you press PLAY, the DVD player will resume normal playback.

Repeat the program playback

- During playback of the programmed tracks, press REPEAT. The programed tracks can be played again.

Note: If you select Shuffle mode by pressing REPEAT several times, the DVD player cancels program playback.

OSD language

This option is to select a language for information displayed on TV screen.

- 1 Press ▲▼ to highlight "OSD Language" in the General Setup menu.
- 2 Enter its submenu by pressing ►.
- 3 Move the cursor by pressing ▲▼ to highlight the selected language.
- 4 Press ENTER/OK to confirm.
- 5 Press ◀ to return to the General Setup Page.

Screen Saver

This function is used to turn the screen saver on or off.

- 1 Press ▲▼ to highlight "Screen Saver" in the General Setup menu.
- 2 Enter its submenu by pressing ►.
- 3 Move the cursor by pressing ▲▼ to highlight the selected item.
 - On: In STOP or No DISC mode, if no actions are performed within 5~6 minutes, the screen saver will be activated.
 - Off: Screen saver is disabled.
- 4 Press ENTER/OK.
- 5 Press ◀ to return to the General Setup Page.

Audio Setup menu

There are items included in Audio Setup Page such as "Speaker Setup", "Digital Audio Setup", "Equalizer" and "3D".



- 1 Press SETUP to enter the setup menu.
- 2 Press ◀▶ to choose the AUDIO SETUP icon .

Speaker Setup

This menu contains setup options for your analog audio output, such as "Downmix", "D.R.C." (Dynamic Range Compression) etc. which makes the setup system reproduce high quality surround sound.

Downmix

- 1 Press ▲▼ to highlight the "Downmix".
- 2 Enter its submenu by pressing ►.
- 3 Move the cursor by pressing ▲▼ to highlight the selected item.
 - LT/RT
 - This option should be used only if your DVD player is connected to a Dolby Prologic decoder.
 - Stereo
 - This option will downmix Dolby Digital signals directly into analogue stereo from L/R jacks.
 - Virtual Surround
 - This option will reproduce the surround channels virtually.
- 4 Press ENTER/OK.
- 5 Press ◀ to return to the Audio Setup Page.

D.R.C. (Dynamic Range Compression)

The DVD player will compress the dynamic range of its sound output for late-night listening.

- 1 Press ▲▼ to highlight "D.R.C.".
- 2 Enter its submenu by pressing ►.
- 3 Move the cursor by pressing ▲▼ to highlight the selected item.
 - On: Enable D.R.C.
 - Off: Disable D.R.C.
- 4 Press ENTER/OK.
- 5 Press ◀ to return to the Audio Setup Page.

Setup Menu

Digital Audio Setup

In this menu, you can set up the digital audio output signal from the digital jacks, such as coaxial etc.

Digital Output

- 1 Press ▲▼ to highlight Digital Output.
- 2 Enter its submenu by pressing ►.
- 3 Press ▲▼ to highlight the selected item.
→ All: Original digital signals output. In this mode, all audio settings except MUTE are invalid.
→ PCM Only: If your receiver is PCM-compatible, or your receiver can not decode MPEG-2, Dolby Digital, or DTS audio, choose this option.
- 4 Press ENTER/OK.
- 5 Press ◀ and return to the Audio Setup Page.

Note: If Digital Output is set to All, all audio settings except MUTE are invalid.

LPCM Output

In this menu, you can select PCM digital output between 48kHz and 96kHz.

- 1 Press ▲▼ to highlight the LPCM Output.
- 2 Enter its submenu by pressing ►.
- 3 Move the cursor by pressing ▲▼ to highlight the selected item.
→ 48K: 96kHz (if available on disc) PCM data stream will be converted to 48kHz.
→ 96K: If the 96kHz disc is copy protected, the digital output will be muted to comply with the standards.
- 4 Press ENTER/OK.
- 5 Press ◀ to return to the Audio Setup Page.

Equalizer (Sound Mode)

The "Equalizer" allow you to select from various preset modes that control the frequency bands of sound to optimize certain musical styles. It greatly enhances the excitement and enjoyment of your favourite music.

- 1 Press ▲▼ to highlight the "Equalizer".
- 2 Enter its submenu "Sound Mode" by pressing ►.
- 3 Press ►.
- 4 Move the cursor by pressing ▲▼ to highlight the selected item.
→ None: Playback the disc under the original sound effect.
- 5 Press ENTER/OK.
- 6 Press ◀ to return to the Audio Setup Page.

3D (Reverb Mode)

The "3D" can simulate the echoes and frequency response of some particular places so as to make you feel like personally on the place.

- 1 Press ▲▼ to highlight the "3D".
- 2 Enter its submenu "Reverb Mode" by pressing ►.
- 3 Press ►.
- 4 Move the cursor by pressing ▲▼ to highlight the selected item.
→ Off: Playback the disc under the original sound effect.
- 5 Press ENTER/OK.
- 6 Press ◀ to return to the Audio Setup Page.

Video Setup menu

There are items included in Video Setup menu such as "TV Type", "TV Display", "Closed Caption", "Progressive" and "Picture Setting".

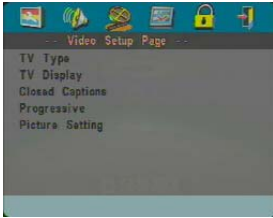

- 1 Press **SETUP** to enter the setup menu.
- 2 Press **◀▶** to choose the VIDEO SETUP icon .

TV Type

Before viewing the DVD or VCD, ensure that the PAL or NTSC setting of the system matches your TV set.

- 1 Press **▲▼** to highlight "TV Type" in the Video Setup menu.
- 2 Enter its submenu by pressing **▶**.
- 3 Move the cursor by pressing **▲▼** to highlight one option.
- 4 Press **ENTER/OK**.
- 5 Press **◀** to return to the Video Setup Page.

Note: Choosing NTSC item indicates that the player will output NTSC signals, Similarly, you can get PAL signals by choosing the PAL option. The option Multi means video output depends on the format of the DVD or VCD discs.

TV Display

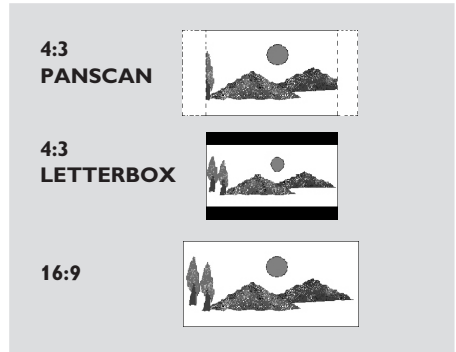

Select the aspect ratio of the TV to be connected.

4:3 PANSCAN → when you connect a normal TV to the DVD player. Displays the wide picture on the whole TV screen with a portion automatically cut off.

4:3 LETTERBOX → when you connect a normal TV to the DVD player. Displays a wide picture with bands displayed on the upper and lower portions of the TV screen.

16:9 → when you connect a wide-screen TV to the DVD player.

Set up the item as follows,

- 1 Press **▲▼** to highlight the "TV Display" option in the Video Setup menu.
- 2 Enter its submenu by pressing **▶**.
- 3 Move the cursor by pressing **▲▼** to highlight the selected item.
- 4 Press **ENTER/OK**.
- 5 Press **◀** to return to the Video Setup Page.

Setup Menu

Closed Caption

Closed captions are data that are hidden in the video signal on specific discs, invisible without a special decoder. The difference between subtitles and captions is that subtitles are intended for hearing persons and captions are for the hearing impaired. Subtitles rarely show all of the audio. For example, captions show sound effects (e.g., "phone ringing" and "footsteps"), while subtitles don't.

Before you select this function, please ensure that the disc contains closed captions information and your TV set also has this function.

- 1 Press **▲▼** to highlight "Closed Caption" in the Video Setup menu.
- 2 Enter its submenu by pressing **▶**.
- 3 Move the cursor by pressing **▲▼** to highlight one option.
→ On: Enable Closed Caption.
→ Off: Disable Closed Caption.
- 4 Press **ENTER/OK**.
- 5 Press **◀** to return to the Video Setup Page.

Progressive

This player's COMPONENT video jack can output progressive signals to a progressive signal compatible TV for an extra high-quality picture.

- 1 Press **▲▼** to highlight "Progressive".
 - 2 Enter its submenu by pressing **▶**.
 - 3 Move the cursor by pressing **▲▼** to highlight one option.
→ On: Enable Progressive.
→ Off: Disable Progressive.
- If you select "On", the player prompts you to confirm your selection.
- 4 Press **ENTER/OK**.
 - 5 Press **◀** to return to the Video Setup Page.

Notes on activating Progressive:

- Ensure that your TV has progressive scan.
 - Connect with YPbPr video cable.
 - When the Progressive is active, the VIDEO (CVBS) and S VIDEO jacks do not output video signals.
 - If there is no picture, wait 15 seconds for auto recover or deactivate Progressive manually.
- 1 Open the disc tray by pressing **▲** (OPEN/CLOSE) on the front panel.
 - 2 Press **◀**.
 - 3 Press **MUTE**.

CONSUMERS SHOULD NOTE THAT NOT ALL HIGH DEFINITION TELEVISION SETS ARE FULLY COMPATIBLE WITH THIS PRODUCT AND MAY CAUSE ARTIFACTS TO BE DISPLAYED IN THE PICTURE. IN CASE OF 525 PROGRESSIVE SCAN PICTURE PROBLEMS, IT IS RECOMMENDED THAT THE USER SWITCH THE CONNECTION TO THE "STANDARD DEFINITION" OUTPUT. IF THERE ARE QUESTIONS REGARDING OUR VIDEO MONITOR COMPATIBILITY WITH THIS MODEL 525P DVD PLAYER, PLEASE CONTACT OUR CUSTOMER SERVICE CENTER.

This unit is compatible with the complete line of YAMAHA products, including the projectors DPX-1, DPX-1000, LPX-500 and the plasma monitor PDM-1.

Picture Setting

In this menu, you can personalize your picture color by adjusting brightness, contrast, tint and color (saturation).

- 1 Press **▲▼** to highlight "Picture Setting" in the Video Setup menu.
- 2 Press **▶** to open its submenu.

Brightness

- 1 Press **▲▼** to highlight "Brightness".
- 2 Press **▶** to open the level bar.



- 3 Press **◀▶** to increase and decrease the brightness level.
- 4 Press **ENTER/OK** to return to the Picture Setting menu.

Contrast

- 1 Press **▲▼** to highlight "Contrast".
- 2 Press **▶** to open the level bar.
- 3 Press **◀▶** to increase and decrease the contrast level.
- 4 Press **ENTER/OK** to return to the Picture Setting menu.

Tint

- 1 Press **▲▼** to highlight "Tint".
- 2 Press **▶** to open the level bar.
- 3 Press **◀▶** to increase and decrease the tint level.
- 4 Press **ENTER/OK** to return to the Picture Setting menu.

Color (saturation)

- 1 Press ▲▼ to highlight "Color".
- 2 Press ► to open the level bar.
- 3 Press ◀▶ to increase and decrease the color level.
- 4 Press ENTER/OK to return to the Picture Setting menu.

Password Setup

This item is used for the parental control and disc lock. Enter your six digit password when a hint is displayed on the screen.



- 1 Press SETUP to enter the setup menu.
- 2 Press ◀▶ to choose the PASSWORD icon .
- 3 Press ▼ to highlight "Password".
- 4 Press ► to highlight "Change".
- 5 Press ENTER/OK to open the Password Change Page.



- 6 Press ▼ to repeatedly until the player prompt you to enter the old password.
- 7 Enter the current 6 digit code.
- 8 If successful, the player will prompt for a new one.
- 9 After that, enter the new password again to reconfirm.
- 10 Press ENTER/OK to return to the Password Setup Page.

Notes:

- You can change the setup of parental control and load a locked disc with a valid password being entered.
- If you forget your password, you can enter the default password 842100, then you can input your password after logging on.

Setup Menu

Preference Setup menu

There are options included in this menu such as "Audio", "Subtitle", "Disc Menu", "Parental", "Default" and "MP3/JPEG NAV".

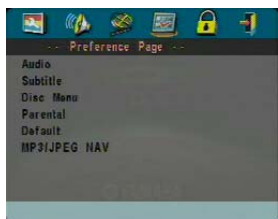

- 1 Press STOP twice.
- 2 Press SETUP to enter the setup menu.
- 3 Press ◀▶ to choose the PREFERENCE icon .

Audio language

DVD discs are available with multiple audio languages. Use this option to select the preferred default audio language.

- 1 Press ▲▼ to highlight "Audio".
- 2 Enter the submenu by pressing ▶.
- 3 Move the cursor by pressing ▲▼ to highlight the selected option.
→ If you want to choose other languages, please refer to the instructions on the next page.
- 4 Press ENTER/OK.
- 5 Press ◀ to return to the Preference Page.

Note: Your DVD disc may not include the audio language which you set in the AUDIO menu. If so, the player will use another audio language instead.

Subtitle language

DVD discs are available with multi-subtitle languages. Use this option to select the preferred default subtitle language.

- 1 Press ▲▼ to highlight "Subtitle".
- 2 Enter the submenu by pressing ▶.
- 3 Move the cursor by pressing ▲▼ to highlight the selected option.
→ If you want to choose other languages, please refer to the following instructions.
- 4 Press ENTER/OK.
- 5 Press ◀ to return to the Preference Page.

Note: Your DVD disc may not include the subtitle which you set in the SUBTITLE menu. If so, the player will use another subtitle language instead.

Disc Menu language

DVD discs are available with multiple disc menu languages. This option is used to select the default disc menu language.

- 1 Press ▲▼ to highlight "Disc Menu".
- 2 Enter the submenu by pressing ▶.
- 3 Move the cursor by pressing ▲▼ to highlight the selected item.
→ If you want to choose other languages, please refer to the following instructions.
- 4 Press ENTER/OK.
- 5 Press ◀ to return to the Preference Page.

Note: If your DVD disc doesn't include the disc menu language you have set, the player will use another recorded language instead.

If you choose Others in Audio, Subtitle or Disc Menu menu,

You can select other languages. Please do as follows,

- 1 Move the cursor by pressing ▲▼ to highlight "Others".
- 2 Press ENTER/OK.
→ The DVD player will prompt you to enter a language code (Four digits).
- 3 Input a language code by pressing numeric buttons.
→ Please look up the preferred language code in the chapter LANGUAGE CODE, which can be found at the end of this manual.
- 4 Press ENTER/OK.

Parental Control

Movies on DVDs may contain scenes which are not suitable for children. Therefore, discs may contain 'Parental Control' information which applies to the complete disc or to certain scenes on the disc. These scenes are rated from 1 to 8, and alternative, more suitable scenes are available on the disc. Ratings are country dependent. The 'Parental Control' feature allows you to prevent discs from being played by your children or to have certain discs played with alternative scenes.

- VCD, SVCD, CD have no level indication, so parental control function has no effect on those kinds of discs. This applies to most illegal DVD discs.
- You can follow the steps below to setup the parental control:
 - 1 Press ▲▼ to highlight "Parental".
 - 2 Move to its submenu by pressing ►.
 - 3 Then use ▲▼ to highlight a rating for the disc inserted.
 - 4 Press ENTER/OK to confirm, then press ◀ to return to the Preference Page.

No Parental Control

Parental Control is not activated. The Disc will be played in full.

- 1 Select 8 ADULT item.
- 2 Press ENTER/OK.

Ratings 1 to 7:

- 3 Some discs contain scenes which are not suitable for children. All scenes with a rating higher than you set will be skipped during playback. However if the disc contains alternate scenes, these will play automatically. If not, the playback will stop and the six digits code will need to be entered again.

Default Setup

If problems occur while setting up the DVD player, the "Default" function can be used to reset all options to the factory defaults and all your personal settings will be erased.

- 1 Press ▲▼ to highlight "Default".
- 2 Highlight RESET by pressing ►.
- 3 Press ENTER/OK.

Note: When this function is activated, all setups will be reset to factory defaults.

MP3/JPEG Navigator

This menu allows you to select alternate settings when you playback picture CD and MP3 CD.

- 1 Press ▲▼ to highlight MP3/JPEG NAV.
- 2 Press ► to enter the submenu.
- 3 Press ▲▼ to highlight WITHOUT MENU or WITH MENU.
 - WITHOUT MENU: playback all pictures or MP3 music in sequence automatically.
 - WITH MENU: playback pictures or MP3 music in the selected folder.
- 4 Press ENTER/OK to confirm your selection.

Troubleshooting

Refer to the chart below when this unit does not function properly. If the problem you are experiencing is not listed below or if the instruction below does not help, set this unit to the standby mode, disconnect the power cord, and contact the nearest authorized YAMAHA dealer or service center.

Problem	Solution
No power	<ul style="list-style-type: none">– Check if the AC power cord is properly connected.
No picture	<ul style="list-style-type: none">– Check if the TV is switched on.– Check the video connection.– If you did not use Progressive Scan connections (using the Y Pa Pr jacks on the DVD Player) and you do not have a picture at the TV, please follow the steps below to turn off Progressive Scan:<ol style="list-style-type: none">1. Press ▲ (OPEN/CLOSE) to open the disc tray.2. Press ►.3. Then press MUTE to deactivate the Progressive. The DVD Player will reset itself to Component/Interlaced video. The disc tray will closed automatically to let you know it has reset itself.
Distorted picture	<ul style="list-style-type: none">– The disc is badly scratched or dirty.– Sometimes a small amount of picture distortion may appear. This is not a malfunction.
Completely distorted picture or black/white picture with DVD or Video CD	<ul style="list-style-type: none">– Make sure the NTSC/PAL setting at the DVD player matches the video signal of your television. (See NTSC/PAL CONVERSION)
No sound or distorted sound	<ul style="list-style-type: none">– Adjust the volume.– Check that the speakers are connected correctly.
No audio at digital output	<ul style="list-style-type: none">– Check the digital connections.– Check if your receiver can decode MPEG-2 or DTS and if not, please make sure the digital output is set to PCM.– Check if the audio format of the selected audio language matches your receiver capabilities.
Disc can't be played	<ul style="list-style-type: none">– The DVD+R/DVD+RW/DVD-R/DVD-RW/CD-R/CD-RW must be finalized.– Ensure the disc label is facing up.– Check if the disc is defective by trying another disc.– If you have recorded this particular Picture CD or MP3 CD yourself, please ensure that your disc contains at least about 6~10 pictures or 3~5MP3 music tracks before using it with the player.
No return to start-up screen when disc is removed	<ul style="list-style-type: none">– Reset the unit by switching the player off, then on again.
The player does not respond to the remote control	<ul style="list-style-type: none">– Aim the remote control directly at the sensor on the front of the player.– Reduce the distance to the player.– Replace the batteries in the remote control.– Insert the batteries with their polarities (+/- signs) as indicated.
Buttons do not work	<ul style="list-style-type: none">– In order to completely reset the player, unplug the AC cord from the AC outlet.
Player does not respond to some operating commands during playback	<ul style="list-style-type: none">– Operations may not be permitted by the disc. Refer to the instructions of the disc.
DVD Video player cannot read CDs/DVDs	<ul style="list-style-type: none">– Use a commonly available cleaning CD/DVD to clean the lens before sending the DVD Video player for repair.

Specifications

PLAYBACK SYSTEM

DVD Video
Video CD & SVCD
CD
PICTURE CD
CD-R, CD-RW
DVD+R, DVD+RW
DVD-R, DVD-RW

VIDEO PERFORMANCE

Video (CVBS) Output 1 Vpp into 75 ohm
S-Video output Y: 1 Vpp into 75 ohm
C: 0.3 Vpp into 75 ohm
Component video output Y: 1 Vpp into 75 ohm
Pb/Cb Pr/Cr: 0.7 Vpp into 75 ohm
Black Level Shift On/Off
Video Shift Left/Right

AUDIO FORMAT

Digital Mpeg/ AC-3/ DTS Compressed Digital
PCM 16, 20, 24 bits
fs, 44.1, 48, 96 kHz
MP3(ISO 9660) 24, 32, 56, 64, 96, 128, 256 kbps
fs, 16, 22.05, 24, 32, 44.1, 48 kHz
Analog Sound Stereo

AUDIO PERFORMANCE

DA Converter 24bit
Signal-Noise (1 kHz) 105dB
Dynamic range (1 kHz) 100dB
DVD fs 96 kHz 2Hz- 44kHz
fs 48 kHz 2Hz- 22kHz
SVCD fs 48 kHz 2Hz- 22kHz
fs 44.1kHz 2Hz- 20kHz
CD/VCD fs 44.1kHz 2Hz- 20kHz
Distortion and Noise (1 kHz) 0.003%

TV STANDARD (PAL/50Hz) (NTSC/60Hz)

Number of lines 625 525
Playback Multistandard (PAL/NTSC)

CONNECTIONS

Y Output Cinch (green)
Pb/Cb Output Cinch (blue)
Pr/Cr Output Cinch (red)
S-Video Output Mini DIN, 4 pins
Video Output Cinch
Audio Output (L+R) Cinch
Digital Output 1 coaxial, 1 optical
IEC958 for CDDA / LPCM/
MPEG1
IEC1937 for MPEG 2, Dolby
Digital and DTS

CABINET

Dimensions (w x d x h) 435 x 302 x 75 mm
Weight Approx. 2.8 Kg

POWER SUPPLY

Power inlet 120V, 60Hz
Power usage Approx. 12W
Power usage standby < 1W

Specifications subject to change without prior notice.

Maintenance

Cleaning the Cabinet

- Use a soft cloth slightly moistened with a mild detergent solution. Do not use a solution containing alcohol, spirits, ammonia or abrasives.

Cleaning Discs

- When a disc becomes dirty, clean it with a cleaning cloth. Wipe the disc from the center out. Do not wipe in a circular motion.
- Do not use solvents such as benzene, thinner, commercially available cleaners, or antistatic spray intended for analog records.

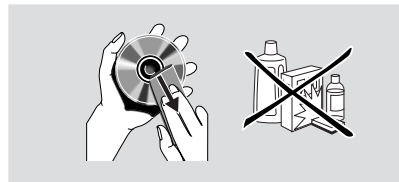

Language Code

These pages can be used to select other languages. This does not affect the options in “Audio”, “Subtitle” or “Disc Menu”.

Abkhazian	6566	German	6869
Afar	6565	Gikuyu; Kikuyu	7573
Afrikaans	6570	Greek,	6976
Albanian	8381	Guarani	7178
Amharic	6577	Gujarati	7185
Arabic	6582	Hausa	7265
Armenian	7289	Hebrew	7269
Assamese	6583	Herero	7290
Avestan	6569	Hindi	7273
Aymara	6589	Hiri Motu	7279
Azerbaijani	6590	Hungarian	7285
Bashkir	6665	Icelandic	7383
Basque	6985	Ido	7379
Belarusian	6669	Indonesian	7368
Bengali	6678	Interlingua (International)	7365
Bihari	6672	Interlingue	7369
Bislama	6673	Inuktitut	7385
Bokmål, Norwegian	7866	Inupiaq	7375
Bosnian	6683	Irish	7165
Breton	6682	Italian	7384
Bulgarian	6671	Japanese	7465
Burmese	7789	Javanese	7486
Castilian, Spanish	6983	Kalaallisut	7576
Catalan	6765	Kannada	7578
Chamorro	6772	Kashmiri	7583
Chechen	6769	Kazakh	7575
Chewa; Chichewa; Nyanja	7889	Khmer	7577
Chichewa; Chewa; Nyanja	7889	Kikuyu; Gikuyu	7573
Chinese	9072	Kinyarwanda	8287
Chuang; Zhuang	9065	Kirghiz	7589
Church Slavic; Slavonic;	6785	Komi	7586
Church Slavonic; Church	6785	Korean	7579
Chuvash	6786	Kuanyama; Kwanyama	7574
Cornish	7587	Kurdish	7585
Corsican	6779	Kwanyama; Kuanyama	7574
Croatian	7282	Lao	7679
Czech	6783	Latin	7665
Danish	6865	Latvian	7686
Dutch	7876	Letzeburgesch;	7666
Dzongkha	6890	Limburgan; Limburger;	7673
English	6978	Limburger; Limburger;	7673
Esperanto	6979	Limburgish; Limburger;	7673
Estonian	6984	Lingala	7678
Faroese	7079	Lithuanian	7684
Fijian	7074	Luxembourgish;	7666
Finnish	7073	Macedonian	7775
French	7082	Malagasy	7771
Frisian	7089	Malay	7783
Gaelic; Scottish Gaelic	7168	Malayalam	7776
Gallegan	7176	Maltese	7784
Georgian	7565	Manx	7186

These pages can be used to select other languages. This does not affect the options in “Audio”, “Subtitle” or “Disc Menu”.

Maori	7773	Sotho, Southern	8384
Marathi	7782	South Ndebele	7882
Marshallese	7772	Spanish; Castilian	6983
Moldavian	7779	Sundanese	8385
Mongolian	7778	Swahili	8387
Nauru	7865	Swati	8383
Navaho, Navajo	7886	Swedish	8386
Navajo; Navaho	7886	Tagalog	8476
Ndebele, North	7868	Tahitian	8489
Ndebele, South	7882	Tajik	8471
Ndonga	7871	Tamil	8465
Nepali	7869	Tatar	8484
Northern Sami	8369	Telugu	8469
North Ndebele	7868	Thai	8472
Norwegian	7879	Tibetan	6679
Norwegian Bokmål; Bokmål,	7866	Tigrinya	8473
Norwegian Nynorsk;	7878	Tonga (Tonga Islands)	8479
Nyanja; Chichewa; Chewa	7889	Tsonga	8483
Nynorsk, Norwegian;	7878	Tswana	8478
Occitan (post 1500); Proven	7967	Turkish	8482
Old Bulgarian; Old Slavonic;	6785	Turkmen	8475
Old Church Slavonic; Old	6785	Twi	8487
Old Slavonic; Church	6785	Uighur	8571
Oriya	7982	Ukrainian	8575
Oromo	7977	Urdu	8582
Ossetian; Ossetic	7983	Uzbek	8590
Ossetic; Ossetian	7983	Vietnamese	8673
Pali	8073	Volapük	8679
Panjabi	8065	Walloon	8765
Persian	7065	Welsh	6789
Polish	8076	Wolof	8779
Portuguese	8084	Xhosa	8872
Provençal; Occitan (post)	7967	Yiddish	8973
Pushto	8083	Yoruba	8979
Quechua	8185	Zhuang; Chuang	9065
Raeto-Romance	8277	Zulu	9085
Romanian	8279		
Rundi	8278		
Russian	8285		
Samoan	8377		
Sango	8371		
Sanskrit	8365		
Sardinian	8367		
Scottish Gaelic; Gaelic	7168		
Serbian	8382		
Shona	8378		
Sindhi	8368		
Sinhalese	8373		
Slovak	8375		
Slovenian	8376		
Somali	8379		



YAMAHA ELECTRONICS CORPORATION, USA 6660 ORANGETHORPE AVE., BUENA PARK, CALIF. 90620, U.S.A.
YAMAHA CANADA MUSIC LTD. 135 MILNER AVE., SCARBOROUGH, ONTARIO M1S 3R1, CANADA
YAMAHA ELECTRONIK EUROPA G.m.b.H. SIEMENSSTR. 22-34, 25462 RELINGEN BEI HAMBURG, F.R. OF GERMANY
YAMAHA ELECTRONIQUE FRANCE S.A. RUE AMBROISE CROIZAT BP70 CROISSY-BEAUBOURG 77312 MARNE-LA-VALLEE CEDEX02, FRANCE
YAMAHA ELECTRONICS (UK) LTD. YAMAHA HOUSE, 200 RICKMANSWORTH ROAD WATFORD, HERTS WD18 7GQ, ENGLAND
YAMAHA SCANDINAVIA A.B. J A WETTERGRENS GATA 1, BOX 30053, 400 43 VÄSTRA FRÖLUNDA, SWEDEN
YAMAHA MUSIC AUSTRALIA PTY, LTD. 17-33 MARKET ST., SOUTH MELBOURNE, 3205 VIC., AUSTRALIA

YAMAHA CORPORATION

Free Manuals Download Website

<http://myh66.com>

<http://usermanuals.us>

<http://www.somanuals.com>

<http://www.4manuals.cc>

<http://www.manual-lib.com>

<http://www.404manual.com>

<http://www.luxmanual.com>

<http://aubethermostatmanual.com>

Golf course search by state

<http://golfingnear.com>

Email search by domain

<http://emailbydomain.com>

Auto manuals search

<http://auto.somanuals.com>

TV manuals search

<http://tv.somanuals.com>