



# *HTR-5920*

---

*AV Receiver*

*Ampli-tuner audio-vidéo*

OWNER'S MANUAL  
MODE D'EMPLOI

# IMPORTANT SAFETY INSTRUCTIONS

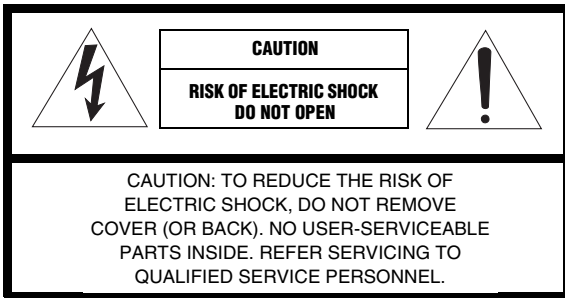

## • Explanation of Graphical Symbols



The lightning flash with arrowhead symbol, within an equilateral triangle, is intended to alert you to the presence of uninsulated “dangerous voltage” within the product’s enclosure that may be of sufficient magnitude to constitute a risk of electric shock to persons.



The exclamation point within an equilateral triangle is intended to alert you to the presence of important operating and maintenance (servicing) instructions in the literature accompanying the appliance.

- 1 Read Instructions – All the safety and operating instructions should be read before the product is operated.
- 2 Retain Instructions – The safety and operating instructions should be retained for future reference.
- 3 Heed Warnings – All warnings on the product and in the operating instructions should be adhered to.
- 4 Follow Instructions – All operating and use instructions should be followed.
- 5 Cleaning – Unplug this product from the wall outlet before cleaning. Do not use liquid cleaners or aerosol cleaners.
- 6 Attachments – Do not use attachments not recommended by the product manufacturer as they may cause hazards.
- 7 Water and Moisture – Do not use this product near water – for example, near a bath tub, wash bowl, kitchen sink, or laundry tub; in a wet basement; or near a swimming pool; and the like.
- 8 Accessories – Do not place this product on an unstable cart, stand, tripod, bracket, or table. The product may fall, causing serious injury to a child or adult, and serious damage to the product. Use only with a cart, stand, tripod, bracket, or table recommended by the manufacturer, or sold with the product. Any mounting of the product should follow the manufacturer’s instructions, and should use a mounting accessory recommended by the manufacturer.
- 9 A product and cart combination should be moved with care. Quick stops, excessive force, and uneven surfaces may cause the product and cart combination to overturn.



- 10 Ventilation – Slots and openings in the cabinet are provided for ventilation and to ensure reliable operation of the product and to protect it from overheating, and these openings must not be blocked or covered. The openings should never be blocked by placing the product on a bed, sofa, rug, or other similar surface. This product should not be placed in a built-in installation such as a bookcase or rack unless proper ventilation is provided or the manufacturer’s instructions have been adhered to.
- 11 Power Sources – This product should be operated only from the type of power source indicated on the marking label. If you are not sure of the type of power supply to your home, consult your product dealer or local power company. For products intended to operate from battery power, or other sources, refer to the operating instructions.
- 12 Grounding or Polarization – This product may be equipped with a polarized alternating current line plug (a plug having one blade wider than the other). This plug will fit into the power outlet only one way. This is a safety feature. If you are unable to insert the plug fully into the outlet, try reversing the plug. If the plug should still fail to fit, contact your electrician to replace your obsolete outlet. Do not defeat the safety purpose of the polarized plug.
- 13 Power-Cord Protection – Power-supply cords should be routed so that they are not likely to be walked on or pinched by items placed upon or against them, paying particular attention to cords at plugs, convenience receptacles, and the point where they exit from the product.
- 14 Lightning – For added protection for this product during a lightning storm, or when it is left unattended and unused for long periods of time, unplug it from the wall outlet and disconnect the antenna or cable system. This will prevent damage to the product due to lightning and power-line surges.
- 15 Power Lines – An outside antenna system should not be located in the vicinity of overhead power lines or other electric light or power circuits, or where it can fall into such power lines or circuits. When installing an outside antenna system, extreme care should be taken to keep from touching such power lines or circuits as contact with them might be fatal.
- 16 Overloading – Do not overload wall outlets, extension cords, or integral convenience receptacles as this can result in a risk of fire or electric shock.
- 17 Object and Liquid Entry – Never push objects of any kind into this product through openings as they may touch dangerous voltage points or short-out parts that could result in a fire or electric shock. Never spill liquid of any kind on the product.
- 18 Servicing – Do not attempt to service this product yourself as opening or removing covers may expose you to dangerous voltage or other hazards. Refer all servicing to qualified service personnel.
- 19 Damage Requiring Service – Unplug this product from the wall outlet and refer servicing to qualified service personnel under the following conditions:
  - a) When the power-supply cord or plug is damaged,
  - b) If liquid has been spilled, or objects have fallen into the product,
  - c) If the product has been exposed to rain or water,

- d) If the product does not operate normally by following the operating instructions. Adjust only those controls that are covered by the operating instructions as an improper adjustment of other controls may result in damage and will often require extensive work by a qualified technician to restore the product to its normal operation,
  - e) If the product has been dropped or damaged in any way, and
  - f) When the product exhibits a distinct change in performance - this indicates a need for service.
- 20 Replacement Parts** – When replacement parts are required, be sure the service technician has used replacement parts specified by the manufacturer or have the same characteristics as the original part. Unauthorized substitutions may result in fire, electric shock, or other hazards.
- 21 Safety Check** – Upon completion of any service or repairs to this product, ask the service technician to perform safety checks to determine that the product is in proper operating condition.
- 22 Wall or Ceiling Mounting** – The unit should be mounted to a wall or ceiling only as recommended by the manufacturer.
- 23 Heat** – The product should be situated away from heat sources such as radiators, heat registers, stoves, or other products (including amplifiers) that produce heat.

- 24 Outdoor Antenna Grounding** – If an outside antenna or cable system is connected to the product, be sure the antenna or cable system is grounded so as to provide some protection against voltage surges and built-up static charges. Article 810 of the National Electrical Code, ANSI/NFPA 70, provides information with regard to proper grounding of the mast and supporting structure, grounding of the lead-in wire to an antenna discharge unit, size of grounding conductors, location of antenna discharge unit, connection to grounding electrodes, and requirements for the grounding electrode.

EXAMPLE OF ANTENNA GROUNDING

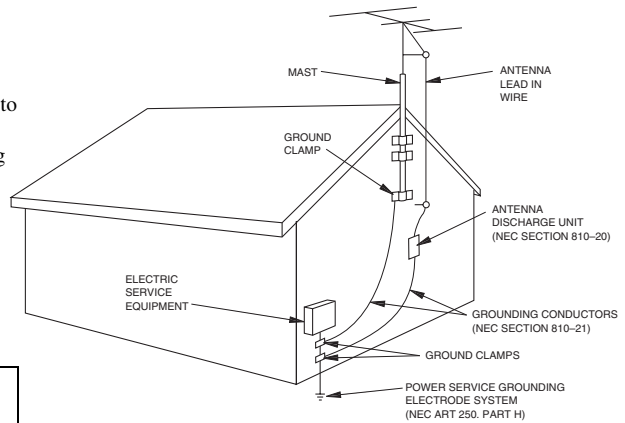

NEC – NATIONAL ELECTRICAL CODE

**Note to CATV system installer:**

This reminder is provided to call the CATV system installer’s attention to Article 820-40 of the NEC that provides guidelines for proper grounding and, in particular, specifies that the cable ground shall be connected to the grounding system of the building, as close to the point of cable entry as practical.

**FCC INFORMATION (for US customers)**

**1 IMPORTANT NOTICE: DO NOT MODIFY THIS UNIT!**

This product, when installed as indicated in the instructions contained in this manual, meets FCC requirements. Modifications not expressly approved by Yamaha may void your authority, granted by the FCC, to use the product.

- 2 IMPORTANT:** When connecting this product to accessories and/or another product use only high quality shielded cables. Cable/s supplied with this product **MUST** be used. Follow all installation instructions. Failure to follow instructions could void your FCC authorization to use this product in the USA.

- 3 NOTE:** This product has been tested and found to comply with the requirements listed in FCC Regulations, Part 15 for Class “B” digital devices. Compliance with these requirements provides a reasonable level of assurance that your use of this product in a residential environment will not result in harmful interference with other electronic devices.

This equipment generates/uses radio frequencies and, if not installed and used according to the instructions found in the users manual, may cause interference harmful to the operation of other electronic devices.

Compliance with FCC regulations does not guarantee that interference will not occur in all installations. If this product is found to be the source of interference, which can be determined by turning the unit “OFF” and “ON”, please try to eliminate the problem by using one of the following measures:

Relocate either this product or the device that is being affected by the interference.

Utilize power outlets that are on different branch (circuit breaker or fuse) circuits or install AC line filter/s.

In the case of radio or TV interference, relocate/reorient the antenna. If the antenna lead-in is 300 ohm ribbon lead, change the lead-in to coaxial type cable.

If these corrective measures do not produce satisfactory results, please contact the local retailer authorized to distribute this type of product. If you can not locate the appropriate retailer, please contact Yamaha Electronics Corp., U.S.A. 6660 Orangethorpe Ave, Buena Park, CA 90620.

# CAUTION: READ THIS BEFORE OPERATING YOUR UNIT.

- 1 To assure the finest performance, please read this manual carefully. Keep it in a safe place for future reference.
- 2 Install this sound system in a well ventilated, cool, dry, clean place – away from direct sunlight, heat sources, vibration, dust, moisture, and/or cold. Allow ventilation space of at least 30 cm on the top, 20 cm on the left and right, and 20 cm on the back of this unit.
- 3 Locate this unit away from other electrical appliances, motors, or transformers to avoid humming sounds.
- 4 Do not expose this unit to sudden temperature changes from cold to hot, and do not locate this unit in a environment with high humidity (i.e. a room with a humidifier) to prevent condensation inside this unit, which may cause an electrical shock, fire, damage to this unit, and/or personal injury.
- 5 Avoid installing this unit where foreign object may fall onto this unit and/or this unit may be exposed to liquid dripping or splashing. On the top of this unit, do not place:
  - other components, as they may cause damage and/or discoloration on the surface of this unit.
  - burning objects (i.e. candles), as they may cause fire, damage to this unit, and/or personal injury.
  - containers with liquid in them, as they may fall and liquid may cause electrical shock to the user and/or damage to this unit.
- 6 Do not cover this unit with a newspaper, tablecloth, curtain, etc. in order not to obstruct heat radiation. If the temperature inside this unit rises, it may cause fire, damage to this unit, and/or personal injury.
- 7 Do not plug in this unit to a wall outlet until all connections are complete.
- 8 Do not operate this unit upside-down. It may overheat, possibly causing damage.
- 9 Do not use force on switches, knobs and/or cords.
- 10 When disconnecting the power cable from the wall outlet, grasp the plug; do not pull the cord.
- 11 Do not clean this unit with chemical solvents; this might damage the finish. Use a clean, dry cloth.
- 12 Only voltage specified on this unit must be used. Using this unit with a higher voltage than specified is dangerous and may cause fire, damage to this unit, and/or personal injury. YAMAHA will not be held responsible for any damage resulting from use of this unit with a voltage other than specified.
- 13 To prevent damage by lightning, keep the power cord and outdoor antennas disconnected from a wall outlet or the unit during a lightning storm.
- 14 Do not attempt to modify or fix this unit. Contact qualified YAMAHA service personnel when any service is needed. The cabinet should never be opened for any reasons.
- 15 When not planning to use this unit for long periods of time (i.e. vacation), disconnect the AC power plug from the wall outlet.
- 16 Install this unit near the AC outlet and where the AC power plug can be reached easily.
- 17 Be sure to read the “TROUBLESHOOTING” section on common operating errors before concluding that this unit is faulty.
- 18 Before moving this unit, press STANDBY/ON to set this unit in the standby mode, and disconnect the AC power plug from the wall outlet.

## WARNING

TO REDUCE THE RISK OF FIRE OR ELECTRIC SHOCK, DO NOT EXPOSE THIS UNIT TO RAIN OR MOISTURE.

This unit is not disconnected from the AC power source as long as it is connected to the wall outlet, even if this unit itself is turned off by STANDBY/ON. This state is called the standby mode. In this state, this unit is designed to consume a very small quantity of power.

## FOR CANADIAN CUSTOMERS

To prevent electric shock, match wide blade of plug to wide slot and fully insert.  
This Class B digital apparatus complies with Canadian ICES-003.

## IMPORTANT

Please record the serial number of this unit in the space below.  
MODEL:  
Serial No.:  
The serial number is located on the rear of the unit.  
Retain this Owner's Manual in a safe place for future reference.

## We Want You Listening For A Lifetime

YAMAHA and the Electronic Industries Association's Consumer Electronics Group want you to get the most out of your equipment by playing it at a safe level. One that lets the sound come through loud and clear without annoying blaring or distortion – and, most importantly, without affecting your sensitive hearing.

Since hearing damage from loud sounds is often undetectable until it is too late, YAMAHA and the Electronic Industries Association's Consumer Electronics Group recommend you to avoid prolonged exposure from excessive volume levels.



# CONTENTS

## INTRODUCTION

<b>FEATURES</b> .....	<b>2</b>
<b>GETTING STARTED</b> .....	<b>3</b>
Supplied accessories .....	3
Installing batteries in the remote control .....	3
<b>CONTROLS AND FUNCTIONS</b> .....	<b>4</b>
Front panel .....	4
Remote control.....	6
Using the remote control .....	7
Front panel display .....	8
Rear panel .....	9

## PREPARATION

<b>CONNECTIONS</b> .....	<b>10</b>
Placing speakers.....	10
Connecting speakers .....	11
Information on jacks and cable plugs .....	13
Connecting video components.....	14
Connecting audio components.....	16
Connecting the FM and AM antennas .....	17
Connecting the power cable.....	18
Turning on the power.....	18
<b>SETUP</b> .....	<b>19</b>

## BASIC OPERATION

<b>PLAYBACK</b> .....	<b>20</b>
Basic operations.....	20
Enjoying surround sounds .....	22
<b>FM/AM TUNING</b> .....	<b>24</b>
Automatic tuning .....	24
Manual tuning.....	25
Automatic preset tuning.....	25
Manual preset tuning .....	27
Selecting preset stations.....	28
Exchanging preset stations .....	29
<b>RECORDING</b> .....	<b>30</b>

## ADVANCED OPERATION

<b>ADVANCED OPERATIONS</b> .....	<b>31</b>
Using the sleep timer .....	31
Dimming the front panel display .....	31
Adjusting speaker levels .....	32

## ADDITIONAL INFORMATION

<b>TROUBLESHOOTING</b> .....	<b>33</b>
<b>RESETTING THE SYSTEM</b> .....	<b>37</b>
<b>GLOSSARY</b> .....	<b>38</b>
Audio formats .....	38
Audio information .....	39
Video signal information .....	39
<b>SPECIFICATIONS</b> .....	<b>40</b>

INTRODUCTION

PREPARATION

BASIC  
OPERATION

ADVANCED  
OPERATION

ADDITIONAL  
INFORMATION

English

# FEATURES

## Built-in 6-channel power amplifier

- ◆ Minimum RMS output power per channel

[Front, center, and surround channels]

80 W (1 kHz, 0.1% THD, 6 Ω)

110 W (1 kHz, 10% THD, 6 Ω)

[Subwoofer channel]

110 W (50 Hz, 6 Ω)

## Decoders for multi-channel surround sound

- ◆ Dolby Digital decoder
- ◆ Dolby Pro Logic/Dolby Pro Logic II decoder
- ◆ DTS decoder

## Sophisticated AM/FM tuner

- ◆ 40-station random and direct preset tuning
- ◆ Automatic preset tuning
- ◆ Preset station shifting capability (preset editing)

## Other features

- ◆ A SET MENU that provides you with items for optimizing this unit for your audio/video system
- ◆ Component video input/output capability
- ◆ Optical and coaxial digital audio signal jacks
- ◆ Sleep timer

- ✨ indicates a tip for your operation.
- Some operations can be performed by using either the buttons on the front panel or on the remote control. In cases when the button names differ between the front panel and the remote control, the button name on the remote control is given in parentheses.
- This manual is printed prior to production. Design and specifications are subject to change in part as a result of improvements, etc. In case of differences between the manual and product, the product has priority.



Manufactured under license from Dolby Laboratories.  
“Dolby”, “Pro Logic”, and the double-D symbol are trademarks of Dolby Laboratories.



“DTS” and “DTS Digital Surround” are registered trademarks of Digital Theater Systems, Inc.

# GETTING STARTED

## Supplied accessories

Please check that you received all of the following parts.

Remote control

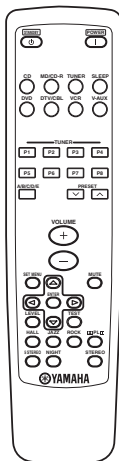

Indoor FM antenna

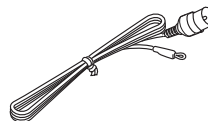

Batteries (2)  
(AAA, R03, UM-4)

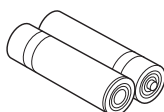

AM loop antenna



## Installing batteries in the remote control

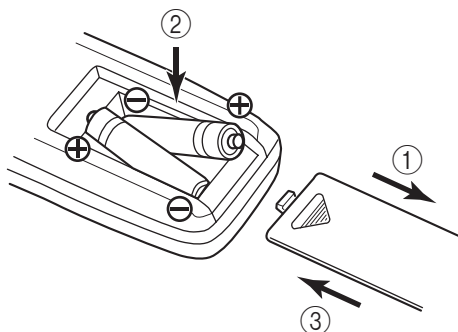

### Notes

- Change all of the batteries if you notice a decrease in the operation range of the remote control.
- Do not use an old battery together with a new one.
- Do not use different types of batteries (such as alkaline and manganese batteries) together. Read the packaging carefully as these different types of batteries may have the same shape and color.
- If the batteries have leaked, dispose of them immediately. Avoid touching the leaked material or letting it come into contact with clothing, etc. Clean the battery compartment thoroughly before installing new batteries.
- Do not throw away batteries with general house waste; dispose of them correctly in accordance with your local regulations.

**1** Take off the battery compartment cover.

**2** Insert two supplied batteries (AAA, R03, UM-4) according to the polarity markings (+ and -) on the inside of the battery compartment.

**3** Snap the battery compartment cover back into place.

# CONTROLS AND FUNCTIONS

## Front panel

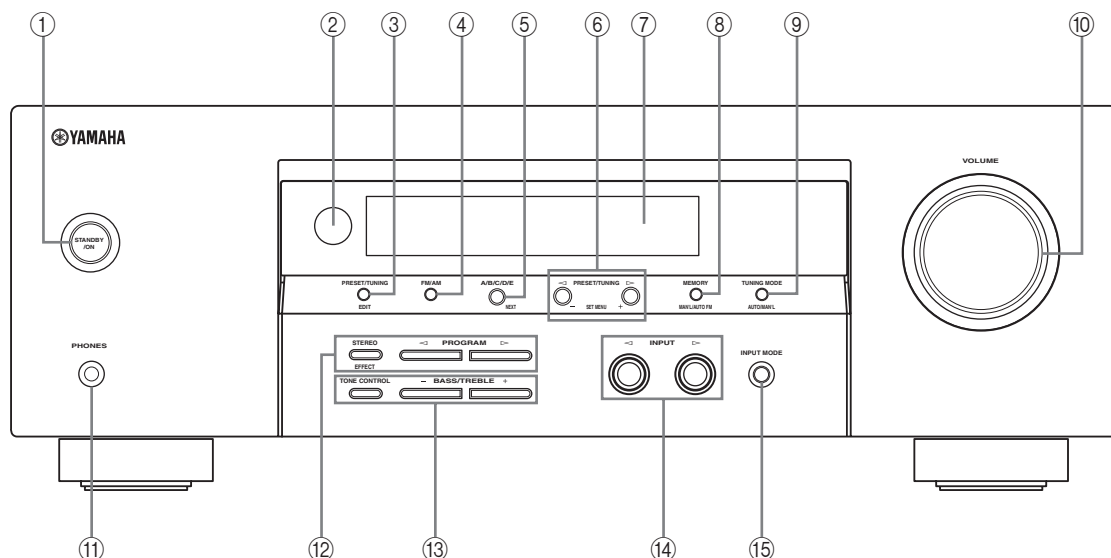

### ① STANDBY/ON

Turns on this unit or sets it to the standby mode. When you turn on this unit, you will hear a click and there will be a 4 to 5-second delay before this unit can reproduce sound.

#### Note

In the standby mode, this unit consumes a small amount of power in order to receive infrared-signals from the remote control.

### ② Remote control sensor

Receives signals from the remote control.

### ③ PRESET/TUNING

Switches the function of PRESET/TUNING  $\triangleleft / \triangleright$  between selecting preset station numbers and selecting the tuning frequency.

### ④ FM/AM

Switches the reception band between FM and AM.

### ⑤ A/B/C/D/E

Selects one of the 5 preset station groups (A to E) when this unit is in the tuner mode.

### ⑥ PRESET/TUNING $\triangleleft / \triangleright$

Selects one of the preset station numbers (1 to 8) or the tuning frequency when this unit is in the tuner mode.

### ⑦ Front panel display

Shows information about the operational status of this unit.

### ⑧ MEMORY

Stores a preset station in the memory. Hold down this button for more than 3 seconds to start automatic preset tuning.

### ⑨ TUNING MODE

Switches between automatic tuning (the AUTO indicator is turned on) and manual tuning (the AUTO indicator is turned off).

### ⑩ VOLUME

Controls the output level of all audio channels.

#### Note

This does not affect the OUT level.



**⑪ PHONES jack**

Outputs audio signals for private listening with headphones.

**Notes**

- When you connect headphones, no signals are output to the speakers.
- All Dolby Digital and DTS audio signals (except the LFE channel) are mixed down to the left and right headphone channels.

**⑫ STEREO**

Switches between normal stereo and DSP effect reproduction. When you select "STEREO", this unit mixes down all Dolby Digital and DTS signals (except the LFE channel) as well as those 2-channel signals without effect sounds to the front left and right speakers.

**PROGRAM ◀ / ▶**

Selects the surround mode.

**⑬ TONE CONTROL**

Adjusts the bass/treble balance of the front left and right speakers in conjunction with BASS/TREBLE +/-.

**BASS/TREBLE +/-**

Adjusts the bass/treble balance of the front left and right speakers in conjunction with TONE CONTROL.

**⑭ INPUT ◀ / ▶**

Selects the input source you want to listen to or watch.

**⑮ INPUT MODE**

Sets the priority (AUTO, DTS, ANALOG) for the type of signals received when one component is connected via both digital and analog connections.

## Remote control

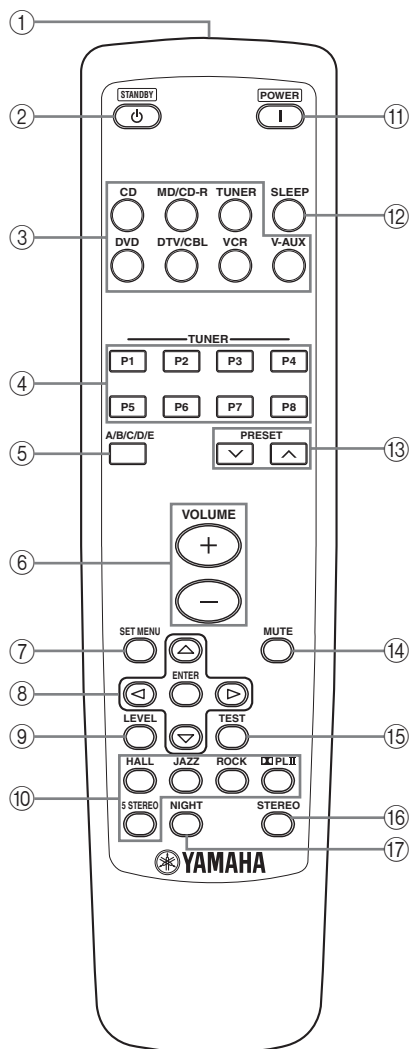

### ① Infrared signal transmitter

Outputs infrared control signals.

### ② STANDBY

Sets this unit in the standby mode.

### ③ Input selector buttons

Select the input source.

### ④ Preset station number selector buttons (P1 to P8)

Select the preset station number (1 to 8) directly when this unit is in the tuner mode.

### ⑤ A/B/C/D/E

Selects a preset station group (A to E) when this unit is in the tuner mode.

### ⑥ VOLUME +/-

Increases or decreases the volume level.

### ⑦ SET MENU

Activates the SET MENU function.

### ⑧ Cursor buttons $\triangle$ / $\nabla$ / $\triangleleft$ / $\triangleright$ , ENTER

Select and adjust the SET MENU items.

### ⑨ LEVEL

Selects the speaker channel to be adjusted and sets the output level.

### ⑩ Surround mode selector buttons

Select the surround modes.

### ⑪ POWER

Turns on this unit.

### ⑫ SLEEP

Sets the sleep timer.

### ⑬ PRESET $\wedge$ / $\vee$

Select a preset station number (1 to 8) when this unit is in the tuner mode.

### ⑭ MUTE

Mutes the audio output. Press MUTE again to restore the audio output to the previous volume level.

### ⑮ TEST

Outputs the test tone to adjust the speaker levels.

### ⑯ STEREO

Switches between normal stereo and DSP effect reproduction. When you select "STEREO", this unit mixes down all Dolby Digital and DTS signals (except the LFE channel) as well as those 2-channel signals without effect sounds to the front left and right speakers.

### ⑰ NIGHT

Turns on or off the night listening mode. The night listening mode is available only for Dolby Digital sources.

## Using the remote control

The remote control transmits a directional infrared beam. Be sure to aim the remote control directly at the remote control sensor on the front panel during operation.

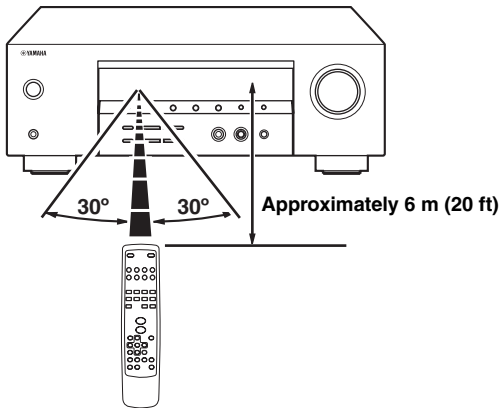

### Notes

- Do not spill water or other liquids on the remote control.
- Do not drop the remote control.
- Do not leave or store the remote control in the following types of conditions:
  - places of high humidity, such as near a bath
  - places of high temperature, such as near a heater or stove
  - places of extremely low temperatures
  - dusty places

## Front panel display

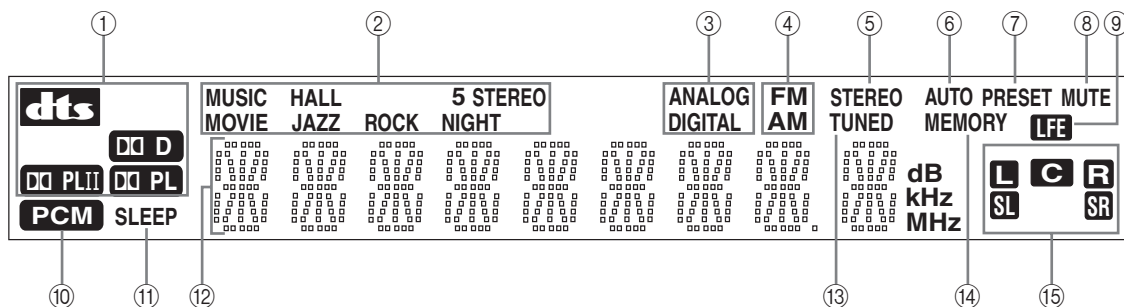

① **Decoder indicators**

The respective indicator lights up when any of the decoders of this unit function.

② **Surround mode indicators, listening mode indicators**

The respective indicator lights up when you select any of the surround mode or the listening mode.

③ **Input signal indicators**

The respective indicator lights up according to the input signal.

④ **Band indicator**

The respective indicator lights up according to the current band.

⑤ **STEREO indicator**

Lights up when this unit is receiving a strong signal for an FM stereo broadcast while the AUTO indicator is lit.

⑥ **AUTO indicator**

Lights up when this unit is in the automatic tuning mode.

⑦ **PRESET indicator**

Lights up when this unit is in the preset station selecting mode.

⑧ **MUTE indicator**

Flashes while the MUTE function is on.

⑨ **LFE indicator**

Lights up when the input signal contains the LFE signal.

⑩ **PCM indicator**

Lights up when this unit is reproducing PCM (Pulse Code Modulation) digital audio signals.

⑪ **SLEEP indicator**

Lights up while the sleep timer is on.

⑫ **Multi-information display**

Shows the current input source name and other information when adjusting or changing settings.

⑬ **TUNED indicator**

Lights up when this unit is tuned into a station.

⑭ **MEMORY indicator**

Flashes to show that a station can be stored.

⑮ **Input channel indicators**

Indicate the channel components of the current digital input signal.

## Rear panel

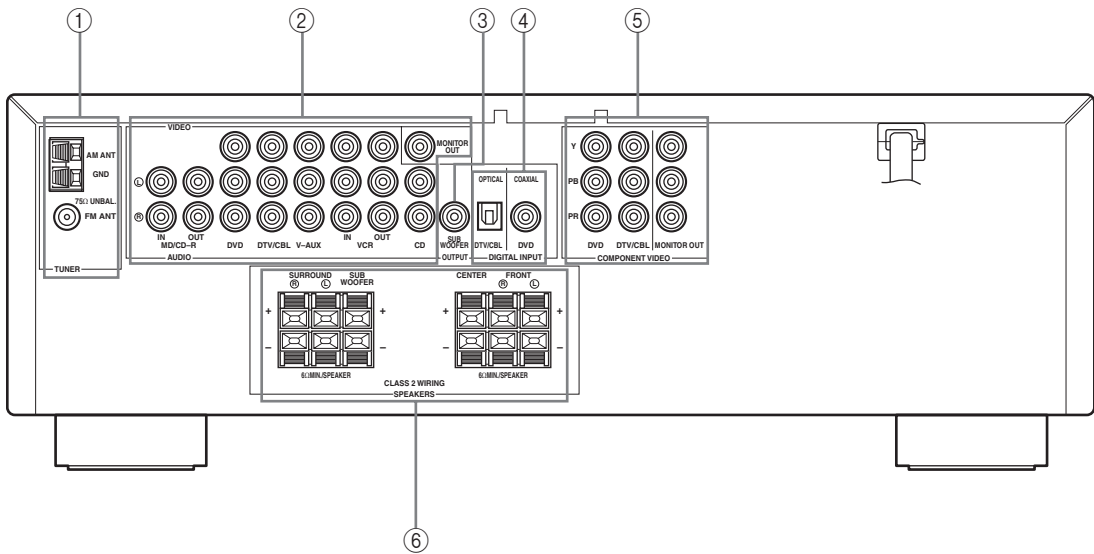

① **Antenna terminals**

See page 17 for connection information.

② **Audio and video jacks**

See page 13 for connection information.

③ **SUBWOOFER OUTPUT jack**

See page 12 for connection information.

④ **DIGITAL INPUT jacks**

See page 13 for connection information.

⑤ **COMPONENT VIDEO jacks**

See page 13 for connection information.

⑥ **Speaker terminals**

See page 11 for connection information.

# CONNECTIONS

## Placing speakers

The speaker layout below shows the standard ITU-R\* speaker setting. You can use it to enjoy surround sounds.

\* ITU-R is the radio communication sector of the ITU (International Telecommunication Union).

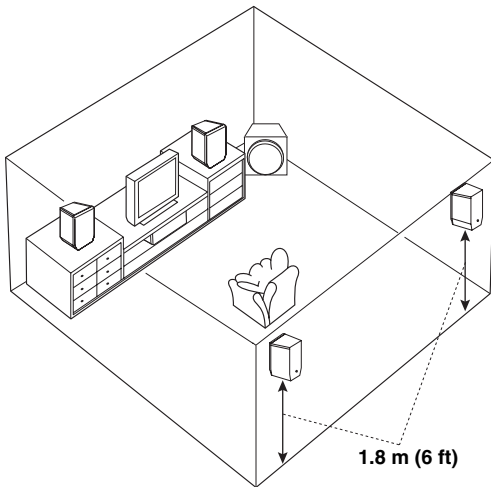
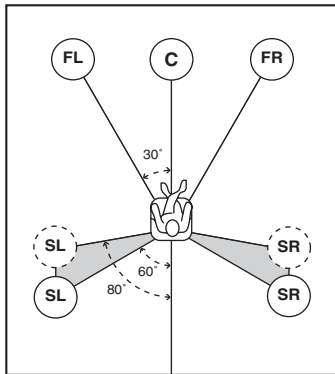

### Front speakers (FR and FL)

The front speakers are used for the main source sound plus effect sounds. Place these speakers an equal distance from the ideal listening position. The distance of each speaker from each side of the video monitor should be the same.

### Center speaker (C)

The center speaker is for the center channel sounds (dialog, vocals, etc.). If for some reason it is not practical to use a center speaker, you can do without it. Best results, however, are obtained with the full system. Align the front face of the center speaker with the front face of your video monitor. Place the speaker centrally between the front speakers and as close to the monitor as possible, such as directly over or under it.

### Surround speakers (SR and SL)

The surround speakers are used for effect and surround sounds. Place these speakers behind your listening position, facing slightly inwards, about 1.8 m (6 ft) above the floor.

### Subwoofer

The use of a subwoofer is effective not only for reinforcing bass frequencies from any or all channels, but also for high fidelity reproduction of the LFE (low-frequency effect) channel included in Dolby Digital and DTS software. The position of the subwoofer is not so critical, because low bass sounds are not highly directional. But it is better to place the subwoofer near the front speakers. Turn it slightly toward the center of the room to reduce wall reflections.

## Connecting speakers

Be sure to connect the left channel (L), right channel (R), “+” (red) and “-” (black) properly. If the connections are faulty, no sound will be heard from the speakers, and if the polarity of the speaker connections is incorrect, the sound will be unnatural and lack bass.

### CAUTION

- Use speakers with the specified impedance shown on the rear panel of this unit.
- Before connecting the speakers, make sure that this unit is turned off.
- Do not let the bare speaker wires touch each other or do not let them touch any metal part of this unit. This could damage this unit and/or speakers.
- Use magnetically shielded speakers. If this type of speakers still creates the interference with the monitor, place the speakers away from the monitor.

### ■ Connecting to the SPEAKERS terminal

A speaker cord is actually a pair of insulated cables running side by side. Cables are colored or shaped differently, perhaps with a stripe, groove or ridges. Connect the striped (grooved, etc.) cable to the “+” (red) terminals of this unit and your speaker. Connect the plain cable to the “-” (black) terminals.

- 1 Remove approximately 10 mm (3/8”) of insulation from the end of each speaker cable and then twist the exposed wires of the cable together to prevent short circuits.

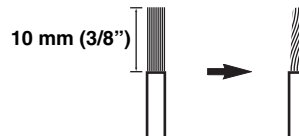

- 2 Press and open the tab.

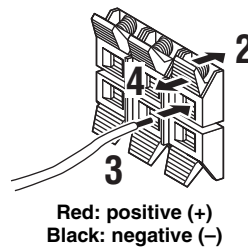

- 3 Insert one bare wire into the hole of each terminal.
- 4 Release the tab to secure the wire.

### ■ Connecting to the SUBWOOFER OUTPUT jack

If you do not use the YAMAHA SW-P170 subwoofer, connect a subwoofer with a built-in amplifier.

Connect the input jack of your subwoofer to the SUBWOOFER OUTPUT jack using the subwoofer cable.

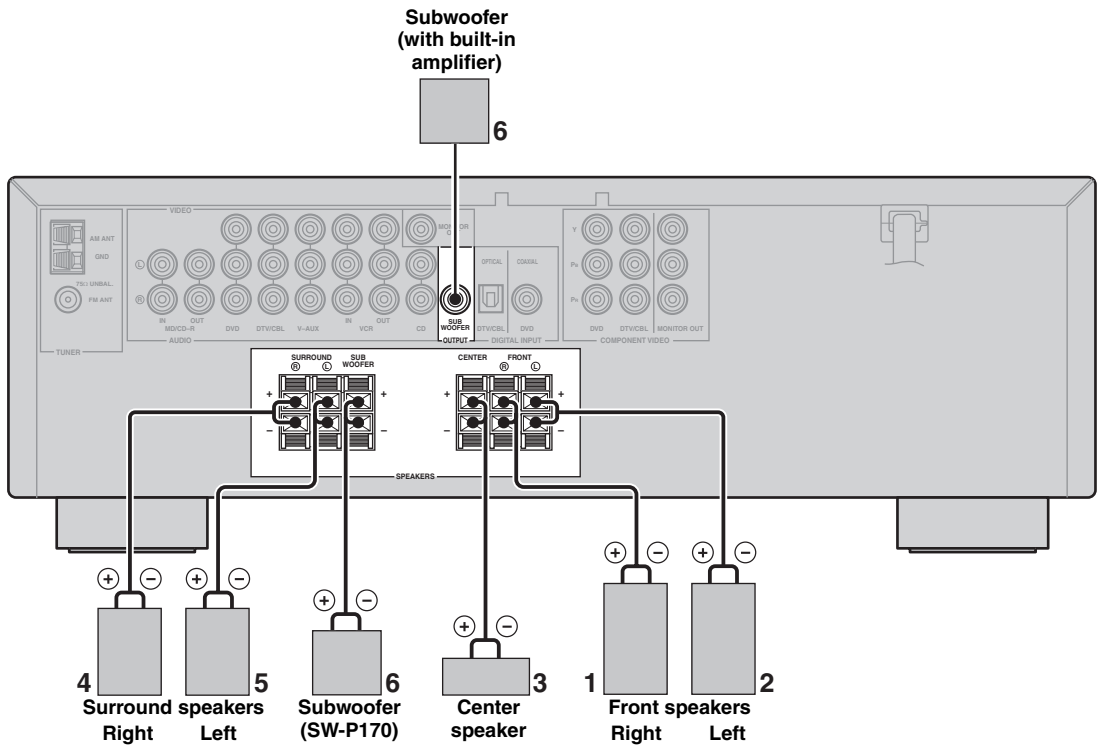

■ **FRONT terminals**

Connect one or two speaker systems (1, 2) to these terminals.

■ **CENTER terminals**

Connect a center speaker (3) to these terminals.

■ **SURROUND terminals**

Connect surround speakers (4, 5) to these terminals.

■ **SUBWOOFER terminals**

Connect the YAMAHA SW-P170 subwoofer (6) to these terminals.

■ **SUBWOOFER OUTPUT jack**

Connect a subwoofer with a built-in amplifier (6) to this jack when you do not use the YAMAHA SW-P170 subwoofer.

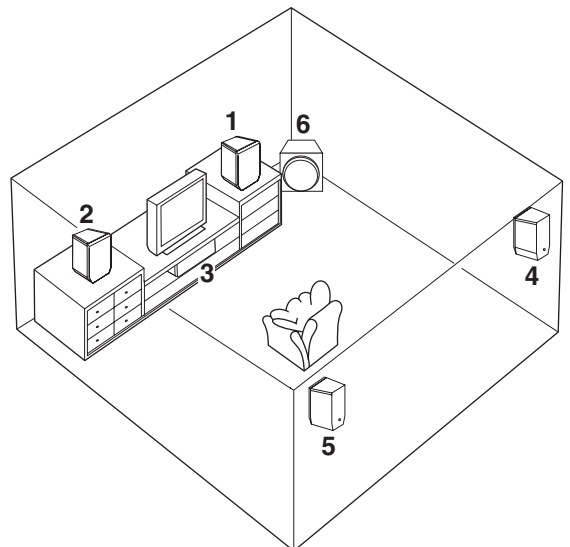

Speaker layout



## Information on jacks and cable plugs

### Audio jacks and cable plugs

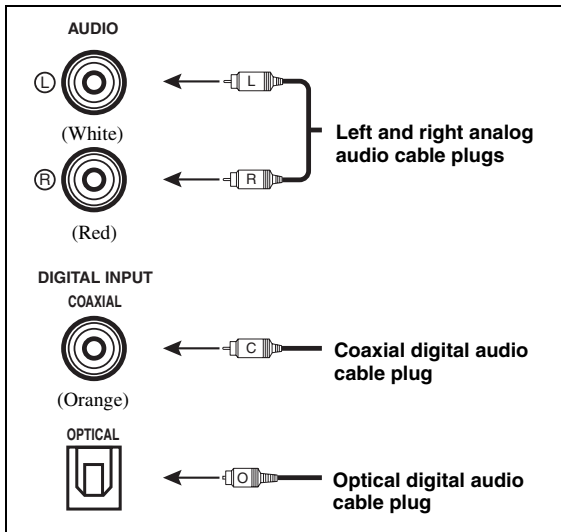

### Video jacks and cable plugs

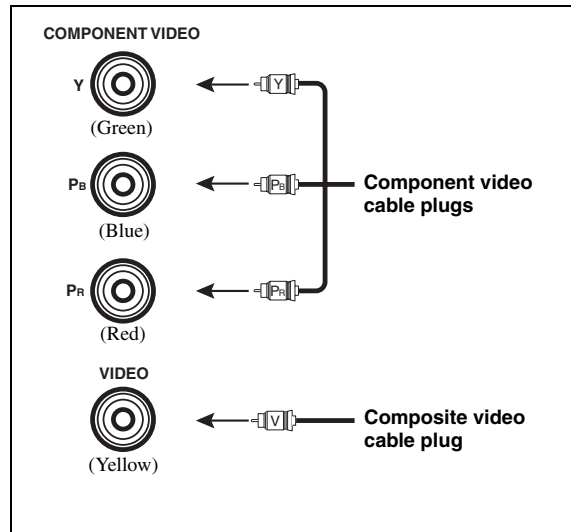

#### ■ Audio jacks

This unit has three types of audio jacks (analog audio, digital audio coaxial, and digital audio optical). Connection depends on the availability of audio jacks on your other components.

#### AUDIO jacks

For conventional analog audio signals transmitted via left and right analog audio cables. Connect red plugs to the right jacks and white plugs to the left jacks.

#### DIGITAL AUDIO COAXIAL jack

For digital audio signals transmitted via a coaxial digital audio cable.

#### DIGITAL AUDIO OPTICAL jack

For digital audio signals transmitted via an optical digital audio cable.

#### Notes

- You can use the digital jacks to input PCM, Dolby Digital and DTS bitstreams. All digital input jacks are compatible with 96 kHz sampling digital signals.
- This unit handles digital and analog signals independently. Thus audio signals input at the analog jacks are output only at the analog AUDIO OUT jacks.

#### ■ Video jacks

This unit has two types of video jacks (composite video, and component video). Connection depends on the availability of input jacks on your video monitor.

#### VIDEO jacks

For conventional composite video signals transmitted via composite video cables.

#### COMPONENT VIDEO jacks

For component signals, separated into the luminance (Y) and chrominance (P<sub>B</sub>, P<sub>R</sub>) video signals transmitted on separate wires of component video cables.

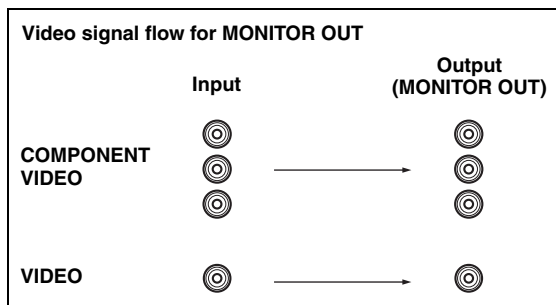

## Connecting video components

### ■ Connecting a video monitor

Connect the video input jack of your video monitor to the MONITOR OUT jack.

### ■ Connecting a DVD player/digital TV/cable TV

Connect the optical digital audio signal output jack of your DVD player to the DIGITAL INPUT DVD jack and connect the video signal output jack of the component to the DVD VIDEO jack of this unit.

Connect the coaxial digital audio signal output jack of your digital TV or cable TV to the DIGITAL INPUT DTV/CBL jack and connect the video signal output jack of the component to the DTV/CBL VIDEO jack of this unit.



- Use the AUDIO jacks of this unit for a video component which does not have optical digital output jack. If you wish to enjoy the surround sound, select a surround mode (page 22).
- You can also connect a video monitor, DVD player, digital TV, and cable TV to this unit using the COMPONENT VIDEO connections (page 15).

### ■ Connecting another video component

Connect the video signal output jack of your component to the V-AUX VIDEO jack on this unit.

Connect the audio signal output jacks of the component to the V-AUX AUDIO jacks on this unit.

### ■ Connecting a recording component

Connect the audio signal input jacks on your video component to the VCR OUT AUDIO jacks of this unit. Then connect the video signal input jack of the video component to the VCR OUT VIDEO jack of this unit for picture recording. Connect the audio signal output jacks on your component to the VCR IN AUDIO jacks of this unit. Then connect the video signal output jack of the component to the VCR IN VIDEO jack on this unit to play a source from your recording component.

### Notes

- Once you have connected a recording component to this unit, keep the component turned on while using this unit. If the component is turned off, this unit may distort the sound from other components.
- Be sure to connect your video source components in the same way you connect your video monitor to this unit. For example, if you connect your video monitor to this unit using a VIDEO connection, connect your video source components to this unit using the VIDEO connections.

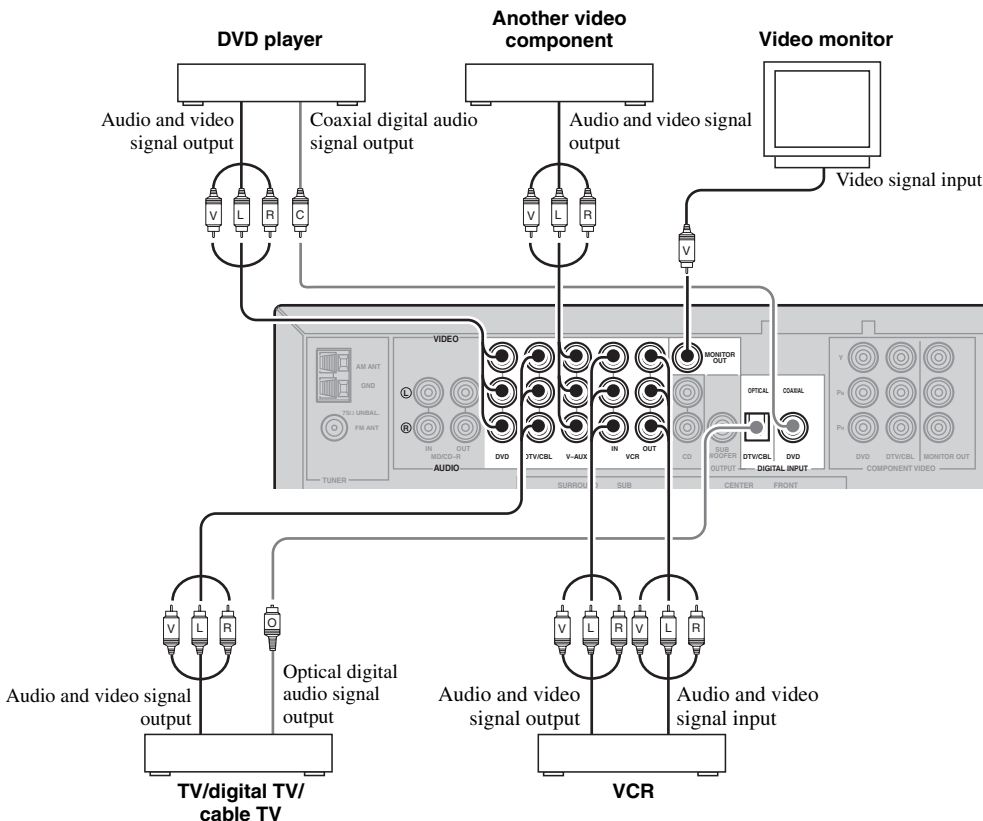

### ■ Connecting to the COMPONENT VIDEO jacks

You can enjoy high-quality pictures by connecting your video monitor and video source components to this unit using COMPONENT VIDEO connections.

**Note**

Be sure to connect your video source components in the same way you connect your video monitor to this unit. For example, if you connect your video monitor to this unit using a COMPONENT VIDEO connection, connect your video source components to this unit using the COMPONENT VIDEO connection.

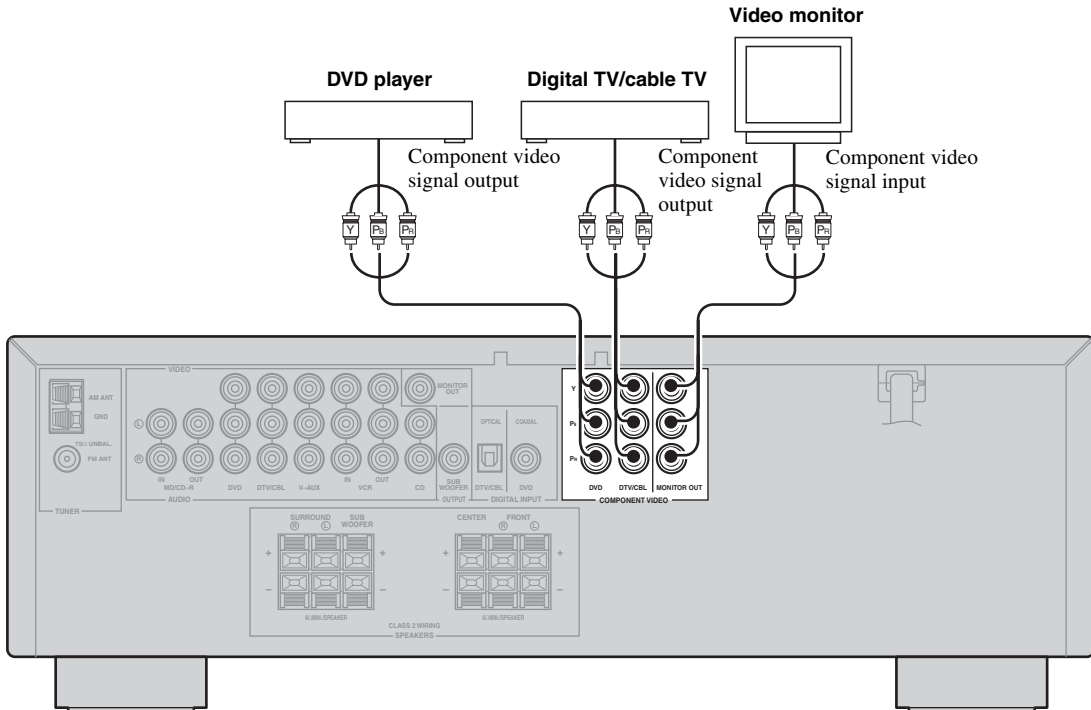

PREPARATION

English

## Connecting audio components

### Note

Once you have connected a recording component to this unit, keep the component turned on while using this unit. If the component is turned off, this unit may distort the sound from other components.

#### ■ Connecting a CD player

Connect the output jacks of your CD player to the CD jacks of this unit.

#### ■ Connecting a CD recorder or MD recorder

Connect the input jacks of your CD recorder or MD recorder to the MD/CD-R OUT jacks.

Connect the output jacks of your CD recorder or MD recorder to the MD/CD-R IN jacks to play a source from your recording component.

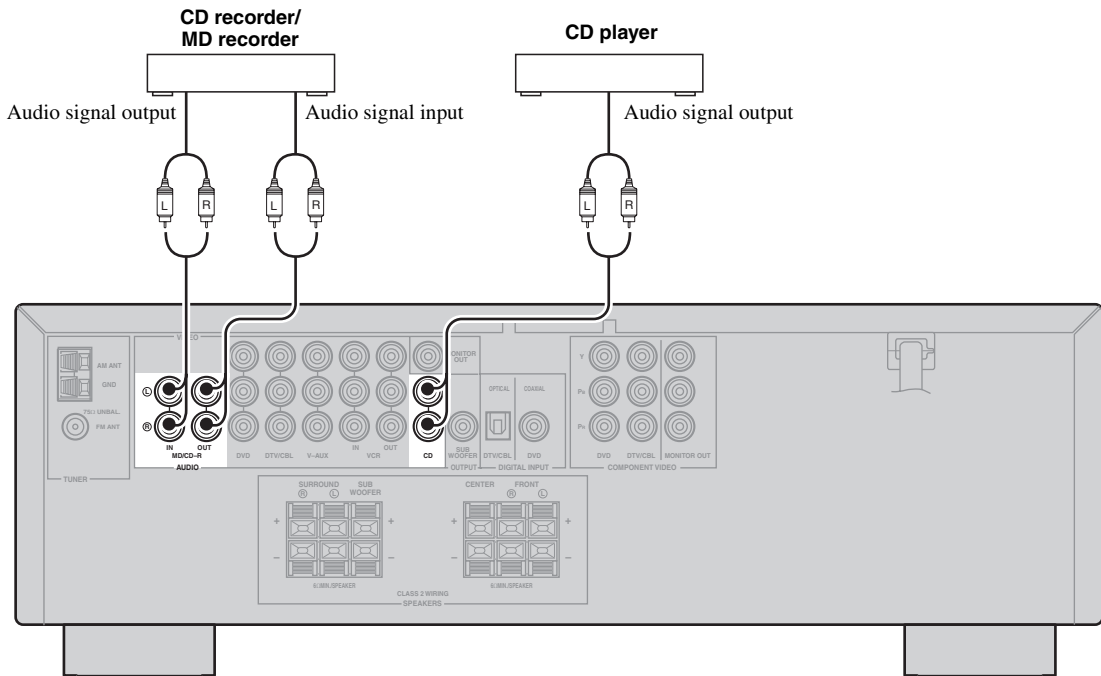

## Connecting the FM and AM antennas

Both FM and AM indoor antennas are supplied with this unit. In general, these antennas should provide sufficient signal strength. Connect each antenna correctly to the designated terminals.

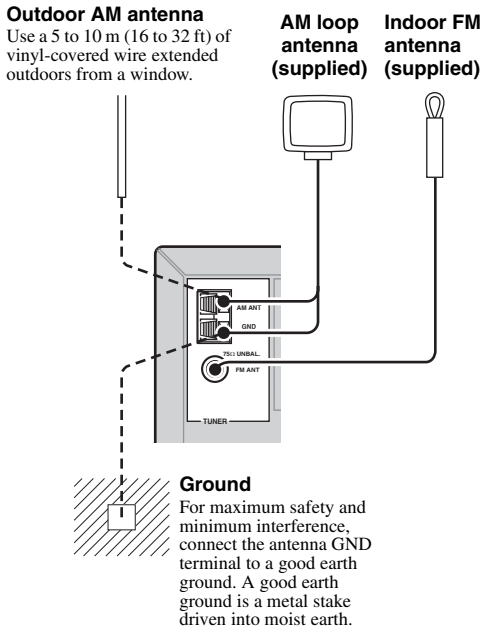

### ■ Connecting the AM loop antenna

#### 1 Set up the AM loop antenna.

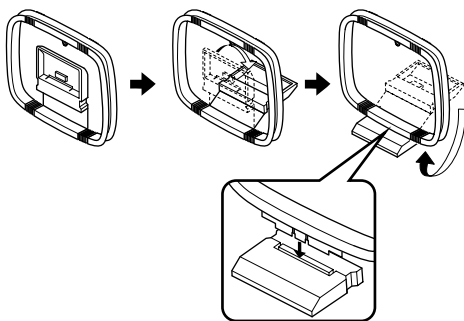

#### 2 Press and hold the tab of the AM ANT terminal.



#### 3 Insert one of the AM loop antenna lead wires into the AM ANT terminal.

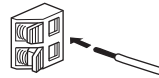

#### 4 Release the tab of the AM ANT terminal back into place.



#### 5 Repeat steps 2 through 4 to connect the other lead wire to the GND terminal.

Once you have properly connected the AM loop antenna to this unit, orient the AM loop antenna for the best reception when you tune into AM stations.

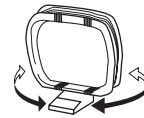

#### Notes

- The AM loop antenna should be placed away from this unit.
- A properly installed outdoor antenna provides clearer reception than an indoor one. If you experience poor reception quality, an outdoor antenna may improve the quality. Consult the nearest authorized YAMAHA dealer or service center about outdoor antennas.
- The AM loop antenna should always be connected, even if an outdoor AM antenna is connected to this unit.

## Connecting the power cable

Once all connections are complete, plug the power cable into the AC wall outlet.

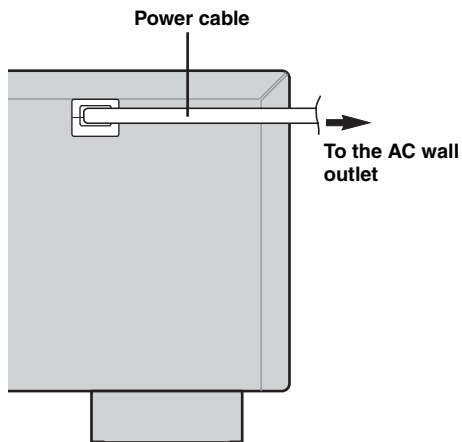

### ■ Memory back-up

The memory back-up circuit prevents the stored data from being lost even if this unit is in the standby mode. However, the stored data will be lost in case the power cable is disconnected from the AC wall outlet or if the power supply is cut off for more than one week.

## Turning on the power

When all connections are complete, turn on this unit.

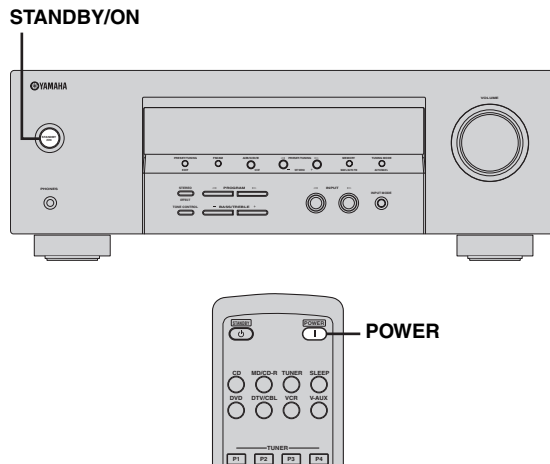

**Press STANDBY/ON on the front panel (or POWER on the remote control) to turn on this unit.**



Front panel

or



Remote control

Press STANDBY/ON on the front panel (or STANDBY on the remote control) to set this unit to the standby mode.

# SETUP

The SET MENU function enables you to set up your system quickly.

## Notes

- Initial settings are indicated in bold for each parameter.
- Make sure you disconnect your headphones from this unit.



You can use NEXT (A/B/C/D/E) and SET MENU +/- (PRESET/TUNING </>) on the front panel to change these settings, if "TUNER" is not selected as the input source. Press NEXT to select the category or field you wish to change, and SET MENU +/- to change the parameters.

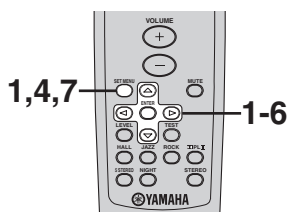

- 1 Press SET MENU repeatedly so that "SPK SET" appears in the front panel display, and then press ENTER.

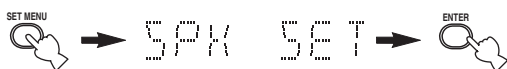

- 2 Press  $\Delta$  /  $\nabla$  to select "FRNT" (front speakers), "CNTR" (center speaker), "SURR" (surround speakers), or "SWFR" (subwoofer), and then press  $\triangleleft$  /  $\triangleright$  to select the settings according to your system.

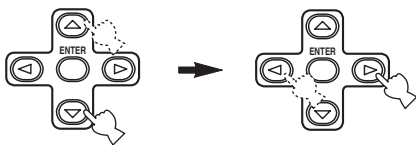

**FRNT** (front speakers)  
**CNTR** (center speaker)  
**SURR** (surround speakers)

LRG (large) If you have large front/center/surround speakers in your system.

SML (small) If you have small front/center/surround speakers in your system.

NONE If you do not have center/surround speakers in your system.

**SWFR** (subwoofer)

YES If you have a subwoofer in your system.

NONE If you do not have a subwoofer in your system.

## Notes

- If you change the current setting for "SWFR" to "NONE" when "FRNT" is set to "SML", "FRNT" is automatically set to "LRG".
- You cannot set "FRNT" to "SML" when "SWFR" is set to "NONE".

- 3 Press  $\Delta$  /  $\nabla$  repeatedly to exit the "SPK SET" menu.



- 4 Press SET MENU repeatedly so that "SPK DIST" appears in the front panel display, and then press ENTER.



- 5 Press  $\Delta$  /  $\nabla$  to select "FRNT" (front speakers), "CNTR" (center speaker) or "SURR" (surround speakers) and then press  $\triangleleft$  /  $\triangleright$  to select the speaker distance of each speaker from the listening position.

You can set the distance from 1 foot to 30 feet.

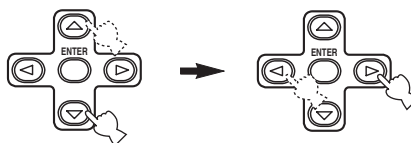

- 6 Press  $\Delta$  /  $\nabla$  repeatedly to exit the "SPK DIST" menu.



- 7 Press SET MENU repeatedly to exit the SET MENU function.



See page 32 for details about the speaker level adjustment.

# PLAYBACK

## Basic operations

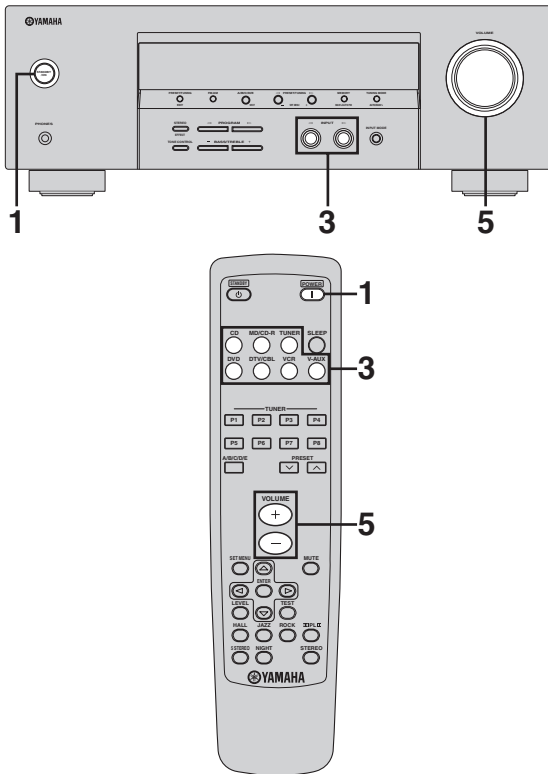

- 1 Press **STANDBY/ON** on the front panel (or **POWER** on the remote control) to turn on this unit.

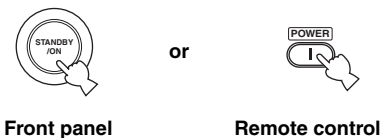

- 2 Turn on the video monitor connected to this unit.

- 3 **Select the input source.**

Press **INPUT**  $\triangleleft/\triangleright$  on the front panel repeatedly (or press one of the input selector buttons on the remote control) to select the input you desire.

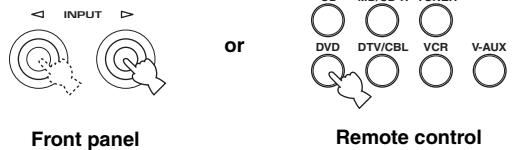

The current input source name appears in the front panel display.

DVD

- 4 **Start playback or select a broadcast station on the source component.**

Refer to the operating instructions for the component. See page 24 for details about tuning instructions.

- 5 **Rotate VOLUME on the front panel (or press VOLUME +/- on the remote control) to adjust the volume to the desired output level.**

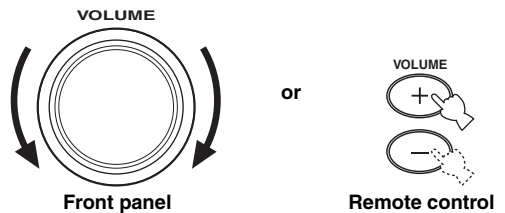

### Note

If you have connected a recording component to the VCR OUT, or MD/CD-R OUT jacks, and you notice distortion or low volume during playback from other components, try turning on the recording component.



## ■ Selecting input modes

This unit comes with 2 types of input jacks. Do the following to select the type of input signals you want to use.

- 1 Press **INPUT** ◀/▶ on the front panel repeatedly (or one of the input selector buttons on the remote control) to select “DVD” or “DTV/CBL” as the input source.

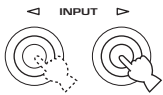

Front panel

or

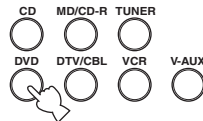

Remote control

- 2 Press **INPUT MODE** on the front panel repeatedly to select the desired input mode.



AUTO

### AUTO

Automatically selects input signals in the following order:

- 1) Digital signals
- 2) Analog signals

### DTS

Selects only digital signals encoded in DTS. If no DTS signals are input, no sound is output.

### ANALOG

Selects only analog signals. If no analog signals are input, no sound is output.



We recommend setting the input mode to “AUTO” in most cases.

### Notes

- When playing a DTS-CD/LD, be sure to set the input mode to DTS.
- Depending on the player, DTS decoding may not be performed correctly.

## ■ Listening with headphones

Connect headphones to the PHONES jack.

### Note

Multi-channel signals (except the LFE channel) are down-mixed to stereo and output from the headphones.

## ■ Adjusting the frequency response levels

You can adjust the frequency response levels of your front left and right speakers.

Press **TONE CONTROL** on the front panel repeatedly to select “BASS” or “TREBLE”, then press **BASS/TREBLE +/-** on the front panel repeatedly to adjust the corresponding frequency response level.



- Select “BASS” to adjust the low frequency response level.
- Select “TREBLE” to adjust the high frequency response level.

### Note

If you increase or decrease the high-frequency or low-frequency sound to an extreme level, the tonal quality of the surround speakers may not match that of the front left and right speakers.

## ■ Muting the sound

Press **MUTE** on the remote control. The **MUTE** indicator flashes in the front panel display.



Press **MUTE** again or press **VOLUME +/-** on the remote control to resume the audio output. The **MUTE** indicator disappears from the front panel display.

## ■ Playing video sources in the background

You can combine a video image from a video source with sound from an audio source. For example, you can enjoy listening to classical music while viewing beautiful scenery from the video source on the video monitor. Use the input selector buttons on the remote control to select a video source and then select an audio source.

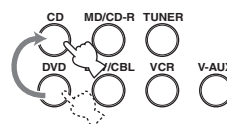

## Enjoying surround sounds

When a multi-channel signal (Dolby Digital or DTS) is input digitally, this unit decodes the signal and reproduces surround sound. Follow the procedures below to enjoy surround sound from 2-channel sources.

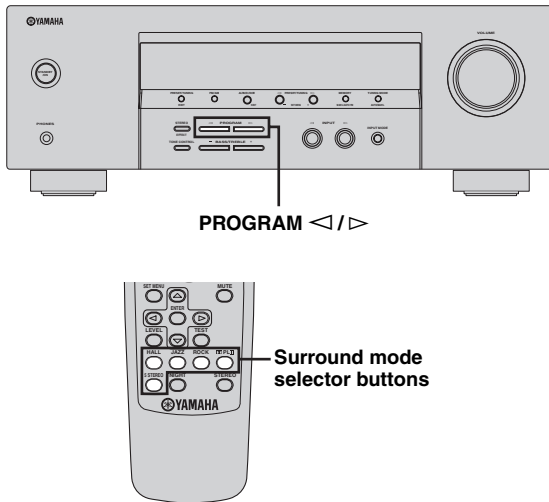

While playing back a 2-channel source, press **PROGRAM**  $\triangleleft/\triangleright$  on the front panel repeatedly (or press one of the surround mode selector buttons on the remote control) to select the desired surround mode.

To select "PRO LOGIC", "PLII MOVIE" or "PLII MUSIC" with the remote control, press  $\square$  PLII repeatedly.

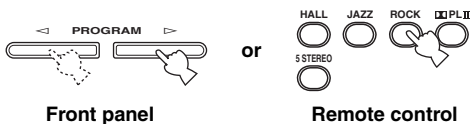

Front panel

Remote control

Lights up

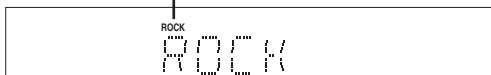

The corresponding surround mode indicator lights up in the front panel display and the name of the currently selected surround mode appears in the front panel display for a few seconds.



When you select an input source, this unit automatically selects the last surround mode used with that source.

## Surround modes

### HALL

This mode is suited especially for classical music.

### JAZZ

This mode offers a real and vibrant sound.

### ROCK

This mode is ideal for lively, dynamic rock music.

### 5 STEREO

This mode increases the listening position range. This mode is suited for background music at parties, etc.

### PLII MOVIE/PLII MUSIC

Dolby Pro Logic II decodes sound signals into 5 discrete full-range channels (3 channels in front and 2 channels in surround). There are 2 modes: PLII MOVIE for movie and PLII MUSIC for 2-channel audio sources.

You can change the surround parameters of PLII MUSIC (see "Adjusting the surround parameters of PLII MUSIC" on page 23).

### PRO LOGIC

Dolby Pro Logic decodes a stereo signal into 4 channels (front left, front right, center and monaural surround channels).



- Feel free to choose a surround mode based on your listening preference, and not purely on the name of the program itself.
- You can select "PLII MOVIE", "PLII MUSIC", or "PRO LOGIC" when a Dolby Digital signal is input digitally.

### Note

When sampling frequencies higher than 48 kHz are input, this unit is automatically set to the "STEREO" mode (see page 23).

## Adjusting the surround parameters of PLII MUSIC

- 1 While playing a source with PLII MUSIC, press  $\triangle$  /  $\nabla$  on the remote control to select “PANO” (PANORAMA), “DIMEN” (DIMENSION) or “CT WID” (CT WIDTH).
- 2 Press  $\triangleleft$  /  $\triangleright$  on the remote control to adjust the parameters.

### PANO (PANORAMA)

Sends stereo signals to the surround speakers as well as the front speakers for a wraparound effect.

Choices: OFF, ON

Initial setting: OFF

### DIMEN (DIMENSION)

Adjusts the surround sound either towards the front or towards the rear.

Control range: -3 (towards the rear) to +3 (towards the front)

Initial setting: STD (standard)

### CT WID (CT WIDTH)

Adjusts the center image from all three front speakers to varying degrees. A larger value adjusts the center image towards the front left and right speakers.

Control range: 0 (center channel sound is output only from the center speaker) to 7 (center channel sound is output only from the front left and right speakers)

Initial setting: 3

## Enjoying high fidelity stereo sound

Press **STEREO** on the front panel (or press **STEREO** on the remote control) to select “STEREO”.

The sound effects are turned off and no sound is output from the center speaker or surround speakers.

Press **STEREO** on the front panel (or **STEREO** on the remote control) again to turn off the sound effects.



Front panel

or



Remote control

### Notes

- If you turn off the sound effects while this unit is reproducing sound from a Dolby Digital or DTS signal, the dynamic range of the signal is automatically compressed and this unit mixes the sounds of the center and surround speaker channels and outputs them from the front speakers.
- The volume may be greatly reduced when you turn off the sound effects. In this case, turn on the sound effects.

## Night listening mode

The night listening mode is designed to improve listenability at lower volumes or at night.

Press **NIGHT** on the remote control repeatedly to select “NIGHT ON”.

The **NIGHT** indicator in the front panel display lights up. Select “NIGHT OFF” to turn off the night listening mode.



### Notes

- You can use the night listening mode only with the Dolby Digital sources.
- If you select the “STEREO” mode or if you connect the headphones while multi-channel Dolby Digital source is reproduced, the night listening mode is not available.
- The night listening mode may vary in effectiveness depending on the input source and surround sound settings you use.

# FM/AM TUNING

## Automatic tuning

There are 2 tuning methods: automatic and manual. Automatic tuning is effective when station signals are strong and there is no interference.

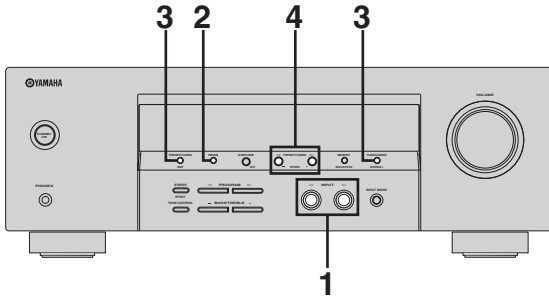

- 1 Press INPUT  $\triangleleft/\triangleright$  on the front panel to select "FM" or "AM".

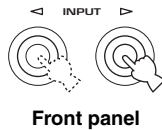

- 2 Press FM/AM on the front panel to select the reception band.



- 3 Press TUNING MODE on the front panel so that the AUTO indicator lights up in the front panel display.



If the PRESET indicator appears in the front panel display, tuning is not possible. Press PRESET/TUNING on the front panel so that the PRESET indicator disappears.



- 4 Press PRESET/TUNING  $\triangleleft/\triangleright$  on the front panel once to begin automatic tuning.

Press  $\triangleright$  to tune into a higher frequency, or press  $\triangleleft$  to tune into a lower frequency.

When this unit is tuned into a station, the TUNED indicator lights up and the frequency of the received station is shown in the front panel display.

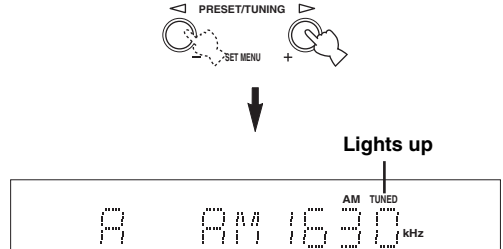

## Manual tuning

If the signal received from the station you want to select is weak, tune into it manually.

### Note

Manually tuning into an FM station will automatically switch the tuner to monaural reception to increase the signal quality.

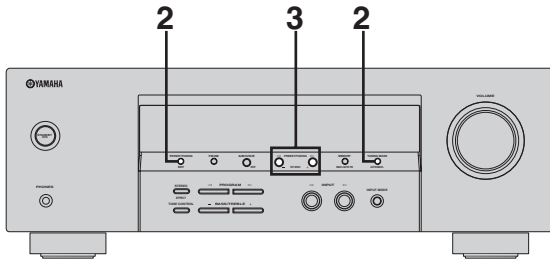

**1** Select **TUNER** and the reception band following steps 1 and 2 as described in “Automatic tuning”.

**2** Press **TUNING MODE** so that the **AUTO** indicator disappears from the front panel display.



If the **PRESET** indicator appears in the front panel display, tuning is not possible. Press **PRESET/TUNING** on the front panel display so that the **PRESET** indicator disappears from the front panel display.



**3** Press **PRESET/TUNING**  $\triangleleft$  /  $\triangleright$  on the front panel display to tune into the desired station manually.

Hold down the button to continue searching.



## Automatic preset tuning

You can use the automatic preset tuning feature to store FM stations with strong signals up to 40 (A1 to E8: 8 preset station numbers in each of the 5 preset station groups) of those stations in order. You can then recall any preset station easily by selecting the preset station number.

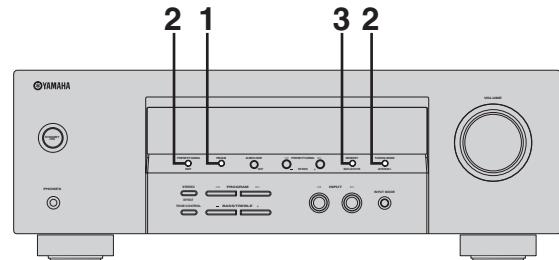

**1** Press **FM/AM** to select “**FM**” as the reception band.



Front panel

**2** Press **TUNING MODE** on the front panel so that the **AUTO** indicator lights up in the front panel display.



### 3 Press and hold MEMORY on the front panel for more than 3 seconds.

The preset station number and the MEMORY and AUTO indicators flash. After approximately 5 seconds, automatic presetting starts from the current frequency and proceeds toward the higher frequencies.

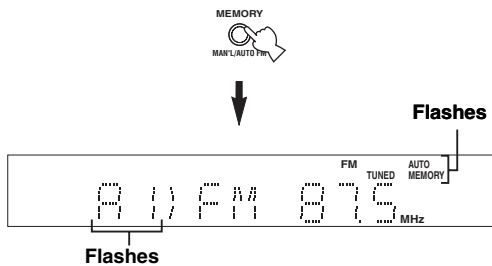

When automatic preset tuning is completed, the front panel display shows the frequency of the last preset station.

#### Notes

- Any stored station data existing under a preset station number is cleared when you store a new station under the same preset number.
- If the number of received stations does not reach 40 (E8), automatic preset tuning automatically stops after searching for all the available stations.
- Only FM stations with sufficient signal strength are stored automatically by automatic preset tuning. If the station you want to store is weak in signal strength, tune into it manually and store it as described in “Manual preset tuning” on page 27.

#### ■ Customized automatic preset tuning

You can select the preset number from which this unit will store FM stations and/or begin tuning toward lower frequencies.

After pressing MEMORY in step 3:

- 1 Press A/B/C/D/E, and then PRESET/TUNING ◀/▶ to select the preset number under which the first station will be stored. Automatic preset tuning stops when stations have all been stored up to E8.
- 2 Press PRESET/TUNING so that the PRESET indicator disappears from the front panel display and then press PRESET/TUNING ◀ to begin tuning toward the lower frequencies.

## Manual preset tuning

You can also store up to 40 stations (8 stations x 5 groups) manually.

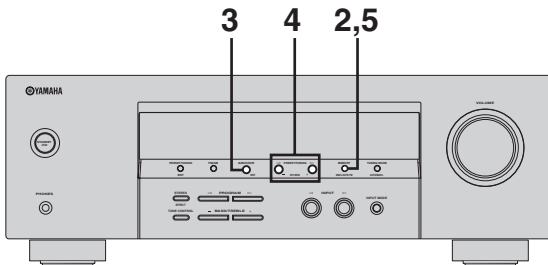

### 1 Tune into a station.

See page 24 for tuning instructions.

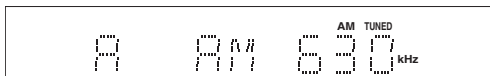

When tuned into a station, the front panel display shows the frequency of the station received.

### 2 Press MEMORY on the front panel.

The MEMORY indicator flashes for approximately 5 seconds.



### 3 Press A/B/C/D/E on the front panel repeatedly to select a preset station group (A to E) while the MEMORY indicator is flashing.

### 4 Press PRESET/TUNING </> on the front panel to select a preset station number (1 to 8) while the MEMORY indicator is flashing.

Press > to select a higher preset station number.

Press < to select a lower preset station number.

### 5 Press MEMORY on the front panel while the MEMORY indicator is flashing.

The station band and frequency appear in the front panel display with the preset group and number you have selected.

### 6 Repeat steps 1 through 5 to store other stations.

- Any stored station data existing under a preset station number is cleared when you store a new station under the same preset station number.
- The reception mode (stereo or monaural) is stored along with the station frequency.

## Selecting preset stations

You can tune into any desired station simply by selecting the preset station group and number under which it was stored.

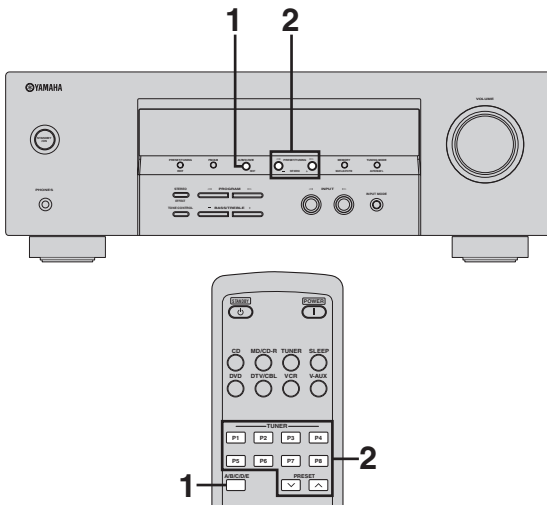

- 2 Press PRESET/TUNING ◀/▶ on the front panel (or one of the preset station number selector buttons or PRESET ^/▼ on the remote control) to select the desired preset station number (1 to 8).

The preset station group and number appear in the front panel display along with the station band and frequency.



- 1 Press A/B/C/D/E on the front panel (or A/B/C/D/E on the remote control) to select the desired preset station group (A to E).

The preset station group letter appears in the front panel display and changes each time you press the button.



or





## Exchanging preset stations

You can exchange the assignment of two preset stations with each other. The example below describes the procedure for exchanging preset station “E1” with “A5”.

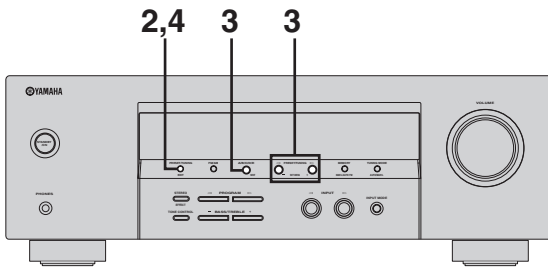

### 1 Select preset station “E1”.

See “Selecting preset stations” on page 28.

### 2 Press and hold PRESET/TUNING on the front panel for more than 3 seconds.

“E1” and the MEMORY indicator flash in the front panel display.

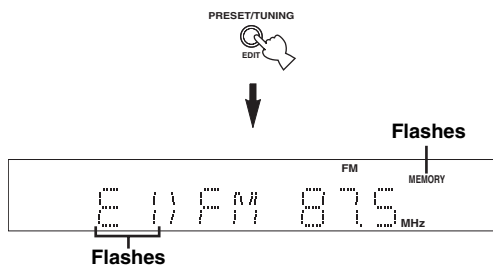

### 3 Select preset station “A5” using A/B/C/D/E and PRESET/TUNING </> on the front panel.

“A5” and the MEMORY indicator flash in the front panel display.

See “Selecting preset stations” on page 28.

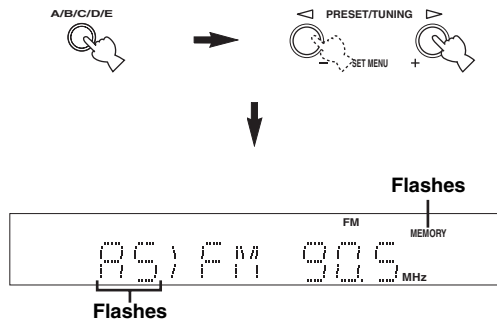

### 4 Press PRESET/TUNING again.

“EDIT E1-A5” appears in the front panel display and the assignments of the two preset stations are exchanged.

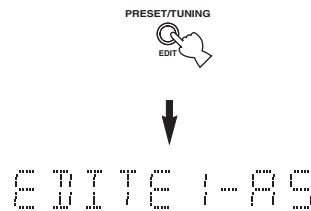

# RECORDING

Recording adjustments and other operations are performed from the recording components. Refer to the operating instructions for those components.

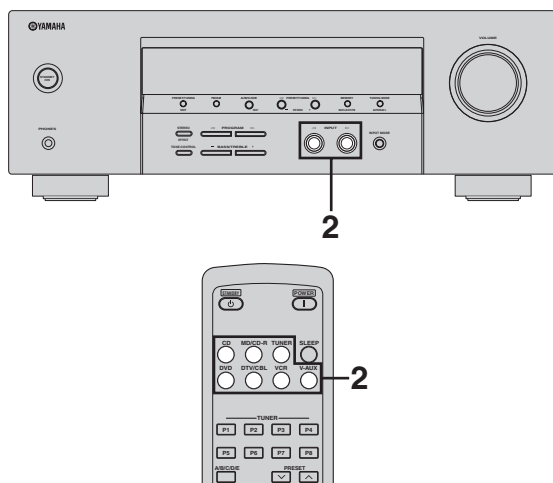

## Notes

- When this unit is set to the standby mode, you cannot record between other components connected to this unit.
- The setting of frequency response levels (page 21), volume, speaker levels (page 32) and the surround mode do not affect recorded material.
- A given input source is not output on the same OUT channel. (For example, the signal input at VCR IN is not output at VCR OUT.)
- Check the copyright laws in your country to record from CDs, radio, etc. Recording of copyrighted material may infringe copyright laws.

If you play back a video source that uses scrambled or encoded signals to prevent it from being dubbed, the picture itself may be disturbed due to those signals.

**1 Turn on all the connected components.**

**2 Press INPUT ◀/▶ on the front panel (or one of the input selector buttons on the remote control) to select the source component you want to record from.**

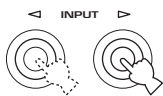

Front panel

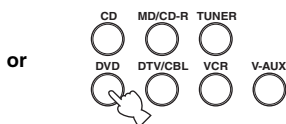

Remote control

**3 Start playback on the selected source component or select a broadcast station.**

**4 Start recording on the recording component.**



Do a test recording before you start an actual recording.

# ADVANCED OPERATIONS

## Using the sleep timer

Use this feature to automatically set this unit to the standby mode after a certain amount of time. The sleep timer is useful when you are going to sleep while this unit is playing or recording a source.

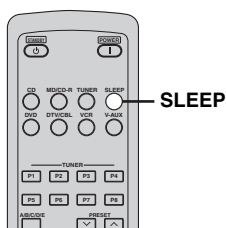

Press **SLEEP** on the remote control repeatedly to set the amount of time.



Each time you press **SLEEP**, the front panel display changes as shown below.

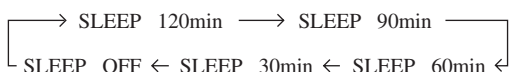

The **SLEEP** indicator flashes while you are switching the amount of time for the sleep timer.

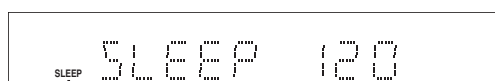

Once the sleep timer is set, the **SLEEP** indicator lights up in the front panel display, and the display returns to the previous display.



### ■ Canceling the sleep timer

Press **SLEEP** on the remote control repeatedly until "SLEEP OFF" appears in the front panel display. After a few seconds, "SLEEP OFF" disappears, and the **SLEEP** indicator turns off and the front panel display returns to the previous display.



The sleep timer setting can also be canceled by pressing **STANDBY** on the remote control (or **STANDBY/ON** on the front panel) to set this unit to the standby mode.

## Dimming the front panel display

You can dim the front panel display so that it does not affect your vision.

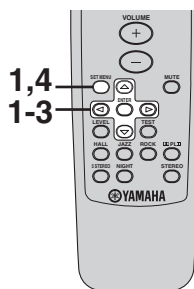

**1** Press **SET MENU** on the remote control repeatedly so that "DIMMER" appears in the front panel display and then press **ENTER**.



**2** Press **◀ / ▶** on the remote control to select the brightness of the front panel display.

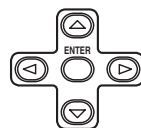

- DIMMER 0** Normal brightness.
- DIMMER -1** Dims the display slightly.
- DIMMER -2** Dims the display more than "DIMMER -1".

**3** Press **/** to exit the "DIMMER" menu.

**4** Press **SET MENU** repeatedly to exit the **SET MENU** function.

## Adjusting speaker levels

Use the test tone to set speaker levels so that the volume from each speaker is identical when heard from your listening position.

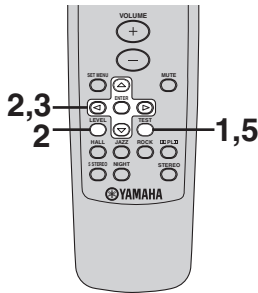

### 1 Press TEST on the remote control.



Each speaker produces the test tone in the following order:

Front left→Center→Front right→Surround right→  
Surround left→Subwoofer→Front left→...

The indicator of the speaker currently outputting the test tone flashes in the front panel display.

### 2 Press LEVEL on the remote control and then press $\Delta / \nabla$ repeatedly to select the speaker you want to adjust.

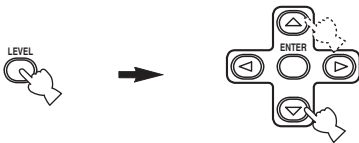

- FL** Front left speaker output level
- CT** Center speaker output level
- FR** Front right speaker output level
- SR** Surround right speaker output level
- SL** Surround left speaker output level
- SW** Subwoofer output level

### 3 Press $\triangleleft / \triangleright$ on the remote control to adjust the speaker output level.

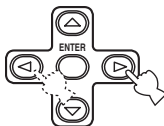

The control range is from +10 dB to -10 dB.

### 4 Repeat steps 2 and 3 to adjust other speaker output levels.

### 5 Press TEST when you have completed your adjustment.



The test tone halts.

#### Notes

- You cannot use the test tone if headphones are connected to the PHONES jack. Remove the headphones from the PHONES jack.
- You cannot adjust “CT”, “SR”, “SL” and “SW” if “CNTR”, “SURR” and “SWFR” are set to “NONE” (page 19).



Depending on the source the unit is reproducing, the speaker levels set with the test tone may not be to your liking. If this is the case, adjust the speaker levels while listening to the source.

#### Adjusting speaker levels during playback

You can adjust the output level of each speaker while listening to a music source.

- 1 Press SET MENU repeatedly so that “SPK LEVEL” appears in the front panel display, and then press ENTER.
- 2 Press  $\Delta / \nabla$  to select a speaker and then  $\triangleleft / \triangleright$  to adjust the speaker output level.
  - Select “FL” to adjust the front left speaker output level.
  - Select “CT” to adjust the center speaker output level.
  - Select “FR” to adjust the front right speaker output level.
  - Select “SR” to adjust the surround right speaker output level.
  - Select “SL” to adjust the surround left speaker output level.
  - Select “SW” to adjust the subwoofer output level.

# TROUBLESHOOTING

Refer to the chart below when this unit does not function properly. If the problem you are experiencing is not listed below or if the instruction below does not help, set this unit to the standby mode, disconnect the power cable, and contact the nearest authorized YAMAHA dealer or service center.

## ■ General

Problem	Cause	Remedy	Refer to page
<b>This unit fails to turn on when STANDBY/ ON (or POWER) is pressed, or enters the standby mode soon after the power has been turned on.</b>	The power cable is not connected or the plug is not completely inserted.	Connect the power cable firmly.	—
	The protection circuitry has been activated.	Make sure all speaker wire connections on this unit and on all speakers are secure and that the wire for each connection does not touch anything other than its respective connection.	11, 12
	This unit has been exposed to a strong external electric shock (such as lightning or strong static electricity).	Set this unit to the standby mode, disconnect the power cable, plug it back in after 30 seconds, then use it normally.	—
<b>No sound</b>	Incorrect input or output cable connections.	Connect the cables properly. If the problem persists, the cables may be defective.	13-16
	The input mode is set to DTS or ANALOG.	Select AUTO.	21
	No appropriate input source has been selected.	Select an appropriate input source with INPUT </> on the front panel (or the input selector buttons on the remote control).	20
	Speaker connections are not secure.	Secure the connections.	11
	The volume is turned down.	Turn up the volume.	—
	The sound is muted.	Press MUTE on the remote control.	21
	The input mode is set to ANALOG while playing a source encoded with a DTS signal.	Set the input mode to DTS.	21
	Signals this unit cannot reproduce are being received from a source component, such as a CD-ROM.	Play a source whose signals can be reproduced by this unit.	—

Problem	Cause	Remedy	Refer to page
<b>The sound suddenly goes off.</b>	The protection circuitry has been activated because of a short circuit, etc.	Check that the speaker wires are not touching each other and then turn this unit back on.	—
	The sleep timer has turned this unit off.	Turn on this unit and play the source again.	—
	The sound is muted.	Press MUTE on the remote control.	21
<b>Only the speaker on one side can be heard.</b>	Incorrect cable connections.	Connect the cables properly. If the problem persists, the cables may be defective.	11
<b>No sound from the front speakers</b>	The output level of the front speakers is set to minimum.	Raise the level of the front speakers.	32
<b>Only the center speaker outputs substantial sound.</b>	When playing a monaural source with a surround mode, the source signal is directed to the center channel, and the front and surround speakers output effect sounds.		
<b>No sound from the effect speakers.</b>	The surround modes are turned off.	Press PROGRAM ◀/▶ on the front panel (or one of the surround mode selector buttons on the remote control) to set this unit to the surround mode.	22
	You are using a source or surround mode combination that does not output sound from all channels.	Try another surround mode.	22
<b>No sound from the center speaker.</b>	The output level of the center speaker is set to minimum.	Raise the level of the center speaker.	32
	“CNTR” is set to NONE.	Select the appropriate setting for the center speaker.	19
<b>No sound from the surround speakers.</b>	The output level of the surround speakers is set to minimum.	Raise the output level of the surround speakers.	32
	“SURR” is set to NONE.	Select the appropriate setting for the surround left and right speakers.	19
<b>No sound from the subwoofer.</b>	The output level of the subwoofer is set to minimum.	Raise the level of the subwoofer.	32
	“SWFR” is set to NONE.	Select “YES”.	19
	The source does not contain low bass signals.		

Problem	Cause	Remedy	Refer to page
<b>Dolby Digital or DTS sources cannot be played. (Dolby Digital or DTS indicator in the front panel display does not light up.)</b>	The connected component is not set to output Dolby Digital or DTS digital signals.	Make an appropriate setting following the operating instructions for your component.	—
	The input mode is set to ANALOG.	Set the input mode to AUTO or DTS.	21
<b>A “humming” sound can be heard.</b>	Incorrect cable connections.	Firmly connect the audio plugs. If the problem persists, the cables may be defective.	—
<b>The volume level cannot be increased, or the sound is distorted.</b>	The component connected to the OUT jacks of this unit is turned off.	Turn on the component.	—
<b>The sound effect cannot be recorded.</b>	It is not possible to record the sound effect with a recording component.		
<b>A source cannot be recorded by an analog component connected to the OUT jacks.</b>	The source component is not connected to the analog IN jacks of this unit.	Connect the source component to the analog IN jacks.	13-16
<b>This unit does not operate properly.</b>	The internal microcomputer has been frozen by an external electric shock (such as lightning or excessive static electricity) or by a power supply with low voltage.	Disconnect the AC power cable from the outlet and then plug it in again after about 30 seconds.	—
<b>There is noise interference from digital or radio frequency equipment, or this unit.</b>	This unit is too close to the digital or high-frequency equipment.	Move this unit further away from such equipment.	—
<b>The picture is disturbed.</b>	The video source uses scrambled or encoded signals to prevent dubbing.		
<b>This unit suddenly turns into the standby mode.</b>	The internal temperature becomes too high and the overheat protection circuitry has been activated.	Wait about 1 hour for this unit to cool down and then turn it back on.	—

## ■ Tuner

Problem		Cause	Remedy	Refer to page
FM	FM stereo reception is noisy.	The characteristics of FM stereo broadcasts may cause this problem when the transmitter is too far away or the antenna input is poor.	Check the antenna connections. Try using a high-quality directional FM antenna.	17
			Use the manual tuning method.	25
	There is distortion, and clear reception cannot be obtained even with a good FM antenna.	There is multipath interference.	Adjust the antenna position to eliminate multipath interference.	—
	The desired station cannot be tuned in with the automatic tuning method.	The signal is too weak.	Use a high-quality directional FM antenna.	17
			Use the manual tuning method.	25
Previously preset stations can no longer be tuned in.	This unit has been disconnected for a long period.	Preset the stations again.	25, 27	
AM	The desired station cannot be tuned in with the automatic tuning method.	The signal is weak or the antenna connections are loose.	Tighten the AM loop antenna connections and orient it for the best reception.	—
			Use the manual tuning method.	25
	There are continuous crackling and hissing noises.	Noises result from lightning, fluorescent lamps, motors, thermostats and other electrical equipment.	Use an outdoor antenna and a ground wire. This will help somewhat, but it is difficult to eliminate all noise.	—
There are buzzing and whining noises.	A TV set is being used nearby.	Move this unit away from the TV.	—	

## ■ Remote control

Problem	Cause	Remedy	Refer to page
The remote control does not work nor function properly.	Wrong distance or angle.	The remote control will function within a maximum range of 6 m (20 ft) and no more than 30 degrees off-axis from the front panel.	7
	Direct sunlight or lighting (from an inverter type of fluorescent lamp, etc.) is striking the remote control sensor of this unit.	Reposition this unit.	—
	The batteries are weak.	Replace all batteries.	3



# RESETTING THE SYSTEM

Use this feature to reset all the parameters of this unit to the initial factory settings.

## Notes

- Be sure this unit is in standby mode.
- This procedure completely resets all the parameters of this unit.
- The initial factory settings are activated next time you turn on this unit.

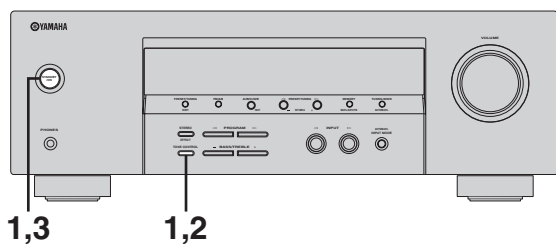

- 1 With this unit in standby mode, hold down TONE CONTROL on the front panel and press STANDBY/ON.**

“RESET>NO” appears in the front panel display.



To cancel the initialization procedure without making any changes, press STANDBY/ON.

- 2 Press TONE CONTROL to select “YES”.**

- 3 Press STANDBY/ON to confirm your selection and set this unit to the standby mode.**

# GLOSSARY

## Audio formats

### ■ Dolby Digital

Dolby Digital is a digital surround sound system that gives you completely independent multi-channel audio. With 3 front channels (left, center, and right), and 2 surround stereo channels, Dolby Digital provides 5 full-range audio channels. With an additional channel especially for bass effects, called LFE (low frequency effect), the system has a total of 5.1-channels (LFE is counted as 0.1 channel). By using 2-channel stereo for the surround speakers, more accurate moving sound effects and surround sound environment are possible than with Dolby Surround. The wide dynamic range (from maximum to minimum volume) reproduced by the 5 full-range channels and the precise sound orientation generated using digital sound processing provide listeners with previously unheard of excitement and realism.

With this unit, any sound environment from monaural up to a 5.1-channel configuration can be freely selected for your enjoyment.

### ■ Dolby Pro Logic II

Dolby Pro Logic II is an improved technique used to decode vast numbers of existing Dolby Surround software. This new technology enables a discrete 5-channel playback with 2 front left and right channels, 1 center channel, and 2 surround left and right channels (instead of only 1 surround channel for conventional Pro Logic technology). Music and Game modes are also available for 2-channel sources in addition to the Movie mode.

### ■ Dolby Surround

Dolby Surround uses a 4 channel analog recording system to reproduce realistic and dynamic sound effects: 2 front left and right channels (stereo), a center channel for dialog (monaural), and a surround channel for special sound effects (monaural). The surround channel reproduces sound within a narrow frequency range.

Dolby Surround is widely used with nearly all video tapes and laser discs, and in many TV and cable broadcasts as well. The Dolby Pro Logic decoder built into this unit employs a digital signal processing system that automatically stabilizes the volume on each channel to enhance moving sound effects and directionality.

### ■ DTS (Digital Theater Systems) Digital Surround

DTS digital surround was developed to replace the analog soundtracks of movies with a 6-channel digital sound track, and is now rapidly gaining popularity in movie theaters around the world. Digital Theater Systems Inc. has developed a home theater system so that you can enjoy the depth of sound and natural spatial representation of DTS digital surround in your home. This system produces practically distortion-free 6-channel sound (technically, a left, right and center channels, 2 surround channels, plus an LFE 0.1 channel as a subwoofer, for a total of 5.1-channels).

## Audio information

### ■ ITU-R

ITU-R is the radio communication sector of the ITU (International Telecommunication Union). ITU-R recommends a standard speaker placement which is used in many critical listening rooms, especially for mastering purposes.

### ■ LFE 0.1 channel

This channel is for the reproduction of low bass signals. The frequency range for this channel is 20 Hz to 120 Hz. This channel is counted as 0.1 because it only enforces a low frequency range compared to the full-range reproduced by the other 5 channels in Dolby Digital or DTS 5.1-channel systems.

### ■ PCM (Linear PCM)

Linear PCM is a signal format under which an analog audio signal is digitized, recorded and transmitted without using any compression. This is used as a method of recording CDs and DVD audio. The PCM system uses a technique for sampling the size of the analog signal per very small unit of time. Standing for “pulse code modulation”, the analog signal is encoded as pulses and then modulated for recording.

### ■ Sampling frequency and number of quantized bits

When digitizing an analog audio signal, the number of times the signal is sampled per second is called the sampling frequency, while the degree of fineness when converting the sound level into a numeric value is called the number of quantized bits.

The range of rates that can be played back is determined based on the sampling rate, while the dynamic range representing the sound level difference is determined by the number of quantized bits. In principle, the higher the sampling frequency, the wider the range of frequencies that can be played back, and the higher the number of quantized bits, the more finely the sound level can be reproduced.

## Video signal information

### ■ Component video signal

With the component video signal system, the video signal is separated into the Y signal for the luminance and the  $P_B$  and  $P_R$  signals for the chrominance. Color can be reproduced more faithfully with this system because each of these signals is independent. The component signal is also called the “color difference signal” because the luminance signal is subtracted from the color signal. A monitor with component input jacks is required in order to use the component signal for output.

### ■ Composite video signal

With the composite video signal system, the video signal is composed of three basic elements of a video picture; color, brightness and synchronization data. A composite video jack on a video component transmits these three elements combined.

# SPECIFICATIONS

## AUDIO SECTION

- Minimum RMS Output Power per channel  
[Front, Center, and Surround]
  - 1 kHz, 0.1% THD, 6  $\Omega$  ..... 80 W
  - 1 kHz, 10% THD, 6  $\Omega$  ..... 110 W[Subwoofer]
  - 50 Hz, 6  $\Omega$  ..... 110 W
- Frequency Response  
CD, etc. to FRONT L/R ..... 10 Hz to 100 kHz, -3 dB
- Total Harmonic Distortion  
1 kHz, CD, etc. to FRONT L/R ..... 0.1%
- Signal to Noise Ratio (IHF-A Network)  
CD, etc. to FRONT L/R, Effect Off ..... 99 dB
- Residual Noise (IHF-A Network) ..... 150  $\mu$ V
- Channel Separation (1 kHz/10 kHz)  
CD, etc. (5.1 k $\Omega$  terminated) to FRONT L/R  
..... 60 dB/45 dB or more
- Tone Control (FRONT L/R)
  - BASS Boost/Cut .....  $\pm$ 10 dB/100 Hz
  - TREBLE Boost/Cut .....  $\pm$ 10 dB/10 kHz
- Phones Output ..... 400 mV/470  $\Omega$
- Input Sensitivity/Input Impedance  
CD, etc. .... 200 mV/47 k $\Omega$
- Output Level/Output Impedance  
OUT ..... 200 mV/1.2 k $\Omega$

## VIDEO SECTION

- Video Signal Type ..... NTSC
- Component Signal Level ..... 1 V<sub>p-p</sub>/75  $\Omega$
- Signal to Noise Ratio ..... 50 dB or more
- Frequency Response (MONITOR OUT)
  - Composite ..... 5 Hz to 10 MHz, -3 dB
  - Component ..... 5 Hz to 60 MHz, -3 dB

## FM SECTION

- Tuning Range ..... 87.5 to 107.9 MHz
- 50 dB Quieting Sensitivity (IHF, 100% mod.)  
Mono ..... 30 dB
- Signal to Noise Ratio (IHF)  
Mono/Stereo ..... 73 dB/70 dB
- Harmonic Distortion (1 kHz)  
Mono/Stereo ..... 0.5%/0.8%

## AM SECTION

- Tuning Range ..... 530 to 1710 kHz

## GENERAL

- Power Supply ..... AC 120 V, 60 Hz
- Power Consumption ..... 220 W/240 VA
- Standby Power Consumption ..... 1 W
- Dimensions (W x H x D) ..... 435 x 151 x 303 mm  
(17-1/8" x 5-15/16" x 11-15/16")
- Weight ..... 8.0 kg (17 lbs 10 oz)

\* Specifications are subject to change without notice.



© 2006 YAMAHA CORPORATION All rights reserved.

**YAMAHA ELECTRONICS CORPORATION, USA** 6660 ORANGETHORPE AVE., BUENA PARK, CALIF. 90620, U.S.A.  
**YAMAHA CANADA MUSIC LTD.** 135 MILNER AVE., SCARBOROUGH, ONTARIO M1S 3R1, CANADA  
**YAMAHA ELECTRONIK EUROPA G.m.b.H.** SIEMENSSTR. 22-34, 25462 RELINGEN BEI HAMBURG, GERMANY  
**YAMAHA ELECTRONIQUE FRANCE S.A.** RUE AMBROISE CROIZAT BP70 CROISSY-BEAUBOURG 77312 MARNE-LA-VALLEE CEDEX02, FRANCE  
**YAMAHA ELECTRONICS (UK) LTD.** YAMAHA HOUSE, 200 RICKMANSWORTH ROAD WATFORD, HERTS WD18 7GQ, ENGLAND  
**YAMAHA SCANDINAVIA A.B.** J A WETTERGRENS GATA 1, BOX 30053, 400 43 VÄSTRA FRÖLUNDA, SWEDEN  
**YAMAHA MUSIC AUSTRALIA PTY, LTD.** 17-33 MARKET ST., SOUTH MELBOURNE, 3205 VIC., AUSTRALIA

**YAMAHA CORPORATION**  
Printed in China ◀ CQX1A1074Z

## Free Manuals Download Website

<http://myh66.com>

<http://usermanuals.us>

<http://www.somanuals.com>

<http://www.4manuals.cc>

<http://www.manual-lib.com>

<http://www.404manual.com>

<http://www.luxmanual.com>

<http://aubethermostatmanual.com>

Golf course search by state

<http://golfingnear.com>

Email search by domain

<http://emailbydomain.com>

Auto manuals search

<http://auto.somanuals.com>

TV manuals search

<http://tv.somanuals.com>