



HTR-5890

AV Receiver

OWNER'S MANUAL

IMPORTANT SAFETY INSTRUCTIONS

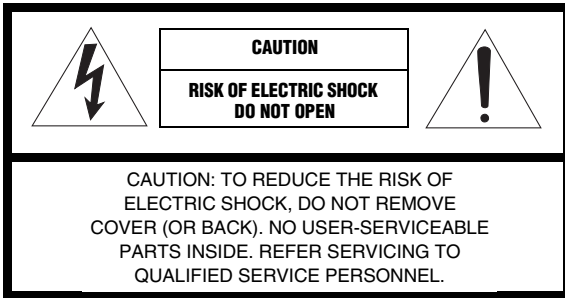

• Explanation of Graphical Symbols



The lightning flash with arrowhead symbol, within an equilateral triangle, is intended to alert you to the presence of uninsulated “dangerous voltage” within the product’s enclosure that may be of sufficient magnitude to constitute a risk of electric shock to persons.



The exclamation point within an equilateral triangle is intended to alert you to the presence of important operating and maintenance (servicing) instructions in the literature accompanying the appliance.

- 1 Read Instructions – All the safety and operating instructions should be read before the product is operated.
- 2 Retain Instructions – The safety and operating instructions should be retained for future reference.
- 3 Heed Warnings – All warnings on the product and in the operating instructions should be adhered to.
- 4 Follow Instructions – All operating and use instructions should be followed.
- 5 Cleaning – Unplug this product from the wall outlet before cleaning. Do not use liquid cleaners or aerosol cleaners. Use a clean, dry cloth for cleaning.
- 6 Attachments – Do not use attachments not recommended by the product manufacturer as they may cause hazards.
- 7 Water and Moisture – Do not use this product near water – for example, near a bath tub, wash bowl, kitchen sink, or laundry tub; in a wet basement; or near a swimming pool; and the like.
- 8 Accessories – Do not place this product on an unstable cart, stand, tripod, bracket, or table. The product may fall, causing serious injury to a child or adult, and serious damage to the product. Use only with a cart, stand, tripod, bracket, or table recommended by the manufacturer, or sold with the product. Any mounting of the product should follow the manufacturer’s instructions, and should use a mounting accessory recommended by the manufacturer.
- 9 A product and cart combination should be moved with care. Quick stops, excessive force, and uneven surfaces may cause the product and cart combination to overturn.



- 10 Ventilation – Slots and openings in the cabinet are provided for ventilation and to ensure reliable operation of the product and to protect it from overheating, and these openings must not be blocked or covered. The openings should never be blocked by placing the product on a bed, sofa, rug, or other similar surface. This product should not be placed in a built-in installation such as a bookcase or rack unless proper ventilation is provided or the manufacturer’s instructions have been adhered to.
- 11 Power Sources – This product should be operated only from the type of power source indicated on the marking label. If you are not sure of the type of power supply to your home, consult your product dealer or local power company. For products intended to operate from battery power, or other sources, refer to the operating instructions.
- 12 Grounding or Polarization – This product may be equipped with a polarized alternating current line plug (a plug having one blade wider than the other). This plug will fit into the power outlet only one way. This is a safety feature. If you are unable to insert the plug fully into the outlet, try reversing the plug. If the plug should still fail to fit, contact your electrician to replace your obsolete outlet. Do not defeat the safety purpose of the polarized plug.
- 13 Power-Cord Protection – Power-supply cords should be routed so that they are not likely to be walked on or pinched by items placed upon or against them, paying particular attention to cords at plugs, convenience receptacles, and the point where they exit from the product.
- 14 Lightning – For added protection for this product during a lightning storm, or when it is left unattended and unused for long periods of time, unplug it from the wall outlet and disconnect the antenna or cable system. This will prevent damage to the product due to lightning and power-line surges.
- 15 Power Lines – An outside antenna system should not be located in the vicinity of overhead power lines or other electric light or power circuits, or where it can fall into such power lines or circuits. When installing an outside antenna system, extreme care should be taken to keep from touching such power lines or circuits as contact with them might be fatal.
- 16 Overloading – Do not overload wall outlets, extension cords, or integral convenience receptacles as this can result in a risk of fire or electric shock.
- 17 Object and Liquid Entry – Never push objects of any kind into this product through openings as they may touch dangerous voltage points or short-out parts that could result in a fire or electric shock. Never spill liquid of any kind on the product.
- 18 Servicing – Do not attempt to service this product yourself as opening or removing covers may expose you to dangerous voltage or other hazards. Refer all servicing to qualified service personnel.
- 19 Damage Requiring Service – Unplug this product from the wall outlet and refer servicing to qualified service personnel under the following conditions:
 - a) When the power-supply cord or plug is damaged,
 - b) If liquid has been spilled, or objects have fallen into the product,
 - c) If the product has been exposed to rain or water,

- d) If the product does not operate normally by following the operating instructions. Adjust only those controls that are covered by the operating instructions as an improper adjustment of other controls may result in damage and will often require extensive work by a qualified technician to restore the product to its normal operation,
 - e) If the product has been dropped or damaged in any way, and
 - f) When the product exhibits a distinct change in performance - this indicates a need for service.
- 20 Replacement Parts** – When replacement parts are required, be sure the service technician has used replacement parts specified by the manufacturer or have the same characteristics as the original part. Unauthorized substitutions may result in fire, electric shock, or other hazards.
- 21 Safety Check** – Upon completion of any service or repairs to this product, ask the service technician to perform safety checks to determine that the product is in proper operating condition.
- 22 Wall or Ceiling Mounting** – The unit should be mounted to a wall or ceiling only as recommended by the manufacturer.
- 23 Heat** – The product should be situated away from heat sources such as radiators, heat registers, stoves, or other products (including amplifiers) that produce heat.

- 24 Outdoor Antenna Grounding** – If an outside antenna or cable system is connected to the product, be sure the antenna or cable system is grounded so as to provide some protection against voltage surges and built-up static charges. Article 810 of the National Electrical Code, ANSI/NFPA 70, provides information with regard to proper grounding of the mast and supporting structure, grounding of the lead-in wire to an antenna discharge unit, size of grounding conductors, location of antenna discharge unit, connection to grounding electrodes, and requirements for the grounding electrode.

EXAMPLE OF ANTENNA GROUNDING

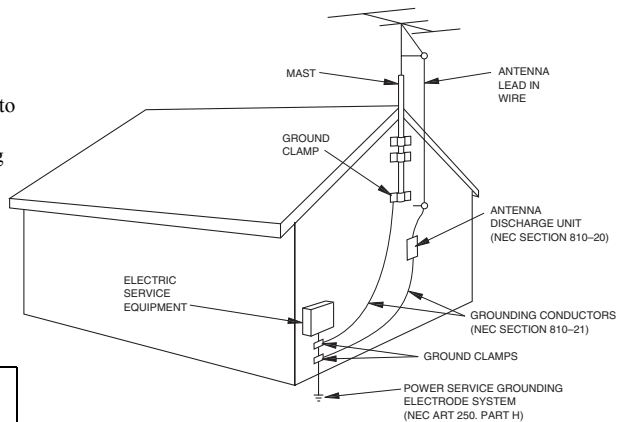

Note to CATV system installer:

This reminder is provided to call the CATV system installer’s attention to Article 820-40 of the NEC that provides guidelines for proper grounding and, in particular, specifies that the cable ground shall be connected to the grounding system of the building, as close to the point of cable entry as practical.

FCC INFORMATION (for US customers)

1 IMPORTANT NOTICE: DO NOT MODIFY THIS UNIT!

This product, when installed as indicated in the instructions contained in this manual, meets FCC requirements. Modifications not expressly approved by Yamaha may void your authority, granted by the FCC, to use the product.

- 2 IMPORTANT:** When connecting this product to accessories and/or another product use only high quality shielded cables. Cable/s supplied with this product MUST be used. Follow all installation instructions. Failure to follow instructions could void your FCC authorization to use this product in the USA.

- 3 NOTE:** This product has been tested and found to comply with the requirements listed in FCC Regulations, Part 15 for Class “B” digital devices. Compliance with these requirements provides a reasonable level of assurance that your use of this product in a residential environment will not result in harmful interference with other electronic devices.

This equipment generates/uses radio frequencies and, if not installed and used according to the instructions found in the users manual, may cause interference harmful to the operation of other electronic devices.

Compliance with FCC regulations does not guarantee that interference will not occur in all installations. If this product is found to be the source of interference, which can be determined by turning the unit “OFF” and “ON”, please try to eliminate the problem by using one of the following measures:

Relocate either this product or the device that is being affected by the interference.

Utilize power outlets that are on different branch (circuit breaker or fuse) circuits or install AC line filter/s.

In the case of radio or TV interference, relocate/reorient the antenna. If the antenna lead-in is 300 ohm ribbon lead, change the lead-in to coaxial type cable.

If these corrective measures do not produce satisfactory results, please contact the local retailer authorized to distribute this type of product. If you can not locate the appropriate retailer, please contact Yamaha Electronics Corp., U.S.A. 6660 Orangethorpe Ave, Buena Park, CA 90620.

The above statements apply ONLY to those products distributed by Yamaha Corporation of America or its subsidiaries.

CAUTION: READ THIS BEFORE OPERATING YOUR UNIT.

- 1 To assure the finest performance, please read this manual carefully. Keep it in a safe place for future reference.
- 2 Install this sound system in a well ventilated, cool, dry, clean place — away from direct sunlight, heat sources, vibration, dust, moisture, and/or cold. Allow ventilation space of at least 30 cm on the top, 20 cm on the left and right, and 20 cm on the back of this unit.
- 3 Locate this unit away from other electrical appliances, motors, or transformers to avoid humming sounds.
- 4 Do not expose this unit to sudden temperature changes from cold to hot, and do not locate this unit in an environment with high humidity (i.e. a room with a humidifier) to prevent condensation inside this unit, which may cause an electrical shock, fire, damage to this unit, and/or personal injury.
- 5 Avoid installing this unit where foreign object may fall onto this unit and/or this unit may be exposed to liquid dripping or splashing. On the top of this unit, do not place:
 - Other components, as they may cause damage and/or discoloration on the surface of this unit.
 - Burning objects (i.e. candles), as they may cause fire, damage to this unit, and/or personal injury.
 - Containers with liquid in them, as they may fall and liquid may cause electrical shock to the user and/or damage to this unit.
- 6 Do not cover this unit with a newspaper, tablecloth, curtain, etc. in order not to obstruct heat radiation. If the temperature inside this unit rises, it may cause fire, damage to this unit, and/or personal injury.
- 7 Do not plug in this unit to a wall outlet until all connections are complete.
- 8 Do not operate this unit upside-down. It may overheat, possibly causing damage.
- 9 Do not use force on switches, knobs and/or cords.
- 10 When disconnecting the power cord from the wall outlet, grasp the plug; do not pull the cord.
- 11 Do not clean this unit with chemical solvents; this might damage the finish. Use a clean, dry cloth.
- 12 Only voltage specified on this unit must be used. Using this unit with a higher voltage than specified is dangerous and may cause fire, damage to this unit, and/or personal injury. YAMAHA will not be held responsible for any damage resulting from use of this unit with a voltage other than specified.
- 13 To prevent damage by lightning, disconnect the power cord from the wall outlet during an electrical storm.
- 14 Do not attempt to modify or fix this unit. Contact qualified YAMAHA service personnel when any service is needed. The cabinet should never be opened for any reasons.
- 15 When not planning to use this unit for long periods of time (i.e. vacation), disconnect the AC power plug from the wall outlet.
- 16 Be sure to read the “TROUBLESHOOTING” section on common operating errors before concluding that this unit is faulty.
- 17 Before moving this unit, press STANDBY/ON to set this unit in the standby mode, and disconnect the AC power plug from the wall outlet.

WARNING

TO REDUCE THE RISK OF FIRE OR ELECTRIC SHOCK, DO NOT EXPOSE THIS UNIT TO RAIN OR MOISTURE.

This unit is not disconnected from the AC power source as long as it is connected to the wall outlet, even if this unit itself is turned off. This state is called the standby mode. In this state, this unit is designed to consume a very small quantity of power.

FOR CANADIAN CUSTOMERS

To prevent electric shock, match wide blade of plug to wide slot and fully insert.

This Class B digital apparatus complies with Canadian ICES-003.

IMPORTANT

Please record the serial number of this unit in the space below.

MODEL:

Serial No.:

The serial number is located on the rear of the unit.

Retain this Owner's Manual in a safe place for future reference.

CONTENTS

INTRODUCTION

FEATURES	2
GETTING STARTED	3
Supplied accessories.....	3
Installing batteries in the remote control.....	3
CONTROLS AND FUNCTIONS	4
Front panel.....	4
Remote control.....	6
Using the remote control.....	8
Front panel display.....	9
Rear panel.....	11

PREPARATION

SPEAKER SETUP	12
Speaker placement.....	12
Speaker connections.....	13
CONNECTIONS	17
Before connecting components.....	17
Connecting video components.....	18
Connecting audio components.....	21
Connecting the antennas.....	23
Connecting the power supply cord.....	24
Speaker impedance setting.....	25
Turning on the power.....	25
AUTO SETUP	26
Introduction.....	26
Optimizer microphone setup.....	26
Starting the setup.....	27
BASIC SETUP	31
Using BASIC MENU.....	31
PLAYBACK	33

BASIC OPERATION

Basic operations.....	33
Selecting sound field programs.....	34
Additional operations.....	35
Selecting input modes.....	40
TUNING	41
Automatic and manual tuning.....	41
Presetting stations.....	42
Selecting preset stations.....	44
Exchanging preset stations.....	44
RECORDING	45

SOUND FIELD PROGRAMS

SOUND FIELD PROGRAM

DESCRIPTIONS	46
For movie/video sources.....	46
For music sources.....	49

ADVANCED OPERATION

ADVANCED OPERATIONS	50
Selecting the OSD mode.....	50
Using the sleep timer.....	50
Manually adjusting speaker levels.....	51
Using the test tone.....	52
SET MENU	53
Using SET MENU.....	54
Using SOUND MENU.....	55
Using INPUT MENU.....	60
Using OPTION MENU.....	62
REMOTE CONTROL FEATURES	65
Control area.....	65
Setting remote control codes.....	66
Programming codes from other remote controls (Learn).....	68
Changing source names in the display window.....	70
Using the Macro feature.....	71
Clearing function sets.....	73
Clearing individual functions.....	74
Controlling each component.....	76
ZONE 2/ZONE 3	77
Zone 2/Zone 3 connections.....	77
Remote controlling Zone 2/Zone 3.....	78

ADDITIONAL INFORMATION

EDITING SOUND FIELD PARAMETERS	80
What is a sound field?.....	80
Changing parameter settings.....	80
SOUND FIELD PARAMETER DESCRIPTIONS	82
TROUBLESHOOTING	86
GLOSSARY	91
Audio formats.....	91
Sound field programs.....	92
Audio information.....	93
Video signal information.....	94
SPECIFICATIONS	95

FEATURES

Built-in 7-channel power amplifier

- ◆ Minimum RMS output power (0.04% THD, 20 Hz – 20 kHz, 8 Ω)
Front: 120 W + 120 W
Center: 120 W
Surround: 120 W + 120 W
Surround Back: 120 W + 120 W

Sound field features

- ◆ Proprietary YAMAHA technology for the creation of sound fields
- ◆ THX Select
- ◆ Dolby Digital/Dolby Digital EX decoder
- ◆ DTS/DTS-ES Matrix 6.1, Discrete 6.1, DTS Neo:6 decoder, DTS 96/24
- ◆ Dolby Pro Logic/Dolby Pro Logic II/Dolby Pro Logic IIx Decoder
- ◆ Virtual CINEMA DSP
- ◆ SILENT CINEMA™

Sophisticated AM/FM tuner

- ◆ 40-station random access preset tuning
- ◆ Automatic preset tuning
- ◆ Preset station shifting capability (preset editing)

Other features

- ◆ YPAO: YAMAHA Parametric Room Acoustic Optimizer for automatic speaker setup
- ◆ 192-kHz/24-bit D/A converter
- ◆ SET MENU to optimize this unit for your audio/video system
- ◆ 6 or 8-channel additional input jacks for discrete multi channel input
- ◆ On-screen display function helpful in controlling this unit
- ◆ PURE DIRECT for pure fidelity sound with analog and PCM sources
- ◆ S-video signal input/output capability
- ◆ Component video input/output capability
- ◆ Video signal conversion (composite video ↔ S-video → component video) capability for monitor out
- ◆ Optical and coaxial digital audio signal jacks
- ◆ Sleep timer
- ◆ Cinema and music night listening mode
- ◆ Remote control with preset remote control codes and learning/macro capability
- ◆ Zone 2/Zone 3 custom installation facility

-  indicates a tip for your operation.
- Some operations can be performed by using either the buttons on the main unit or on the remote control. In cases when the button names differ between the main unit and the remote control, the button name on the remote control is given in parentheses.
- This manual is printed prior to production. Design and specifications are subject to change in part as a result of improvements, etc. In case of differences between the manual and product, the product has priority.



Manufactured under license from Dolby Laboratories. “Dolby”, “Pro Logic”, “Surround EX”, and the double-D symbol are trademarks of Dolby Laboratories.

“SILENT CINEMA” is a trademark of YAMAHA CORPORATION.



“DTS”, “DTS-ES”, “Neo:6” and “DTS 96/24” are trademarks of Digital Theater Systems, Inc.



THX and the THX logo are registered trademarks of THX Ltd. Surround EX is a jointly developed technology of THX and Dolby Laboratories, Inc. and is a trademark of Dolby Laboratories, Inc. All rights reserved. Used under authorization.

We Want You Listening For A Lifetime

YAMAHA and the Electronic Industries Association’s Consumer Electronics Group want you to get the most out of your equipment by playing it at a safe level. One that lets the sound come through loud and clear without annoying blaring or distortion – and, most importantly, without affecting your sensitive hearing. Since hearing damage from loud sounds is often undetectable until it is too late, YAMAHA and the Electronic Industries Association’s Consumer Electronics Group recommend you to avoid prolonged exposure from excessive volume levels.



GETTING STARTED

Supplied accessories

Please check that you received all of the following parts.

Remote control

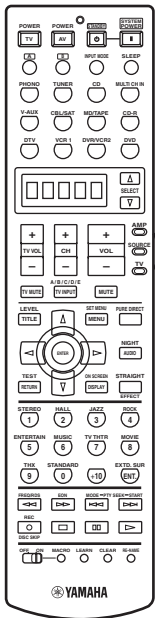

Batteries (4)
(AAA, R03, UM-4)

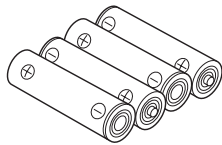

Power Cord

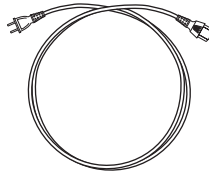

Indoor FM antenna

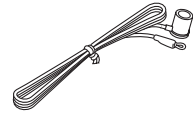

Speaker terminal wrench

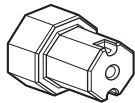

Optimizer microphone

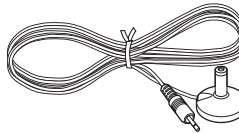

AM loop antenna



Installing batteries in the remote control

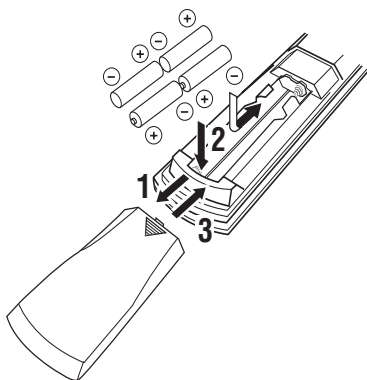

1 Press the ▼ part and slide the battery compartment cover off.

2 Insert the four supplied batteries (AAA, R03, UM-4) according to the polarity markings on the inside of the battery compartment.

3 Slide the cover back until it snaps into place.

Notes on batteries

- Change all of the batteries if you notice conditions such as the operation range of the remote control decreases, the indicator does not flash, or its light or display window become dim.
- Do not use old batteries together with new ones.
- Do not use different types of batteries (such as alkaline and manganese batteries) together. Read the packaging carefully as these different types of batteries may have the same shape and color.
- If the batteries have leaked, dispose of them immediately. Avoid touching the leaked material or letting it come into contact with clothing, etc. Clean the battery compartment thoroughly before installing new batteries.
- Do not throw away batteries with general house waste; dispose of them correctly in accordance with your local regulations.

If the remote control is without batteries for more than 2 minutes, or if exhausted batteries remain in the remote control, the contents of the memory may be cleared. When the memory is cleared, insert new batteries, set up the remote control code and program any acquired functions that may have been cleared.

CONTROLS AND FUNCTIONS

Front panel

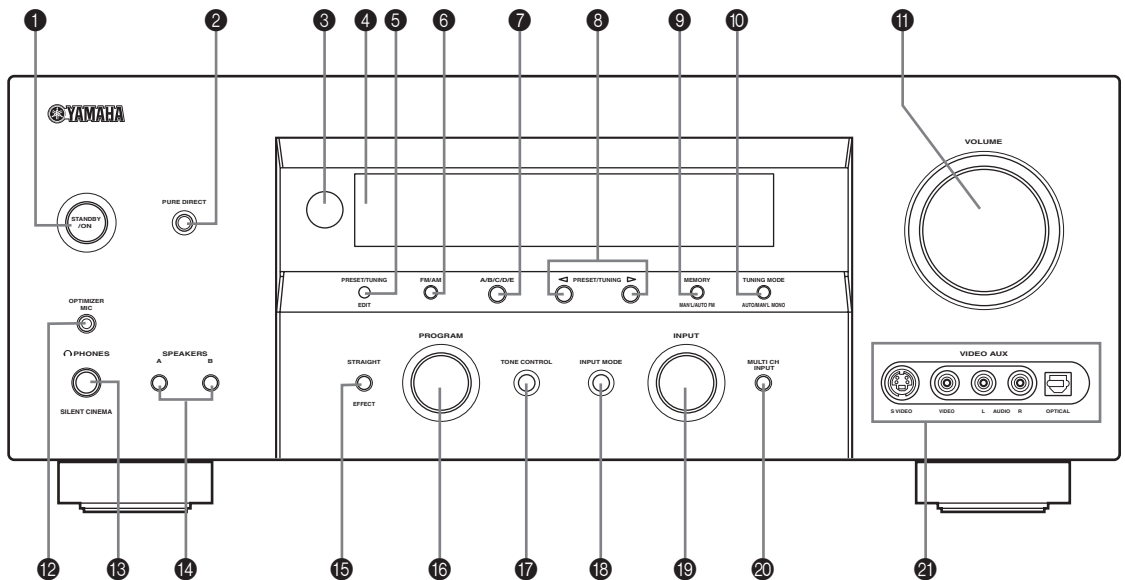

1 STANDBY/ON

Turns on this unit or sets it to the standby mode. When you turn on this unit, you will hear a click and there will be a 6 to 7-second delay before this unit can reproduce sound.

Note

In standby mode, this unit consumes a small amount of power in order to receive infrared-signals from the remote control.

2 PURE DIRECT

Turns on or off the PURE DIRECT mode. Lights up when turned on (see page 37).

3 Remote control sensor

Receives signals from the remote control.

4 Front panel display

Shows information about the operational status of this unit.

5 PRESET/TUNING EDIT

Switches the function of PRESET/TUNING </> between selecting preset station numbers and tuning.

6 FM/AM

Switches the reception band between FM and AM.

7 A/B/C/D/E

Selects one of the 5 preset station groups (A to E).

8 PRESET/TUNING </>

Selects preset station number 1 through 8 when a colon (:) is displayed next to the band indication in the front panel display.

Selects the tuning frequency when the colon (:) is not displayed.

9 MEMORY (MAN'L/AUTO FM)

Stores a station in the memory. Hold down this button for more than 3 seconds to start automatic preset tuning.

10 TUNING MODE (AUTO/MAN'L MONO)

Switches the tuning mode between automatic (AUTO indicator on) and manual (AUTO indicator off).

11 VOLUME

Controls the output level of all audio channels. This does not affect the REC OUT level.

12 OPTIMIZER MIC jack

Use to connect and input audio signals from the supplied microphone for use with the AUTO SETUP function (see page 26).

13 PHONES (SILENT CINEMA) jack

Outputs audio signals for listening with headphones.

When you connect headphones, no signals are output to the PRE OUT jacks or to the speakers.

All Dolby Digital and DTS audio signals are mixed down to the left and right headphone channels.

14 SPEAKERS A/B

Turn on or off the set of front speakers connected to the A and/or B terminals on the rear panel each time the corresponding button is pressed.

15 STRAIGHT/EFFECT

Switches the sound fields off or on. When STRAIGHT is selected, input signals (2-channel or multi-channel) are output directly from their respective speakers without effect processing.

16 PROGRAM

Use to select sound field programs or adjust bass/treble balance (in conjunction with TONE CONTROL).

17 TONE CONTROL

Use to adjust the bass/treble balance for the front left/right and center channels (see page 35).

18 INPUT MODE

Sets the priority (AUTO, DTS, ANALOG) for the type of signals received when one component is connected to two or more of this unit's input jacks (see page 40).

19 INPUT selector

Selects the input source you want to listen to or watch.

20 MULTI CH INPUT

Selects the source connected to the MULTI CH INPUT jacks. When selected, the MULTI CH INPUT source takes priority over the source selected with INPUT (or the input selector buttons on the remote control).

21 VIDEO AUX jacks

Input audio and video signals from an external source such as a game console. To reproduce source signals from these jacks, select V-AUX as the input source.

Remote control

This section describes the function of each control on the remote control used to control this unit. To operate other components, see “REMOTE CONTROL FEATURES” on page 65.

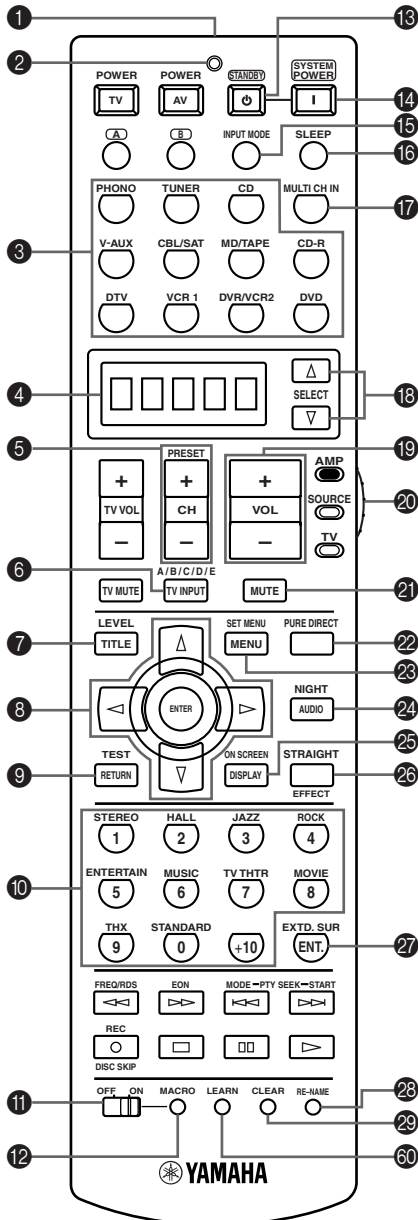

1 Infrared window

Outputs infrared control signals. Aim this window at the component you want to operate.

2 Transmission indicator

Flashes while the remote control is sending signals.

3 Input selector buttons

Select the input source and change the control area.

4 Display window

Shows the name of the selected source component that you can control.

5 PRESET +/-

Selects preset station numbers when this unit is in tuner mode.

6 A/B/C/D/E

Selects preset groups when this unit is in tuner mode.

7 LEVEL

Selects the speaker channel to be adjusted and sets the level.

8 Cursor buttons Δ / ∇ / \triangleleft / \triangleright / ENTER

Use to select and adjust DSP program parameters or SET MENU items.

9 TEST

Outputs the test tone to adjust the speaker levels.

10 Sound field program/Numeric buttons

Use to select sound field programs or input numbers. Use numbers 1 through 8 to select preset stations when this unit is in tuner mode.

11 MACRO ON/OFF

Turns the macro function on and off.

12 MACRO

Use to program a series of operations for control by a single button (see page 71).

13 STANDBY

Sets this unit in the standby mode.

14 SYSTEM POWER

Turns on the power of this unit.

15 INPUT MODE

Sets the priority (AUTO, DTS, ANALOG) for the type of signals received when one component is connected to two or more of this unit’s input jacks (see page 40).

16 SLEEP

Sets the sleep timer.

17 MULTI CH IN

Selects MULTI CH INPUT when using an external decoder (etc.).

18 SELECT Δ/∇

Selects another component that you can control independently of the input component selected with the input selector buttons.

19 VOL +/-

Increases or decreases the volume level.

20 AMP/SOURCE/TV

Selects the component you want to control with the remote control.

AMP: Set to this position to operate this unit.

SOURCE: Set to this position to operate the component selected with an input selector button.

TV: Set to this position to operate the television.

To set the remote control codes for components, see page 66.

21 MUTE

Mutes the sound. Press again to restore the audio output to the previous volume level. You can adjust how much the mute function reduces the output volume in the MUTE menu of the SET MENU mode (see page 59).

22 PURE DIRECT

Turns on or off PURE DIRECT mode (see page 37).

23 SET MENU

Selects the SET MENU mode.

24 NIGHT

Turns on or off the night listening modes (see page 38).

25 ON SCREEN

Selects the display mode of the on-screen display (OSD) this unit sends to your monitor.

26 STRAIGHT/EFFECT

Switches the sound fields off or on. When STRAIGHT is selected, input signals (2-channel or multi-channel) are output directly from their respective speakers without effect processing.

27 EXT.D. SUR

Switches between 5.1 or 6.1/7.1 channel playback of multi-channel software.

28 RE-NAME

Used to change the input source name in the display window (see page 70).

29 CLEAR

Used to clear functions acquired when using the learn and rename features, or setting remote control codes (see page 73).

30 LEARN

Used to set up the remote control code or program functions from other remote controls (see pages 66 and 68).

Using the remote control

The remote control transmits a directional infrared beam. Be sure to aim the remote control directly at the remote control sensor on the main unit during operation.

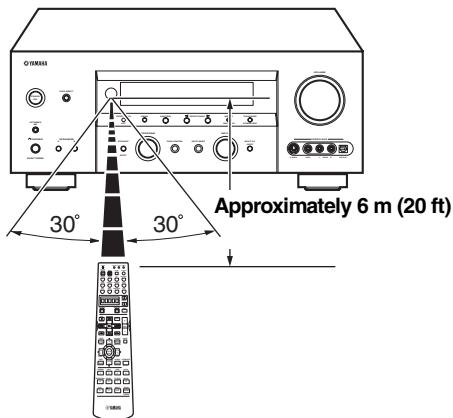

■ Handling the remote control

- Do not spill water or other liquids on the remote control.
- Do not drop the remote control.
- Do not leave or store the remote control in the following types of conditions:
 - high humidity such as near a bath
 - high temperature such as near a heater or stove
 - extremely low temperature
 - dusty places

Front panel display

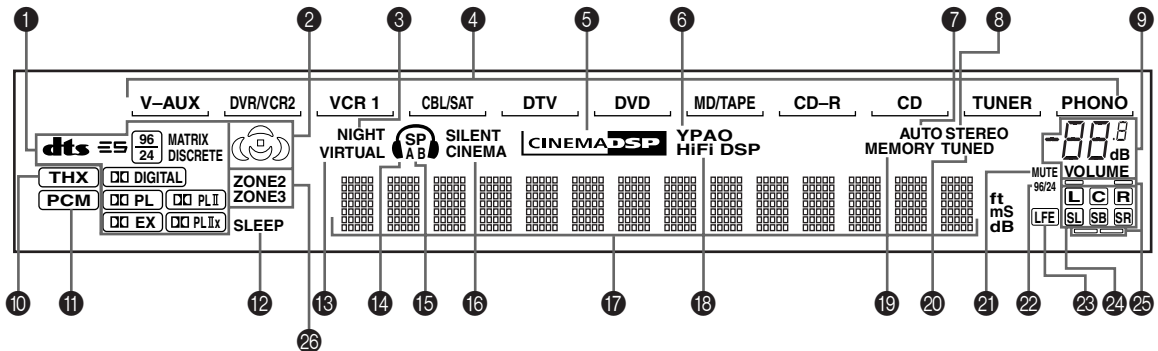

❶ Decoder indicators

When any of this unit's decoders function, the respective indicator lights up.

❷ Sound field indicators

Light to indicate the active DSP sound fields.

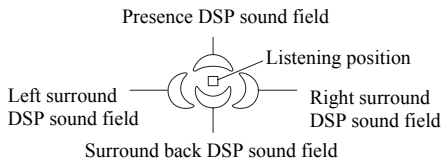

❸ NIGHT indicator

Lights up when you select night listening mode.

❹ Input source indicators

A cursor lights to show the current input source.

❺ CINEMA DSP indicator

Lights up when you select a CINEMA DSP sound field program.

❻ YPAO indicator

Lights up during the auto setup procedure and when the auto setup speaker settings are used without any modifications.

❼ AUTO indicator

Lights up when this unit is in the automatic tuning mode.

❽ STEREO indicator

Lights up when this unit is receiving a stereo signal for an FM stereo broadcast while the AUTO indicator is lit.

❾ VOLUME level indicator

Indicates the volume level.

❿ THX indicator

Lights up when a THX program is selected.

⓫ PCM indicator

Lights up when this unit is reproducing PCM (pulse code modulation) digital audio signals.

⓬ SLEEP indicator

Lights up while the sleep timer is on.

⓭ VIRTUAL indicator

Lights up when Virtual CINEMA DSP is active (see page 39).

⓮ Headphones indicator

Lights up when headphones are connected.

⓯ SP A B indicators

Light up according to the set of front speakers selected. Both indicators light up when both sets of speakers are selected, or when bi-wiring.

⓰ SILENT CINEMA indicator

Lights up when headphones are connected and a sound field program is selected (see page 35).

⓱ Multi-information display

Shows the current sound field program name and other information when adjusting or changing settings.

⓲ HiFi DSP indicator

Lights up when you select a HiFi DSP sound field program.

⓳ MEMORY indicator

Blinks to show a station can be stored.

⓴ TUNED indicator

Lights up when this unit is tuned into a station.

⓵ MUTE indicator

Blinks while the MUTE function is on.

22 96/24 indicator

Lights up when a DTS 96/24 signal is input to this unit.

23 LFE indicator

Lights up when the input signal contains an LFE signal.

24 Input channel indicators

Indicate the channel components of current digital input signal.

25 Presence and surround back speaker indicators

Indicate the connection of presence and/or surround back speakers when using the SPEAKERS setting (page 32) or SP LEVEL setting (page 57).

26 ZONE 2/ZONE 3 indicators

Light up when Zone 2 or Zone 3 power is on.

Rear panel

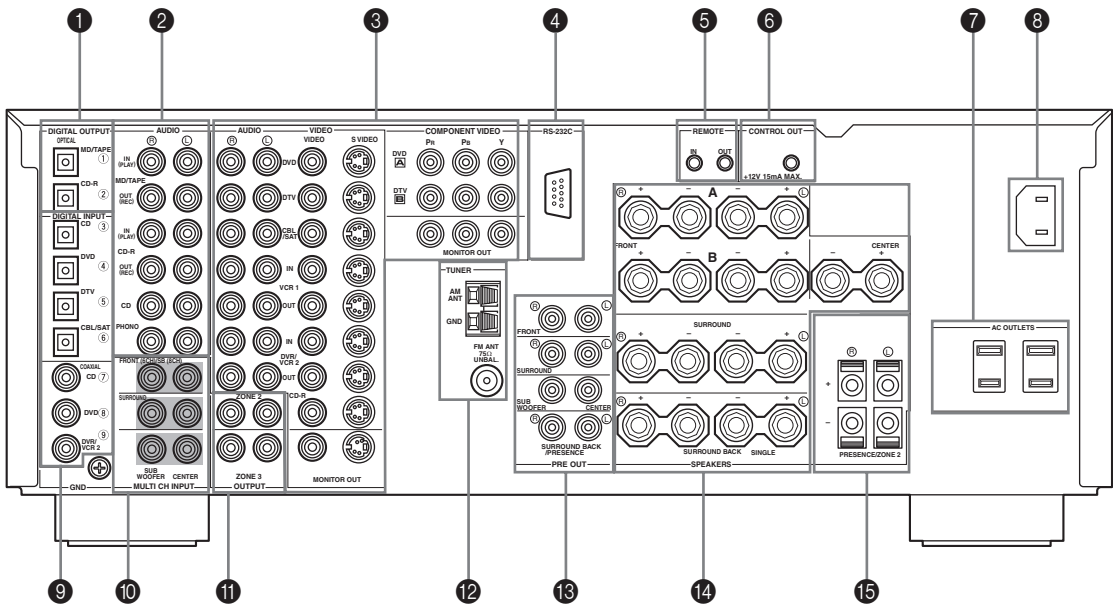

1 DIGITAL OUTPUT jacks

See page 21 for details.

2 Audio component jacks

See page 21 for connection information.

3 Video component jacks

See pages 18 and 20 for connection information.

4 RS-232C terminal

This is a control expansion terminal for commercial use. Consult your dealer for details.

5 REMOTE IN/OUT jacks

See page 77 for connection information.

6 CONTROL OUT jack

See page 77 for connection information.

7 AC OUTLET(S)

Use to supply power to your other A/V components (see page 24).

8 AC INLET

Use this inlet to plug in the supplied power cable (see page 24).

9 DIGITAL INPUT jacks

See pages 18, 20 and 21 for details.

10 MULTI CH INPUT jacks

See page 19 for connection information.

11 ZONE 2/ZONE 3 OUTPUT jacks

See page 77 for connection information.

12 Antenna terminals

See page 23 for connection information.

13 PRE OUT jacks

See page 22 for connection information.

14 Speaker terminals

See page 13 for connection information.

15 PRESENCE/ZONE 2 speaker terminals

See page 14 for connection information.

SPEAKER SETUP

Speaker placement

For best results, place the speakers as illustrated below.

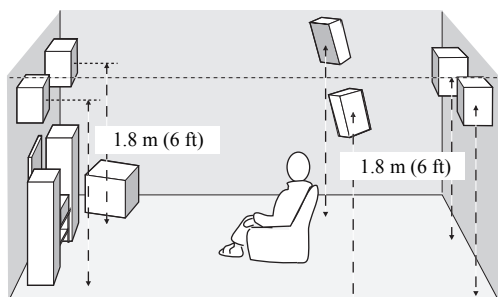
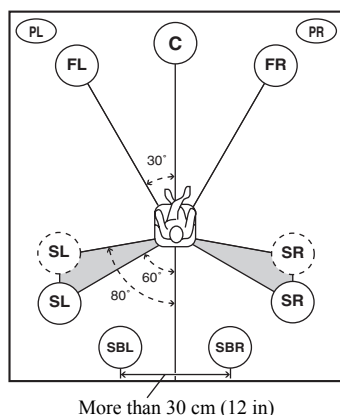

The illustrations show the standard speaker setting recommended by the ITU-R (see page 93). You can use it to enjoy CINEMA DSP, multi-channel audio sources, and THX.

Front speakers (FR and FL)

The front speakers are used for the main source sound plus effect sounds. Place these speakers an equal distance from the ideal listening position. The distance of each speaker from each side of the video monitor should be the same.

Center speaker (C)

The center speaker is for the center channel sounds (dialog, vocals, etc.). If for some reason it is not practical to use a center speaker, you can do without it. Best results, however, are obtained with the full system. Align the front face of the center speaker with the front face of your video monitor. Place the speaker centrally between the front speakers and as close to the monitor as possible, such as directly over or under it.

Surround speakers (SR and SL)

The surround speakers are used for effect and surround sounds. Place these speakers behind your listening position, facing slightly inwards, about 1.8 m (6 ft) above the floor.

Surround back speakers (SBR and SBL)

The surround back speakers supplement the surround speakers and provide for more realistic front-to-back transitions. Place these speakers directly behind the listening position and at the same height as the surround speakers. They should be positioned at least 30 cm (12 in) apart. Ideally, they should be positioned at the same width as the front speakers.

Subwoofer

The use of a subwoofer, such as the YAMAHA Active Servo Processing Subwoofer System, is effective not only for reinforcing bass frequencies from any or all channels, but also for high fidelity reproduction of the LFE (low-frequency effect) channel included in Dolby Digital and DTS software. The position of the subwoofer is not so critical, because low bass sounds are not highly directional. But it is better to place the subwoofer near the front speakers. Turn it slightly toward the center of the room to reduce wall reflections.

Presence speakers (PR and PL)

Presence speakers supplement the sound from the front speakers with extra ambient effects produced by CINEMA DSP (see page 46). These effects include sounds that filmmakers intend to locate a little farther back behind the screen in order to create more theater-like ambience. Place these speakers at the front of the room about 0.5 - 1 m (1 - 3 ft) outside the front speakers, facing slightly inwards, and about 1.8 m (6 ft) above the floor.

Note

Surround back and presence speakers do not output sound simultaneously. You can set to prioritize either set of speakers in SOUND MENU (see page 60).

■ Di-pole speaker layout

Either di-pole or direct radiating speaker types can be used for THX surround. If you choose di-pole speakers, please place the surround and surround back speakers according to the speaker layout below.

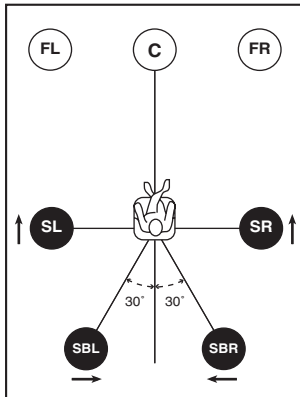

● : Di-pole speaker

↑ : Direction of di-pole speaker

Speaker connections

Be sure to connect the left channel (L), right channel (R), “+” (red) and “-” (black) properly. If the connections are faulty, no sound will be heard from the speakers, and if the polarity of the speaker connections is incorrect, the sound will be unnatural and lack bass.

CAUTION

- If you will use 6 ohm speakers, be sure to set this unit's speaker impedance setting to 6 ohms before using (see page 25).
- Before connecting the speakers, make sure that the power of this unit is off.
- Do not let the bare speaker wires touch each other or do not let them touch any metal part of this unit. This could damage this unit and/or speakers.
- Use magnetically shielded speakers. If this type of speakers still creates the interference with the monitor, place the speakers away from the monitor.

A speaker cord is actually a pair of insulated cables running side by side. One cable is colored or shaped differently, perhaps with a stripe, groove or ridges. Connect the striped (grooved, etc.) cable to the “+” (red) terminals on this unit and your speaker. Connect the plain cable to the “-” (black) terminals.

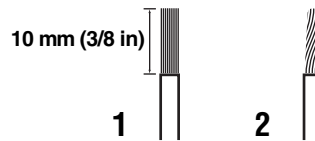

1 Remove approximately 10 mm (3/8 in) of insulation from each of the speaker cables.

2 Twist the exposed wires of the cable together to prevent short circuits.

3 Loosen the knob.

The supplied speaker terminal wrench is useful for loosening or tightening knobs.

4 Insert one bare wire into the hole in the side of each terminal.

- 5 Tighten the knob to secure the wire.

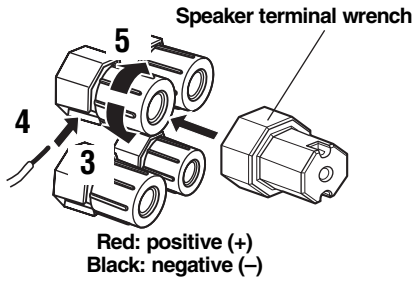

- Connecting to PRESENCE/ZONE 2 or PRESENCE speaker terminals

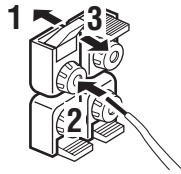

- 1 Open the tab.
- 2 Insert one bare wire into the hole of each terminal.
- 3 Return the tab to secure the wire.

■ Banana plug connections

First, tighten the knob and then insert the banana plug connector into the end of the corresponding terminal.

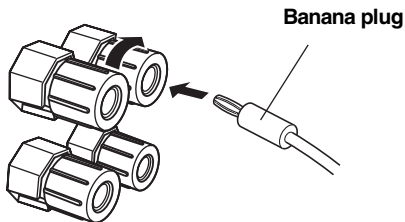

You can also use banana plugs with the PRESENCE/ZONE 2 and PRESENCE speaker terminals. Open the tab, then insert one banana plug connector into the hole of each terminal. Do not attempt to close the tabs after connecting the banana plugs.

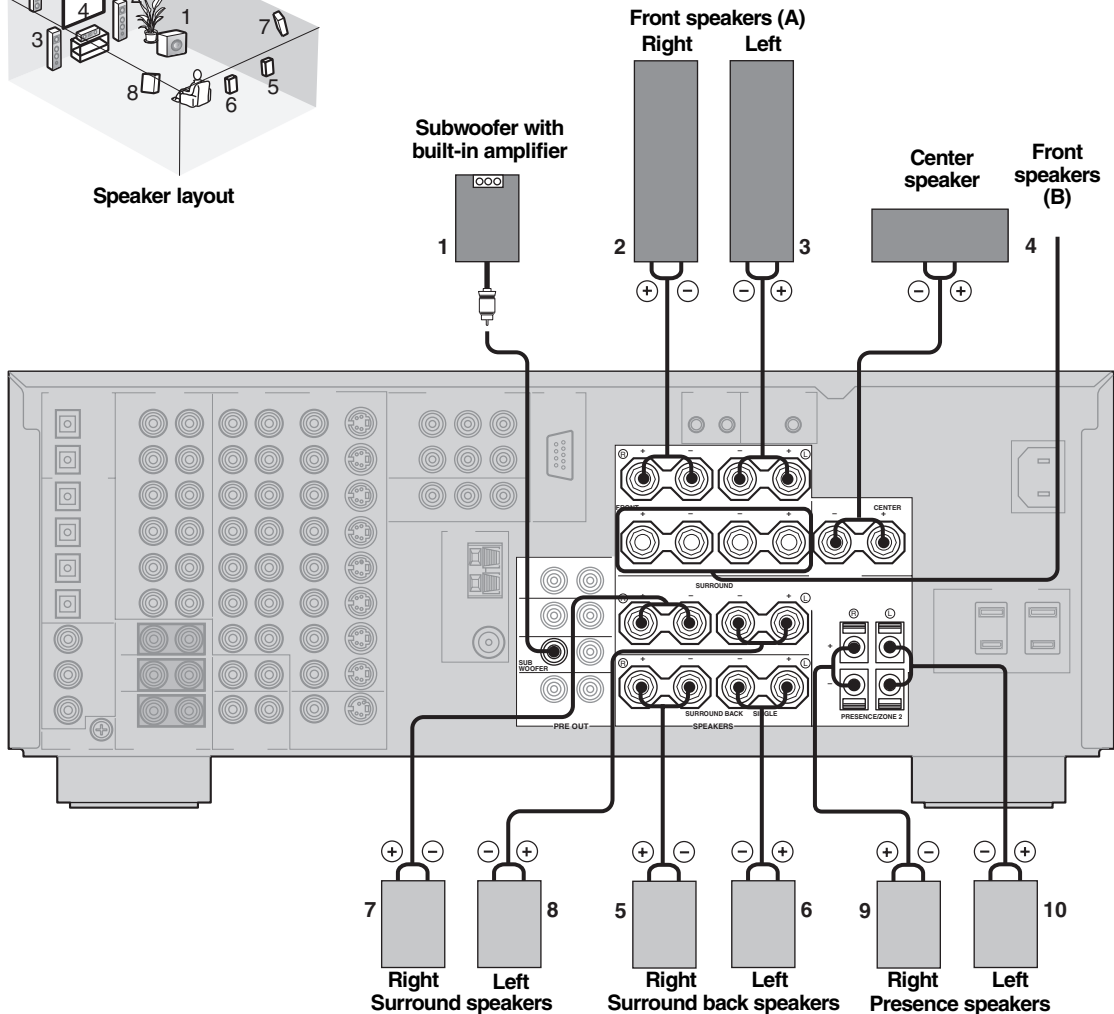
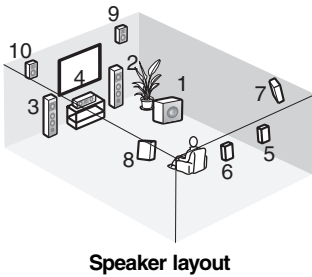

- You can connect both surround back and presence speakers to this unit, but they do not output sound simultaneously. You can set to prioritize either set of speakers in SOUND MENU (see page 60).
- The surround back speakers output the surround back channel included in Dolby Digital EX and DTS-ES software and only operate when the Dolby Digital EX, DTS-ES or Dolby Pro Logic IIx decoder is turned on.
- The presence speakers output ambient effects created by the DSP sound fields. They do not output sound when other sound fields are selected.

■ **FRONT terminals**

Connect one or two speaker systems to these terminals. If you use only one speaker system, connect it to either the FRONT A or B terminals.

Note

The Canada model cannot output to two separate speaker systems simultaneously.

■ **Bi-wired connection**

The unit also allows you to make bi-wired connections to one speaker system. Use two pairs of speaker cables for each speaker (one pair for the woofer and one pair for the tweeter/mid-range). To use the bi-wired connections, press SPEAKERS A and SPEAKERS B on the front panel so that both SP A and B light up in the front panel display.

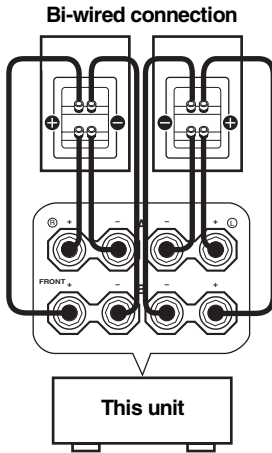

■ **CENTER terminals**

Connect a center speaker to these terminals.

■ **SURROUND terminals**

Connect surround speakers to these terminals.

■ **SUBWOOFER jack**

Connect a subwoofer with a built-in amplifier, such as the YAMAHA Active Servo Processing Subwoofer System, to this jack.

■ **SURROUND BACK terminals**

Connect surround back speakers to these terminals. If you only connect one surround back speaker, connect it to the left (L) terminals.

■ **PRESENCE terminals**

Connect presence speakers to these terminals.



- You can specify the location of speakers connected to the SPEAKERS B terminals in the SP B menu of the SET MENU mode (See page 64).
- You can select how the volume control operate with regard to the ZONE 2 OUTPUT and ZONE 3 OUT PUT in the ZONE 2 SET and ZONE 3 SET menus of the SET MENU mode (See page 64).
- You can select how the ZONE 2 will be amplified in the ZONE 2 AMP menu of the SET MENU mode (See page 64).

CONNECTIONS

Before connecting components

CAUTION

Do not connect this unit or other components to the mains power until all connections between components are complete.

■ Cable indications

For analog signals

left analog cables



right analog cables



For digital signals

optical cables



coaxial cables



For video signals

video cables



S-video cables



■ Analog jacks

You can input analog signals from audio components by connecting audio pin cables to the analog jacks on this unit. Connect red plugs to the right jacks and white plugs to the left jacks.

■ Digital jacks

This unit has digital jacks for direct transmission of digital signals through either coaxial or fiber optic cables. You can use the digital jacks to input PCM, Dolby Digital and DTS bitstreams. When you connect components to both the COAXIAL and OPTICAL jacks, priority is given to the input signals from the COAXIAL jack. All digital input jacks are compatible with 96-kHz sampling digital signals.

Note

This unit handles digital and analog signals independently. Thus audio signals input to the analog jacks are only output to the analog OUT (REC) jacks. Likewise audio signals input to the digital (OPTICAL or COAXIAL) jacks are only output to the DIGITAL OUTPUT jacks.

Dust protection cap

Pull out the cap from the optical jack before you connect the fiber optic cable. Do not discard the cap. When you are not using the optical jack, be sure to put the cap back in place. This cap protects the jack from dust.

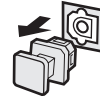

■ Video jacks

This unit has three types of video jacks. Connection depends on the availability of input jacks on your monitor. The signals input through the S VIDEO jacks on this unit are automatically converted for output through the VIDEO jacks. When V CONV. is set to "ON" (see page 63), signals input through the VIDEO jacks can be output through the S VIDEO and COMPONENT VIDEO jacks. Likewise, signals input through the S VIDEO jacks can also be output through the COMPONENT VIDEO jacks.



VIDEO jack

For conventional composite video signals.

S VIDEO jack

For S-video signals, separated into luminance (Y) and color (C) video signals to achieve high-quality color reproduction.

COMPONENT VIDEO jacks

For component signals, separated into luminance (Y) and color difference (PB, PR) to provide the best quality in picture reproduction.

Signal flow inside this unit

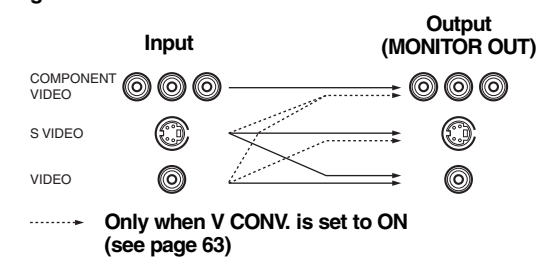

Note

When signals are input through both the S VIDEO and VIDEO jacks, signals input through the S VIDEO jack have priority.

Connecting video components

■ Connections for DVD playback

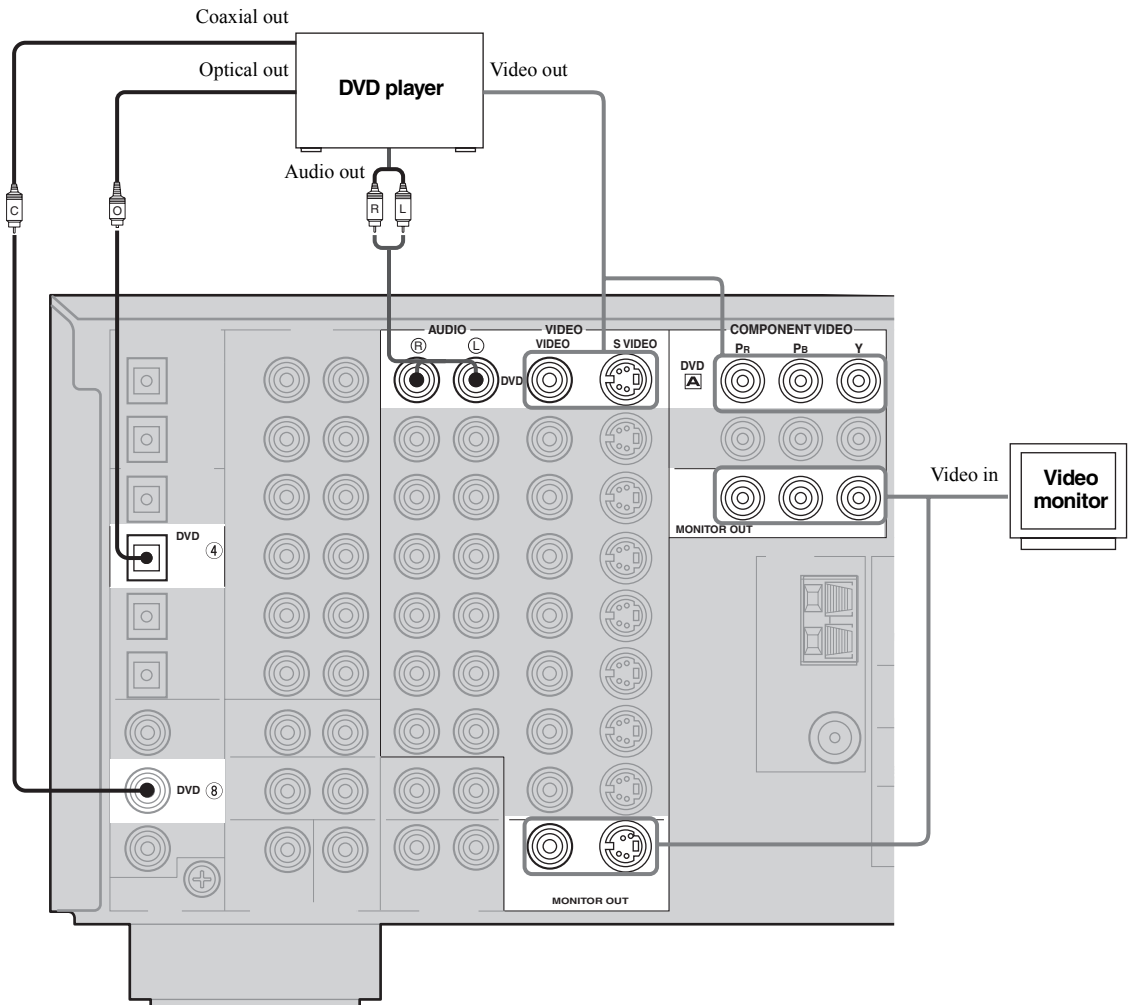

■ Connecting to the MULTI CH INPUT jacks

This unit is equipped with 6 additional input jacks (left and right FRONT, CENTER, left and right SURROUND and SUBWOOFER) for discrete multi-channel input from a multi-format player, external decoder, sound processor or pre-amplifier.

If you set MULTI CH INPUT 6ch/8ch to “8ch” (see page 62), you can use input jacks assigned as MULTI CH INPUT FRONT (page 62) together with the MULTI CH INPUT jacks to input 8 channels.

Connect the output jacks on your multi-format player or external decoder to the MULTI CH INPUT jacks. Be sure to match the left and right outputs to the left and right input jacks for the front and surround channels.

For 6-channel input

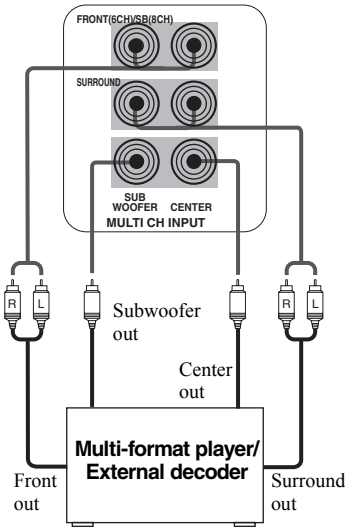

For 8-channel input

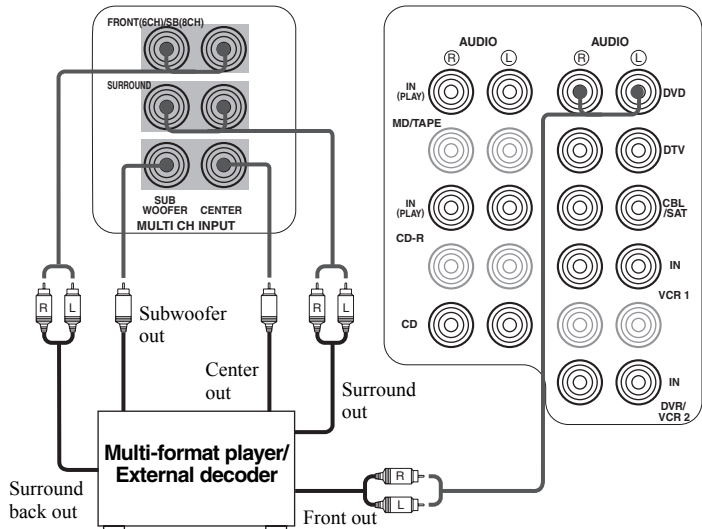

Notes

- When you select MULTI CH INPUT as the input source, this unit automatically turns off the digital sound field processor, and you cannot select sound field programs.
- This unit does not redirect signals input to the MULTI CH INPUT jacks to accommodate for missing speakers. We recommend that you connect at least a 5.1-channel speaker system before using this feature.
- When headphones are used, only front L/R channels are output.

■ Connections for other video components

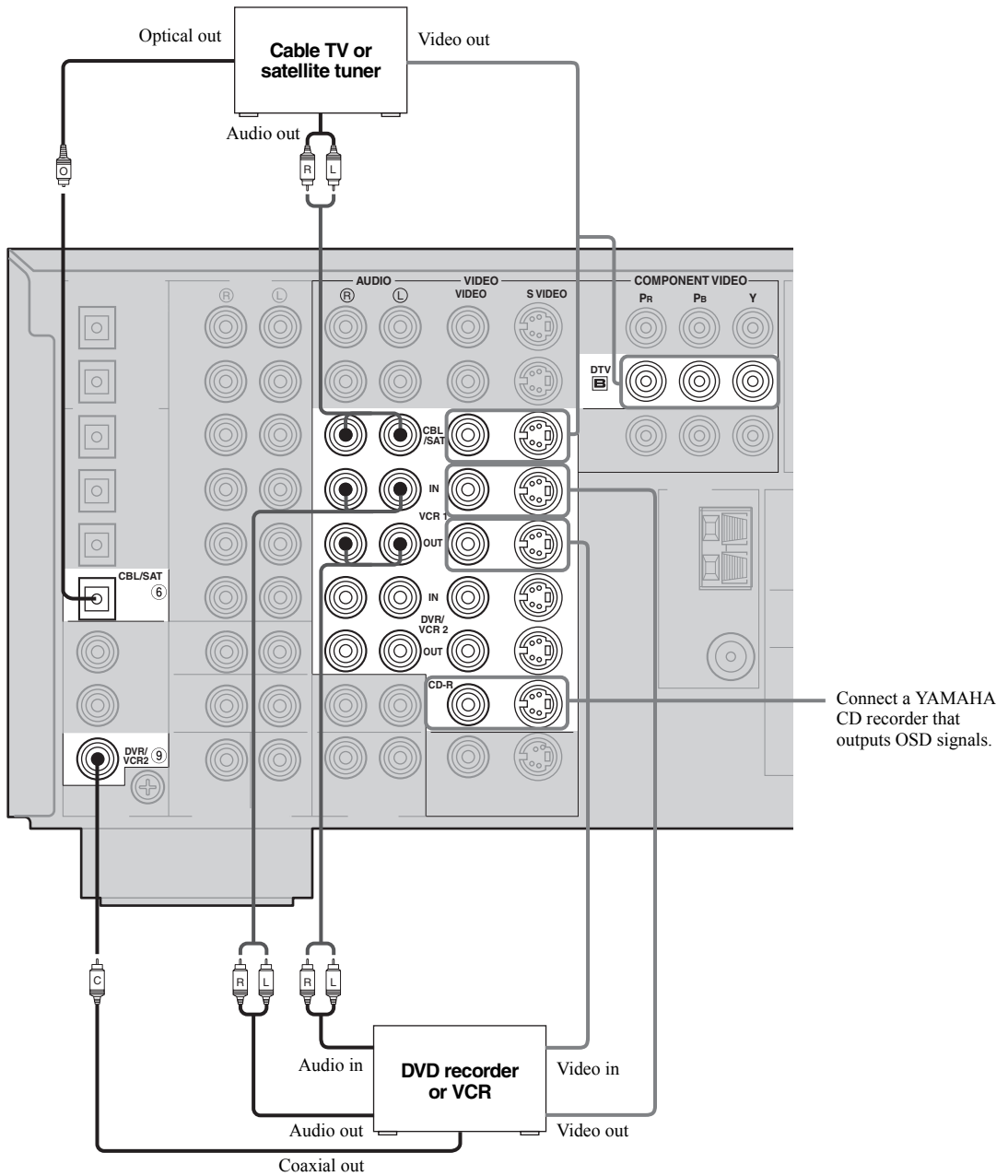

■ VIDEO AUX jacks (on the front panel)

Use these jacks to connect any video source, such as a game console or camcorder, to this unit.

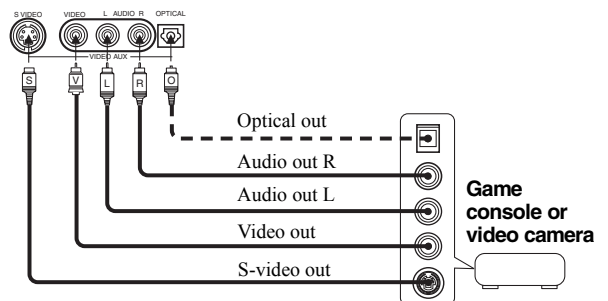

Connecting audio components

■ Connections for audio components

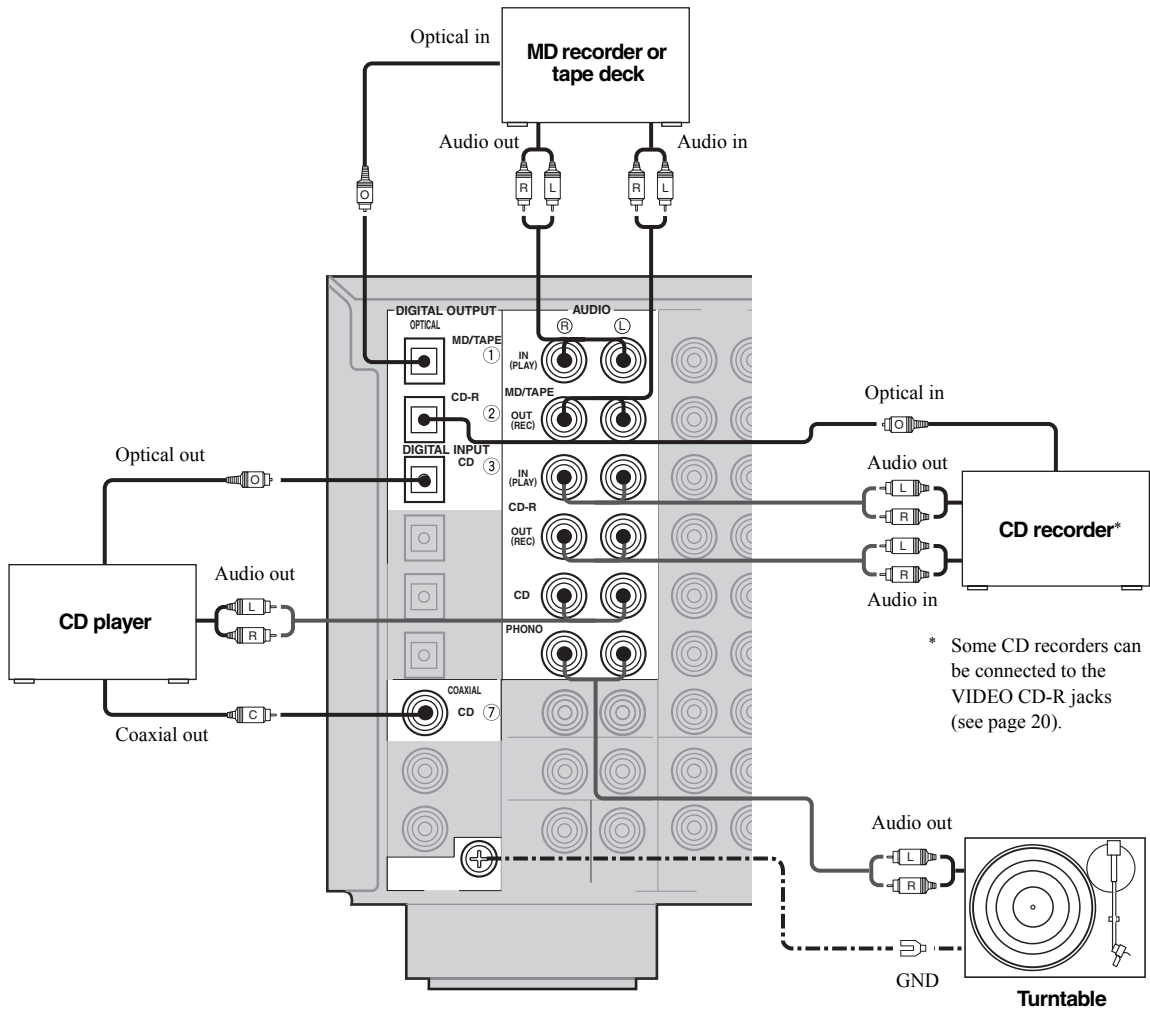

PREPARATION

■ Connecting a turntable

PHONO jacks are for connecting a turntable with an MM or high-output MC cartridge. If you have a turntable with a low-output MC cartridge, use an in-line boosting transformer or MC-head amplifier when connecting to these jacks.



Connect your turntable to the GND terminal to reduce noise in the signal. However, you may hear less noise without the connection to the GND terminal for some record players.

■ Connecting to an external amplifier

If you want to increase the power output to the speakers, or want to use another amplifier, connect an external amplifier to the PRE OUT jacks as follows.

Notes

- When audio pin plugs are connected to the PRE OUT jacks for output to an external amplifier, it is not necessary to use the corresponding SPEAKERS terminals. Set the volume of the external amplifier connected to this unit to the maximum.
- The signal output through the FRONT PRE OUT and CENTER PRE OUT jacks are affected by the TONE CONTROL settings.
- If SPEAKERS A is turned off and SP B is set to ZONE B (see page 64), signals will only be output from the FRONT PRE OUT jacks.

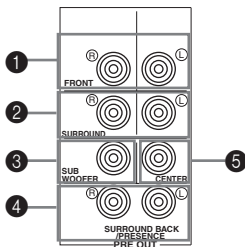

❶ FRONT PRE OUT jacks

Front channel line output jacks.

❷ SURROUND PRE OUT jacks

Surround channel line output jacks.

❸ SUBWOOFER PRE OUT jack

Connect a subwoofer with built-in amplifier, such as the YAMAHA Active Servo Processing Subwoofer System, to this jack.

❹ SURROUND BACK/PRESENCE PRE OUT jacks

Surround back or presence channel line output jacks.

❺ CENTER PRE OUT jack

Center channel line output jack.

Notes

- Each PRE OUT jack outputs the same channel signal as the corresponding speaker terminals. However, when both surround back and presence speakers are setup in this unit, the signals output from SURROUND BACK/PRESENCE PRE OUT jacks may not correspond to the correct speakers.
- Adjust the volume level of the subwoofer with the control on the subwoofer. It is also possible to adjust the volume level by using the remote control (see “Manually adjusting speaker levels” on page 51).
- Some signals may not be output from the SUBWOOFER PRE OUT jack depending on the SPEAKER SET (see page 55) and LFE/BASS OUT (see page 56) settings.

Connecting the antennas

Both AM and FM indoor antennas are included with this unit. In general, these antennas should provide sufficient signal strength. Connect each antenna correctly to the designated terminals.

AM loop antenna (included) **Indoor FM antenna (included)**

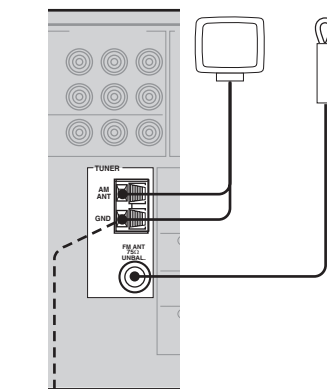

Ground (GND terminal)

For maximum safety and minimum interference, connect the antenna GND terminal to a good earth ground. A good earth ground is a metal stake driven into moist earth.

Notes

- The AM loop antenna should be placed away from this unit.
- The AM loop antenna should always be connected, even if an outdoor AM antenna is connected to this unit.
- A properly installed outdoor antenna provides clearer reception than an indoor one. If you experience poor reception quality, an outdoor antenna may improve the quality. Consult the nearest authorized YAMAHA dealer or service center about outdoor antennas.

■ Connecting the AM loop antenna

- 1 Set up the AM loop antenna, then connect it to the terminals on this unit.

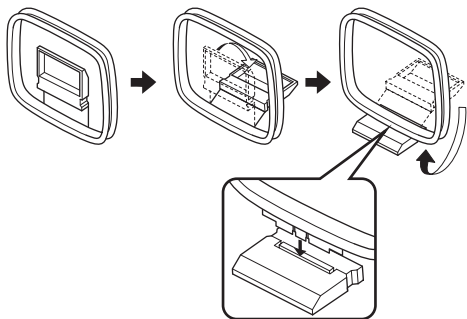

- 2 Press and hold the tab to insert the AM loop antenna lead wires into the AM ANT and GND terminals.

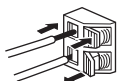

- 3 Orient the AM loop antenna for the best reception.



Connecting the power supply cord

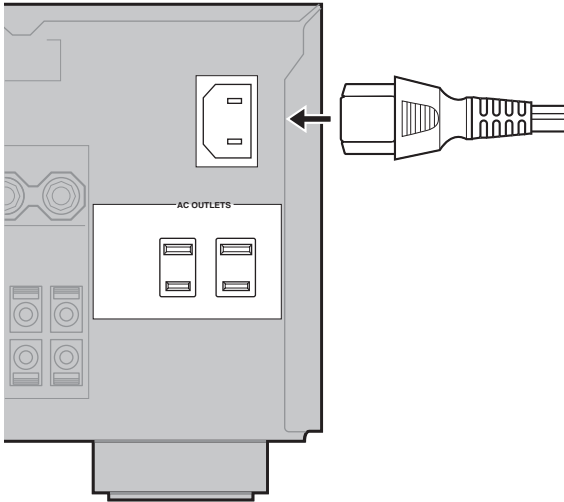

■ Connecting the AC power cord

Plug the power cord into the AC inlet after all other connections are complete, then plug the power cord to an AC wall outlet.

CAUTION

Do not use other AC power cords. Use the one provided. Use of other power cords may result in fire hazard or electrical shock.

■ AC OUTLET(S) (SWITCHED)

Use outlets to connect the power cords from your other components to this unit. Power to the AC OUTLET is controlled by this unit's STANDBY/ON (or SYSTEM POWER and STANDBY). These outlets will supply power to any connected component whenever this unit is turned on. The maximum power (total power consumption of components) that can be connected to the AC OUTLET is 100 W.

■ Memory back-up

The memory back-up circuit prevents the stored data from being lost even if this unit is in the standby mode. However if the power cord is disconnected from the AC wall outlet, or the power supply is cut for more than one week, the stored data will be lost.

Speaker impedance setting

CAUTION

If you are using 6 ohm speakers, set the impedance to 6 ohms as follows before turning on the power.

Be sure this unit is in the standby mode.

- 1 On the front panel, while holding down SPEAKERS A, press STANDBY/ON.**
 "SP IMP.SET" appears in the front panel display for a few seconds, then "Minimum 8ohms" appears.

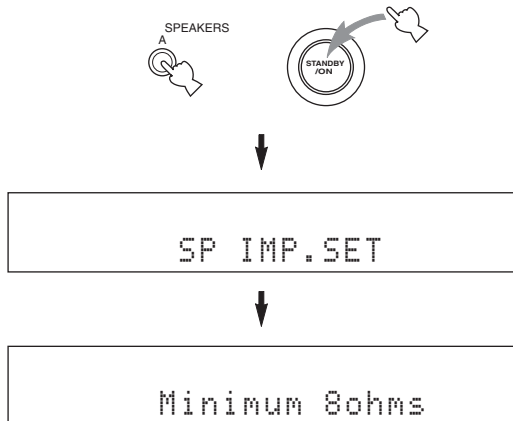

- 2 Press SPEAKERS A or SPEAKERS B to select the impedance of your speakers.**
 You can select either 6 ohms or 8 ohms.

- 3 Press STANDBY/ON to exit the setting.**
 This unit will be set to the standby mode.

 You can also use SP IMP.SET (see page 63) to set the speaker impedance.

Turning on the power

When all connections are complete, turn on the power of this unit.

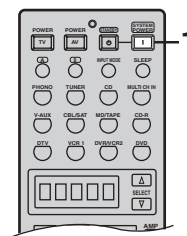
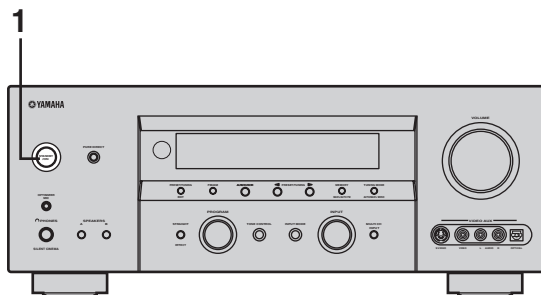

- 1 Press STANDBY/ON (SYSTEM POWER on the remote control) to turn on the power of this unit.**

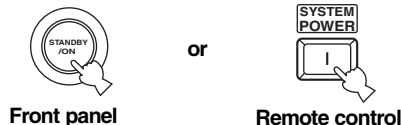

- 2 Turn on the video monitor connected to this unit.**

Note

Press STANDBY/ON again (STANDBY on the remote control) to enter the standby mode.

AUTO SETUP

Introduction

This receiver employs YAMAHA Parametric Room Acoustic Optimizer (YPAO) technology which lets you avoid troublesome listening-based speaker setup and achieves highly accurate sound adjustments. The supplied optimizer microphone collects and analyzes the sound your speakers produce in your actual listening environment.



The basic setup feature (page 31) is useful if you want to set up your system quickly and with minimal effort. However, we recommend that you come back and perform auto setup later to take advantage of YPAO and enjoy even higher fidelity.

Notes

- Please be advised that it is normal for loud test tones to be output during the auto setup procedure.
- If auto setup stops and error messages appear on the screen, follow the troubleshooting on page 29.

YPAO performs the following checks and makes appropriate adjustments to give you the best possible sound from your system.

WIRING

Checks which speakers are connected and the polarity of each speaker.

DISTANCE

Checks the distance of each speaker from the listening position and adjusts the timing of each channel.

SIZE

Checks the speaker's frequency response and sets the appropriate low frequency crossover for each channel.

EQUALIZING

Adjusts frequency and levels of each channel's parametric equalizer to reduce coloration across the channels and create a cohesive sound field. This is particularly important if you use different brands or sizes of speakers for some channels or have a room with unique sonic characteristics.

YPAO equalizing calibration incorporates three parameters (frequency, level and Q factor) for each of the seven bands in its parametric equalizer to provide highly precise automatic adjustment of frequency characteristics.

LEVEL

Checks and adjusts the sound level (volume) of each speaker.

Optimizer microphone setup

- 1 Connect the supplied optimizer microphone to the OPTIMIZER MIC jack on the front panel.**

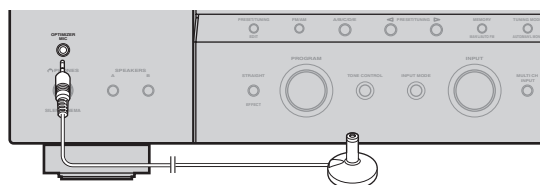

Notes

- After you have completed the auto setup procedure, be sure to disconnect the optimizer microphone.
- The optimizer microphone is sensitive to heat.
 - Keep it away from direct sunlight.
 - Do not place it on top of this unit.

- 2 Place the optimizer microphone on a flat level surface with the omni-directional microphone head upward, at your normal listening position.**

If possible, use a tripod (etc.) to affix the optimizer mic at the same height as your ears would be when you are seated in your listening position.

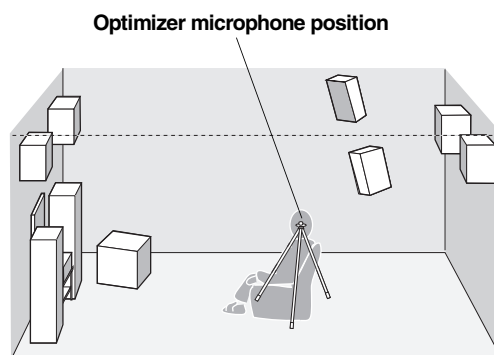

Starting the setup

For best results, make sure the room is as quiet as possible during the auto setup procedure (YPAO). If there is too much ambient noise, the results may not be satisfactory.



If your subwoofer can adjust the output volume and the crossover frequency, set the volume to about half way (or slightly less) and set the crossover frequency to the maximum.

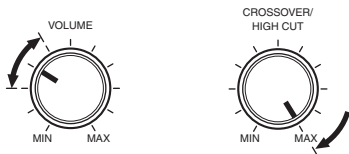

Subwoofer

1 Switch on this unit and video monitor.

Make sure the OSD is displayed (see page 50).

2 Set AMP/SOURCE/TV to AMP, then press SET MENU to enter the SET MENU.



3 Press Δ / ∇ to select AUTO SETUP, then press \triangleright once to enter the main menu.

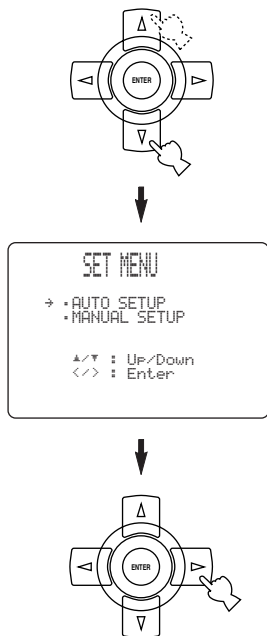

4 Press Δ / ∇ repeatedly to select WIRING, DISTANCE, SIZE, EQUALIZING or LEVEL.

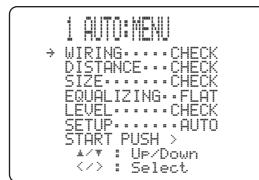

5 When WIRING, DISTANCE, SIZE or LEVEL is selected, press \triangleleft / \triangleright to select:

- CHECK To automatically check and adjust the selected item.
- SKIP To skip the selected item and perform no adjustments.

Note

When using THX speakers, set SIZE to SKIP and make sure that "SMALL" or "SMLx2" is selected in SPEAKER SET (page 55) and that 80Hz (THX) is selected in CROSS OVER (page 57).

When EQUALIZING is selected, press \triangleleft / \triangleright to select:

- FRONT To adjust the frequency response of each speaker in accordance with the sound of your front speakers. Recommended if your front speakers are of much higher quality than your other speakers.
- FLAT To average the frequency response of all speakers. Recommended if all of your speakers are of similar quality.
- LOW To average the frequency response of all speakers, giving priority to the accuracy of bass frequencies.
- MID To average the frequency response of all speakers, giving priority to the accuracy of mid-range frequencies.
- HIGH To average the frequency response of all speakers, giving priority to the accuracy of high frequencies.
- SKIP To skip the selected item and perform no adjustments.

6 Press ∇ to select SETUP, then press \triangleleft / \triangleright to select:

- AUTO To automatically perform the entire auto setup procedure.
- STEP To pause for confirmation between each check in the auto setup procedure.
- RELOAD To restore the last auto setup setting.

7 Press ∇ to select START PUSH \triangleright , then press \triangleright .

Low test tones will be output from each speaker and WAIT appears during the auto setup procedure.

Note

If “E-10:OTHER ERROR” appears during testing, restart the procedure from step 3.

If you selected “AUTO” in step 6

The RESULT display appears for a few seconds after each check, then settings of the next item will start. The RESULT:EXIT display appears after all items are set.



You can display each result by pressing Δ once and pressing \triangleright repeatedly before exiting. Pressing ∇ returns to the RESULT:EXIT display.

8 To apply the changes, press $\triangleleft/\triangleright$ to select SET, then press ∇ to exit.

To cancel the auto setup procedure, press $\triangleleft/\triangleright$ to select CANCEL, then press ∇ to exit.

If you selected “STEP” in step 6

The RESULT display appears after each check.

8 Press $\triangleleft/\triangleright$ to display RESULT:EXIT, then press $\triangleleft/\triangleright$ to select:

- NEXT Then press ∇ to proceed and check the next item.
- EXIT Then press ∇ to exit the auto setup.

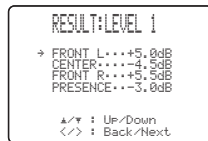
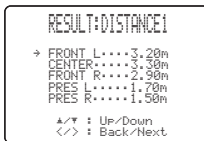
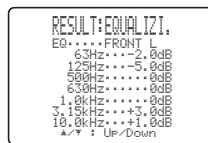
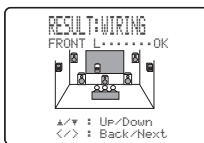

- Press Δ/∇ repeatedly to move between each display.
- If you are not satisfied with the result or want to manually adjust each setup parameter, use the manual setup parameters (see page 55).

Notes

- If you change speakers, speaker positions, or the layout of your listening environment, perform AUTO SETUP again to recalibrate your system.
- In the DISTANCE results, the distance displayed may be longer than the actual distance depending on the characteristics of your subwoofer.
- In the EQUALIZING results, different values may be set for the same band to provide finer adjustments.

If you selected “RELOAD” in step 6

The RESULT:EXIT display appears.



You can display each result by pressing Δ once and pressing \triangleright repeatedly before exiting. Pressing ∇ returns to the RESULT:EXIT display.

8 Press $\triangleleft/\triangleright$ to select “SET”, then press ∇ to exit.

■ Troubleshooting for auto setup procedure

Before auto setup

Error message	Cause	Remedy
Connect MIC!	Optimizer microphone is not connected.	<ul style="list-style-type: none"> Connect the supplied optimizer microphone to the OPTIMIZER MIC jack on the front panel.
Unplug HP!	Headphones are connected.	<ul style="list-style-type: none"> Unplug the headphones.

During auto setup

Press </> to display the detailed information about individual errors. Select “RETRY” to try auto setup procedure again.

Error message	Cause	Remedy
E-1:NO FRONT SP	Front L/R channel signal(s) is (are) not detected.	<ul style="list-style-type: none"> Select the front speakers with SPEAKER A or B. Check the front L/R speaker connections.
E-2:NO SURR.SP	A surround channel signal is not detected.	<ul style="list-style-type: none"> Check the surround speaker connections.
E-3:NO PRES. SP	A presence channel signal is not detected.	<ul style="list-style-type: none"> Check the presence speaker connections.
E-4:SBR->SBL	Only right surround back channel signal is detected.	<ul style="list-style-type: none"> Connect the surround back speaker to the LEFT SURROUND BACK SPEAKERS terminal if you only have one surround back speaker.
E-5:NOISY	Background noise is too loud.	<ul style="list-style-type: none"> Try auto setup procedure in a quiet environment. Turn off noisy electric equipment like air conditioners (etc.) or move them away from the optimizer microphone.
E-6:CHECK SURR.	Surround back speaker(s) is (are) connected, though surround L/R speakers are not.	<ul style="list-style-type: none"> Connect surround speakers when you use (a) surround back speaker(s).
E-7:NO MIC	The optimizer microphone was unplugged during the auto setup procedure.	<ul style="list-style-type: none"> Connect the supplied optimizer microphone to OPTIMIZER MIC jack on the front panel.
E-8:NO SIGNAL	The optimizer microphone does not detect test tones.	<ul style="list-style-type: none"> Check the microphone setting. Check the speaker connections and placement.
E-9:USER CANCEL	The auto setup procedure was cancelled due to user activity.	<ul style="list-style-type: none"> Perform the auto setup procedure again.
E-10:OTHER ERROR	An internal error occurred.	<ul style="list-style-type: none"> Perform the auto setup procedure again.

After auto setup

Press </> to display the detailed information about individual warnings.

Warning message	Cause	Remedy
W-1: OUT OF PHASE	Speaker polarity is not correct. This message may appear depending on the speakers even when the speakers are connected correctly.	<ul style="list-style-type: none"> • Check the speaker connections for proper polarity (+ or -).
W-2: OVER 24m (80ft.)	The distance between the speaker and the listening position is over 24 m (80 ft).	<ul style="list-style-type: none"> • Bring the speaker closer to the listening position.
W-3: LEVEL ERROR	The difference of volume level among speakers is excessive. (No level correction is made.)	<ul style="list-style-type: none"> • Readjust the speaker installation so that all speakers are set in locations with similar conditions. • Check the speaker connections. • Use speakers of similar quality. • Adjust the output volume of the subwoofer.
W-4: SWFR PHASE	The phase polarity of the subwoofer is not correct.	<ul style="list-style-type: none"> • Select the opposite phase on the subwoofer if the subwoofer has a phase switch.
W-5: VOL ERROR	The result may not be correct because the volume was changed during the auto setup procedure.	<ul style="list-style-type: none"> • Perform the auto setup procedure again. Do not change the volume during the auto setup procedure.

- If the ERROR or WARNING screens appears, check the cause of the problem, then perform the auto setup procedure again.
- If warning W-1, W-4 or W-5 appears, corrections are made, but they may not be optimal.
- If warning W-2 or W-3 appears, no corrections are made.
- If error E-10 occurs repeatedly, please contact a qualified YAMAHA service center.

BASIC SETUP

The basic system parameters are set automatically when you run auto setup (page 26). Basic setup is useful if you want to quickly setup your speakers or to manually adjust some of the items set in auto setup.



If you wish to configure the unit manually using more precise adjustments, use the detailed parameters in SOUND MENU (page 55) instead of BASIC MENU.

Note

Altering any parameters in BASIC MENU will reset all parameters in SOUND MENU.

Using BASIC MENU

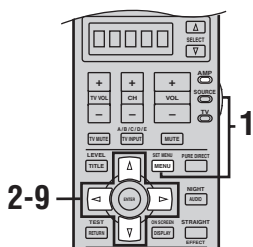

- 1 Set AMP/SOURCE/TV to AMP, then press SET MENU to enter the SET MENU.



- 2 Press Δ / ∇ repeatedly to select MANUAL SETUP, then press \triangleleft / \triangleright to enter the selected category.

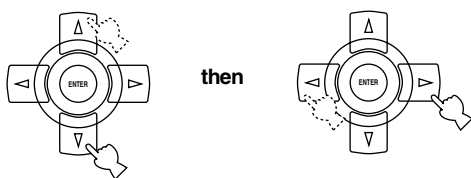

If Δ is pressed when AUTO SETUP is selected, or if ∇ is pressed when MANUAL SETUP is selected, SET MENU will be closed. Press SET MENU to open SET MENU again.

- 3 Press \triangleleft / \triangleright to enter BASIC MENU.

- 4 When ROOM is selected, press \triangleleft / \triangleright to change the setting.

Select the size of the room you have installed your speakers in. Roughly speaking, the room sizes are defined as follows:

S (small)	16 x 13 ft, 200 ft ² (4.8 x 4.0 m, 20 m ²)
M (medium)	20 x 16 ft, 300 ft ² (6.3 x 5.0 m, 30 m ²)
L (large)	26 x 19 ft, 450 ft ² (7.9 x 5.8 m, 45 m ²)



- 5 Press ∇ to select SWFR, then press \triangleleft / \triangleright to select:

YES If you have a subwoofer in your system.
 NONE If you do not have a subwoofer in your system.

- 6 Press ∇ to select PRESENCE, then press \triangleleft / \triangleright to select:

YES If you have presence speakers in your system.
 NONE If you do not have presence speakers in your system.

7 Press ▾ to select SPEAKERS, then press </> to select the number of speakers connected to the unit.

The choices vary as follows depending on the PRESENCE setting:

Choices	PRESENCE setting			
	YES		NONE	
2	—	—	L R	Front L/R
3	—	—	L C R	Front L/R, Center
4	L R	Presence L/R, Front L/R	L R SL SR	Front L/R, Surround L/R
5	L C R	Presence L/R, Front L/R, Center	L C R SL SR	Front L/R, Center, Surround L/R
6	L R SL SR	Presence L/R, Front L/R, Surround L/R	L C R SL SB SR	Front L/R, Center, Surround L/R, Surround back
7	L C R SL SR	Presence L/R, Front L/R, Center, Surround L/R	L C R SL SB SR	Front L/R, Center, Surround L/R, Surround back L/R
8	L C R SL SB SR	Presence L/R, Front L/R, Center, Surround L/R, Surround back*	—	—
9	L C R SL SB SR	Presence L/R, Front L/R, Center, Surround L/R, Surround back L/R*	—	—

* Surround back and presence speakers do not output sound simultaneously. You can set to prioritize either set of speakers in SOUND MENU (see page 60).

8 After you have finished the settings, press ▾, then press </> to select:

- SET To apply the changes.
- CANCEL To cancel the setup.



If you select "SET", you will hear a test tone from each speaker.

9 Press ▾ to select CHECK OK?, then press </> to select:

- YES To exit the setup if the test tones were satisfactory.
- NO To adjust each speaker level (see page 57).



↓ (when "NO" is selected)



Memory back-up

The memory back-up circuit prevents the stored data from being lost even if this unit is in the standby mode. However, if the power cord is disconnected from the AC outlet, or the power supply is cut for more than one week, the stored data will be lost. If so, adjust the items again.

PLAYBACK

Basic operations

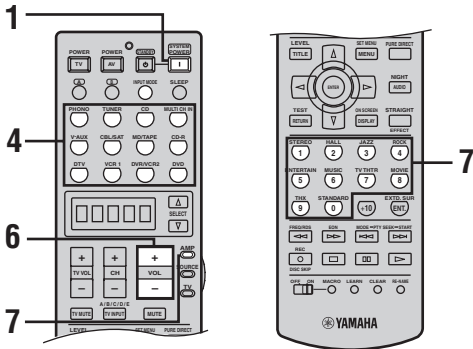
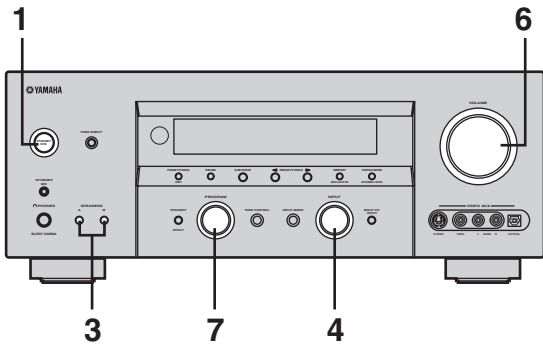

- 1 Press **STANDBY/ON** (**SYSTEM POWER** on the remote control) to turn on the power.

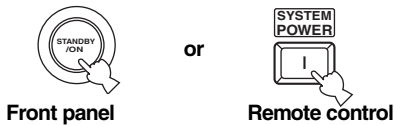

- 2 Turn on the video monitor connected to this unit.

- 3 Press **SPEAKERS A** or **B** on the front panel. Each press turns the respective speakers on or off.

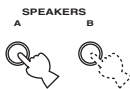

When bi-wiring, select both A and B.

- 4 Select the input source.

Use **INPUT** (or press one of the input selector buttons on the remote control) to select the input you desire.

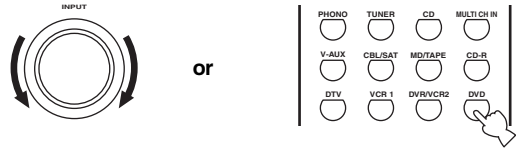

Front panel

Remote control

The current input source name and input mode appear in the front panel display and video monitor for a few seconds.



Selected input source

Input mode

- 5 Start playback or select a broadcast station on the source component.

Refer to the operation instructions for the component.

- 6 Adjust the volume to the desired output level.

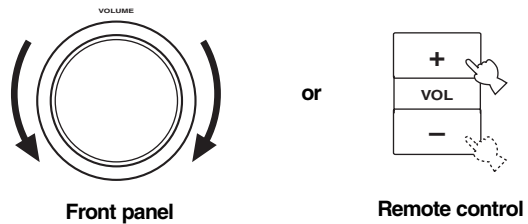

7 Select a sound field program if desired.

Use PROGRAM (or set AMP/SOURCE/TV to AMP, then press one of the sound field program buttons repeatedly) to select a sound field program. See page 46 for details about sound field programs.

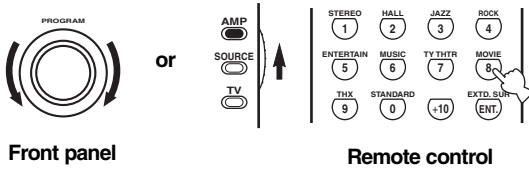

Front panel

Remote control

Note

When this unit detects Dolby Digital signals, the following display appears for a few seconds. This shows how the signal level is being corrected to become -27 dB (THX recommendation).

DialNorm = +4dB

Selecting sound field programs

Front panel operation

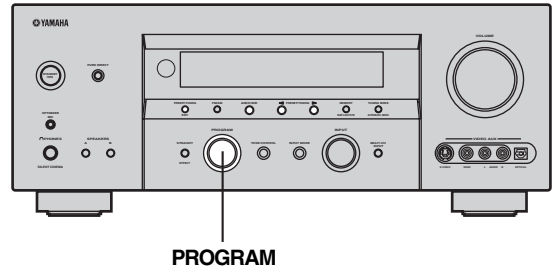

Rotate PROGRAM to select the desired program.

The name of the selected program appears in the front panel display and video monitor.

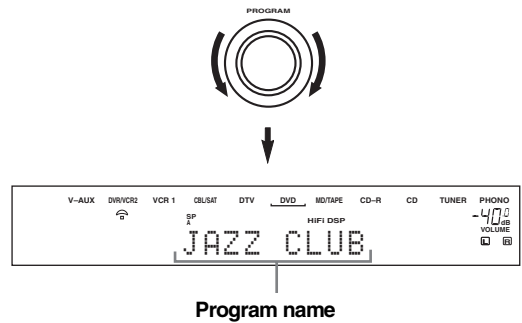

Program name

Remote control operation

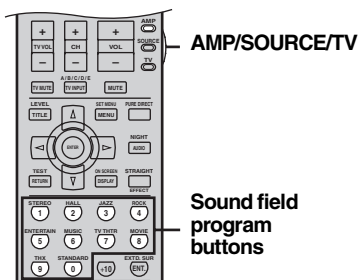

Set AMP/SOURCE/TV to AMP, then press one of the sound field program buttons repeatedly to select the desired program.

The name of the selected program appears in the front panel display and video monitor.

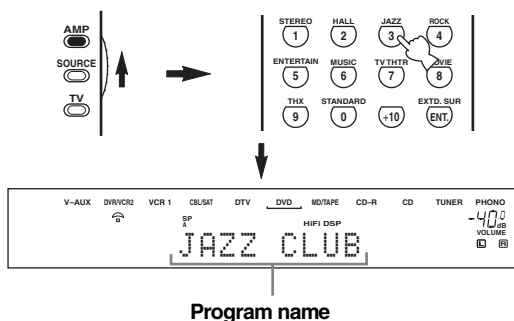

Program name



Choose a sound field program based on your listening preference, and not on the name of the program.

Notes

- When you select an input source, this unit automatically selects the last sound field program used with that source.
- Sound field programs cannot be selected when the MULTI CH INPUT is selected.

Additional operations

To adjust the tone

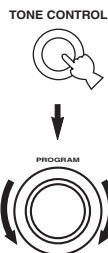

You can adjust the bass/treble balance for the front left/right and center channels.

Press TONE CONTROL repeatedly on the front panel to select TREBLE or BASS.

Select TREBLE, then rotate PROGRAM to the right or left to increase or decrease the high-frequency response.

Select BASS, then rotate PROGRAM to the right or left to increase or decrease the low-frequency response.

To cancel the tone control, press TONE CONTROL repeatedly to select BYPASS.

Notes

- If you increase or decrease the high-frequency or the low-frequency sound to an extreme level, the tonal quality of the surround speakers may not match that of the front left/right and center speakers.
- TONE CONTROL is not effective when THX (page 46) or PURE DIRECT (page 37) is selected, or when MULTI CH INPUT is selected.
- TONE CONTROL is not effective for headphones. Use HP TONE CTRL to adjust bass/treble balance for the headphones (page 59).

To mute the sound

Press MUTE on the remote control. The MUTE indicator flashes in the front panel display.



To resume the audio output, press MUTE again. (or press VOL -/+). The MUTE indicator disappears from the display.



You can adjust the muting level (see page 59).

To listen with headphones (“SILENT CINEMA”)

“SILENT CINEMA” allows you to enjoy multi-channel music or movie sound, including Dolby Digital and DTS surround, through ordinary headphones. “SILENT CINEMA” activates automatically whenever you connect headphones to the PHONES jack while listening to CINEMA DSP or HiFi DSP sound field programs. When activated, the “SILENT CINEMA” indicator lights up in the front panel display.

Notes

- This unit will not be set to “SILENT CINEMA” when MULTI CH INPUT is selected as the input source.
- “SILENT CINEMA” is not effective when PURE DIRECT or a 2ch stereo program is selected, or in STRAIGHT mode.

■ Selecting the MULTI CH INPUT

Press MULTI CH INPUT so that “MULTI CH INPUT” appears in the front panel display and video monitor.

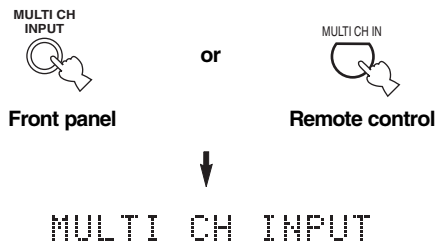

Note

When “MULTI CH INPUT” is shown in the front panel display and/or the video monitor, no other source can be played. To select another input source with INPUT (one of the input selector buttons), press MULTI CH INPUT to turn off “MULTI CH INPUT” from the front panel display and the video monitor.

■ Enjoying multi-channel software in 6.1/7.1 channel surround

If you connected one or two surround back speakers, use this feature to enjoy 6.1/7.1-channel playback for multi-channel sources using the Dolby Pro Logic IIx, Dolby Digital EX or DTS-ES decoders.

Set AMP/SOURCE/TV to AMP, then press **EXTD. SUR** on the remote control to switch between 5.1 and 6.1/7.1 channel playback.



To select a decoder, press ◀/▶ repeatedly when **PLIIxMovie (etc.)** is displayed.

AUTO (AUTO)

When a signal (flag) that can be recognized by the unit is input, the unit selects the optimum decoder for playing back the signal in 6.1/7.1 channels.

If the unit cannot recognize the flag or no flag is present in the input signal, it cannot automatically be played in 6.1/7.1 channels.

Decoders (select with ◀/▶)

You can select from the following modes depending on the format of the software you are playing.

PLIIxMovie

For playing back Dolby Digital or DTS signals in 7.1 channels using the Pro Logic IIx movie decoder.

PLIIxMusic

For playing back Dolby Digital or DTS signals in 6.1/7.1 channels using the Pro Logic IIx music decoder.

EX/ES

For playing back Dolby Digital signals in 6.1/7.1 channels using the Dolby Digital EX decoder.

DTS signals are played back in 6.1/7.1 channels using the DTS-ES decoder.

EX

For playing back Dolby Digital or DTS signals in 6.1/7.1 channels using the Dolby Digital EX decoder.

OFF (OFF)

For playing back Dolby Digital or DTS signals in 5.1 channels.



When SURR B L/R SP is set to “LRGx1” or “SMLx1” (see page 56), the surround back channel will output from the left SURROUND BACK speaker terminals.

Notes

- Some 6.1-channel compatible discs do not have a signal (flag) which this unit can automatically detect. When playing these kinds of discs with 6.1-channel, select decoders (PLIIxMovie, PLIIx Music, EX/ES or EX) manually.
- 6.1-channel playback is not possible even if EXTD. SUR is pressed in the following cases:
 - When SURR L/R SP or SURR B L/R SP is set to “NONE” (see page 56).
 - When the source connected to the MULTI CH INPUT jack is being played.
 - When the source being played does not contain surround L/R channel signals.
 - When a Dolby Digital KARAOKE source is being played.
 - When 2ch Stereo or PURE DIRECT is selected.
- When the power of this unit is turned off, the input mode will be reset to AUTO.
- When the DTS-ES decoder is applied to DTS 96/24 signals, this unit decodes the DTS 96/24 signals using DTS-ES Matrix decoder.
- The Pro Logic IIx decoder is not available when SURR B L/R SP is set to “NONE” (see page 56).
- “PLIIxMovie” cannot be selected when SURR B L/R SP is set to “LRGx1” or “SMLx1” (see page 56).

■ Enjoying 2-channel software in surround

Signals input from 2-channel sources can also be played back on multiple channels.

Press STANDARD on the remote control to select the decoder.



You can select from the following modes depending on the type of software you are playing and your personal preference.

PRO LOGIC SUR. STANDARD

Standard processing for Dolby Surround sources.

PRO LOGIC SUR. ENHANCED

CINEMA DSP enhanced processing for Dolby Surround sources

PRO LOGIC IIx Movie*

Dolby Pro Logic II/IIx processing for movie software.

PRO LOGIC IIx Music*

Dolby Pro Logic II/IIx processing for music software.

PRO LOGIC IIx Game*

Dolby Pro Logic II/IIx processing for game software.

DTS Neo:6 Cinema

DTS processing for movie software.

DTS Neo:6 Music

DTS processing for music software.

* Use the PLII/PLIIX parameter to select the Pro Logic II or Pro Logic IIx decoders (see page 85).

Note

The Pro Logic IIx decoder is not available when SURR B L/R SP is set to "NONE" (see page 56).

■ Listening to high fidelity stereo sound with PURE DIRECT

PURE DIRECT bypasses this unit's decoders and DSP processors as well as shuts down the video circuitry, allowing you to enjoy the highest possible sound fidelity from analog and PCM sources.

Press PURE DIRECT to activate pure direct.

The button lights up and the front panel display automatically goes out.

PURE DIRECT



Front panel

or

PURE DIRECT



Remote control



The front panel display switches on momentarily when an operation is performed.

To cancel, press PURE DIRECT again.

The indicator around the front panel button goes out and the previous settings are restored.

Notes

- To avoid unexpected noise, do not play DTS-encoded CDs in this mode.
- When a multi-channel signal (Dolby Digital or DTS) is input, this unit automatically switches to the corresponding analog input. (When DTS is selected as an input mode, no sound will be heard.)
- No sound will be output from the subwoofer.
- TONE CONTROL (page 35) and SET MENU (page 53) settings are not effective.
- The following operations are not possible during PURE DIRECT operation:
 - switching the sound field program
 - displaying the OSD
 - adjusting SET MENU parameters
 - all video functions (video conversion etc.)
- PURE DIRECT is automatically cancelled whenever this unit is set to the standby mode.

■ Listening to high fidelity stereo sound with Direct Stereo

Direct Stereo bypasses this unit's decoders and DSP processors, allowing you to enjoy high fidelity sound from 2-channel PCM and analog sources.



This operation is recommended for use when high fidelity stereo sound is desired with playback of a video source. Otherwise, PURE DIRECT is recommended for the highest possible sound fidelity (see page 37).

Rotate PROGRAM (or press STEREO repeatedly) to select DIRECT STEREO.

The front panel display automatically dims.

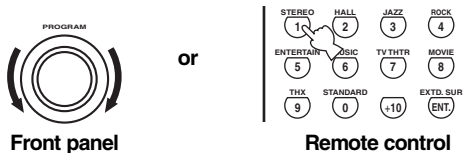

Direct Stereo

Notes

- To avoid unexpected noise, do not play DTS-encoded CDs in this mode.
- When multi-channel signals (Dolby Digital and DTS) are input, this unit automatically selects an analog signal input. (When DTS is selected as an input mode, no sound will be heard.)
- No sound will be output from the subwoofer.
- TONE CONTROL (page 35) and SET MENU (page 53) settings are not effective.

■ Night listening modes

The night listening modes are designed to improve listenability at lower volumes or at night. Choose either NIGHT:CINEMA or NIGHT:MUSIC depending on the type of material you are playing.

Press NIGHT on the remote control repeatedly to select cinema or music.

When night listening is selected, the NIGHT indicator in the front panel display lights up.



Remote control

- Select NIGHT:CINEMA when watching films to reduce the dynamic range of film soundtracks and make dialog easier to hear at lower volumes.
- Select NIGHT:MUSIC when listening to music sources to preserve ease-of-listening for all sounds.
- Select OFF if you do not want to use this function.

Press </> to adjust the effect level while NIGHT:CINEMA or NIGHT:MUSIC is displayed.

This adjusts the level of compression.

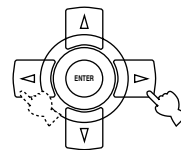

Remote control

Effect.Lvl:MID

- Select "MIN" for minimum compression.
- Select "MID" for standard compression.
- Select "MAX" for maximum compression.



NIGHT:CINEMA and NIGHT:MUSIC adjustments are stored independently.

Notes

- You cannot use the night listening modes with PURE DIRECT, MULTI CH INPUT, or when headphones are connected (even though the NIGHT indicator lights up when PURE DIRECT is selected).
- The night listening modes may vary in effectiveness depending on the input source and surround sound settings you use.

■ Downmixing to 2 channels

You can enjoy 2-channel stereo playback from multi-channel sources.

Rotate **PROGRAM** (or press **STEREO** on the remote control) to select **2ch Stereo**.

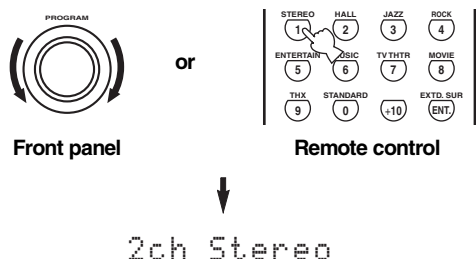

Note

You can use a subwoofer with this program when “SWFR” or “BOTH” is selected in LFE/BASS OUT.

■ Listening to unprocessed input signals

In **STRAIGHT** mode, two channel stereo sources are output from only the front left and right speakers. Multi-channel sources are decoded straight into the appropriate channels without any additional effect processing.

Press **STRAIGHT/EFFECT** to select **STRAIGHT**.

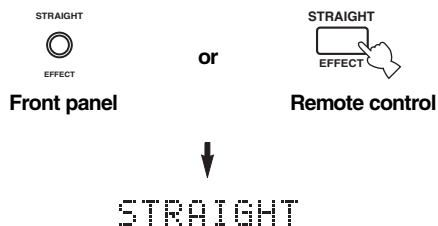

Press **STRAIGHT/EFFECT** again so that “**STRAIGHT**” disappears from the display when you want to turn the sound effect back on.

■ Virtual CINEMA DSP

Virtual CINEMA DSP allows you to enjoy the CINEMA DSP programs without surround speakers. It creates virtual speakers to reproduce a natural sound field. If you set **SURR L/R SP** to “**NONE**”, Virtual CINEMA DSP activates automatically whenever you select a CINEMA DSP sound field program.

Note

Virtual CINEMA DSP will not activate, even when **SURR L/R SP** is set to “**NONE**” (see page 56) in the following cases:

- When **MULTI CH INPUT** is selected as the input source.
- When headphones are connected to the **PHONES** jack.

■ Playing video sources in the background

You can combine images from a video source with sound from an audio source. For example, you can enjoy listening to classical music while having beautiful scenery from the video source on the video monitor.

Use the input selector buttons to select a video source, then select an audio source.

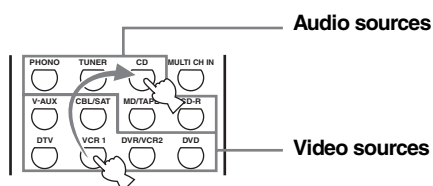

Note

If you want to enjoy an audio source connected to the **MULTI CH INPUT** jacks together with a video source, first select the video source and then press **MULTI CH INPUT**.

Selecting input modes

This unit comes with a variety of input jacks. Do the following to select the type of input signal you want to use.

1 Select the input source.

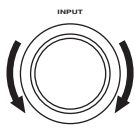

Front panel

or

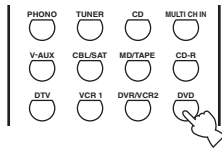

Remote control

2 Press INPUT MODE to select an input mode. In most cases, use AUTO.



Front panel

or

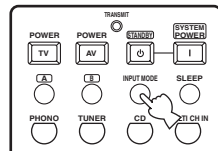

Remote control

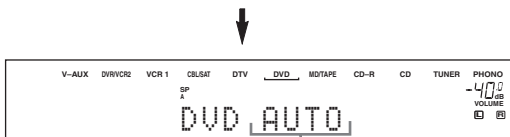

Input mode

- AUTO** Automatically selects input signals in the following order:
1) Digital signals*
2) Analog signals
- DTS** Selects only digital signals encoded in DTS. If no DTS signals are input, no sound is output.
- ANALOG** Selects only analog signals. If no analog signals are input, no sound is output.

* If this unit detects a Dolby Digital or DTS signal, the decoder automatically switches to the appropriate sound field program.



- You can adjust the default input mode this unit selects when the power is turned on (see page 61).
- DTS mode is recommended for playback of a CD or LD encoded in DTS.

Note

If the digital output data of the player has been processed in any way, you may not be able to perform DTS decoding even if you make a digital connection between this unit and the player.

■ Displaying information about the input source

You can display the type, format and sampling frequency of the current input signal.

1 Select the input source.

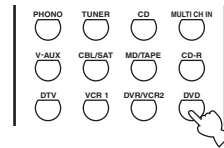

2 Set AMP/SOURCE/TV to AMP, then press STRAIGHT/EFFECT so that "STRAIGHT" appears in the display.



then



3 Press Δ / ∇ to display the following information about the input signal.

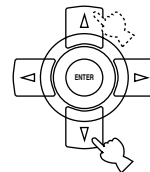

- (Format) Signal format display. When the unit cannot detect a digital signal it automatically switches to analog input.
- in Number of source channels in the input signal. For example, a multi-channel soundtrack with 3 front channels, 2 surround channels and LFE, is displayed as "3/2/LFE".
- f_s Sampling frequency. When the unit is unable to detect the sampling frequency "Unknown" appears.
- rate Bit rate. When the unit is unable to detect the bit rate "Unknown" appears.
- flg Flag data encoded with DTS or Dolby Digital signals that cue this unit to automatically switch decoders.

Note

The display shows "3/2/LFE" even when you play DTS-ES Discrete 6.1 sources that include 3 surround channels.

TUNING

Automatic and manual tuning

There are 2 tuning methods; automatic and manual. Automatic tuning is effective when station signals are strong and there is no interference.

Automatic tuning

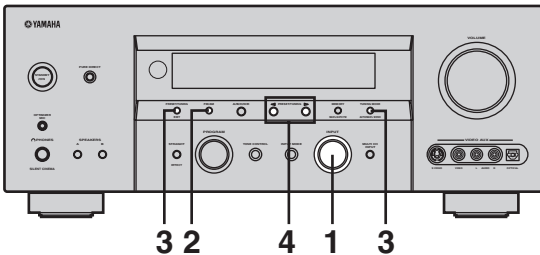

- 1 Rotate **INPUT** to select **TUNER** as the input source.

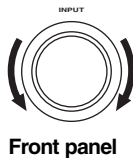

- 2 Press **FM/AM** to select the reception band. "FM" or "AM" appears in the front panel display.



- 3 Press **TUNING MODE (AUTO/MAN'L MONO)** so that the **AUTO** indicator lights up in the front panel display.



If a colon (:) appears in the front panel display, this unit is in PRESET mode and tuning is not possible. Press **PRESET/TUNING (EDIT)** to turn it off.

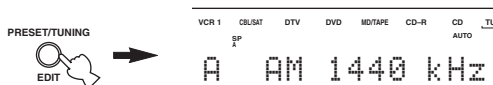

- 4 Press **PRESET/TUNING** </> once to begin automatic tuning.

Press > to tune into a higher frequency, or press < to tune into a lower frequency.

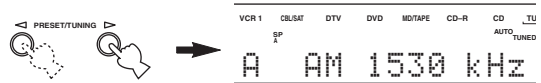

When tuned into a station, the **TUNED** indicator lights up and the frequency of the received station is shown in the front panel display.

Manual tuning

If the signal from the station you want to select is weak, you must tune into it manually. Manually tuning into an FM station will automatically change the reception mode to monaural to increase the signal quality.

- 1 Select **TUNER** and the reception band following steps 1 and 2 as described in "Automatic tuning".

- 2 Press **TUNING MODE (AUTO/MAN'L MONO)** so that the **AUTO** indicator disappears from the front panel display.



If a colon (:) appears in the front panel display, this unit is in PRESET mode and tuning is not possible. Press **PRESET/TUNING (EDIT)** to turn it off.

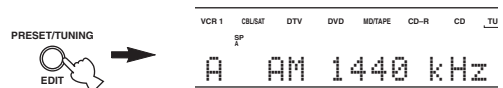

- 3 Press **PRESET/TUNING** </> to tune into the desired station manually.

Hold down the button to continue searching.



Presetting stations

■ Automatically presetting FM stations

You can use the automatic preset tuning feature to store FM stations. This function enables this unit to automatically tune into FM stations with strong signals, and to store up to 40 (8 stations in 5 groups, A1 through E8) of those stations in order. You can then recall any preset station easily by selecting the preset station number.

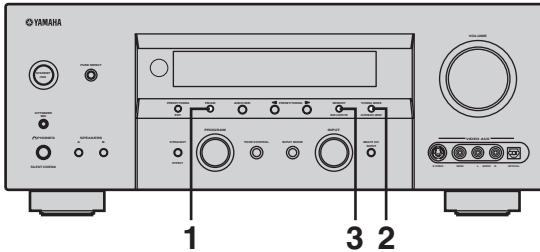

1 Press FM/AM to select the FM band.



2 Press TUNING MODE (AUTO/MAN'L MONO) so that the AUTO indicator lights up in the front panel display.



3 Press and hold MEMORY (MAN'L/AUTO FM) for more than 3 seconds.

The preset number, the MEMORY and AUTO indicators flash. After about 5 seconds, automatic presetting starts from the frequency currently displayed and proceeds toward the higher frequencies.

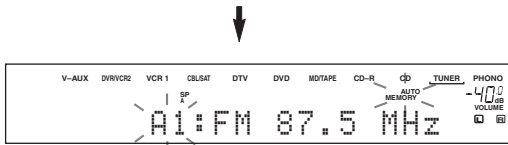

When automatic preset tuning is completed, the front panel display shows the frequency of the last preset station.

Notes

- Any stored station data existing under a preset number is cleared when you store a new station under that preset number.
- If the number of the received stations does not reach 40 (E8), automatic preset tuning has automatically stopped after searching all stations.
- Only FM stations with sufficient signal strength are stored automatically by automatic preset tuning. If the station you want to store is weak in signal strength, tune into it manually and store it by following the procedure in "Manually presetting stations".

Automatic preset tuning options

You can select the preset number from which this unit will store FM stations and/or begin tuning toward lower frequencies.

After pressing MEMORY in step 3:

- 1 Press A/B/C/D/E, then PRESET/TUNING </> to select the preset number under which the first station will be stored. Automatic preset tuning will stop when stations have all been stored up to E8.
- 2 Press PRESET/TUNING (EDIT) to turn off the colon (:), and then press PRESET/TUNING < to begin tuning toward lower frequencies.

Memory back-up

The memory back-up circuit prevents the stored data from being lost even if this unit is set in the standby mode, the power cord is disconnected from the AC outlet, or the power supply is temporarily cut due to power failure. However, if the power is cut for more than one week, the preset stations may be cleared. If so, store the stations again by using the presetting station methods.

Manually presetting stations

You can also tune up to 40 FM or AM stations (8 stations in 5 groups, A1 through E8) manually.

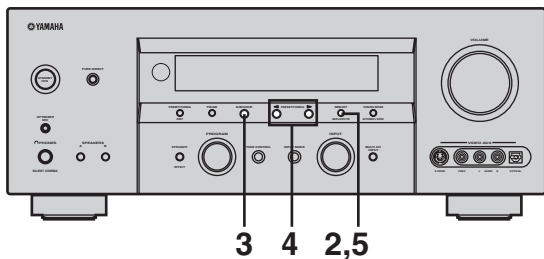

1 Tune into a station.

See page 41 for tuning instructions.

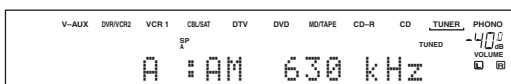

When tuned into a station, the front panel display shows the frequency of the station received.

2 Press MEMORY (MAN'L/AUTO FM).

The MEMORY indicator flashes for about 5 seconds.



3 Press A/B/C/D/E repeatedly to select a preset station group (A through E) while the MEMORY indicator is flashing.

The group letter appears. Check that the colon (:) appears in the front panel display.

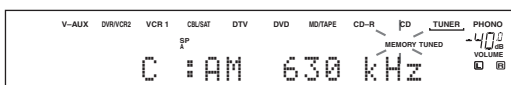

4 Press PRESET/TUNING </> to select a preset station number (1 through 8) while the MEMORY indicator is flashing.

Press > to select a higher preset station number.

Press < to select a lower preset station number.

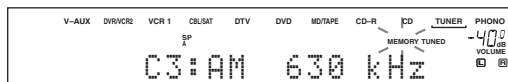
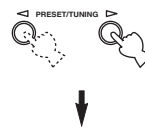

5 Press MEMORY (MAN'L/AUTO FM) on the front panel while the MEMORY indicator is flashing.

The station band and frequency appear in the front panel display with the preset group and number you have selected.

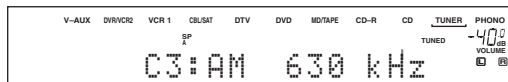

Shows the displayed station has been stored as C3.

6 Repeat steps 1 through 5 to store other stations.

Notes

- Any stored station data existing under a preset number is cleared when you store a new station under that preset number.
- The reception mode (stereo or monaural) is stored along with the station frequency.

Selecting preset stations

You can tune any desired station simply by selecting the preset station number under which it was stored.

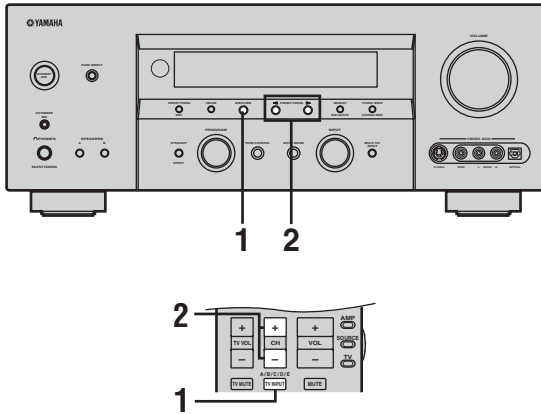

When performing this operation with the remote control, first set AMP/SOURCE/TV to SOURCE then press TUNER to set the remote to tuner mode.

1 Press A/B/C/D/E to select the preset station group.

The preset group letter appears in the front panel display and changes each time you press the button.

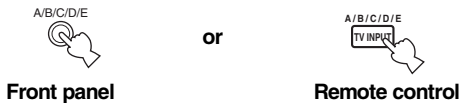

2 Press PRESET/TUNING </> (PRESET +/- on the remote control) to select a preset station number (1 through 8).

The preset group and number appear in the front panel display along with the station band, frequency and the TUNED indicator lights up.

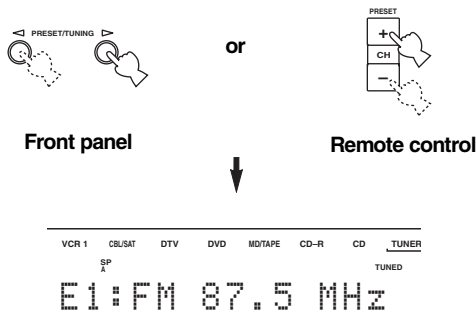

Exchanging preset stations

You can exchange the assignment of two preset stations with each other. The example below describes the procedure for exchanging preset station "E1" with "A5".

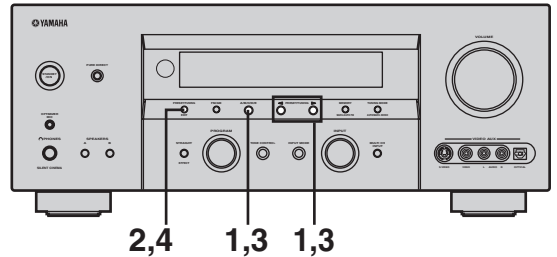

1 Select preset station "E1" using A/B/C/D/E and PRESET/TUNING </>.

See "Selecting preset stations".

2 Press and hold PRESET/TUNING (EDIT) for more than 3 seconds.

"E1" and the MEMORY indicator flash in the front panel display.

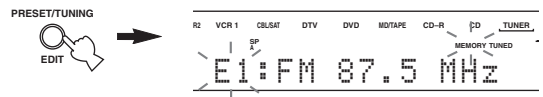

3 Select preset station "A5" by using A/B/C/D/E and PRESET/TUNING </>.

"A5" and the MEMORY indicator flash in the front panel display.



4 Press PRESET/TUNING (EDIT) again.

The stations stored at the two preset assignments are exchanged.



RECORDING

Recording adjustments and other operations are performed from the recording components. Refer to the operation instructions for those components.

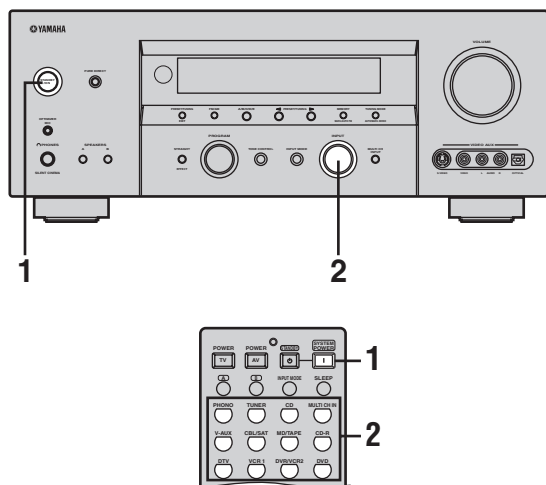

1 Turn on the power of this unit and all connected components.

2 Select the source component you want to record from.

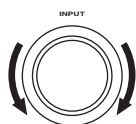

Front panel

or

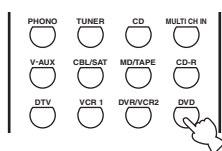

Remote control

3 Start playback (or select a broadcast station) on the source component.

4 Start recording on the recording component.



Always do a test recording before you start an actual recording.

Notes

- When this unit is set in the standby mode, you cannot record between other components connected to this unit.
- The setting of TONE CONTROL, VOLUME, SPEAKER LEVEL (page 57) and programs does not affect recorded material.
- A source connected to the MULTI CH INPUT jacks of this unit cannot be recorded.
- S-video and composite video signals pass independently through this unit's video circuits. Therefore, when recording or dubbing video signals, if your video source component is connected to provide only an S-video (or only a composite video) signal, you can record only an S-video (or only a composite video) signal to your VCR.
- Digital signals input to the DIGITAL INPUT jacks are not output to the analog AUDIO OUT (L/R) jacks for recording. Likewise, analog signals input to the AUDIO IN (L/R) jacks are not output to the DIGITAL OUTPUT jack. Therefore, if your source component is connected to provide only digital (or analog) signals, you can only record digital (or analog) signals.
- A given input source is not output on the same REC OUT channel. (For example, the signal input from VCR 1 IN is not output on VCR 1 OUT.)
- Check the copyright laws in your country to record from records, CDs, radio, etc. Recording of copyrighted material may infringe copyright laws.

If you playback a video source that uses scrambled or encoded signals to prevent it from being dubbed, the picture itself may be disturbed due to those signals.

Special considerations when recording DTS software

The DTS signal is a digital bitstream. Attempting to digitally record the DTS bitstream will result in noise being recorded. Therefore, if you want to use this unit to record sources that have DTS signals recorded on them, the following considerations and adjustments need to be made.

For DVDs and CDs encoded with DTS, when your player is compatible with the DTS format, follow its operation instruction to make a setting so that the analog signal will be output from the player.

SOUND FIELD PROGRAM DESCRIPTIONS

This unit is equipped with a variety of precise digital decoders that allow you to enjoy multi-channel playback from almost any sound source (stereo or multi-channel). This unit is also equipped with a YAMAHA digital sound field processing (DSP) chip containing several sound field programs which you can use to enhance your playback experience. Most of these sound field programs are precise digital recreations of actual acoustic environments found in famous concert halls, music venues, and movie theaters.



The YAMAHA CINEMA DSP modes are compatible with all Dolby Digital, DTS, and Dolby Surround sources. Set the input mode to AUTO (see page 40) to enable this unit to automatically switch to the appropriate digital decoder according to the input signal.

Notes

- This unit's DSP sound field programs are recreations of real-world acoustic environments made from precise measurements taken in actual halls, etc. Thus you may notice variations in the strength of the reflections coming from the front, back, left and right.
- Feel free to choose a sound field program based on your listening preference, and not purely on the name of the program itself.

For movie/video sources

You can select from the following sound fields when playing movie or video sources. The sound fields marked "MULTI" can be used with multi-channel sources, like DVD, digital TV, etc. Those marked "2-CH" can be used with 2-channel (stereo) sources like TV programs, video tapes, etc.

Program	Features	Sources
STEREO: 2ch Stereo	Downmixes multi-channel sources to 2 (left and right) channels or plays back 2-channel sources as is.	MULTI 2-CH
MUSIC VIDEO	This program lends an enthusiastic atmosphere to the sound, giving you the feeling that you are at an actual jazz or rock concert.	
ENTERTAINMENT: Game	This program adds a deep and spatial feeling to video game sounds.	
TV THEATER: Mono Movie	This program is provided for reproducing monaural video sources (such as old movies). The program produces the optimum reverberation to create sound depth using only the presence sound field.	
TV THEATER: Variety/Sports	Though the presence sound field is relatively narrow, the surround sound field employs the sound environment of a large concert hall. This effect enhances the experience of watching various TV programs such as news, variety shows, music programs or sports programs.	
MOVIE THEATER: Spectacle	CINEMA DSP processing. This program creates the extremely wide sound field of a 70-mm movie theater. It precisely reproduces the source sound in detail, making both the video and the sound field incredibly real. This is ideal for any kind of video source encoded with Dolby Surround, Dolby Digital or DTS (especially large-scale movie productions).	
MOVIE THEATER: Sci-Fi	CINEMA DSP processing. This program clearly reproduces dialog and sound effects in the latest sound form for science fiction films, thus creating a broad and expansive cinematic space amid silence. You can enjoy science fiction films in a virtual-space sound field that includes Dolby Surround, Dolby Digital and DTS-encoded software employing the most advanced techniques.	
MOVIE THEATER: Adventure	CINEMA DSP processing. This program is ideal for precisely reproducing the sound design of the newest 70-mm and multi-channel soundtrack films. The sound field is made to be similar to that of the newest movie theaters, so the reverberations of the sound field itself are restrained as much as possible.	
MOVIE THEATER: General	CINEMA DSP processing. This program is for reproducing sounds from 70-mm and multi-channel soundtrack films, and is characterized by soft and extensive sound field. The presence sound field is relatively narrow. It spatially spreads all around and toward the screen, restraining the echo effect of conversations without losing clarity.	
THX: THX Cinema	THX processing for any multi-channel source. 2-channel sources are decoded by the PRO LOGIC, PRO LOGIC II, PRO LOGIC IIx or DTS Neo: 6 decoder before THX processing.	

Program	Features	Sources
THX: THX Surr. EX	THX processing for Dolby Digital and Dolby Digital EX sources. This program is available only when surround back L/R speakers are connected to this unit and when the input source contains surround back channel signals.	MULTI
THX: dts ES + THX	THX processing for DTS-ES sources.	
DOLBY DIGITAL: SUR. STANDARD	Standard 5.1 channel processing for Dolby Digital sources.	
DOLBY DIGITAL: SUR. ENHANCED	CINEMA DSP enhanced processing for Dolby Digital sources.	
DD D+PLIIXMovie: SUR. STANDARD	Standard 7.1 channel processing for Dolby Digital sources.	
DD D+PLIIXMovie: SUR. ENHANCED	CINEMA DSP enhanced 7.1 channel processing for Dolby Digital sources.	
DOLBY D EX: SUR. STANDARD	Standard 6.1 channel processing for Dolby Digital sources.	
DOLBY D EX: SUR. ENHANCED	CINEMA DSP enhanced 6.1 channel processing (Dolby Digital EX) for Dolby Digital sources.	
DTS: SUR. STANDARD	Standard 5.1 channel processing for DTS sources.	
DTS: SUR. ENHANCED	CINEMA DSP enhanced processing for DTS and 96kHz/24-bit DTS sources.	
DTS 96/24: SUR. STANDARD	Standard 5.1 channel processing for 96kHz/24-bit DTS sources.	
DTS+PLIIX Movie: SUR. STANDARD	Standard 7.1 channel processing (Dolby Pro Logic IIX) for DTS sources.	
DTS+PLIIX Movie: SUR. ENHANCED	CINEMA DSP enhanced 7.1 channel processing (Dolby Pro Logic IIX) for DTS sources.	
DTS+DOLBY EX: SUR. STANDARD	Standard 6.1 channel processing (Dolby Digital EX) for DTS sources.	
DTS+DOLBY EX: SUR. ENHANCED	CINEMA DSP enhanced 6.1 channel processing (Dolby Digital EX) for DTS sources.	
DTS ES MtrX6.1: SUR. STANDARD	Standard 6.1 channel processing (DTS-ES Matrix) for DTS sources.	
DTS ES MtrX6.1: SUR. ENHANCED	CINEMA DSP enhanced processing (DTS-ES Matrix) for DTS and 96kHz/24-bit DTS sources.	
DTS ES Disc6.1: SUR. STANDARD	Standard 6.1 channel processing (DTS-ES Discrete) for DTS sources.	
DTS ES Disc6.1: SUR. ENHANCED	CINEMA DSP enhanced processing (DTS-ES Discrete) for DTS sources.	
DTS 96/24 ES: SUR. STANDARD	Standard 6.1 channel processing (DTS-ES Matrix) for 96kHz/24-bit DTS sources.	

SOUND FIELD PROGRAM DESCRIPTIONS

Program	Features	Sources
PRO LOGIC: SUR. STANDARD	Standard processing for Dolby Surround sources.	2-CH
PRO LOGIC: SUR. ENHANCED	CINEMA DSP enhanced processing for Dolby Surround sources.	
PRO LOGIC IIx: PLIIx Movie	Dolby Pro Logic IIx processing for movie software.*	
PRO LOGIC II: PLII Movie	Dolby Pro Logic II processing for movie software.*	
PRO LOGIC IIx: PLIIx Game	Dolby Pro Logic IIx processing for game software.*	
PRO LOGIC II: PLII Game	Dolby Pro Logic II processing for game software.*	
DTS: Neo:6 Cinema	DTS processing for movie software.	

* You can select either Pro Logic IIx or Pro Logic II processing using the PLII/PLIIx parameter on page 85.

For music sources

You can select from the following sound fields when playing music sources, like CD, FM/AM broadcasting, tapes, etc.

Program	Features	Sources
CONCERT HALL	HiFi DSP processing. A classic shoe-box type concert hall with approximately 1700 seats. Pillars and ornate carvings create extremely complex reflections which produce a very full, rich sound.	MULTI 2-CH
JAZZ CLUB	HiFi DSP processing. This is the sound field at stage front in "The Bottom Line", a famous New York jazz club. The floor can seat 300 people to the left and right in a sound field offering a real and vibrant sound.	
ROCK CONCERT	HiFi DSP processing. The ideal program for lively, dynamic rock music. The data for this program was recorded at LA's "hottest" rock venue. The listener's virtual seat is at the center-left of the hall.	
ENTERTAINMENT: Disco	HiFi DSP processing. This program recreates the acoustic environment of a lively disco in the heart of a big city. The sound is dense and highly concentrated. It is also characterized by a high-energy, "immediate" sound.	
DD D+PLIIxMusic: SUR. STANDARD	Standard Dolby Digital and Dolby Pro Logic IIx processing for music sources.	MULTI
DD D+PLIIxMusic: SUR. ENHANCED	DSP enhanced Dolby Digital and Dolby Pro Logic IIx processing for music sources.	
DTS+PLIIx Music: SUR. STANDARD	Standard DTS and Dolby Pro Logic IIx processing for music sources.	
DTS+PLIIx Music: SUR. ENHANCED	DSP enhanced DTS and Dolby Pro Logic IIx processing for music sources.	
STEREO: 2ch Stereo	2 (left and right) channel playback.	2-CH
STEREO: Direct Stereo	Use to output stereo sources to only the front left and right speakers without any processing.	
STEREO: 7ch Stereo	Use to increase the output stereo sources (in stereo) from all speakers. This provides a larger sound field and is ideal for background music at parties, etc.	
PRO LOGIC IIx: PLIIx Music	Dolby Pro Logic IIx processing for music software.*	
PRO LOGIC II: PLII Music	Dolby Pro Logic II processing for music software.*	
DTS: Neo:6 Music	DTS processing for music software.	

* You can select either Pro Logic IIx or Pro Logic II processing using the PLII/PLIIx parameter on page 85.

ADVANCED OPERATIONS

Selecting the OSD mode

You can display this unit's operating information on a video monitor. If you display the SET MENU and sound field program parameter settings on a monitor, it is much easier to see the available options and parameters than it is by reading this information in the front panel display.

1 Turn on the video monitor connected to this unit.

2 Press ON SCREEN repeatedly to change the OSD mode.

The OSD mode changes in the following order: full display, short display, and display off.



Full display

Always shows the sound field program parameter settings as well as the contents of the front panel display.

Short display

Briefly shows the contents of the front panel display at the bottom of the screen each time you operate this unit.

Display off

Only operations performed using ON SCREEN are displayed. The OSD is displayed when using SET MENU or the test tone feature, even if the OSD mode is set to "Display off".

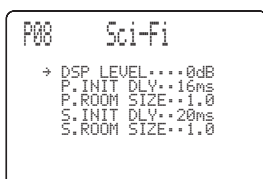

Full display

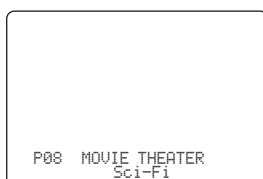

Short display

Notes

- The OSD signal is not output to the REC OUT jack, and will not be recorded.
- When the component video signals are input, short display is not output to the COMPONENT VIDEO MONITOR OUT jacks.
- You can set the OSD to turn on (gray background) or off when a video source is not being reproduced (or the source component is turned off) by using DISPLAY SET (see page 62).

Using the sleep timer

Use this feature to automatically set this unit in the standby mode after a certain amount of time. The sleep timer is useful when you are going to sleep while this unit is playing or recording a source. The sleep timer also automatically turns off any external components connected to the AC OUTLETS.

Setting the sleep timer

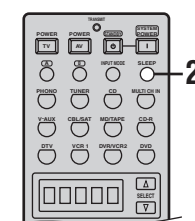

1 Select a source and start playback on the source component.

2 Press SLEEP repeatedly to set the amount of time.

Each time you press SLEEP, the front panel display changes as shown below. The SLEEP indicator flashes while switching the amount of time for the sleep timer.

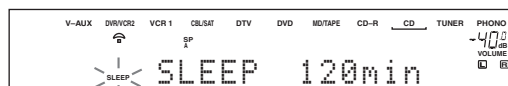
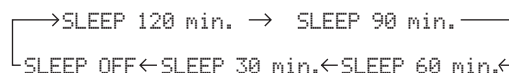

The SLEEP indicator lights up in the front panel display, and the display returns to the selected sound field program.



■ Canceling the sleep timer

Press SLEEP repeatedly until "SLEEP OFF" appears in the front panel display.

After a few seconds, "SLEEP OFF" disappears, and the SLEEP indicator goes off.



The sleep timer setting can also be canceled by pressing STANDBY on the remote control (or STANDBY/ON on the front panel) to set this unit to the standby mode.

Manually adjusting speaker levels

You can adjust the output level of each speaker while listening to a music source. This is also possible when playing sources through the MULTI CH INPUT jacks. Please note that this operation will override the level adjustments made in "AUTO SETUP" (page 26), "Speaker level" (page 57) and "Using the test tone" (page 52).

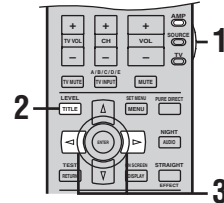

1 Set AMP/SOURCE/TV to AMP.

2 Press LEVEL repeatedly to select the speaker you want to adjust.

FRONT L	Front left speaker level
CENTER	Center speaker level
FRONT R	Front right speaker level
SUR. R	Surround right speaker level
SUR. B. R	Surround back right speaker level
SUR. B. L	Surround back left speaker level
SUR. L	Surround left speaker level
SWFR	Subwoofer level
PRES	Presence speaker level



Once you press LEVEL, you can also select the speaker by pressing Δ / ∇ .

3 Press \triangleleft / \triangleright to adjust the speaker output level.

The control range is from +10 dB to -10 dB.

Using the test tone

You can use the test tone feature to manually balance your speaker levels. Please note that this operation will override the level adjustments made in “AUTO SETUP” (page 26), “Speaker level” (page 57) and “Manually adjusting speaker levels” (page 51). Use the test tone to set speaker levels so that the volume from each speaker is identical when heard from your listening position.

Note

You cannot activate the test tone if headphones are connected to the PHONES jack. Remove the headphones from the PHONES jack.

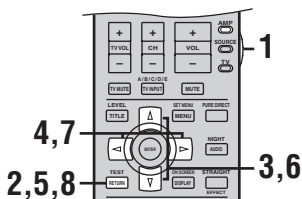

1 Set AMP/SOURCE/TV to AMP.

2 Press TEST.

The unit outputs a test tone.

3 Press Δ / ∇ repeatedly to select the speaker you want to adjust.

TEST LEFT	Front left speaker
TEST CENTER	Center speaker
TEST RIGHT	Front right speaker
TEST SUR. R	Surround right speaker
TEST SUR. B. R	Surround back right speaker
TEST SUR. B. L	Surround back left speaker
TEST SUR. L	Surround left speaker
TEST SUBWOOFER	Subwoofer

4 Press \triangleleft / \triangleright to adjust speaker volumes.

5 Press TEST when you have completed your adjustment.

If PRESENCE SP in SPEAKER SET is set to “YES” (see page 56), proceed to step 6 to adjust the presence speaker volumes.

If PRESENCE SP in SPEAKER SET is set to “NONE”, the test tone stops.

6 Press Δ / ∇ repeatedly to select the speaker(s) you want to output the test tone.

TEST FRONT	Front speakers
TEST PRESENCE	Presence speakers
TEST PRES L	Presence left speaker
TEST PRES R	Presence right speaker

7 Press \triangleleft / \triangleright to adjust the presence speaker volumes.

8 Press TEST when you have completed your adjustment.

The test tone stops.



- If you use a handheld SPL meter, hold at arms length and point upwards so that the meter is in the listening position. With the meter set to the 70 dB scale and to C SLOW, calibrate each speaker to 75 dB.
- Before outputting the test tone, we recommend that you set the output volume to 0 dB.

SET MENU

You can use the following parameters in SET MENU to adjust a variety of system settings and customize the way this unit operates. Change the initial settings (indicated in bold under each parameter) to reflect the needs of your listening environment.

■ AUTO SETUP

Use to specify which speaker parameters auto setup will adjust, and to activate the auto setup procedure (see page 26).

■ MANUAL SETUP

Use to manually adjust speaker and system settings.

BASIC MENU

Use to quickly setup basic system parameters (see page 31).

SOUND MENU

Use to manually adjust any speaker setting, alter the quality and tone of the sound output by the system or compensate for video signal processing delays when using LCD monitors or projectors.



Most of the parameters described in SOUND MENU are set automatically when you run auto setup (see page 26). You can use SOUND MENU to make further adjustments, but we recommend running auto setup first.

Item	Features	Page
A)SPEAKER SET	Selects the size of each speaker, the speakers for low-frequency signal output, and the cross over frequency.	55
B)SPEAKER LEVEL	Adjusts the output level of each speaker.	57
C)SP DISTANCE	Adjusts the delay time of each speaker.	57
D)GRAPHIC EQ	Adjusts the tonal quality of each speaker.	58
E)LFE LEVEL	Adjusts the output level of the LFE channel for Dolby Digital or DTS signals.	58
F)DYNAMIC RANGE	Adjusts the dynamic range for Dolby Digital or DTS signals.	58
G)LOW FRQ. TEST	Matches the subwoofer level with the level of the other speakers.	59
H)HP TONE CTRL	Adjusts the tonal balance of the headphones.	59
I)AUDIO SET	Customizes overall audio settings of this unit.	59
J)PR/SBch SELECT	Selects priority to either surround back or presence speakers when both sets of speakers are connected to this unit.	60

INPUT MENU

Use to reassign digital input/outputs, select the input mode, rename your inputs, or specify external input settings.

Item	Features	Page
A)I/O ASSIGNMENT	Assigns jacks according to the component to be used.	60
B)INPUT MODE	Selects the initial input mode of the source.	61
C)INPUT RENAME	Changes the name of the inputs.	61
D)MULTI CH INPUT	Sets the direction of the signals input into the center, subwoofer and surround channels for the source component connected to the MULTI CH INPUT jacks.	62

OPTION MENU

Use to adjust the optional system settings.

Item	Features	Page
A)DISPLAY SET	Adjusts the settings of the OSD and the front panel display and converts video signals.	62
B)MEMORY GUARD	Locks sound field program parameters and other SET MENU settings.	63
C)PARAM. INI	Initializes the parameters of a group of sound field programs.	63
D)SP IMP. SET	Selects the impedance of your speakers.	63
E)ZONE SET	Specifies the location of the speakers connected to the SPEAKERS B terminals.	64
F)ZONE2 SET	Selects the Zone 2 mode.	64
G)ZONE3 SET	Selects the Zone 3 mode.	64

Using SET MENU

Use the remote control to access and adjust each parameter.

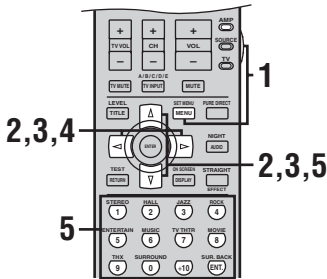

You can change SET MENU parameters while the unit is reproducing sound.

Note

You cannot change some SET MENU parameters while the unit is in either cinema or music night listening mode.

- 1 Set AMP/SOURCE/TV to AMP, then press SET MENU to enter the SET MENU.**



- 2 Press Δ / ▽ to select AUTO SETUP or MANUAL SETUP, then press ◀ / ▶ to enter the selected category.**

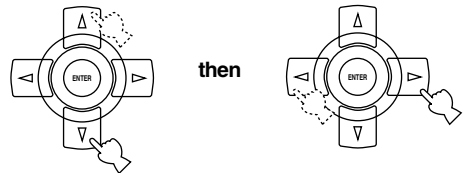

Note

If Δ is pressed when AUTO SETUP is selected, or if ▽ is pressed when MANUAL SETUP is selected, SET MENU will be closed. Press SET MENU to open SET MENU again.

- 3 Press Δ / ▽ repeatedly to select a menu, then press ◀ / ▶ to enter the menu item.**

Repeat this operation to navigate to and enter the setup mode of the item you want to adjust.

4 Press ◀/▶ repeatedly to change the setting of the item you want to adjust.

5 To exit, press ▲/▼ repeatedly until the menu disappears or just press one of the sound field program group buttons.

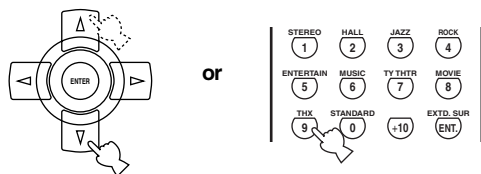

Memory back-up

The memory back-up circuit prevents the stored data from being lost even if this unit is in the standby mode. However, if the power cord is disconnected from the AC outlet, or the power supply is cut for more than one week, the stored data will be lost. If so, adjust the items again.

Using SOUND MENU

Use to manually adjust any speaker setting or compensate for video signal processing delays when using LCD monitors or projectors. Most of the SOUND parameters are set automatically when you run auto setup (see page 26).

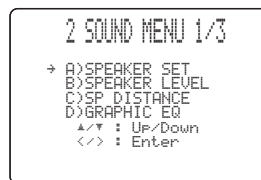

■ Speaker set A)SPEAKER SET

Use to manually adjust any speaker setting.



If you are not satisfied with the bass sounds from your speakers, you can change these settings according to your preference.

Note

Set any THX speakers to SMALL (SML).

Center speaker CENTER SP

Choices: NONE, **SML**, LRG

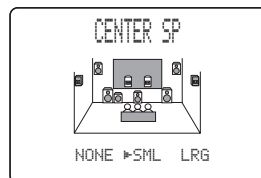

- Select “NONE” if you do not have a center speaker. The unit directs all of the center channel signal to the front left and right speakers.
- Select “SML” if you have a small center speaker. The unit directs the low-frequency signals of the center channel to the speakers selected in LFE/BASS OUT.
- Select “LRG” if you have a large center speaker. The unit directs the entire range of the center channel signal to the center speaker.

Front speakers FRONT SP

Choices: **SMALL**, LARGE

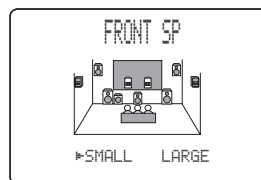

- Select “SMALL” if you have small front speakers. The unit directs the low-frequency signals of the front channel to the speakers selected in LFE/BASS OUT.
- Select “LARGE” if you have large front speakers. The unit directs the entire range of the front left and right channel signals to the front left and right speakers.

Surround left/right speakers SURR L/R SP

Choices: NONE, **SML**, LRG

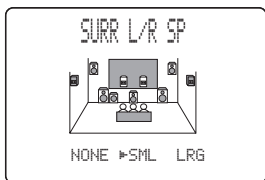

- Select “NONE” if you do not have surround speakers. This will set the unit to the Virtual CINEMA DSP mode (see page 39) and automatically set the surround back speaker setting (SURR B L/R SP) to “NONE”.
- Select “SML” if you have small surround left and right speakers. The low-frequency signals of the surround channel are directed to the speakers selected in LFE/BASS OUT.
- Select “LRG” if you have large surround left and right speakers or if a rear subwoofer is connected to the surround speakers. The entire range of the surround channel signal is directed to the surround left and right speakers.

Surround back speakers SURR B L/R SP

Choices: LRGx2, LRGx1, **SMLx2**, SMLx1, NONE

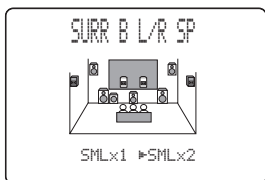

- Select “LRGx2” if you have 2 large surround back speakers. The unit directs the entire range of the surround back channel signal to the surround back speakers.
- Select “LRGx1” if you have a large surround back speaker. The unit directs the entire range of the surround back channel signal to the left surround back speaker.
- Select “SMLx2” if you have 2 small surround back speakers. The low-frequency signals of the surround back channels are directed to the speakers selected in LFE/BASS OUT.
- Select “SMLx1” if you have a small surround back speaker. The low-frequency signals of the surround back channel are directed to the speakers selected in LFE/BASS OUT, and the rest of the frequency signals are directed to the left surround back speaker.
- Select “NONE” if you do not have a surround back speaker. The unit directs all of the surround back channel signal to the surround left and right speakers.

Note

If you select “LRGx1” or “SMLx1”, connect the speaker to the left SURROUND BACK speaker terminals.

Presence speakers PRESENCE SP

Choices: NONE, **YES**



- Select “YES” if you have presence speakers.
- Select “NONE” if you do not have presence speakers.

LFE/bass out LFE/BASS OUT

Low-frequency (bass) signals can be directed to the subwoofer and/or the front left and right speakers according to the characteristics of your system. This setting also determines the routing of the LFE (low-frequency effect) signals found in Dolby Digital or DTS sources.

Choices: **SWFR** (subwoofer), FRNT, BOTH
THX recommendation: SWFR

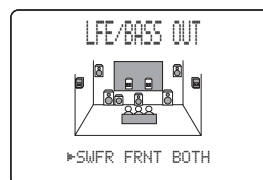

- Select “SWFR” if you connect a subwoofer. LFE and low-frequency signals from other channels are directed to the subwoofer according to the speaker settings.
- Select “FRNT” if you do not use a subwoofer. LFE and low frequency signals from other channels are directed to the front speakers according to the speaker settings (even if you have previously set front speakers to SML).
- Select “BOTH” if you connect a subwoofer and you want to output low-frequency signals from front channels to both the front speakers and subwoofer. LFE and low-frequency signals from other channels are also directed to the subwoofer according to the speaker settings. Use this function to reinforce low-frequency signals using the subwoofer when playing back sources such as CDs.

Cross over CROSS OVER

Use this feature to select a cross-over (cut-off) frequency for all low-frequency signals. All frequencies below the selected frequency will be sent to the subwoofer.

Choices: 40Hz, 60Hz, **80Hz (THX)**, 90Hz, 100Hz, 110Hz, 120Hz, 160Hz, 200Hz

THX recommendation: "80Hz"

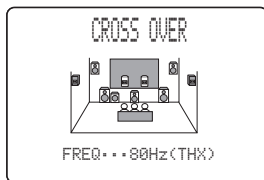

Speaker level B>SPEAKER LEVEL

Use these settings to manually balance the speaker levels between the front left (or surround left) speaker and each speaker selected in SPEAKER SET (page 55).

Choices: -10.0 dB to +10.0 dB

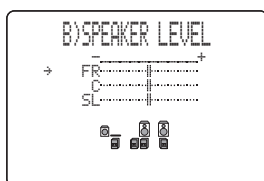

- **FR** adjusts the balance of the front left and front right speakers.
- **C** adjusts the balance of the front left and center speakers.
- **SL** adjusts the balance of the front left and surround left speakers.
- **SBL*** adjusts the balance of the surround left and surround back left speakers.
- **SBR*** adjusts the balance of the surround left and surround back right speakers.
- **SR** adjusts the balance of the surround left and surround right speakers.
- **SWFR** adjusts the balance of the front left speaker and subwoofer.
- **PRES** adjusts the balance of the front and presence speakers.

* SB will be displayed if you selected only one surround back speaker in SURR B L/R SP (page 56).



If you use a handheld SPL meter, hold at arms length and point upwards so that the meter is in the listening position. With the meter set to the 70 dB scale and to C SLOW, calibrate each speaker to 75 dB.

Speaker distance C>SP DISTANCE

Use this feature to manually input the distance of each speaker and adjust the delay applied to respective channel. Ideally, each speaker should be the same distance from the main listening position. However, this is not possible in most home situations. Thus, a certain amount of delay must be applied to the sound from each speaker so that all sounds arrive at the listening position at the same time.

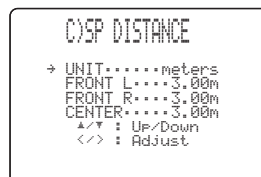

Unit UNIT

Choices: **meters** (m), feet (ft)

Initial setting: feet (ft)

- Select "meters" to input speaker distances in meters.
- Select "feet" to input speaker distances in feet.

Speaker distances

Choices: 0.3 to 24.00 m (1 to 80 ft)

- **FRONT L** adjusts the distance of the front left speaker. Initial setting: 3.0 m (10.0 ft)
- **FRONT R** adjusts the distance of the front right speaker. Initial setting: 3.0 m (10.0 ft)
- **CENTER** adjusts the distance of the center speaker. Initial setting: 3.0 m (10.0 ft)
- **SURR L** adjusts the distance of the surround left speaker. Initial setting: 3.0 m (10.0 ft)
- **SURR R** adjusts the distance of the surround right speaker. Initial setting: 3.0 m (10.0 ft)
- **SB L*** adjusts the distance of the surround back left speaker. Initial setting: 2.10 m (7.0 ft)
- **SB R*** adjusts the distance of the surround back right speaker. Initial setting: 2.10 m (7.0 ft)
- **SWFR** adjusts the distance of the subwoofer. Initial setting: 3.0 m (10.0 ft)
- **PRES L** adjusts the distance of the presence left speaker. Initial setting: 3.0 m (10.0 ft)
- **PRES R** adjusts the distance of the presence right speaker. Initial setting: 3.0 m (10.0 ft)

* "SURR B" will be displayed if you selected only one surround back speaker in SURR B L/R SP (page 56).

■ **Graphic equalizer** D)GRAPHIC EQ

Use this feature to select parametric (PEQ) or graphic equalizer (GEQ).

Equalizer select EQ SELECT

Choices: PEQ, GEQ

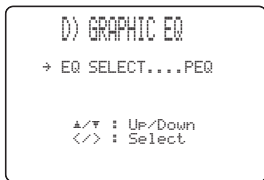

- Select “PEQ” to use the equalizer adjusted in auto setup.
- Select “GEQ” to adjust the built-in 7-band graphic equalizer (see “Equalizer” below).

Equalizer

Use to match the tonal quality of the center, surround L/R and surround back L/R speakers with that of the front L/R speakers.

Choices: -6 to +6 (dB)

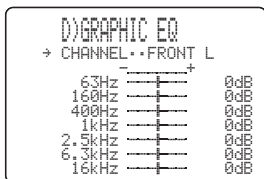

You can adjust 7 frequency bands: 63Hz, 160Hz, 400Hz, 1kHz, 2.5kHz, 6.3kHz, 16kHz

■ **Low-frequency effect level** E)LFE LEVEL

Use to adjust the output level of the LFE (low-frequency effect) channel according to the capacity of your subwoofer or headphones. The LFE channel carries low-frequency special effects which are only added to certain scenes. This setting is effective only when this unit decodes Dolby Digital or DTS signals.

Choices: -20 to 0 (dB)



Speaker SPEAKER

Select to adjust the speaker LFE level.

Headphone HEADPHONE

Select to adjust the headphone LFE level.

Note

Depending on the settings of LFE LEVEL, some signals may not be output from the SUBWOOFER PRE OUT jack.

■ **Dynamic range** F)DYNAMIC RANGE

Use to select the amount of dynamic range compression to be applied to your speakers or headphones. This setting is effective only when the unit is decoding Dolby Digital and DTS signals.

Choices: MIN (minimum), STD (standard),

MAX (maximum)



Speaker SP

Select to adjust the speaker compression.

Headphone HP

Select to adjust the headphone compression.

- Select “MIN” if you regularly listen at low volume levels.
- Select “STD” for general use.
- Select “MAX” to preserve the greatest amount of dynamic range.

■ Low frequency test G>LOW FRQ. TEST

Use this feature to adjust the output level of the subwoofer so it matches your other speakers.



1 Press </> to set TEST TONE to ON, and adjust the volume with VOL +/- so you can hear the tone.

Do not turn up the volume too high. If no test tone is heard, turn down the volume, set this unit in the standby mode and make sure all the necessary connections are correct.

The tone generator produces a narrow-band noise centered on a specified frequency by the band pass filter, as well as a wide-band noise.

2 Press ▽ to go to OUTPUT and press </> to select the speaker you want to compare with the subwoofer.

Choices: **FRONT L/R**, FRONT L, CENTER, FRONT R, SUR.R, SBR*, SBL*, SUR.L, SWFR, PRESENCE

* "SB" will be displayed if you selected only one surround back speaker in SURR B L/R SP (page 56).

3 Press ▽ to go to FRQ and press </> to select the frequency you want to use.

Choices: 35 to 250 (Hz), WIDE
Initial: 88 Hz

4 Adjust the volume of the subwoofer with the controls on the subwoofer so it matches that of the speaker you are comparing it to.



You can use the test tone not only for adjusting the subwoofer level, but also for checking the low-frequency characteristics of your listening room. Low-frequency sounds are especially affected by the listener's position, speaker placement, subwoofer polarity and other conditions.

■ Headphone tone control H>HP TONE CTRL

Use to adjust the amount of bass and treble output to your headphones.

Choices: -6 to +6 (dB)

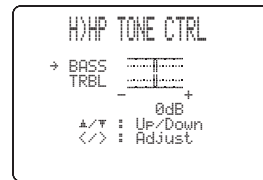

- Use BASS to adjust the headphone bass level.
- Use TRBL to adjust the headphone treble level.

■ Audio set I>AUDIO SET

Use to customize this unit's overall audio settings.



Mute MUTE

Use to adjust how much the mute function reduces the output volume.

Choices: **MUTE**, -20 dB

- Select "MUTE" to completely halt all output of sound.
- Select "-20 dB" to reduce the current volume by 20 dB.

Audio Delay AUDIO DELAY

Use to delay the sound output and synchronize it with the video image. This may be necessary when using certain LCD monitors or projectors.

Choices: **0** to 240 (ms)

Dialog lift DIALG. LIFT

Use to turn on/off the DIALG.LIFT parameter (see page 85). This parameter adjusts the height of the front and center channel sounds (dialog, vocals, etc.) by assigning some of the front and center channel elements to the presence speakers.

Choices: ON, **OFF**

- Select "ON" to turn on DIALG.LIFT effect.
- Select "OFF" to turn off DIALG.LIFT effect.

Note

DIALG.LIFT appears only when PRESENCE is set to "YES" (see page 31).

■ Presence/surround back channel select

J)PR/SBch SELECT

Surround back and presence speakers do not output sound simultaneously. You can select to prioritize either speaker set when playing sources that contain surround back channel signals using CINEMA DSP sound field programs.

Choices: PRch, SBch



- Select “PRch” to use presence speakers even when surround back channel signals are input. The signals for the surround back channel will be output from surround speakers.
- Select “SBch” to use surround back speakers when a surround back channel signal is detected in a CINEMA DSP program. Presence channel signals will be output from front speakers.

Using INPUT MENU

Use to reassign digital input/outputs, select the input mode or rename your inputs.



■ Input/output assignment

A) I/O ASSIGNMENT

You can assign jacks according to the component to be used if this unit's initial settings do not correspond to your needs. Change the following parameters to reassign the respective jacks and effectively connect more components.

Once the inputs have been reassigned, you can select the corresponding component by using INPUT on the front panel or the input selector buttons on the remote control.

Note

The default settings are displayed with parentheses on the OSD.

CMPNT-V IN for COMPONENT VIDEO INPUT jacks [A] and [B]

Choices: DVD, V-AUX, DVR/VCR 2, VCR 1, CBL/SAT, DTV, CD-R

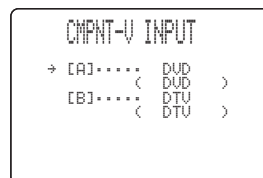

OPTICAL OUT for OPTICAL OUTPUT jacks (1) and (2)

Choices: MD/TAPE, CD-R, CD, PHONO, V-AUX, DVR/VCR 2, VCR 1, CBL/SAT, DTV, DVD

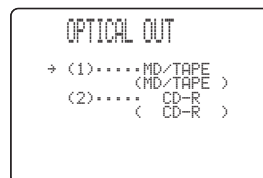

OPTICAL IN for OPTICAL INPUT jacks (3), (4), (5) and (6)

Choices: CD, PHONO, DVR/VCR 2, VCR 1, CBL/SAT, DTV, DVD, MD/TAPE, CD-R

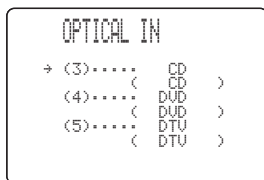

COAXIAL IN for COAXIAL INPUT jacks (7), (8) and (9)

Choices: CD, PHONO, V-AUX, DVR/VCR 2, VCR 1, CBL/SAT, DTV, DVD, MD/TAPE, CD-R

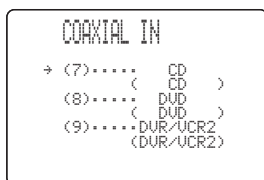

Notes

- You cannot select a specific item more than once for the same type of jack.
- When you connect a component to both the COAXIAL and OPTICAL jacks, priority is given to the input signals from the COAXIAL jack.

Input mode B) INPUT MODE

Use this feature to designate the input mode for sources connected to the DIGITAL INPUT jacks when you turn on this unit (see page 40 for details about the input mode).

Choices: **AUTO**, **LAST**



- Select "AUTO" to allow this unit to automatically detect the type of input signal and select the appropriate input mode.
- Select "LAST" to set this unit to automatically select the last input mode used for that source.

Note

The last setting for the EXTD. SUR button will not be recalled, even when "LAST" is selected.

Input rename C) INPUT RENAME

Use this feature to change the name of the inputs on the OSD and front panel display.



- Press an input selector button to select the input you want to change the name of.
- Set AMP/SOURCE/TV to AMP.
- Press </> to place the _ (under-bar) under the space or the character you want to edit.
- Press ▲ / ▼ to select the character you want to use and </> to move to the next one.
 - You can use up to 8 characters for each input.
 - Press ▼ to change the character in the following order, or press ▲ to go in the reverse order: A to Z, space, 0 to 9, space, a to z, space, #, *, +, etc.
- Repeat steps 1 through 4 to rename each input.
- Press > repeatedly to exit from INPUT RENAME.

■ **Multi Channel Input** D\MULTI CH INPUT

Use this feature to set the direction of the signals input into the center, subwoofer and surround channels when a source component is connected to the MULTI CH INPUT jacks. If you are inputting 8-channel signals from an external decoder, use this feature to select jacks for the additional front signals.

```
D\MULTI CH INPUT
→ *6CH 8CH
<FRNT/SB-> FRNT
CENTER -> CENTER
SWFR -> SWFR
SL/SR -> SL/SR
<---> SB
</> : Select
▲/▼ : UP/Down
```

6ch/8ch

This setting is used to select the number of channels input from an external decoder.

Choices: **6ch**, 8ch

Note

If ZONE2 AMP (page 64) is set to “ON”, no sound is output from the surround back speakers even if you select “8ch”. In this case select “6ch” and set the output setting of the external decoder to 6 channels.

FRNT

If you selected “8ch”, you can select analog audio jacks to which front signals from an external decoder will be input.

Choices: **DVD**, DTV, CBL/SAT, VCR 1, DVR/VCR 2, MD/TAPE, CD-R, CD, V-AUX

CENTER

Use to select where the signals input to the CENTER jack will be output.

Choices: **CENTER**, FRONT

- Select “CENTER” to output the signals from the center speaker.
- Select “FRONT” to output the signals from the front left and right speakers.

SWFR

Use to select where the signals input to the SUBWOOFER jack will be output.

Choices: **SWFR**, FRONT

- Select “SWFR” to output the signals from the subwoofer.
- Select “FRONT” to output the signals from the front left and right speakers.

SL/SR

Use to select where the signals input to the SURROUND jacks will be output.

Choices: **SL/SR**, FRONT

- Select “SL/SR” to output the signals from the surround speakers.
- Select “FRONT” to output the signals from the front left and right speakers.

Using OPTION MENU

```
4 OPTION MENU/2
→ A)DISPLAY SET
B)MEMORY GUARD
C)PARAM. INI
D)SP IMP. SET
▲/▼ : UP/Down
</> : Enter
```

■ **Display set** A)DISPLAY SET

```
A)DISPLAY SET
→ DIMMER.....0
OSD SHIFT.....0
GRAY BACK.....AUTO
V CONU.....ON
CMPNT OSD.....ON
▲/▼ : UP/Down
</> : Select
```

Dimmer DIMMER

Use to adjust the brightness of the front panel display.

Choices: -4 to **0**

OSD shift OSD SHIFT

Use to adjust the vertical position of the OSD.

Choices: +5 (downward) to -5 (upward)

- Press ▷ to lower the position of the OSD.
- Press ◁ to raise the position of the OSD.

Gray back GRAY BACK

Selecting “AUTO” for the on-screen display setting displays a gray background when there’s no video signal input.

If “OFF” is selected, information can only be displayed on the screen when a video signal is being input.

Choices: **AUTO**, OFF

Note

If GRAY BACK is set to “OFF”, information cannot be displayed when only component signals are being input.

Video conversion V>CONV.

Use this feature to turn on/off conversion of composite (VIDEO) signals to both S-video and component signals. This allows you to output converted video signals from the S VIDEO or COMPONENT VIDEO jacks when no S-video or component signals are input. This feature also converts S-video signals to component signals when no component signals are input.

Choices: **ON**, OFF

- Select “OFF” not to convert any signals.
- Select “ON” to convert composite signals to S-video and component signals, and to convert S-video signals to component signals.

Notes

- Converted video signals are only output to the MONITOR OUT jacks. When recording you must make the same type of video connections (composite or S-video) between each component.
- When converting composite video or S-video signals from a VCR to component video signals, the picture quality may suffer depending on your VCR.

Component OSD CMPNT OSD

Use this feature to turn on/off OSD output to the COMPONENT VIDEO MONITOR OUT jacks when using SET MENU, the test tone or the parameter functions.

Choices: **ON**, OFF

- Select “ON” to output the OSD signals from COMPONENT VIDEO MONITOR OUT jacks.
- Select “OFF” if you do not want to output the OSD signals from COMPONENT VIDEO MONITOR OUT jacks.

Note

SET MENU functions even when “OFF” is selected.

Memory guard B>MEMORY GUARD

Use this feature to prevent accidental changes to DSP program parameter values and other system settings.

Choices: **OFF**, ON



Select “ON” to protect:

- DSP program parameters
- All SET MENU items
- All speaker levels
- The on-screen display (OSD) mode

Note

When MEMORY GUARD is set to “ON”, you cannot use the test tone or select any other SET MENU items.

Parameter initialization C>PARAM. INI

Use this feature to initialize the parameters for each sound field program within a sound field program group. When you initialize a sound field program group, all of the parameter values within that group revert to their initial settings.

Press the corresponding numeric button for the sound field program that you want to initialize.

An asterisk (*) next to a program number means that the parameter values have been changed from their initial settings.

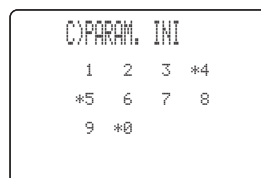
**Notes**

- You cannot automatically revert to the previous parameter settings once you initialize a sound field program group.
- You cannot separately initialize individual sound field programs.
- You cannot initialize any program groups when MEMORY GUARD is set to ON.

Speaker impedance setting**D>SP IMP.SET**

Use to select the impedance of your speakers.

Choices: 6ohms, **8ohms**



■ Zone set E)ZONE SET

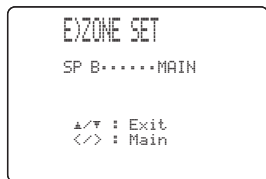

Speakers B SP B

Use to specify the location of speakers connected the SPEAKERS B terminals.

Choices: **MAIN**, ZONE B

- Select "MAIN" to turn on/off SPEAKERS A and B when the speakers connected to the SPEAKERS B terminals are set in the main room.
- Select "ZONE B" if the speakers connected to the SPEAKERS B terminals are set in another room. If SPEAKERS A is turned OFF and SPEAKERS B is turned ON, all the speakers including the subwoofer in the main room are muted and the unit outputs sound from SPEAKERS B only.

Notes

- If you select "ZONE B" and connect headphones to the PHONES jack on the unit, the sound is output from both headphones and SPEAKERS B.
- When a DSP program is selected, the unit automatically enters the Virtual CINEMA DSP mode.

■ Zone 2 set F)ZONE2 SET



Output volume OUTPUT VOL

Use to select how the volume control will operate with regard to the ZONE 2 OUTPUT jacks.

Choices: **VAR.**, FIX

- Select "VAR." to adjust the ZONE 2 OUTPUT volume simultaneously with VOL -/+ on the remote control.
- Select "FIX" to fix the ZONE 2 OUTPUT volume level to a standard line level.

Zone 2 amplifier ZONE2 AMP

Use to select how the ZONE 2 speakers will be amplified.

Choices: ON, **OFF**

- Select "OFF" if you do not use Zone 2 speakers or if you connect your Zone 2 speakers through an external amplifier connected to this unit's ZONE 2 OUTPUT jacks.
- Select "ON" to use this unit's internal amplifier if you connect your Zone 2 speakers directly to this unit's PRESENCE/ZONE 2 speaker terminals.

■ Zone 3 set G)ZONE3 SET

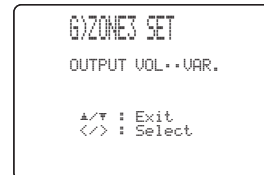

Output volume OUTPUT VOL

Use to select how the volume control will operate with regard to the ZONE 3 OUTPUT jacks.

Choices: **VAR.**, FIX

- Select "VAR." to adjust the ZONE 3 OUTPUT volume simultaneously with VOL -/+ on the remote control.
- Select "FIX" to fix the ZONE 3 OUTPUT volume level to a standard line level.

REMOTE CONTROL FEATURES

In addition to controlling this unit, the remote control can also operate other audio and video components made by YAMAHA and other manufacturers. To control these other components, you must set up the remote control with the appropriate remote control codes. This remote control also has a Learn feature which allows the remote to acquire functions from other remote controls equipped with an infrared remote control transmitter.

Control area

■ Controlling this unit

The shaded areas below can be used to control this unit after setting AMP/SOURCE/TV to AMP to activate the AMP mode.

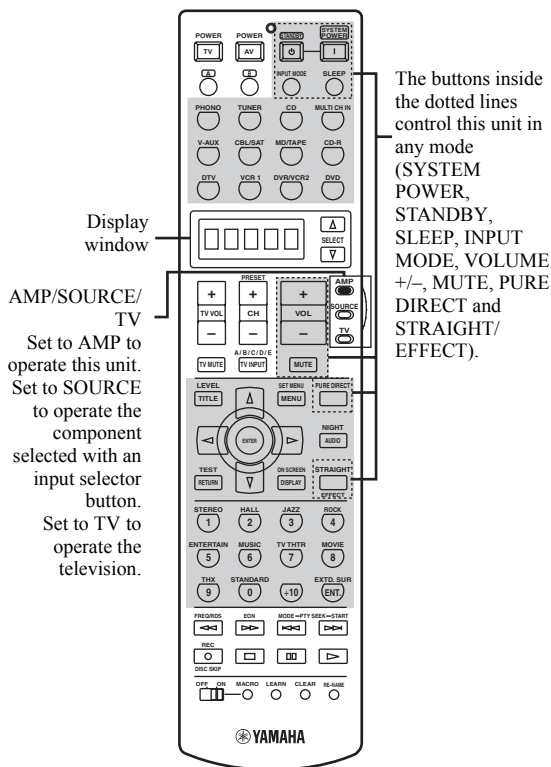

■ Controlling other components

The shaded areas below can be used to control other components. Each button has a different function depending on the selected components. Select the component you want to control by pressing an input selector button or SELECT Δ/∇ . The name of the selected component appears in the display window.

A/B buttons and the input selector buttons switch the function of the component control area below.
* Use the A/B buttons to control other components regardless of whether they are connected to this unit.
Factory setting:
A...LD player
B...Tape deck
SELECT Δ/∇ switches control to another component without changing the input source on this unit.

Component control area

You can control up to 14 different components by setting appropriate remote control codes (see page 76).

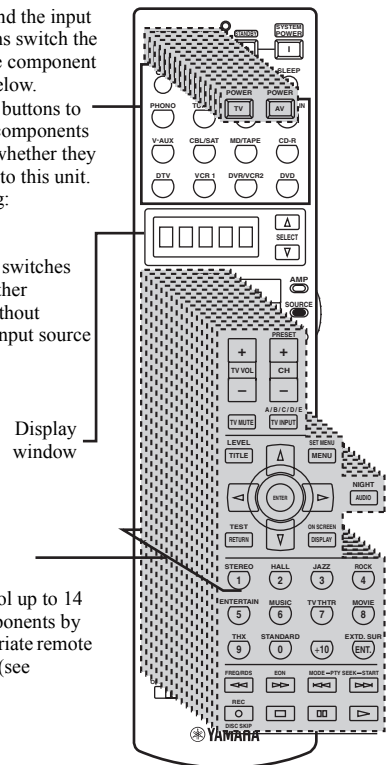

■ Controlling optional components (OPTN area)

OPTN is an additional component control area that can be programmed with remote control functions independently from any input source. This area is useful for programming commands that are to be used only as a part of a macro function or for components that do not have a valid remote control code.

To select the OPTN control area, press ∇ repeatedly until OPTN appears in the display window.

Notes

- You cannot set a remote control code for this area. See page 68 to program buttons operated within this component control area.
- The OPTN area cannot be used when AMP1Z or NO is selected in the amplifier library (see page 67).

Setting remote control codes

You can control other components by setting the appropriate remote control codes. Codes can be set up for each input area.

The following table shows the default component (Library: component category) and the remote control code for each input area.

Remote Control Code Default Settings

Input area	Library (Component category)	Default YAMAHA code*
A	LD	2200
B	TAPE	2700, (2701)
PHONO	TV	–
TUNER	TUNER	2600, (0203, 1203, 1358, 2601)
CD	CD	2300, (2301)
MULTI CH INPUT	DVD	2102, (0517, 0566, 0572, 2100, 2101)
V-AUX	VCR	–
CBL/SAT	CABLE	–
MD/TAPE	MD	2500, (2501, 2502)
CD-R	CD-R	2400
DTV	TV	–
VCR 1	VCR	–
DVR/VCR2	DVR	2807
DVD	DVD	2102, (0517, 0566, 0572, 2100, 2101)

* Additional YAMAHA codes available are given in parentheses.

Note

You may not be able to operate your YAMAHA component even if a YAMAHA remote control code is preset as listed above. In this case, try setting another YAMAHA remote control code.

1 Set AMP/SOURCE/TV to SOURCE.

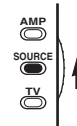

2 Press an input selector button to select the source component you want to set up.

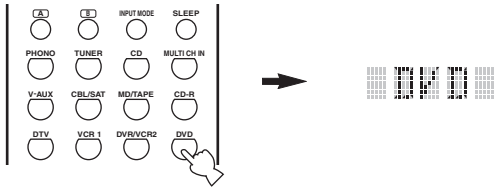

3 Press and hold LEARN for about 3 seconds using a ballpoint pen or similar object.

The library name (ex. "L: DVD") and the selected component name (ex. "DVD") appear alternately in the display window.



If you want to setup for another component, press the input selector button or SELECT Δ/∇ to select the component.

Notes

- Be sure to press and hold LEARN for at least 3 seconds, otherwise the learning process will start.
- If you do not complete each of the following steps within 30 seconds, the setting mode will be automatically canceled. In this case, press LEARN again.

If you want to change a library (component category), press \triangle/∇ . You can set a different type of component.

Library choices: L: DVD, L: DVR, L: LD, L: CD, L: CDR, L: MD, L: TAP (tape), L: TUN (tuner), L: AMP*, L: TV, L: CAB (cable), L: SAT (satellite), L: VCR

* The amplifier library (L: AMP) code is preset to "AMP1" (2000) in order to operate this unit. However, you can switch by entering one of the following five codes if necessary.

	Function	Code
AMP1	To operate this unit.	2000
AMP1Z	To operate ZONE 2 or ZONE 3 features.	2001
NO	To operate other manufacturers' receivers / amplifiers using this unit's remote control	2004

4 Press ENTER.

The four-digit code set for the selected component appears in the display window.

Note

"0000" appears in the display window if no code has been set.

5 Press the numeric buttons to enter the four-digit remote control code for the component you want to use.

For a complete list of available remote control codes, refer to "LIST OF REMOTE CONTROL CODES" at the end of this manual.

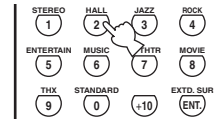

6 Press ENTER to set the number.

"OK" appears in the display window if setting was successful.

"NG" appears in the display window if the setting was unsuccessful. In this case, start over from step 3.



If you continuously want to set up another code for another component, press the input selector button or SELECT Δ/∇ to select the component, then repeat steps 4 through 6.

7 Press LEARN again to exit from the setup mode.



8 Press one of the buttons shaded below to see if you can control your component. If you can, the remote control code is correct.

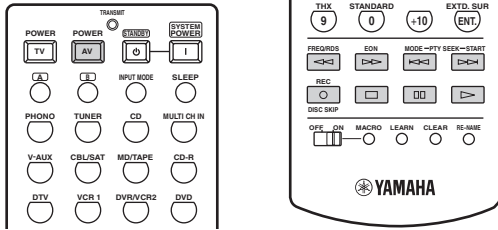

If the manufacturer of your component has more than one code, try each of them until you find the correct one.

Notes

- “ERROR” appears in the display window if you press a button not indicated in the respective step, or when you press more than one button simultaneously.
- The supplied remote control does not contain all possible codes for commercially available audio and video components (including YAMAHA components). If operation is not possible with any of the remote control codes, program the new remote control function using the Learn feature (see “Programming codes from other remote controls (Learn)”) or use the remote control supplied with the component.
- Function programmed using the learn feature take priority over remote control code functions.

Programming codes from other remote controls (Learn)

Use the Learn feature if you want to program functions not included in the basic operations covered by remote control codes, or an appropriate remote control code is not available. You can program any of the buttons available in the component control area (see page 65). The buttons can be programmed independently for each component.

Note

This remote control transmits infrared beams. If the other remote control also uses infrared beams, this remote control can learn most of its functions. However, you may not be able to program some special signals or extremely long transmissions. (Refer to the operating instructions for the other remote control.)

1 Set AMP/SOURCE/TV to SOURCE.

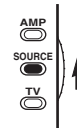

2 Press an input selector button to select a source component.

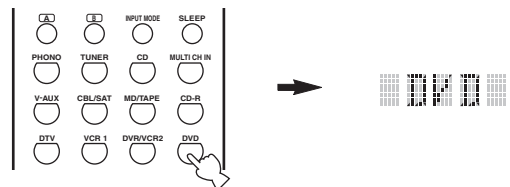

3 Place this remote control about 5 to 10 cm (2 to 4 in) apart from the other remote control on a flat surface so that their infrared transmitters are aimed at each other.

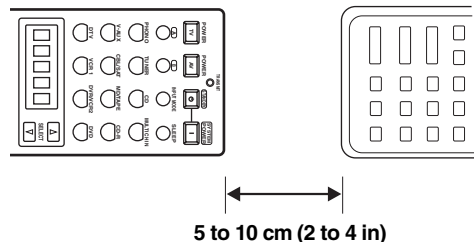

4 Press LEARN using a ballpoint pen or similar object.

“LEARN” and the selected component name (ex. “DVD”) appear alternately in the display window.

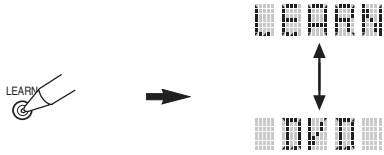

Notes

- Do not press and hold LEARN. If you hold it down for more than 3 seconds, the remote enters the remote control code setting mode.
- If you do not complete each of the following steps within 30 seconds, the learning mode will be automatically canceled. In this case, press LEARN again.

5 Press the button for which you want to program the new function.

“LEARN” appears in the display window.

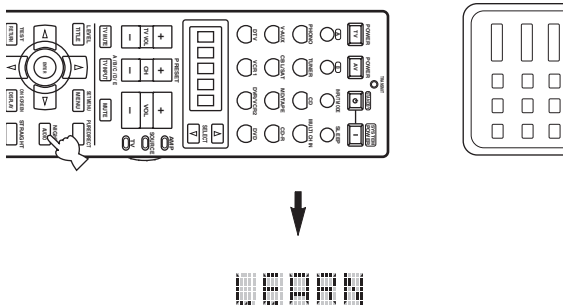

6 Press and hold the button you want to program on the other remote control until “OK” appears in the display window.

“NG” appears in the display window if learning was unsuccessful. In this case, start over from step 5.

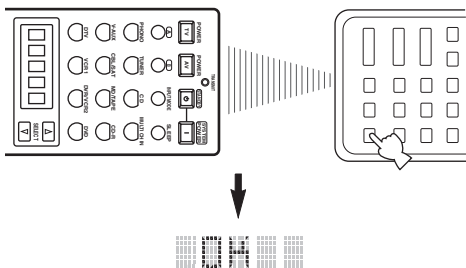

- If you want to program another function, repeat steps 5 and 6.
- If you continuously want to program another function for another component, press the input selector button or SELECT Δ/∇ to select the component, then repeat steps 3 through 6.

7 Press LEARN again to exit the learning mode.



Notes

- “ERROR” appears in the display window if you press a button not indicated in the respective step, or when you press more than one button simultaneously.
- This remote control can learn approximately 200 functions. However, depending on the signals learned, “FULL” may appear in the display before you program 200 functions. In this case, clear unnecessary programmed functions to make room for further learning.
- Learning may not be possible in the following cases:
 - When the batteries in the remote control for this unit or other components are weak.
 - When the distance between the two remote controls is too great or too small.
 - When the remote control infrared windows are not facing each other at the appropriate angle.
 - When the remote control is exposed to direct sunlight.
 - When the function to be programmed is continuous or uncommon.

Changing source names in the display window

You can change the name that appears in the display window on the remote control if you want to use a different name than the factory preset. This is useful when you have set the input selector to control a different component.

1 Set AMP/SOURCE/TV to AMP or SOURCE.

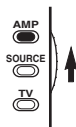

2 Press an input selector button to select the source component you want to rename.

The selected component name appears in the display window.



3 Press RE-NAME using a ballpoint pen or similar object.



Note

If you do not complete each of the following steps within 30 seconds, the renaming mode will be automatically canceled. In this case, press RE-NAME again.

4 Press Δ / ∇ to select and enter a character.

Pressing ∇ changes the character as follows: A to Z, 1 to 9, 0, + (plus), - (hyphen), ; (semicolon), / (slash), and space.

(Pressing Δ changes the characters in reverse order.)



5 Press \triangleleft / \triangleright to move the cursor to the next position.

6 Press ENTER to set the new name.

“OK” appears in the display window if renaming was successful.

“NG” appears in the display window if renaming was unsuccessful. In this case, start over from step 4.



If you continuously want to rename another component, press the input selector button or SELECT Δ / ∇ to select the component, then repeat steps 4 through 6.

7 Press RE-NAME again to exit the renaming mode.



Note

“ERROR” appears in the display window if you press a button not indicated in the respective step, or when you press more than one button simultaneously.

Using the Macro feature

The Macro feature makes it possible to perform a series of operations with the press of a single button. For example, when you want to play a CD, normally you would turn on the components, select the CD input, and press the play button to start playback. The Macro feature lets you perform all of these operations simply by pressing the CD macro button. The buttons listed as macro buttons below are factory set with macro programs. You can also program your own macros (see page 72).

Press a macro button



To automatically transmit these signals in order

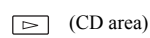

Macro buttons		First	Second	Third
			—	—
			(*4)	—
		—	—	—
		—	—	—
		—	—	—
		—	—	—
		—	PHONO	—
		—	TUNER (*3)	—
		—	CD	(CD area) (*2)
		—	MULTI CH IN	—
		—	V-AUX	—
		—	CBL/SAT	—
		—	MD/TAPE	(MD/TAPE area) (*2)
		—	CD-R	(CD-R area) (*2)
		—	DTV	—
		—	VCR 1	(VCR 1 area) (*2)
		—	DVR/VCR2	(DVR/VCR 2 area) (*2)
		—	DVD	(DVD area) (*2)



*1 You can turn on some components (including YAMAHA components) connected to this unit by connecting them to the AC OUTLET(S) on the rear panel of this unit. (Power control may not be synchronized with this unit depending on the component. For details, refer to the operating instructions for the connected component.)

*2 Playback can be started for any YAMAHA remote control-compatible MD recorder, CD player, CD recorder, DVD player, or DVD recorder. When using macros to operate other components, you will need to program the play button on the control area of that component (see page 68) or set a remote control code (see page 66).

*3 When TUNER is selected as the input source, this unit plays the last station received before the unit was set in the standby mode.

*4 TV POWER will operate your TV without switching the input if the remote control code for your TV is set up in the DTV or PHONO area. If the remote control code for your TV is set up in both the DTV and PHONO areas, priority is given to signal in the DTV area.

Macro operations

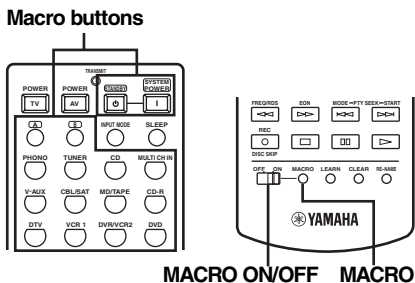

1 Set MACRO ON/OFF to ON.

2 Press a macro button.

Notes

- When you have finished using the Macro feature, set MACRO ON/OFF to OFF.
- While the remote is carrying out a Macro program, it will not accept any other button's function until the macro operation is complete (the transmission indicator stops flashing).
- Continue to aim the remote control at the component the macro is operating until the macro operation is complete.

Programming macro operations

You can program your own macros and use the macro feature to transmit several remote control commands in sequence at the press of a button. Be sure to set up remote control codes or perform learning operations before programming the macro. We do not recommend programming continuous operations such as volume control in a macro.

Notes

- The default macro is not cleared when a new macro is programmed for a button. The default macro can be used again when the programmed macro is cleared.
- It is not possible to add a new signal (macro step) to the default macro. Programming a macro changes all macro contents.

1 Set AMP/SOURCE/TV to AMP or SOURCE.

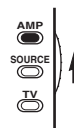

2 Press MACRO using a ballpoint pen or similar object.

“MCR ?” appears in the display window.



Note

If you do not complete each of the following steps within 30 seconds, the macro programming mode will be automatically canceled. In this case, press MACRO again.

3 Press the macro button you want to use to operate the macro.

The macro button name (ex. “M:DVD”) and the selected component name (ex. “DVD”) appear alternately in the display window.

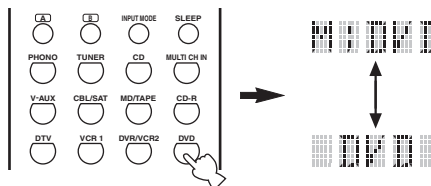

Note

“AGAIN” appears in the display window if you press a button other than a macro button.

4 Press the buttons for the functions you want to include in the macro operation in sequence.

You can set up to 10 steps (10 functions). After you have set 10 steps, "FULL" appears and the remote control automatically exits the macro mode.

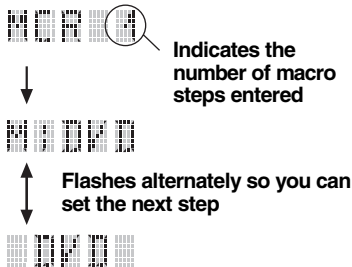
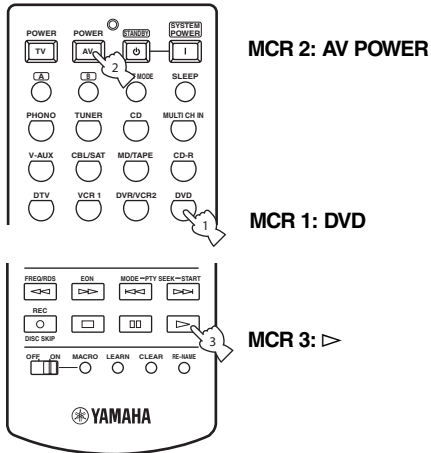

Note

- The macro operation may not work for a component which takes time to start up.
- To change the selected source component, press SELECT Δ / ∇ . Pressing the input selector buttons will program a macro step, whereas SELECT Δ / ∇ only changes the selected component and corresponding component control area.

5 Press MACRO again when the operation sequence you want to program is complete.

Note

"ERROR" appears in the display window if you press a button not indicated in the respective step, or if you press more than one button simultaneously.

Memory back-up

If the remote control is without batteries for more than 2 minutes, or if exhausted batteries remain in the remote control, the contents of the memory may be cleared. If the memory is cleared, insert new batteries, set up the remote control code(s) and program any acquired functions that may have been cleared.

Clearing function sets

You can clear all changes made in each function set, such as learned functions, renamed source names and setup remote control codes.

1 Set AMP/SOURCE/TV to AMP or SOURCE.

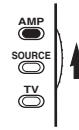

2 Press CLEAR by using a ballpoint pen or similar object.

"CLEAR" appears in the display window.



Note

If you do not complete each of the following steps within 30 seconds, the clearing mode will be automatically canceled. In this case, press CLEAR again.

3 Press Δ / ∇ to select the clear mode.

- L: DVD (L: name of a component)
Clears all learned functions in the respective component control area. Press an input selector button to select the component.
- L: AMP Clears all learned functions for this unit's control area.
- L: ALL Clears all learned functions.
- M: ALL Clears all programmed macros.
- RNAME Clears all renamed source names.
- FCTRY Clears all remote functions and returns the remote to the factory settings.

4 Press and hold CLEAR again for about 3 seconds.

"WAIT" appears in the display window. If clearing was successful, "C:OK" appears in the display window.



Once you have cleared a learned function for a button, the button reverts to the factory setting (or to the manufacturer setting, if you have set remote control codes).

Note

"L:ALL" and "FCTRY" may take about 30 seconds to complete.

5 Press CLEAR to exit from the clearing mode.



Notes

- “C:NG” appears in the display window if clearing was unsuccessful. In this case, start over from step 3.
- “ERROR” appears in the display window if you press a button not indicated in the respective step, or if you press more than one button simultaneously.

Clearing individual functions

■ Clearing a learned function

You can clear the function learned for a certain button in each control area.

1 Set AMP/SOURCE/TV to SOURCE.

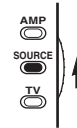

2 Press an input selector button to select the source component containing the function you want to clear.

The selected component name appears in the display window.

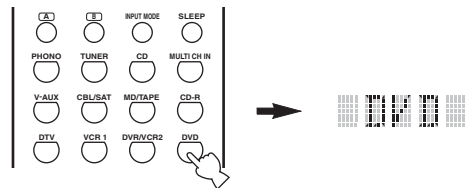

3 Press LEARN using a ballpoint pen or similar object.

“LEARN” and the selected component name (ex. “DVD”) appear alternately in the display window.

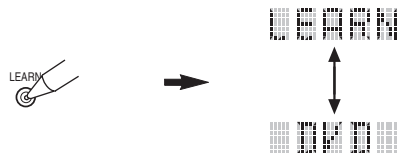

Notes

- Do not press and hold LEARN. If you hold it down for more than 3 seconds, the remote control enters the remote control code setting mode.
- If you do not complete each of the following steps within 30 seconds, the learning mode will be automatically canceled. In this case, press LEARN again.

4 Press and hold CLEAR using a ballpoint pen or similar object, then press the button you want to clear for about 3 seconds.

“C:OK” appears in the display window if clearing was successful.

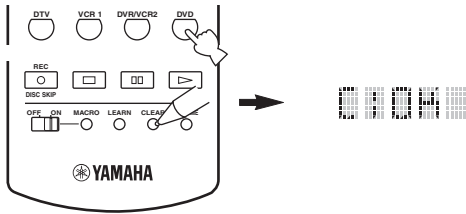

- If you continuously want to clear another function, repeat step 4.
- Once you clear a learned function, the button reverts to the factory setting (or to the manufacturer setting if you have set remote control codes).

5 Press CLEAR to exit the clearing mode.

The remote control returns to the learning mode.

6 Press LEARN again to exit.

Notes

- “C:NG” appears in the display window if clearing was unsuccessful. In this case, start over from step 4.
- “ERROR” appears in the display window if you press a button not indicated in the respective step, or if you press more than one button simultaneously.

Clearing a macro function

You can clear the function programmed for a certain macro button.

1 Set AMP/SOURCE/TV to AMP or SOURCE.

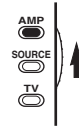

2 Press MACRO using a ballpoint pen or similar object.

“MCR ?” appears in the display window.



Note

If you do not complete each of the following steps within 30 seconds, the macro programming mode will be automatically canceled. In this case, press MACRO again.

3 Press and hold CLEAR using a ballpoint pen or similar object, then press the macro button you want to clear for about 3 seconds.

“C:OK” appears in the display window if clearing was successful.

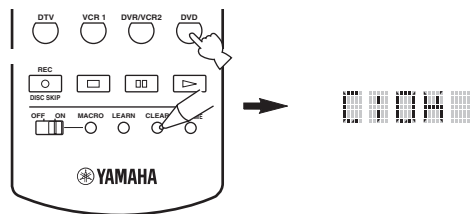

- If you continuously want to clear another function, repeat step 3.
- Once you clear a programmed function, the button reverts to the factory setting (or to the manufacturer setting if you have set remote control codes).

4 Press CLEAR to exit the clearing mode.

The remote control returns to the macro programming mode.

5 Press MACRO again to exit.

Notes

- “C:NG” appears in the display window if clearing was unsuccessful. In this case, start over from step 3.
- “ERROR” appears in the display window if you press a button not indicated in the respective step, or if you press more than one button simultaneously.

Controlling each component

Once you set the appropriate remote control codes, you can use this remote to control your other components. Note that some buttons may not correctly operate the selected component. Use the input selector buttons to select the component you want to operate. The remote control automatically switches to the appropriate control mode for that component.

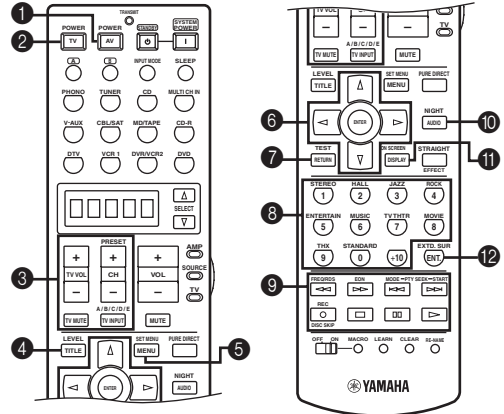

	DVD player/ DVD recorder	VCR	Cable TV/ Satellite tuner	TV	LD player	CD player	MD recorder/ CD recorder	Tape deck	Tuner
1 AV POWER	Power *1	Power *1	Power *1	VCR power *3	Power *1	Power *1	Power *1	Power *1	Power *1
2 TV POWER	TV power *2	TV power *2	TV power *2	Power *1	TV power *2	TV power *2	TV power *2	TV power *2	TV power *2
3 TV VOL +	TV volume + *2	TV volume + *2	TV volume + *2	Volume +	TV volume + *2	TV volume + *2	TV volume + *2	TV volume + *2	TV volume + *2
TV VOL -	TV volume - *2	TV volume - *2	TV volume - *2	Volume -	TV volume - *2	TV volume - *2	TV volume - *2	TV volume - *2	TV volume - *2
CH +	TV channel + *2	Channel +	Channel +	Channel +	TV channel + *2	TV channel + *2	TV channel + *2	TV channel + *2	PRESET +
CH -	TV channel - *2	Channel -	Channel -	Channel -	TV channel - *2	TV channel - *2	TV channel - *2	TV channel - *2	PRESET -
TV INPUT/ A/B/C/D/E	TV input *2	TV input *2	TV input *2	Input	TV input *2	TV input *2	TV input *2	Direction A/B	A/B/C/D/E
TV MUTE	TV mute *2	TV mute *2	TV mute *2	Mute	TV mute *2	TV mute *2	TV mute *2	TV mute *2	TV mute *2
4 TITLE	Title	Title	Title	Title					
5 MENU	Menu		Menu	Menu					
6 ENTER	Menu enter		Menu select	Menu select					
Δ	Menu up		Menu up	Menu up					
∇	Menu down		Menu down	Menu down					
◁	Menu left		Menu left	Menu left					
▷	Menu right		Menu right	Menu right					
7 RETURN	Return	Return	Return	Return					
8 1-9, 0, +10	Numeric buttons	Numeric buttons	Numeric buttons	Numeric buttons	Numeric buttons	Numeric buttons	Numeric buttons		Preset stations (1-8)
9 ◀◀ *4	Search backward	Search backward	VCR search backward *3	VCR search backward *3	Search backward	Search backward	Search backward	Search backward	
▶▶ *4	Search forward	Search forward	VCR search backward *3	VCR search backward *3	Search forward	Search forward	Search forward	Search forward	
⏮ *4	Skip backward				Chapter/Skip backward	Skip backward	Skip backward	Direction back	
⏭ *4	Skip forward				Chapter/Skip forward	Skip forward	Skip forward	Direction forward	
REC/ DISC SKIP	Disc skip (player) Rec (recorder)	Rec	VCR rec *3	VCR rec *3		Disc skip	Rec	Rec	
□	Stop	Stop	VCR stop *3	VCR stop *3	Stop	Stop	Stop	Stop	
⏸	Pause	Pause	VCR pause *3	VCR pause *3	Pause	Pause	Pause	Pause	
▷	Play	Play	VCR play *3	VCR play *3	Play	Play	Play	Play	
10 AUDIO	Audio				Audio				
11 DISPLAY	Display		Display	Display	Display	Display	Display		
12 ENTER	Title/Index	Enter	Enter/recall	Enter/ numeric button	Chapter/Time	Index	Index		

*1 This button functions only when the original remote control of the component has a POWER button.

*2 These buttons can operate your TV without switching the input if the remote control code is set in DTV or PHONO. When the remote control code for your TV is set up in both the DTV and PHONO areas, priority is given to the signal in the DTV area.

*3 These buttons can operate your VCR without switching the input to VCR 1 if the remote control code is set in VCR 1.

*4 For U.S.A. and Canada models, button functions printed above these buttons are not available. They function as described in the table only.

ZONE 2/ZONE 3

This unit allows you to configure a multi-room audio system. The Zone 2 and Zone 3 features enable you to set this unit to reproduce separate input sources in the main room, second room (Zone 2) and third room (Zone 3). You can control this unit from the second or third room using the supplied remote control.

Only analog signals are sent to the second and third rooms. Any source you want to listen to in the second or third room must be connected using the analog (AUDIO L/R) input jacks on this unit.

Zone 2/Zone 3 connections

You need the following additional equipment to use the multi-room functions of this unit:

- An infrared signal receiver in the second and/or third room.
- An infrared emitter in the main room. This emitter transmits the infrared signals from the remote control in the second and/or third room to the main room (to a CD player or DVD player, for example).
- An amplifier and speakers for the second and/or third room.

- ☀
- Since there are many possible ways to connect and use this unit in a multi-room configuration, we recommend that you consult with your nearest authorized YAMAHA dealer or service center for the Zone 2/Zone 3 connections that best meet your requirements.
 - Some YAMAHA models are able to connect directly to the CONTROL OUT jack on this unit. If you own these products, you may not need to use an infrared emitter. Up to six YAMAHA components can be connected as shown.

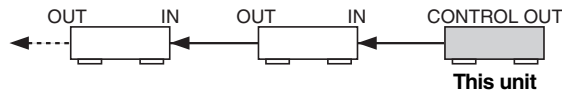

System configuration and connection example

Using external amplifiers

To use an external amplifier in Zone 2, set ZONE 2 AMP to “OFF” in SET MENU.

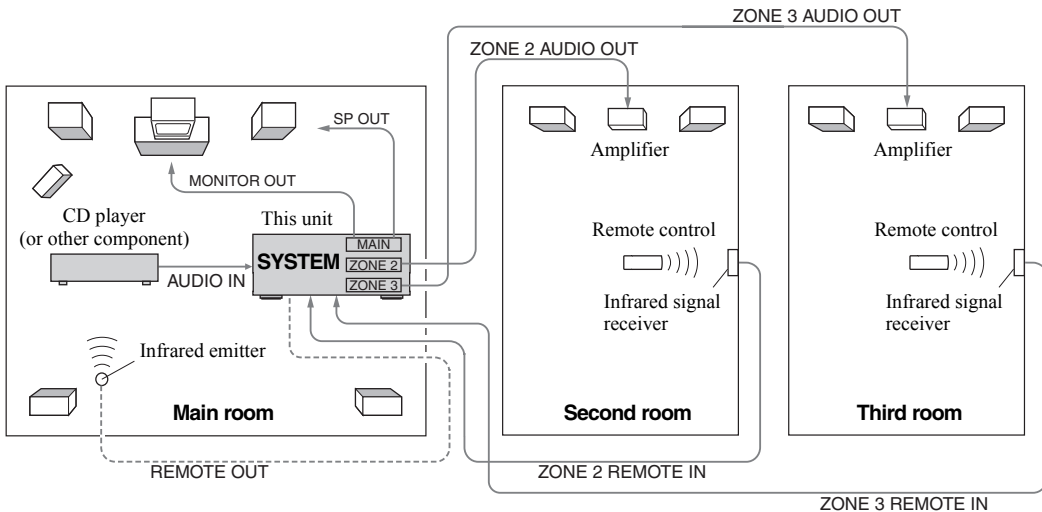

Notes

- When not using the main room, turn down the volume of this unit in the main room. Adjust the Zone 2/Zone 3 volume by using the amplifier in the second/third room.
- To avoid unexpected noise, DO NOT USE the Zone 2/Zone 3 feature with CDs encoded in DTS.

Using this unit's internal amplifier

To use this unit's internal amplifier, set ZONE 2 AMP to ON in SET MENU (see page 64).

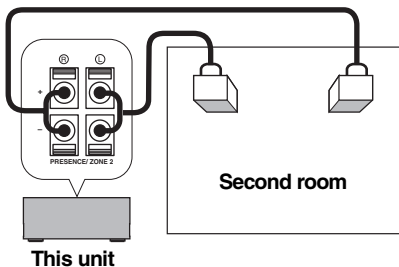

Remote controlling Zone 2/Zone 3

The supplied remote control can be used to control Zone 2/Zone 3. You can even select the input source and control components located in the main room directly from the second/third room regardless of the listening condition in the main room.

To enable Zone mode on the remote control

You will be able to switch the remote control mode from one room to another, and use the input selector, STANDBY, SYSTEM POWER, MUTE and VOLUME +/– to control the selected room.

1 Repeat steps 1 and 2 of the procedure in "Setting remote control codes" on page 66.

2 Press </> to select "L:AMP".



3 Press ENTER.
"2000" appears in the display window.

4 Enter the code number "2001".

5 Press ENTER to set the number.
"OK" appears in the display window if setting was successful.

6 Press LEARN to complete the Zone setup.
The remote control will be able to operate this unit from Zone 2 or Zone 3.



To control Zone 2/Zone 3

1 Press SELECT Δ repeatedly to display "ZONE 2" or "ZONE 3" in the display window.

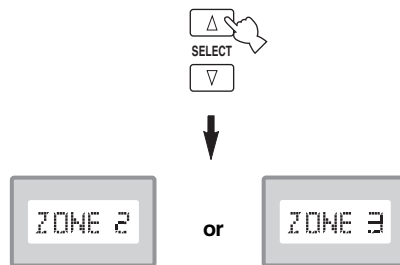

2 Press SYSTEM POWER to turn Zone 2 or Zone 3 power on.

3 Press an input selector button to select the input source you want to listen to in the second/third room.

The display window shows "2: name of selected input" or "3: name of selected input" if the remote control is in the Zone 2/Zone 3 mode.

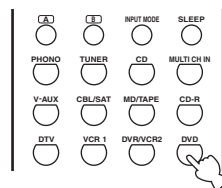

Note

Signals input to V-AUX and PHONO jacks cannot be sent to Zone 2/Zone 3.

4 You can control the unit from Zone 2 or Zone 3 by using the input selector, STANDBY, SYSTEM POWER, MUTE and VOLUME +/- buttons.

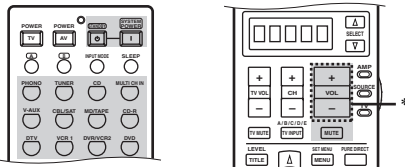

* VOLUME +/- can be used only when OUTPUT VOL is set to VAR. in SET MENU (see page 64).

5 Press SELECT Δ/∇ to exit from the Zone 2/ Zone 3 mode.

Notes

- The source in Zone 2 and the source available for recording are always the same.
- “ZONE2” or “ZONE3” will appear in the display window only when Δ is pressed, and “SYSTM” only when ∇ is pressed.

Turning this unit to either on or standby
SYSTEM POWER and STANDBY work differently depending on the selected mode that appears on the display window.

- When normal, Zone 2 or Zone 3 mode is selected, you can turn the main unit, Zone 2 or Zone 3 to on/standby individually.
- When System mode is selected, or when “AMP1” is selected as the amplifier library (L:AMP) code, you can turn the main unit, Zone 2 and Zone 3 to on/standby simultaneously.

	LCD display	SYSTEM POWER/STANDBY
Normal mode*	Name of component	Turns the main unit on/standby
Zone 2 mode	“ZONE2” or “2:name of component”	Turns Zone 2 to on/standby
Zone 3 mode	“ZONE3” or “3:name of component”	Turns Zone 3 to on/standby
System mode	“SYSTM”	Turns everything (the main unit, Zone 2, Zone 3) on/standby

* “MAIN” appears for a few seconds when SYSTEM POWER or STANDBY is pressed.

Special considerations for DTS software

The DTS signal is a digital bitstream. If you attempt to send the DTS signal to the second/third room you will only hear digital noise (that may damage your speakers). Thus, the following considerations and adjustments need to be made when playing DTS encoded discs.

For DVDs encoded with DTS

Only 2 channel analog audio signals may be sent to the second/third room.

Use the disc menu to set the DVD player’s mixed 2-channel left and right audio outputs to the PCM or Dolby Digital soundtrack.

For CDs encoded in DTS

To avoid unexpected noise, DO NOT USE the Zone 2/ Zone 3 feature with CDs encoded in DTS.

EDITING SOUND FIELD PARAMETERS

What is a sound field?

A significant factor that creates the rich, full tones of a live instrument are the multiple reflections from the walls of the room. In addition to making the sound “live”, these reflections enable us to tell where the player is situated, and the size and shape of the room in which we are sitting.

■ Elements of a sound field

In any environment, in addition to the direct sound coming straight to our ears from the player’s instrument, there are two distinct types of sound reflections that combine to make up the sound field:

Early reflections

Reflected sounds reach our ears extremely rapidly (50 ms – 100 ms after the direct sound), after reflecting from one surface only — for example, from the ceiling or a wall. Early reflections help add clarity to the direct sound.

Reverberations

These are caused by reflections from more than one surface — walls, ceiling, the back of the room — so numerous that they merge together to form a continuous sonic “afterglow”. They are non-directional, and lessen the clarity of the direct sound.

Direct sound, early reflections and subsequent reverberation taken together help us to determine the subjective size and shape of the room, and it is this information that the digital sound field processor reproduces in order to create sound fields.

If you could create the appropriate early reflections and subsequent reverberations in your listening room, you would be able to create your own listening environment. The acoustics in your room could be changed to those of a concert hall, a dance floor, or virtually any size room at all. This ability to create sound fields at will is exactly what YAMAHA has done with the digital sound field processor.

Changing parameter settings

You can enjoy good quality sound with the factory preset parameters. Although you do not have to change the initial settings, you can change some of the parameters to better suit the input source or your listening room.

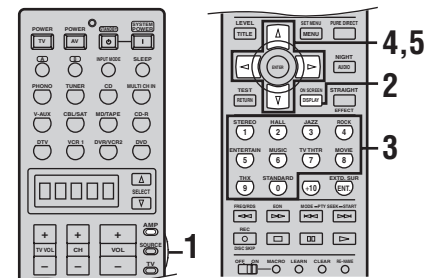

1 Set AMP/SOURCE/TV to AMP.

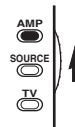

2 Turn on the video monitor and press ON SCREEN repeatedly to select the full display mode.



3 Select the sound field program you want to adjust.

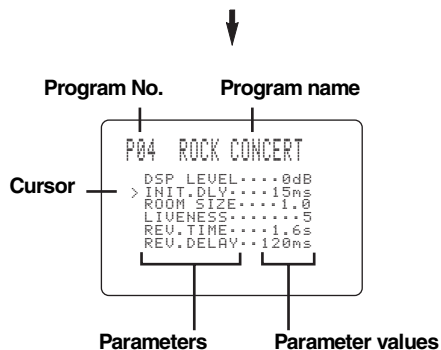
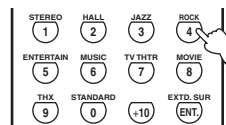

4 Press Δ / ∇ to select the parameters.

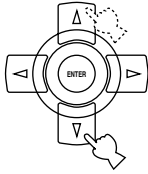

5 Press \triangleleft / \triangleright to change the parameter value.

When you set a parameter to a value other than the factory preset, an asterisk mark (*) appears by the parameter name on the video monitor.

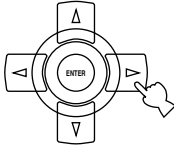

6 Repeat steps 3 through 5 as necessary to change other program parameters.

Notes

- The available parameters may be displayed on more than one OSD page for some of the programs. To scroll through pages, press Δ / ∇ .
- You cannot change parameter values when MEMORY GUARD is set to "ON". If you want to change the parameter values, set MEMORY GUARD to "OFF" (see page 63).

Memory back-up

The memory back-up circuit prevents the stored data from being lost even if this unit is set in the standby mode, the power cord is disconnected from the AC outlet, or the power supply is temporarily cut due to power failure. However, if the power is cut for more than one week, the parameter values will return to the factory settings. If this happens, edit the parameter value again.

■ Resetting parameters to the factory values

To reset a certain parameter

Select the parameter you want to reset, then press \triangleleft / \triangleright repeatedly until the asterisk mark (*) next to the parameter name disappears from the video monitor.

To reset all parameters

Use PARAM.INI (see page 63).

SOUND FIELD PARAMETER DESCRIPTIONS

You can adjust the values of certain digital sound field parameters so the sound fields are recreated accurately in your listening room. Not all of the following parameters are found in every program.

■ DSP LEVEL

Function: This parameter adjusts the level of all the DSP effect sounds within a narrow range.

Description: Depending on the acoustics of your listening room, you may want to increase or decrease the DSP effect level relative to the level of the direct sound.

Control range: -6 dB – +3 dB

■ INIT. DLY/P. INIT. DLY (Initial delay)

Function: This parameter changes the apparent distance the sound source is from the reflection face by adjusting the delay between the direct sound and the first reflection heard by the listener.

Description: The smaller the value, the closer the reflection face seems to the sound source. The larger the value, the farther it seems. For a small room, set to a small value. For a large room, set to a large value.

Control range: 1 – 99 msec

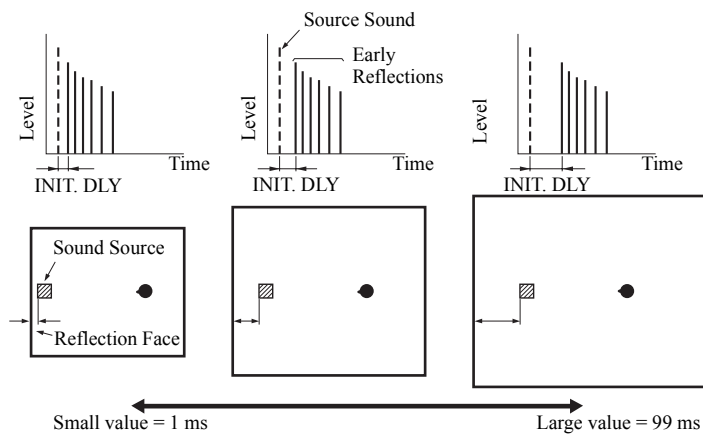

■ ROOM SIZE/P. ROOM SIZE (Room size)

Function: This parameter adjusts the apparent size of the surround sound field. The larger the value, the larger the surround sound field becomes.

Description: As the sound is repeatedly reflected around a room, the larger the hall is, the longer the time between the original reflected sound and the subsequent reflections. By controlling the time between the reflected sounds, you can change the apparent size of the virtual venue. Changing this parameter from one to two, doubles the apparent length of the room.

Control range: 0.1 – 2.0

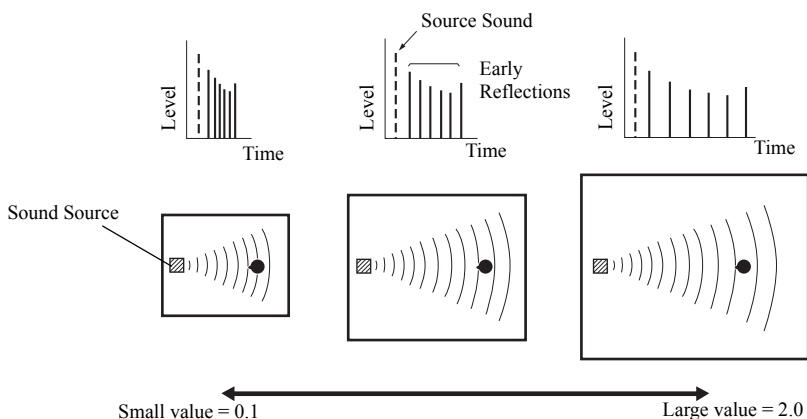

■ LIVENESS

Function: This parameter adjusts the reflectivity of the virtual walls in the hall by changing the rate at which the early reflections decay.

Description: The early reflections of a source sound decay much faster in a room with acoustically absorbent wall surfaces than in one which has highly reflective surfaces. A room with acoustically absorbent surfaces is referred to as “dead”, while a room with highly reflective surfaces is referred to as “live”. The LIVENESS parameter lets you adjust the early reflection decay rate, and thus the “liveness” of the room.

Control range: 0 – 10

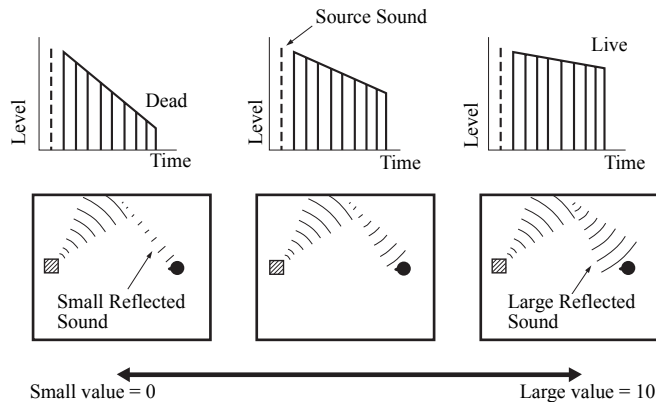

■ S. INIT. DLY (Surround initial delay)

Function: This parameter adjusts the delay between the direct sound and the first reflection on the surround side of the sound field. You can only adjust this parameter when at least two front channels and two surround channels are used.

Control Range: 1 – 49 msec

■ S. ROOM SIZE (Surround room size)

Function: This parameter adjusts the apparent size of the surround sound field.

Control Range: 0.1 – 2.0

■ S. LIVENESS (Surround liveness)

Function: This parameter adjusts the apparent reflectivity of the virtual walls in the surround sound field.

Control Range: 0 – 10

■ SB INI. DLY (Surround back initial delay)

Function: This parameter adjusts the delay between the direct sound and the first reflection in the surround back sound field.

Control Range: 1 – 49 msec

■ SB ROOM SIZE (Surround back room size)

Function: This parameter adjusts the apparent size of the surround back sound field.

Control Range: 0.1 – 2.0

■ SB LIVENESS (Surround back liveness)

Function: This parameter adjusts the apparent reflectivity of the virtual wall in the surround back sound field.

Control Range: 0 – 10

REV.TIME (Reverberation time)

Function: This parameter adjusts the amount of time it takes for the dense, subsequent reverberation sound to decay by 60 dB (at 1 kHz). This changes the apparent size of the acoustic environment over an extremely wide range.

Description: The longer the reverberation time, the more “live” the listening room environment seems. The shorter the reverberation time, the more “dead” the listening room environment seems.

Control Range: 1.0 – 5.0 sec

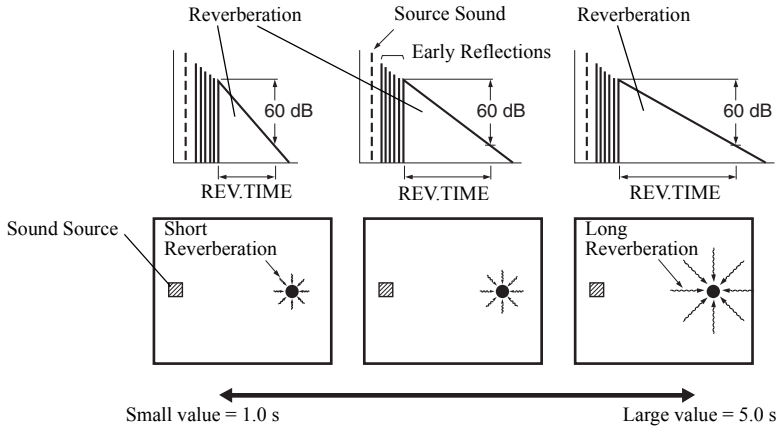

REV.DELAY (Reverberation delay)

Function: This parameter adjusts the time difference between the beginning of the direct sound and the beginning of the reverberation sound.

Description: The larger the value, the later the reverberation sound begins. A later reverberation sound makes you feel like you are in a larger acoustic environment.

Control Range: 0 – 250 msec

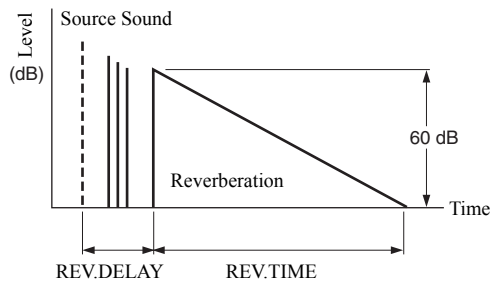

REV. LEVEL (Reverberation level)

Function: This parameter adjusts the volume of the reverberation sound.

Description: The larger the value, the stronger the reverberation becomes.

Control Range: 0 – 100%

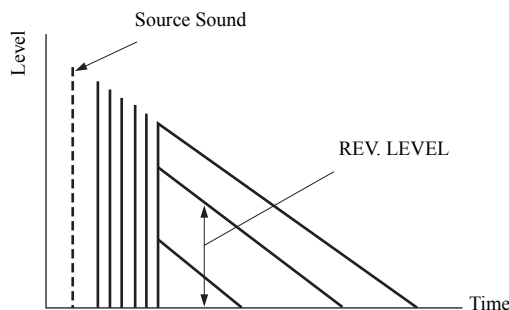

■ DIALG.LIFT (Dialog lift)

Function: This parameter adjusts the height of the front and center channel sounds by assigning some of the front and center channel elements to the presence speakers.

Description: The larger the parameter, the higher the position of the front and center channel sound.

Choices: 0/1/2/3/4/5, initial setting is 3.

For 7ch Stereo

Function: These parameters adjust the volume level for each channel in 7-channel stereo mode.

Control Range: 0 – 100%

■ CT LEVEL (Center level)

■ SL LEVEL (Surround left level)

■ SR LEVEL (Surround right level)

■ SB LEVEL (Surround back level)

■ PL LEVEL (Presence left level)

■ PR LEVEL (Presence right level)

For PRO LOGIC IIx Music and PRO LOGIC II Music

■ PANORAMA

Function: Extends the front stereo image to include the surround speakers for a wraparound effect.

Choices: OFF/ON, initial setting is OFF.

■ DIMENSION

Function: Gradually adjusts the sound field either towards the front or towards the rear.

Control range: –3 (towards the rear) to +3 (towards the front), initial setting is STD (standard).

■ CENTER WIDTH

Function: Adjusts the center image from all three front speakers to varying degrees. A larger value adjusts the center image towards the front left and right speakers.

Control range: 0 (center channel sound is output only from center speaker) to 7 (center channel sound is output only from front left and right speakers), initial setting is 3.

For PRO LOGIC IIx Music, Movie and Game

■ PLII/PLIIx (Pro Logic II/Pro Logic IIx)

Function: Switches the type of Pro Logic decoding to be used. PLII decoding creates 5.1-channel sound from 2-channel sources. PLIIx decoding creates 6.1/7.1-channel sound from 2-channel sources.

Choices: PLII, PLIIx

For DTS Neo:6 Music

■ C. IMAGE (Center image)

Function: This parameter adjusts the center image from all three front speakers to varying degrees.

Control range: 0 – 1.0

For THX Cinema

■ DEC (2ch Decoder Select)

Function: Selects the decoder used to playback 2-channel sources using THX Cinema.

Choices: PRO LOGIC / PLII Movie / Neo:6 Cinema

TROUBLESHOOTING

Refer to the chart below when this unit does not function properly. If the problem you are experiencing is not listed below or if the instruction below does not help, set this unit to the standby mode, disconnect the power cord, and contact the nearest authorized YAMAHA dealer or service center.

■ General

Problem	Cause	Remedy	Refer to page
This unit fails to turn on when STANDBY/ON (or SYSTEM POWER) is pressed, or enters in the standby mode soon after the power has been turned on.	The power cord is not connected or the plug is not completely inserted.	Connect the power cord firmly.	—
	The impedance setting is incorrect.	Set the impedance to match your speakers.	25
	The protection circuitry has been activated.	Make sure all speaker wire connections on this unit and on all speakers are secure and that the wire for each connection does not touch anything other than its respective connection.	13–16
	This unit has been exposed to a strong external electric shock (such as lightning and strong static electricity).	Set this unit in the standby mode, disconnect the power cord, plug it back in after 30 seconds, then use it normally.	—
On-screen display does not appear.	The setting for the on-screen display is set to “DISPLAY OFF”.	Select the full or short display mode.	50
	GRAY BACK in the SET MENU is set to “OFF”, and no video signal is currently being received.	Set GRAY BACK to “AUTO” to always show the OSD.	62
No sound	Incorrect input or output cable connections.	Connect the cables properly. If the problem persists, the cables may be defective.	18–21
	The optimizer microphone is connected.	Disconnect the optimizer microphone.	—
	The input mode is set to “DTS” or “ANALOG”.	Set the input mode to “AUTO”.	40
	No appropriate input source has been selected.	Select an appropriate input source with INPUT, MULTI CH INPUT or the input selector buttons.	33
	Speaker connections are not secure.	Secure the connections.	13
	The front speakers to be used have not been selected properly.	Select the front speakers with SPEAKERS A and/or B.	33
	The volume is turned down.	Turn up the volume.	—
	The sound is muted.	Press MUTE or any operation buttons of this unit to cancel a mute and adjust the volume.	35
	The input mode is set to “ANALOG” while playing a source encoded with a DTS signal.	Set the input mode to “AUTO” or “DTS”.	40
	The signals this unit cannot reproduce are being received from a source component e.g.: a CD-ROM.	Play a source whose signals this unit can reproduce.	—
No picture	The output and input for the picture are connected to different types of video jacks.	Turn on the video conversion function.	63

Problem	Cause	Remedy	Refer to page
The sound suddenly goes off.	The protection circuitry has been activated because of a short circuit, etc.	Check that the impedance selector setting is correct.	25
		Check the speaker wires are not touching each other and then turn this unit back on.	—
	The sleep timer has turned the unit off.	Turn on the power, and play the source again.	—
	The sound is muted.	Press MUTE to cancel a mute.	35
Only the speaker on one side can be heard.	Incorrect cable connections.	Connect the cables properly. If the problem persists, the cables may be defective.	13
	Incorrect balance settings in the SET MENU.	Adjust the SPEAKER LEVEL settings.	57
Only the center speaker outputs substantial sound.	When playing a monaural source with a CINEMA DSP program, the source signal is directed to the center channel, and the front and surround speakers output effect sounds.		
No sound from the effect speakers.	The sound field programs are turned off.	Press STRAIGHT/EFFECT to turn them on.	39
	You are using a source or program combination that does not output sound from all channels.	Try another sound field program.	34
No sound from the center speaker.	The output level of the center speaker is set to minimum.	Raise the level of the center speaker.	57
	CENTER SP in the SET MENU is set to "NONE".	Select the appropriate setting for the center speaker.	55
	One of the HiFi DSP programs (except for 7ch Stereo) has been selected.	Try another sound field program.	34
No sound from the surround speakers.	The output level of the surround speakers is set to minimum.	Raise the output level of the surround speakers.	57
	SURR L/R SP in the SET MENU is set to "NONE".	Select the appropriate setting for the surround left and right speakers.	56
	A monaural or stereo source is being played with STRAIGHT.	Press STRAIGHT/EFFECT to turn on the sound fields.	—
No sound from the surround back speakers.	Presence speakers are selected.	Select surround back speakers in PR/SBch SELECT.	60
	SURR L/R SP in the SET MENU is set to "NONE".	If the surround left and right speakers are set to "NONE", surround back speakers are automatically set to "NONE". Select the appropriate setting for the surround left and right speakers.	56
	SURR B L/R SP in the SET MENU is set to "NONE".	Select "SMLx1", "SMLx2", "LRGx1" or "LRGx2".	56
No sound from the subwoofer.	LFE/BASS OUT in the SET MENU is set to "FRNT" when a Dolby Digital or DTS signal is being played.	Select "SWFR" or "BOTH".	56
	LFE/BASS OUT in the SET MENU is set to "SWFR" or "FRNT" when a 2-channel source is being played.	Select "BOTH".	56
	The source does not contain low bass signals.		

Problem	Cause	Remedy	Refer to page
Dolby Digital or DTS sources cannot be played. (Dolby Digital or DTS indicator in the front panel display does not light up.)	The connected component is not set to output Dolby Digital or DTS digital signals.	Make an appropriate setting following the operations instructions for your component.	—
	The input mode is set to "ANALOG".	Set the input mode to "AUTO" or "DTS".	40
A "humming" sound can be heard.	Incorrect cable connections.	Firmly connect the audio plugs. If the problem persists, the cables may be defective.	—
	No connection from the turntable to the GND terminal.	Connect the grounding cord of your turntable to the GND terminal of this unit.	21
The volume level is low while playing a record.	The record is being played on a turntable with an MC cartridge.	The turntable should be connected to this unit through an MC-head amplifier.	21
The volume level cannot be increased, or the sound is distorted.	The component connected to the OUT (REC) jacks of this unit is turned off.	Turn on the power to the component.	—
The sound effect cannot be recorded.	It is not possible to record the sound effect with a recording component.		
A source cannot be recorded by a digital recording component connected to this DIGITAL OUTPUT jack.	The source component is not connected to this unit's DIGITAL INPUT jacks.	Connect the source component to the DIGITAL INPUT jacks.	18–21
	Some components cannot record Dolby Digital or DTS sources.		
A source cannot be recorded by an analog component connected to the AUDIO OUT jacks.	The source component is not connected to this unit's analog AUDIO IN jacks.	Connect the source component to the analog AUDIO IN jacks.	18–21
The sound field parameters and some other settings on this unit cannot be changed.	MEMORY GUARD in the SET MENU is set to "ON".	Select "OFF".	63
This unit does not operate properly.	The internal microcomputer has been frozen by an external electric shock (such as lightning or excessive static electricity) or by a power supply with low voltage.	Disconnect the AC power cord from the outlet and then plug it in again after about 30 seconds.	—
"CHECK SP WIRES" appears in the front panel display.	Speaker cables are short circuited.	Make sure all speaker cables are connected correctly.	13

Problem	Cause	Remedy	Refer to page
There is noise interference from digital or radio-frequency equipment, or this unit.	This unit is too close to the digital or radio-frequency equipment.	Move this unit further away from such equipment.	—
The picture is disturbed.	The video source uses scrambled or encoded signals to prevent dubbing.		
There is noise when the OSD is displayed.	The OSD may be disturbed when displaying OSD through component video connections.	Select OFF in CMPNT OSD.	63
This unit suddenly turns into the standby mode.	The internal temperature becomes too high and the overheat protection circuitry has been activated.	Wait for about 1 hour until this unit cools down and then turn it back on.	—

■ Tuner

Problem		Cause	Remedy	Refer to page
FM	FM stereo reception is noisy.	The characteristics of FM stereo broadcasts may cause this problem when the transmitter is too far away or the antenna input is poor.	Check the antenna connections. Try using a high-quality directional FM antenna.	23
			Use the manual tuning method.	41
	There is distortion, and clear reception cannot be obtained even with a good FM antenna.	There is multipath interference.	Adjust the antenna position to eliminate multipath interference.	—
	The desired station cannot be tuned in with the automatic tuning method.	The signal is too weak.	Use a high-quality directional FM antenna. Use the manual tuning method.	23 41
	Previously preset stations can no longer be tuned in.	This unit has been disconnected for a long period.	Preset the stations again.	42
AM	The desired station cannot be tuned in with the automatic tuning method.	The signal is weak or the antenna connections are loose.	Tighten the AM loop antenna connections and orient it for best reception. Use the manual tuning method.	— 41
	There are continuous crackling and hissing noises.	Noises result from lightning, fluorescent lamps, motors, thermostats and other electrical equipment.	Use an outdoor antenna and a ground wire. This will help somewhat, but it is difficult to eliminate all noise.	—
	There are buzzing and whining noises.	A TV set is being used nearby.	Move this unit away from the TV.	—

■ **Remote control**

Problem	Cause	Remedy	Refer to page
The remote control does not work nor function properly.	Wrong distance or angle.	The remote control will function within a maximum range of 6 m (20 ft) and no more than 30 degrees off-axis from the front panel.	8
	Direct sunlight or lighting (from an inverter type of fluorescent lamp, etc.) is striking the remote control sensor of this unit.	Reposition this unit.	—
	The batteries are weak.	Replace all batteries.	3
	AMP/SOURCE/TV is set incorrectly	Set AMP/SOURCE/TV correctly. When operating this unit, set it to the AMP position. When operating the component selected by the input selector button, set it to the SOURCE position. When operating the TV set in the DTV or PHONO area, set it to the TV position.	—
	The remote control code was not correctly set.	Set the remote control code correctly.	66
		Try setting another code of the same manufacturer.	66
Even if the remote control code is correctly set, there are some models that do not respond to the remote control.	Program the necessary functions independently into the programmable buttons using the Learn feature.	68	
The remote control does not “learn” new functions.	The batteries of this remote control and/or the other remote control are too weak.	Replace the batteries.	3
	The distance between the two remote controls is too much or too little.	Place the remote controls at the proper distance.	68
	The signal coding or modulation of the other remote control is not compatible with this remote control.	Learning is not possible.	—
	Memory capacity is full.	Delete other unnecessary functions to make room for the new functions.	73

GLOSSARY

Audio formats

■ Dolby Digital

Dolby Digital is a digital surround sound system that gives you completely independent multi-channel audio. It provides 5 full-range audio channels; 3 front channels (left, center, and right), and 2 surround stereo channels. An additional channel especially for bass effects, called LFE (low frequency effect) is also provided giving the system a total of 5.1-channels (LFE is counted as a 0.1 channel). By using 2-channel stereo for the surround speakers, more accurate moving sound effects and surround sound environment are possible than with Dolby Surround. The wide dynamic range (maximum to minimum volume) reproduced by the 5 full-range channels and the precise sound orientation generated using digital sound processing provide listeners with a previously unheard of excitement and realism.

■ Dolby Digital EX

Dolby Digital EX creates 6 full-bandwidth output channels from 5.1-channel sources. This is done by using a matrix decoder that derives 3 surround channels from the 2 in the original recording. For best results, Dolby Digital EX should be used with movie sound tracks recorded with Dolby Digital Surround EX. With this additional channel, you can experience more dynamic and realistic moving sound especially with scenes that have “flyover” and “fly-around” effects.

■ Dolby Pro Logic II

Dolby Pro Logic II is an improved technique used to decode vast numbers of existing Dolby Surround software. This new technology enables a 5-channel playback with 2 front left and right channels, 1 center channel, and 2 surround left and right channels (instead of only 1 surround channel for conventional Pro Logic technology). Music and Game modes are also available for 2-channel sources in addition to the Movie mode.

■ Dolby Pro Logic IIx

Dolby Pro Logic IIx is a new technology enabling 6.1 or 7.1 multi-channel playback from 2-channel or multi-channel sources. There is a Music mode for music, a Movie mode for movies and a Game mode for games.

■ Dolby Surround

Dolby Surround uses a 4 channel analog recording system to reproduce realistic and dynamic sound effects: 2 front left and right channels (stereo), a center channel for dialog (monaural), and a surround channel for special sound effects (monaural). The surround channel reproduces sound within a narrow frequency range.

Dolby Surround is widely used with nearly all video tapes and laser discs, and in many TV and cable broadcasts as well. The Dolby Pro Logic decoder built into this unit employs a digital signal processing system that automatically stabilizes the volume on each channel to enhance moving sound effects and directionality.

■ DTS 96/24

DTS 96/24 offers an unprecedented level of audio quality for multi-channel sound on DVD-Video, and is fully backward-compatible with all DTS decoders. “96” refers to a 96 kHz sampling rate (compared to the typical 48 kHz sampling rate). “24” refers to 24-bit word length. DTS 96/24 offers sound quality transparent to the original 96/24 master, and 96/24 5.1-channel sound with full-quality full-motion video for music programs and motion picture soundtracks on DVD-video.

■ DTS (Digital Theater Systems) Digital Surround

DTS digital surround was developed to replace the analog soundtracks of movies with a 6-channel digital sound track, and is now rapidly gaining popularity in movie theaters around the world. Digital Theater Systems Inc. has developed a home theater system so that you can enjoy the depth of sound and natural spatial representation of DTS digital surround in your home. This system produces practically distortion-free 6-channel sound (technically, left, right and center channels, 2 surround channels, plus an LFE 0.1 channel as a subwoofer, for a total of 5.1-channels). This unit incorporates a DTS-ES decoder that enables 6.1-channel reproduction by adding a surround back channel to the existing 5.1-channel format.

■ Neo:6

Neo:6 decodes conventional 2-channel sources for 6 channel playback by. It enables playback with the full-range channels with higher separation comparable to digital discrete signal playback. Two modes are available; “Music mode” for playing music sources and “Cinema mode” for movies.

■ PCM (Linear PCM)

Linear PCM is a signal format under which an analog audio signal is digitized, recorded and transmitted without using any compression. This is used as a method of recording CDs and DVD audio. The PCM system uses a technique for sampling the size of the analog signal per very small unit of time. Standing for “pulse code modulation”, the analog signal is encoded as pulses and then modulated for recording.

Sound field programs

■ CINEMA DSP

Since the Dolby Surround and DTS systems were originally designed for use in movie theaters, their effect is best felt in a theater having many speakers and designed for acoustic effects. Since home conditions, such as room size, wall material, number of speakers, and so on, can differ so widely, it's inevitable that there are differences in the sound heard. Based on a wealth of actually measured data, YAMAHA CINEMA DSP uses YAMAHA original sound field technology to combine Dolby Pro Logic, Dolby Digital and DTS systems to provide the visual and audio experience of a movie theater in the listening room of your own home.

■ SILENT CINEMA

YAMAHA has developed a natural, realistic sound effect DSP algorithm for headphones. Parameters for headphones have been set for each sound field so that accurate representations of all the sound field programs can be enjoyed on headphones.

■ Virtual CINEMA DSP

YAMAHA has developed a Virtual CINEMA DSP algorithm that allows you to enjoy DSP sound field surround effects without any surround speakers by using virtual surround speakers. It is even possible to enjoy Virtual CINEMA DSP using a minimal two-speaker system that does not include a center speaker.

Audio information

■ ITU-R

ITU-R is the radio communication sector of the ITU (International Telecommunication Union). ITU-R recommends a standard speaker placement which is used in many critical listening rooms, such as mastering studios.

■ LFE 0.1 channel

This channel is for the reproduction of low bass signals. The frequency range for this channel is 20 Hz to 120 Hz. This channel is counted as 0.1 because it only enforces a low frequency range compared to the full-range reproduced by the other 5/6 channels in Dolby Digital or DTS 5.1/6.1-channel systems.

■ Sampling frequency and number of quantized bits

When digitizing an analog audio signal, the number of times the signal is sampled per second is called the sampling frequency, while the degree of fineness when converting the sound level into a numeric value is called the number of quantized bits.

The range of rates that can be played back is determined based on the sampling rate, while the dynamic range representing the sound level difference is determined by the number of quantized bits. In principle, the higher the sampling frequency, the wider the range of frequencies that can be played back, and the higher the number of quantized bits, the more finely the sound level can be reproduced.

■ THX Cinema processing

THX is an exclusive set of standards and technologies established by the world-renowned film production company, Lucasfilm Ltd. THX grew from George Lucas' personal desire to make your experience of the film soundtrack, in both movie theatres and in your home theatre, as faithful as possible to what the director intended.

Movie soundtracks are mixed in special movie theatres called dubbing stages and are designed to be played back in movie theatres with similar equipment and conditions. This same soundtrack is then transferred directly onto Laserdisc, VHS tape, DVD, etc., and is not changed for playback in a small home theatre environment.

THX engineers developed patented technologies to accurately translate the sound from the movie theatre environment into the home, correcting the tonal and spatial errors that occur. On this product, when the THX indicator is on, THX features are automatically added in Cinema modes (e.g. THX Cinema, THX Surround EX).

Adaptive decorrelation

In a movie theatre, a large number of surround speakers help create an enveloping surround sound experience, but in a home theatre there are usually only two speakers. This can make the surround speakers sound like headphones that lack spaciousness and envelopment. The surround sounds will also collapse into the closest speaker as you move away from the middle seating position. Adaptive decorrelation slightly changes one surround channel's time and phase relationship with respect to the other surround channel. This expands the listening position and creates – with only two speakers – the same spacious surround experience as in a movie theatre.

Re-equalization

The tonal balance of a film soundtrack will be excessively bright and harsh when played back over audio equipment in the home because film soundtracks were designed to be played back in large movie theatres using very different professional equipment. Re-equalization restores the correct tonal balance for watching a movie soundtrack in a small home environment.

Timbre matching

The human ear changes our perception of sound depending on the direction from which it is coming. In a movie theatre, there is an array of surround speakers so that the surround information is all around you. In a home theatre, you use only two speakers located to the side of your head. The timbre matching feature filters the information going to the surround speakers so that they more closely match the tonal characteristics of the sound coming from the front speakers. This ensures seamless panning between the front and surround speakers.

■ THX Select

Before any home theatre component can be THX Select certified, it must incorporate pass a rigorous series of quality and performance tests. Only then can a product feature the THX Select logo, which is your guarantee that the Home Theatre products you purchase will give you superb performance for many years to come. THX Select requirements cover every aspect of the product including power amplifier and pre-amplifier performance and operation, and hundreds of other parameters in both the digital and analog domain.

■ THX Surround EX

THX Surround EX - Dolby Digital Surround EX is a joint development of Dolby Laboratories and the THX Ltd. In a movie theater, film soundtracks that have been encoded with Dolby Digital Surround EX technology are able to reproduce an extra channel which has been added during the mixing of the program. This channel, called Surround Back, places sounds behind the listener in addition to the currently available front left, front center, front right, surround right, surround left and subwoofer channels. This additional channel provides the opportunity for more detailed imaging behind the listener and brings more depth, spacious ambience and sound localization than ever before.

Movies that were created using the Dolby Digital Surround EX technology, when released into the home consumer market may exhibit wording to that effect on the packaging. A list of movies created using this technology can be found on the Dolby web site at www.dolby.com. A list of available DVD software titles encoded with this technology can be found at www.thx.com.

Only receiver and controller products bearing the THX Surround EX logo, when in the THX Surround EX mode, faithfully reproduce this new technology in the home. This product may also engage the THX Surround EX mode during the playback of 5.1 channel material that is not Dolby Digital Surround EX encoded. In such cases the information delivered to the Surround Back channel will be program dependent and may or may not be pleasing depending on the particular soundtrack and the tastes of the individual listener.

Video signal information

■ Component video signal

With the component video signal system, the video signal is separated into the Y signal for the luminance and the P_B and P_R signals for the chrominance. Color can be reproduced more faithfully with this system because each of these signals is independent. The component signal is also called the "color difference signal" because the luminance signal is subtracted from the color signal. A monitor with component input jacks is required in order to use the component signal for output.

■ Composite video signal

With the composite video signal system, the video signal is composed of three basic elements of a video picture; color, brightness and synchronization data. A composite video jack on a video component transmits these three elements combined.

■ S-video signal

With the S-video signal system, the video signal normally transmitted using a pin cable is separated and transmitted as the Y signal for the luminance and the C signal for the chrominance through the S-video cable. Using the S VIDEO jack eliminates video signal transmission loss and allows recording and playback of even more beautiful images.

SPECIFICATIONS

AUDIO SECTION

- Minimum RMS Output Power for Front, Center, Surround, Surround back
 - 20 Hz to 20 kHz, 0.04% THD, 8 Ω 120 W
 - 1 kHz, 0.7% THD, 8 Ω 140 W
- Dynamic Power (IHF)
 - 8/6/4/2 Ω 155/195/250/330 W
- Damping Factor (IHF)
 - 20 Hz to 20 kHz, 8 Ω 140 or more
- Frequency Response
 - CD to Front L/R 10 Hz to 100 kHz, -3 dB
- Total Harmonic Distortion
 - PHONO to REC OUT (20 Hz to 20 kHz, 1 V) 0.02%
 - CD, etc. to Front L/R (20 Hz to 20 kHz, 60 W, 8 Ω) 0.04%
- Signal to Noise Ratio (IHF-A Network)
 - PHONO (5 mV) to Front L/R 86 dB
 - CD (250 mV) to Front L/R, Effect Off 100 dB
- Residual Noise (IHF-A Network)
 - Front L/R 150 μ V or less
- Channel Separation (1 kHz/10 kHz)
 - PHONO (terminated) to Front L/R 60 dB/55 dB
 - CD (5.1 k Ω terminated) to Front L/R 60 dB/45 dB
- Tone Control (Front L/R)
 - BASS Boost/Cut \pm 6 dB/50 Hz
 - BASS Turnover Frequency 350 Hz
 - TREBLE Boost/Cut \pm 6 dB/20 kHz
 - TREBLE Turnover Frequency 3.5 kHz
- Phones Output 150 mV/100 Ω
- Input Sensitivity/Input Impedance
 - PHONO 3.5 mV/47 k Ω
 - CD, etc. 200 mV/47 k Ω
 - MULTI CH INPUT 200 mV/47 k Ω
- Output Level/Output Impedance
 - REC OUT 200 mV/1.2 k Ω
 - PRE OUT 1.0 V/500 Ω
 - SUBWOOFER 2.0 V/500 Ω
 - ZONE 2 OUTPUT 1.0 V/1.2 k Ω
 - ZONE 3 OUTPUT 1.0 V/1.2 k Ω

VIDEO SECTION

- Video Signal Type NTSC
- Signal to Noise Ratio 60 dB
- Frequency Response (MONITOR OUT)
 - Composite, S-video 5 Hz to 10 MHz, -3 dB
 - Component 5 Hz to 60 MHz, -3 dB

FM SECTION

- Tuning Range 87.5 to 107.9 MHz
- Usable Sensitivity (IHF) 1.0 μ V (11.2 dBf)
- Signal to Noise Ratio (IHF)
 - Mono/Stereo 76 dB/70 dB
- Harmonic Distortion (1 kHz)
 - Mono/Stereo 0.2%/0.3%
- Stereo Separation (1 kHz) 42 dB
- Frequency Response 20 Hz to 15 kHz +0.5, -2 dB

AM SECTION

- Tuning Range 530 to 1710 kHz
- Usable Sensitivity 300 μ V/m

GENERAL

- Power Supply AC 120 V/60 Hz
- Power Consumption 500 W/630 VA
- Standby Power Consumption 0.5 W or less
- AC Outlets 2 (Total 100 W/0.8 A maximum)
- Dimensions (W x H x D) 435 x 171 x 424 mm
(17-1/8" x 6-3/4" x 16-11/16")
- Weight 15.0 kg (33.1 lbs)

LIST OF REMOTE CONTROL CODES

AMPLIFIER

AMSTRAD	0105
ARCAM	0296
AUDIOLAB	0296
CARVER	0296
GE	0105
GENEXXA	0422
GRUNDIG	0296
HARMAN/KARDON	0919
JVC	0358
LEFT COAST	0919
LINN	0296
MAGNAVOX	0296
MARANTZ	0296, 0919
MICROMEGA	0296
MYRYAD	0296
OPTIMUS	0422
PANASONIC	0335
PHILIPS	0296, 0919
PIONEER	0040
POLK AUDIO	0296, 0919
REALISTIC	0422
REVOX	0296
SONY	0247
SOUNDESIGN	0105
TECHNICS	0335
THORENS	0296
VICTOR	0358
WARDS	0040, 0105
YAMAHA	0381

CABLE

ABC	0030, 0035
AMERICAST	0926
BELL SOUTH	0926
BIRMINGHAM CABLE COMMUNICATIONS	0303
BRITISH TELECOM	0030
CABLE & WIRELESS	1095
DAERYUNG	0035, 0504, 0904, 1904
DIRECTOR	0503
FILMNET	0470
GENERAL INSTRUMENT	0030, 0303, 0503, 0837,
GOLDSTAR	0171
HAMLIN	0036, 0300
JERROLD	0030, 0303, 0503, 0837
LG	0171
MNET	0470
MEMOREX	0027
MOTOROLA	0303, 0503, 0837, 1133
NTL	1095
NOOS	0844
ONO	1095
PVP STEREO VISUAL MATRIX	0030
PACE	0264, 1087, 1095
PANASONIC	0027, 0035, 0134
PARAGON	0027
PHILIPS	0332, 0344
PIONEER	0171, 0560, 0904, 1904

PULSAR	0027
QUASAR	0027
REGAL	0300, 0306
RUNCO	0027
SAGEM	0844
SAMSUNG	0027, 0171
SCIENTIFIC ATLANTA	0035, 0504, 0904, 1904
SONY	1033
STARCOM	0030
SUPERCABLE	0303
TS	0030
TELE+1	0470
TELEWEST	1095
TORX	0030
TOSHIBA	0027
TRANS PX	0303
UNITED CABLE	0030
ZENITH	0027, 0552, 0926

CD PLAYER

AIWA	0184
ARCAM	0184
AUDIO RESEARCH	0184
AUDIO TON	0184
AUDIOLAB	0184
AUDIOMECA	0184
CAIRN	0184
CALIFORNIA AUDIO LABS	0056
CARVER	0184, 0206
CYRUS	0184
DKK	0027
DMX ELECTRONICS	0184
DENON	0900
DYNAMIC BASS	0206
EMERSON	0332
FISHER	0206
GENEXXA	0059, 0332
GOODMANS	0332
GRUNDIG	0184
HARMAN/KARDON	0184, 0200
HITACHI	0059
JVC	0099
KENWOOD	0055, 0064
KRELL	0184
LXI	0332
LINN	0184
MCS	0056
MAGNAVOX	0184, 0332
MARANTZ	0056, 0184
MATSUI	0184
MEMOREX	0332
MERIDIAN	0184
MICROMEGA	0184
MIRO	0027
MISSION	0184
MYRYAD	0184
NAD	0027
NSM	0184
NAIM	0184
OPTIMUS	0027, 0059, 0064, 0206, 0332
PANASONIC	0056
PHILIPS	0184
PIONEER	0059, 0332
POLK AUDIO	0184

PROTON	0184
QED	0184
QUAD	0184
QUASAR	0056
RCA	0059, 0206, 0332
REALISTIC	0206
REVOX	0184
ROTEL	0184
SAE	0184
SANSUI	0184, 0332
SANYO	0206
SCOTT	0332
SEARS	0332
SHARP	0064
SIMAUDIO	0184
SONIC FRONTIERS	0184
SONY	0027
SYMPHONIC	0332
TAG MCLAREN	0184
TANDY	0059
TECHNICS	0056
THORENS	0184
THULE	0184
UNIVERSUM	0184
VICTOR	0099
WARDS	0184
YAMAHA	2300, 2301

CD RECORDER

KENWOOD	0653
MARANTZ	0653
PHILIPS	0653
YAMAHA	2400

DVD PLAYER

ACOUSTIC SOLUTIONS	0757
ALBA	0744
AMSTRAD	0740
APEX DIGITAL	0699, 0744, 0782, 0821, 0823, 0857, 1127
BLAUPUNKT	0744
BLUE PARADE	0598
BUSH	0740
CENTREX	0699
CLATRONIC	0815
CYBERHOME	0741
DVD2000	0548
DAEWOO	0811, 0797
DANSAI	0797
DECCA	0797
DENON	0517
DIAMOND	0795
DIGITREX	0699
EMERSON	0618
ENTERPRISE	0618
FISHER	0697
GE	0549, 0744
GO VIDEO	0742
GOLDSTAR	0768
GRADIENTE	0678
GREENHILL	0744
GRUNDIG	0566
HITACHI	0600, 0691
HITEKER	0699
JVC	0585, 0650
KLH	0744
KENWOOD	0517, 0561

KOSS	0678
LG	0768
LIMIT	0795
MAGNAVOX	0530, 0702
MARANTZ	0566
MEMOREX	0858
MICO	0750
MICROSOFT	0549
MINTEK	0744
MITSUBISHI	0548
MUSTEK	0757
NESA	0744
ONKYO	0530
ORITRON	0678
PALSONIC	0699
PANASONIC	0517, 0659, 1389
PHILIPS	0530, 0566, 0673, 0881
PIONEER	0552, 0598, 0658, 0659
POLK AUDIO	0566
PROSCAN	0549
QWESTAR	0678
RCA	0549, 0598, 0744
ROTEL	0650
SM ELECTRONIC	0757
SAMSUNG	0600
SANYO	0697
SHARP	0657
SHERWOOD	0797
SHINSONIC	0560
SLIM ART	0811
SONY	0560, 0891
SYLVANIA	0702
TATUNG	0797
TEAC	0598, 0744
TECHNICS	0517
THETA DIGITAL	0598
THOMSON	0549
TOSHIBA	0530
URBAN CONCEPTS	0530
XBOX	0549
YAMAHA	0517, 0566, 0572, 2100, 2101, 2102
ZENITH	0530, 0618, 0768
ZEUS	0811

DVD RECORDER

PANASONIC	2800, 2801, 2802
PHILIPS	2808
PIONEER	2804, 2805, 2806
TOSHIBA	2803
YAMAHA	2807

LD PLAYER

CARVER	0091
DENON	0086
MARANTZ	0091
MITSUBISHI	0086
NAD	0086
NAGSMI	0086
OPTIMUS	0086
PHILIPS	0091
PIONEER	0086
SALORA	0091
SONY	0228
TELEFUNKEN	0086
YAMAHA	2200

MD RECORDER

KENWOOD	0708
ONKYO	0895
SHARP	0888
SONY	0517
YAMAHA	2500, 2501, 2502

RECEIVER (TUNER)

ADC	0558
AIWA	0185, 1116, 1415, 1432, 1668
ALCO	1417
ANAM	1636
APEX DIGITAL	1284
AUDIOLAB	1216
AUDIOTRONIC	1216
AUDIOVOX	1417
BOSE	1256
CAMBRIDGE SOUNDWORKS	1397
CAPETRONIC	0558
CARVER	1116, 1216
CENTREX	1284
DENON	1387
FERGUSON	0558
FINE ARTS	1216
GRUNDIG	1216
HARMAN/KARDON	0137, 1331
INTEGRA	0162, 1325
JBL	0137, 1333
JVC	0101, 0558, 1401, 1522
KLH	1417, 1439
KENWOOD	1054, 1340
MCS	0066
MAGNAVOX	0558, 1116, 1216, 1296, 1316
MARANTZ	0066, 1116, 1216, 1316
MICROMEGA	1216
MUSICMAGIC	1116
MYRYAD	1216
NAD	0347
NORCENT	1416
ONKYO	0162, 0869, 1325
OPTIMUS	0558, 1050
PANASONIC	0066, 1315, 1545, 1790
PHILIPS	1116, 1216, 1293, 1295, 1296, 1310, 1316
PIONEER	0041, 0558, 1050, 1411
POLK AUDIO	1316
PROSCAN	1281
QUASAR	0066
RCA	0558, 1050, 1281, 1417, 1636,
SABA	0558
SANSUI	1116
SCHNEIDER	0558
SONY	0185, 1085, 1185, 1685, 1785
STEREOPHONICS	1050
SUNFIRE	1340
TEAC	1417
TECHNICS	0066, 1335, 1336, 1545
TELEFUNKEN	0558
THOMSON	1281
THORENS	1216
UHER	0558

VENTURER	1417
VICTOR	0101
WARDS	0041, 0185
YAMAHA	0203, 1203, 1358, 2600, 2601

SATELLITE TUNER

@SAT	1327
ABSAT	0150
ALBA	0482
ALPHASTAR	0799
AMSTRAD	0874
ASTON	0169, 1156
ASTRO	0200
ATSAT	1327
AVALON	0423
BLAUPUNKT	0200
BRITISH SKY BROADCASTING	0874, 1202
CANAL DIGITAL	0880
CANAL SATELLITE	0880
CANAL+	0880
CHAPARRAL	0243
CITYCOM	1203
CONNEXIONS	0423
CROSSDIGITAL	1136
CYRUS	0227
D-BOX	0750, 1154
DMT	1102
DNT	0227, 0423
DAERYUNG	0423
DAEWOO	1323
DIGENIUS	0326
DIRECTV	0274, 0419, 0593, 0666, 0751, 0776, 0846, 1103, 1136, 1169, 1776, 1883
DISH NETWORK SYSTEM	0802, 1032
DISHPRO	0802, 1032
DISTRATEL	0111
DREAM MULTIMEDIA	1264
ECHOSTAR	0194, 0423, 0637, 0802, 0880, 0898, 1032, 1113
ENGEL	1044
EXPRESSVU	0802
FTE	0890
FINLUX	0482
FRACARRO	0898
FUBA	0423
GE	0593
GOI	0802
GALAXIS	0890, 1138
GENERAL INSTRUMENT	0896
GOLD BOX	0880
GRUNDIG	0200, 0874
HTS	0802
HIRSCHMANN	0200, 0423
HITACHI	0482, 0846
HUGHES NETWORK SYSTEM	0776, 1169, 1776
HUMAX	0890, 1203
INVIDEO	0898
JVC	0802
KATHREIN	0150, 0200, 0227, 0276, 0685, 1248
KREISELMEYER	0200
LABGEAR	1323
LOGIX	1044
LORENZEN	0326
MAGNAVOX	0749, 0751

MANHATTAN	0482, 1044, 1110
MARANTZ	0227
MEDIASAT	0880
MEMOREX	0751
METRONIC	0111
MITSUBISHI	0776
MOTOROLA	0896
MYRYAD	0227
NEXT LEVEL	0896
NOKIA	0482, 0750, 0778, 1154, 1250, 1750
OCTALTV	1032
ORBITECH	1127
PACE	0482, 0874, 1202, 1350
PANASONIC	0274, 0728, 0874, 1347
PANDA	0482
PAYSAT	0751
PHILIPS	0160, 0227, 0482, 0749, 0751, 0776, 0880, 1103, 1169, 1776
PIONEER	0880
PROMAX	0482
PROSCAN	0419, 0593
RCA	0170, 0419, 0593, 0882
RFT	0227
RADIOSHACK	0896
RADIOLA	0227
RADIX	0423
SKY	0874, 0883, 1202
SM ELECTRONIC	1227
SABRE	0482
SAGEM	0847, 1141, 1280
SAMSUNG	1044, 1136, 1303, 1319
SAT CONTROL	1327
SATSTATION	1110
SCHWAIGER	1138
SEEMANN	0423
SIEMENS	0200
SONY	0666, 0874, 1666
STAR CHOICE	0896
STRONG	1327
TPS	0847, 1280
TANTEC	0482
TECHNISAT	1126, 1127
TELESTAR	1127
THOMSON	0482, 0880, 1073, 1318
TOPFIELD	1233
TOSHIBA	0776, 0817, 1776
ULTIMATETV	0419, 0666
UNIDEN	0749, 0751
UNIVERSUM	0200
VENTANA	0227
WISI	0200, 0423, 0482
XSAT	0150
ZEHNDER	1102
ZENITH	0883, 1883

TAPE DECK

AIWA	0056
CARVER	0056
GRUNDIG	0056
HARMAN/KARDON	0056
MAGNAVOX	0056
MARANTZ	0056
MYRYAD	0056
OPTIMUS	0054

PHILIPS	0056
PIONEER	0054
POLK AUDIO	0056
RCA	0054
REVOX	0056
SANSUI	0056
SONY	0270
THORENS	0056
WARDS	0054
YAMAHA	2700,2701

TV

AGB	0543
AOC	0036, 0057, 0087, 0119, 0120, 0135, 0205, 0207, 0478
ASA	0131
AWA	0036
ACURA	0036
ADDISON	0119, 0135, 0680
ADMIRAL	0120, 0190, 0490
ADVENT	0788
AIKO	0119
AKAI	0036, 0057, 0235, 0388, 0543, 0729, 0839
AKURA	0291
ALBA	0036, 0064, 0398, 0695
AMERICA ACTION	0207
AMPRO	0778
AMSTRAD	0036, 0064, 0198, 0398, 0439, 0460, 0543
ANAM	0036, 0207, 0277
ANAM NATIONAL	0277, 0677
ANITECH	0036
APEX DIGITAL	0775, 0792, 0794
AUDIOSONIC	0064, 0136
BANG & OLUFSEN	0592
BASIC	0036
BAUR	0064, 0388, 0539
BAYSONIC	0207
BEAUMARK	0205
BEKO	0397, 0513, 0741, 0742
BELL & HOWELL	0181
BEON	0064
BLAUPUNKT	0222
BLUE SKY	0695, 1064
BONDSTEC	0274
BRADFORD	0207
BRANDT	0136, 0362
BROKSONIC	0263, 0490
BUSH	0036, 0064, 0398, 0401, 0695, 1064
CCE	0064
CGE	0274
CTC	0274
CXC	0207
CANDLE	0057
CARNIVALE	0057
CARVER	0081, 0197
CASCADE	0036
CATHAY	0064
CELEBRITY	0027
CELERA	0792
CENTURION	0064
CHANGHONG	0792
CHING TAI	0036, 0119
CHUN YUN	0027, 0036, 0119, 0207
CHUNG HSIN	0080, 0135, 0207

CIMLINE	0036	GOLDSTAR	0057, 0064, 0136,	M ELECTRONIC	0036, 0064,	PENNEY	0057, 0074, 0078,
CINERAL	0119, 0478		0181, 0205, 0404		0131, 0132, 0136,		0087, 0183, 0205,
CITIZEN	0057, 0087, 0119	GOODMANS	0064, 0398, 0401,		0190, 0314, 0373,		1374
CLARION	0207		0661		0401, 0507	PERDIO	0347
CLARIVOX	0064	GOREMJE	0397	MGA	0057, 0177, 0205	PHILCO	0057, 0064, 0081,
CLATRONIC	0274, 0397	GRADIENTE	0080, 0197	MTC	0057, 0087, 0539		0172, 0205, 0207,
CONDOR	0347, 0397	GRAETZ	0190, 0388	MAGNADYNE	0274, 0543		0274, 0490, 1688
CONRAC	0835	GRANADA	0064, 0235, 0366,	MAGNAFON	0543	PHILIPS	0027, 0057, 0064,
CONTEC	0036, 0207		0543	MAGNAVOX	0057, 0081, 1281,		0078, 0081, 0119,
CRAIG	0207	GRANDIN	0637		1481		0135, 0205, 0401,
CROSLEY	0081	GRUNDIG	0064, 0222, 0514,	MANESTH	0291, 0347		0583, 0717, 1481
CROWN	0036, 0064, 0207,		0583, 0614	MARANTZ	0057, 0064, 0081,	PHONOLA	0064
	0397, 0445	GRUNPY	0207		0583	PILOT	0057
CURTIS MATHES	0057, 0074,	HCM	0036, 0439	MARK	0064	PIONEER	0136, 0190, 0193,
	0081, 0087, 0120,	HALLMARK	0205	MATSUI	0036, 0064, 0235,		0314, 0706, 0787,
	0172, 0181, 0193,	HANKOOK	0057, 0205, 0207		0398, 0514, 0543		0893
	0478, 0729, 1174,	HANSEATIC	0064, 0347, 0388,	MATSUSHITA	0277, 0677	PORTLAND	0119
	1374		0455, 0583	MEDIATOR	0064	PRANDONI-PRINCE	
DAEWOO	0036, 0057, 0064,	HANTAREX	0543	MEDION	0695, 0835, 1064		0543
	0119, 0135, 0181,	HARMAN/KARDON	0081	MEGATRON	0172, 0205	PRIMA	0788
	0197, 0205, 0207,	HARVARD	0207	MEMOREX	0036, 0177, 0181,	PRISM	0078
	0401, 0478, 0650,	HAVERMY	0120		0205, 0277, 0490,	PROFEX	0036, 0388
	0661, 1688	HELLO KITTY	0478		1064	PROSCAN	0074
DANSAI	0064	HINARI	0036, 0064	METZ	0474	PROTECH	0036, 0064, 0274,
DAYTON	0036	HISAWA	0482	MICROMAXX	0835		0291, 0445, 0695
DE GRAAF	0235, 0575	HITACHI	0036, 0057, 0119,	MICROSTAR	0835	PROTON	0036, 0057, 0205
DECCA	0064, 0543		0132, 0136, 0172,	MIDLAND	0044, 0074, 0078	PULSAR	0044
DENON	0172		0190, 0205, 0252,	MINERVA	0514	QUASAR	0078, 0277, 0677
DIGATRON	0064		0383, 0508, 0575,	MINOKA	0439	QUELLE	0064, 0131, 0388,
DIXI	0036, 0064		0605, 1172, 1283	MITSUBISHI	0057, 0120, 0135,		0539
DUMONT	0044	HUA TUN	0036		0177, 0181, 0205,	R-LINE	0064
DWIN	0747, 0801	HUANYU	0401		0207, 0263, 0277,	RCA	0027, 0057, 0074,
ECE	0064	HYPSON	0064, 0291		0539, 0863, 1277		0117, 0119, 0205,
ELBE	0286	ICE	0291, 0398	MIVAR	0318, 0319, 0543,		0706, 1074, 1174,
ELECTROBAND	0027	ITS	0398		0636		1274, 1374, 1474,
ELIN	0064, 0575	ITT	0190, 0388, 0575	MOTOROLA	0120		1481, 1574
ELITE	0347	IMPERIAL	0274, 0397, 0445	MOTITECH	0036, 0207	RFT	0455
ELTA	0036	INDIANA	0064	MYRYAD	0583	RADIOSHACK	0057, 0074,
EMERSON	0181, 0205, 0207,	INFINITY	0081	NAD	0183, 0205, 0388,		0181, 0205, 0207
	0263, 0388, 0490,	INGELEN	0190		0893	RADIOLA	0064
	0650	INNO HIT	0543	NEC	0036, 0057, 0078,	RADIOMARELLI	0543
ENVISION	0057, 0840	INNOVA	0064		0181, 0183, 0197,	REALISTIC	0057, 0181, 0205,
EPSON	0860	INTEQ	0044		0205, 0482, 0524,		0207
ERRES	0064	INTERFUNK	0064, 0190, 0274,		1731	REDIFFUSION	0388
ETHER	0036, 0057		0388, 0539	NEI	0064	REOC	0741
ETRON	0036	INTERVISION	0064, 0291,	NTC	0119	REVOX	0064
EUROPHON	0543		0404	NECKERMANN	0064, 0583	REX	0190, 0286, 0291
FERGUSON	0064, 0100, 0136,	JBL	0081	NETSAT	0064	ROADSTAR	0036, 0291, 0445
	0265, 0314, 0362,	JCB	0027	NEWAVE	0036, 0119, 0120,	RUNCO	0044, 0057, 0524,
	0587	JVC	0080, 0398, 0490,		0205		0630
FIDELITY	0388		0680, 0710	NIKKAI	0064, 0291	SBR	0064
FINLANDIA	0235, 0373	JEAN	0036, 0078, 0119,	NIKKO	0057, 0119, 0205	SEG	0291, 0695
FINLUX	0064, 0131, 0132,		0183, 0263	NOKIA	0388, 0500, 0507,	SEI	0543
	0373, 0543	JENSEN	0788		0575, 0658	SKY	0064
FIRSTAR	0036, 0263	KEC	0207	NORCENT	0775, 0851	SSS	0207
FIRSTLINE	0036, 0274, 0695	KTV	0057, 0207	NORDMENDE	0136, 0314,	SABA	0136, 0190, 0314,
FISHER	0131, 0181, 0235,	KAISUI	0036		0587		0362
	0397	KAPSCH	0190	OCEANIC	0190, 0388	SACCS	0265
FLINT	0482	KARCHER	0637	ONWA	0207, 0460	SAGEM	0637
FORMENTI	0064, 0347	KATHREIN	0583	OPTIMUS	0181, 0193, 0277,	SAISHO	0036, 0291, 0543
FORTRESS	0120	KENDO	0064		0677	SALORA	0190, 0380, 0388,
FRONTECH	0190, 0274, 0291	KENWOOD	0057	OPTONICA	0120		0575
FUJITSU	0710, 0836	KNEISSEL	0286, 0462	ORION	0064, 0263, 0347,	SAMBERS	0543
FUNAI	0207, 0198, 0291	KOLIN	0080, 0135, 0207		0490, 0543	SAMPO	0036, 0057, 0119,
FUTURETECH	0207	KORPEL	0064	OSAKI	0291, 0439		0120, 0181, 0198,
GE	0057, 0074, 0078,	KOYODA	0036	OTTO VERSAND	0064, 0347,		0205, 0677, 1782
	0119, 0205, 0207,	L&S ELECTRONIC	0835		0539, 0583	SAMSUNG	0036, 0057, 0064,
	0478, 0587, 1174,	LG	0057, 0064, 0087,	PALLADIUM	0397, 0445		0087, 0117, 0119,
	1374, 1481		0135, 0205, 0741	PANAMA	0291		0181, 0205, 0291,
GEC	0064, 0543	LXI	0074, 0081, 0181,	PANASONIC	0064, 0078, 0081,		0397, 0583, 0614,
GATEWAY	1782, 1783		0183, 0205		0190, 0277, 0677,		0645, 0729, 0793,
GELOSO	0036	LEYCO	0064, 0291		1437		0839, 0841
GENEXXA	0190	LIESENK & TTER	0064	PATHE CINEMA	0265, 0347	SANSEI	0478
GIBRALTER	0044, 0057	LOEWE	0539	PAUSA	0036	SANSUI	0490
		LUXOR	0383, 0388				

SANYO	0131, 0181, 0207, 0235, 0366, 0826	THORN	0064, 0131, 0388, 0539	CIMLINE	0099	JVC	0068, 0072, 0094
SCHAUB LORENZ	0388	TOSHIBA	0087, 0181, 0183, 0535, 0645, 0677, 0859, 1283, 1383, 1683, 1731	CINERAL	0305	JENSEN	0068
SCHNEIDER	0064, 0274, 0398, 0695	TRIUMPH	0543	CITIZEN	0064, 0305, 1305	KEC	0064, 0305
SCOTCH	0205	TUNTEX	0036, 0057, 0119	COLT	0099	KLH	0099
SCOTT	0205, 0207, 0263	UHER	0347	COMBITECH	0379	KAISUI	0099
SEARS	0074, 0081, 0181, 0183, 0198, 0205	UNIVERSUM	0064, 0131, 0132, 0291, 0373, 0397, 0519	CRAIG	0064, 0074, 0099, 0267	KENWOOD	0068, 0094
SELECO	0190, 0286	VECTOR RESEARCH	0057	CROWN	0099, 0305	KODAK	0062, 0064
SEMIVOX	0207	VESTEL	0064	CURTIS MATHES	0062, 0068, 0087, 1062	KOLIN	0068, 0070
SEMP	0183	VICTOR	0080, 0277, 0677, 0680	CYBERNEX	0267	KORPEL	0099
SHARP	0057, 0120, 0677	VIDEOSAT	0274	CYRUS	0108	LG	0064, 0069, 0072, 0507
SHEN YING	0036, 0119	VIDIKRON	0081	DAEWOO	0072, 0131, 0305, 0669, 1305	LXI	0064
SHENG CHIA	0036, 0120, 0263	VIDTECH	0205	DANSAI	0099	LENCO	0305
SIAREM	0543	VIEWSONIC	1782	DE GRAAF	0069	LEYCO	0099
SIEMENS	0064, 0222	VISION	0347	DECCA	0027, 0108	LLOYD'S	0027
SINUDYNE	0543	VOXSON	0190	DENON	0069	LOEWE	0064, 0108, 1589
SKANTIC	0383	WALTHAM	0383	DUAL	0068	LOGIK	0099, 0267
SKYGIANT	0207	WARDS	0057, 0081, 0205, 0893	DUMONT	0027, 0108, 0131	LUXOR	0070, 0075, 0131
SKYWORTH	0064	WATSON	0064, 0347	DYNATECH	0027	M ELECTRONIC	0027
SOLAVOX	0190	WAYCON	0183	ESC	0267, 0305	MEI	0062
SONITRON	0235	WHITE WESTINGHOUSE	0064, 0347, 0490, 0650	ELCATECH	0099	MGA	0070, 0267
SONOKO	0036, 0064	YAMAHA	0057, 0796, 0860, 2900, 2901, 2902	ELECTROHOME	0064	MGN TECHNOLOGY	0267
SONOLOR	0190, 0235	YAPSHE	0277	ELECTROPHONIC	0064	MTC	0027, 0267
SONTEC	0064	YOKO	0064, 0291	EMEREX	0059	MAGNASONIC	1305
SONY	0027, 0677, 0861, 1127, 1532, 1678	ZENITH	0044, 0119, 0205, 0490	EMERSON	0027, 0062, 0064, 0070, 0072, 0211, 0267, 0305, 1305, 1506	MAGNAVOX	0027, 0062, 0066, 0108, 1808
SOUNDESIGN	0205, 0207			FERGUSON	0068, 0347	MAGNIN	0267
SOUNDWAVE	0064, 0445			FIDELITY	0027	MANESTH	0072, 0099
SOWA	0078, 0087, 0119, 0183, 0205			FINLANDIA	0108, 0131	MARANTZ	0062, 0108
SQUAREVIEW	0198			FINLUX	0027, 0069, 0108, 0131	MARTA	0064
STANDARD	0036			FIRSTLINE	0064, 0070, 0072, 0099	MATSUI	0375, 0379
STARLITE	0207			FISHER	0074, 0131	MATSUSHITA	0062
STERN	0190, 0286			FUJI	0060, 0062	MEDION	0375
SUPREME	0027			FUJITSU	0027, 0072	MEMOREX	0027, 0062, 0064, 0066, 0074, 0075, 0131, 0267, 0334, 0375, 1264
SYLVANIA	0057, 0081, 0198			FUNAI	0027	MEMPHIS	0099
SYMPHONIC	0198, 0207			GE	0062, 0087, 0267, 0834, 1062, 1087	METZ	0064, 0374, 1589
SYNCO	0027, 0087, 0119, 0120, 0205, 0478			GEC	0108	MINOLTA	0069
SYSLINE	0064			GARRARD	0027	MITSUBISHI	0068, 0070, 0094, 0108, 0834
T + A	0474			GENERAL	0072	MOTOROLA	0062, 0075
TCM	0835			GO VIDEO	0459	MULTITECH	0027, 0099
TMK	0205			GOLDHAND	0099	MURPHY	0027
TNCI	0044			GOLDSTAR	0064, 0252, 0507, 1264	MYRYAD	0108
TVS	0490			GOODMANS	0027, 0064, 0099, 0305	NAD	0131
TACICO	0036, 0119, 0205			GRADIENTE	0027	NEC	0062, 0064, 0068, 0075, 0094, 0131
TAI YI	0036			GRAEZE	0068, 0131, 0267	NATIONAL	0253
TANDY	0120, 0190			GRANADA	0108, 0131	NECKERMANN	0108
TASHIKO	0119, 0677			GRANDIN	0027, 0064, 0099	NESCO	0099
TATUNG	0036, 0064, 0078, 0081, 0087, 0181, 0183, 0543			GRUNDIG	0099, 0108, 0253, 0374	NEWAVE	0064
TEAC	0036, 0064, 0291, 0439, 0445, 0482, 0695, 1064			HCM	0099	NIKKO	0064
TEC	0274			HI-Q	0074	NOBLEX	0267
TECHNEMA	0347			HANSEATIC	0064	NOKIA	0068, 0131, 0267
TECHNICS	0078, 0277, 0677			HARLEY DAVIDSON	0027	NORDMENDE	0068, 0347
TECHWOOD	0078			HARMAN/KARDON	0108	OCEANIC	0027, 0068
TECO	0036, 0078, 0119, 0120, 0205, 0291, 0680			HARWOOD	0099	OKANO	0342, 0375
TEKNIKA	0081, 0087, 0119, 0177, 0207			HINARI	0099, 0267, 0379	OLYMPUS	0062, 0253
TELEFUNKEN	0136, 0289, 0362, 0652, 0729			HITACHI	0027, 0064, 0068, 0069, 0267	OPTIMUS	0064, 0075, 0131, 0459
TELEMEISTER	0347			HUGHES NETWORK SYSTEMS	0069	ORION	0211, 0375, 0379, 1506
TELETECH	0036			HYPSON	0099	OSAKI	0027, 0064, 0099
TENSAI	0347			ITT	0068, 0131, 0267	OTTO VERSAND	0108
TERA	0057			ITV	0064, 0305	PALLADIUM	0064, 0068, 0099
THOMSON	0136, 0314, 0587, 0652, 1474			IMPERIAL	0027	PANASONIC	0062, 0252, 0253, 0643, 1062, 1589
				INTERFUNK	0108	PATHE MARCONI	0068
						PENNEY	0062, 0064, 0069, 0267, 1062, 1264
						PENTAX	0069
						PERDIO	0027

VCR

ASA	0064, 0108
ADMIRAL	0075
ADVENTURA	0027
AIKO	0305
AIWA	0027, 0064, 0334, 0375, 0379
AKAI	0068, 0342
AKIBA	0099
ALBA	0099, 0305, 0342, 0379
AMERICA ACTION	0305
AMERICAN HIGH	0062
AMSTRAD	0027
ANAM	0064, 0253, 0267, 0305, 0507
ANAM NATIONAL	0253, 1589
ANITECH	0099
ASHA	0267
ASUKA	0064
AUDIOVOX	0064, 0305
BAIRD	0027, 0068, 0131
BASIC LINE	0099, 0305
BEAUMARK	0267
BELL & HOWELL	0131
BLAUPUNKT	0253
BRANDT	0347
BRANDT ELECTRONIC	0068
BROKSONIC	0211, 0375, 1506
BUSH	0099, 0305, 0379
CCE	0099, 0305
CGE	0027
CALIX	0064
CANON	0062
CARVER	0108

PHILCO	0062	SONY	0027, 0059, 0060,
PHILIPS	0062, 0108, 0645,		0062, 0663, 1259
	1108, 1208	SUNKAI	0375
PHONOLA	0108	SUNSTAR	0027
PILOT	0064	SUNTRONIC	0027
PIONEER	0069, 0094, 0108	SYLVANIA	0027, 0062, 0108,
POLK AUDIO	0108		0070, 1808
PROFITRONIC	0267	SYMPHONIC	0027
PROLINE	0027	TMK	0267
PROSCAN	0087, 1087	TANDY	0027, 0131
PROTEC	0099	TASHIKO	0027, 0064
PULSAR	0066	TATUNG	0027, 0068, 0072,
PYE	0108		0094, 0108
QUASAR	0062, 1062	TEAC	0027, 0068, 0305,
QUELLE	0108		0334, 0669
RCA	0062, 0069, 0087,	TECHNICS	0062, 0253
	0267, 0834, 1062,	TECO	0062, 0064, 0068,
	1087		0075
RADIOSHACK	0027	TEKNIKA	0027, 0062, 0064
RADIOLA	0108	TELEAVIA	0068
RADIX	0064	TELEFUNKEN	0068, 0347
RANDEX	0064	TENOSAL	0099
REALISTIC	0027, 0062, 0064,	TENSAI	0027
	0074, 0075, 0131	THOMAS	0027
REOC	0375	THOMSON	0068, 0087, 0094,
REPLAYTV	0641, 0643		0347
REX	0068	THORN	0068, 0131
ROADSTAR	0064, 0099, 0267,	TIVO	0645, 0663
	0305	TOSHIBA	0068, 0070, 0072,
RUNCO	0066		0094, 0108, 0872
SBR	0108	TOTEVISION	0064, 0267
SEG	0267	UHER	0267
SEI	0108	UNITECH	0267
STS	0069	UNIVERSUM	0027, 0064, 0108,
SABA	0068, 0347		0267
SALORA	0070	VECTOR	0072
SAMPO	0064, 0075	VICTOR	0068, 0094
SAMSUNG	0072, 0267, 0459	VIDEO CONCEPTS	0072
SANKY	0066, 0075	VIDEOMAGIC	0064
SANSUI	0027, 0068, 0094,	VIDEOSONIC	0267
	1506	VILLAIN	0027
SANYO	0074, 0131, 0267	WARDS	0027, 0062, 0069,
SAVILLE	0379		0074, 0075, 0087,
SCHAUB LORENZ	0027, 0068,		0099, 0108, 0267
	0131	WHITE WESTINGHOUSE	0099
SCHNEIDER	0027, 0099, 0108		
SCOTT	0070, 0072, 0211	XR-1000	0027, 0062, 0099
SEARS	0027, 0062, 0064,	YAMAHA	0068
	0069, 0074, 0131,	YAMISHI	0099
	1264	YOKAN	0099
SELECO	0068	YOKO	0267
SEMP	0072	ZENITH	0027, 0060, 0066,
SHARP	0075, 0834		1506
SHINTOM	0099, 0131		
SIEMENS	0064, 0108, 0131		
SILVA	0064		
SINGER	0072, 0099		
SINUDYNE	0108		
SONIC BLUE	0641, 0643		
SONTEC	0064		



© 2005 YAMAHA CORPORATION All rights reserved.

YAMAHA ELECTRONICS CORPORATION, USA 6660 ORANGETHORPE AVE., BUENA PARK, CALIF. 90620, U.S.A.
 YAMAHA CANADA MUSIC LTD. 135 MILNER AVE., SCARBOROUGH, ONTARIO M1S 3R1, CANADA
 YAMAHA ELECTRONIK EUROPA G.m.b.H. SIEMENSSTR. 22-34, 25462 RELINGEN BEI HAMBURG, GERMANY
 YAMAHA ELECTRONIQUE FRANCE S.A. RUE AMBROISE CROIZAT BP70 CROISSY-BEAUBOURG 77312 MARNE-LA-VALLEE CEDEX02, FRANCE
 YAMAHA ELECTRONICS (UK) LTD. YAMAHA HOUSE, 200 RICKMANSWORTH ROAD WATFORD, HERTS WD18 7GQ, ENGLAND
 YAMAHA SCANDINAVIA A.B. J A WETTERGRENS GATA 1, BOX 30053, 400 43 VÄSTRA FRÖLUNDA, SWEDEN
 YAMAHA MUSIC AUSTRALIA PTY, LTD. 17-33 MARKET ST., SOUTH MELBOURNE, 3205 VIC., AUSTRALIA

YAMAHA CORPORATION

Printed in Malaysia © WE64820

Free Manuals Download Website

<http://myh66.com>

<http://usermanuals.us>

<http://www.somanuals.com>

<http://www.4manuals.cc>

<http://www.manual-lib.com>

<http://www.404manual.com>

<http://www.luxmanual.com>

<http://aubethermostatmanual.com>

Golf course search by state

<http://golfingnear.com>

Email search by domain

<http://emailbydomain.com>

Auto manuals search

<http://auto.somanuals.com>

TV manuals search

<http://tv.somanuals.com>