

# disklavier

---

■ ■ ■ ■ T V ■ ■ ■ ■

powered by *RemoteLive™*

## User's Guide

This service is available for U.S. customers only.

# Table of Contents

<b>Introduction</b> .....	4
<b>Names of Parts and Their Functions</b> .....	4
Control Unit (Front) .....	4
Control Unit (Rear).....	5
Remote Control .....	6
<b>Connection Diagram (Basic)</b> .....	8
<b>Connecting the Disklavier to the Internet</b> .....	8
Preparation.....	8
Connecting the Control Unit to the Internet .....	8
Notes on Network Security .....	9
<b>Watching on Your Computer</b> .....	10
<b>Watching on Your TV</b> .....	11
<b>Preparation</b> .....	12
<b>Turning on Your Disklavier</b> .....	12
<b>Registration</b> .....	13
<b>Updating Your Disklavier</b> .....	14
<b>Logging into Your Account</b> .....	17
Entering Characters.....	19
<b>Activating DisklavierTV</b> .....	20
<b>Receiving Test</b> .....	20
<b>Viewing Live Broadcast or On-demand Content</b> .....	22
<b>Adjustments</b> .....	24
<b>Adjusting the Main Volume</b> .....	24
<b>Adjusting the Audio Volume Balance</b> .....	25

<b>Connection Diagram (Advanced)</b> .....	26
<b>Watching on Your Computer with External Speakers</b> .....	26
<b>Watching on Your TV with External Speakers</b> .....	27
<b>Watching Video with High Quality Audio and External Monitor</b> .....	28
<b>Appendix</b> .....	29
<b>Windows 7 and 8 Audio Considerations</b> .....	29
<b>Adjusting the Delay</b> .....	30
<b>Adjusting the Depth of the Sustain Pedal</b> .....	31
<b>Network Diagnostics</b> .....	32
<b>Checking the Broadcast Information and Error History</b> .....	33
<b>Troubleshooting</b> .....	34
Error Messages .....	34

# Introduction

## Names of Parts and Their Functions

### ■ Control Unit (Front)

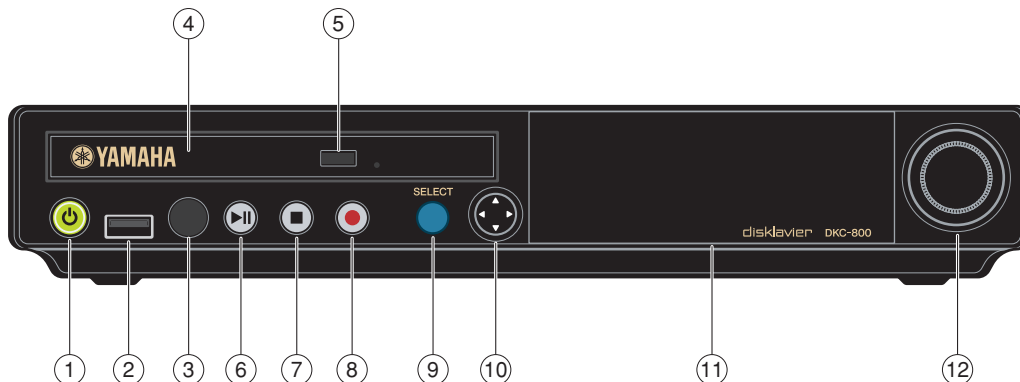

- ① **[ON/OFF] button**   
Turns on or turns off the Disklavier.  
Press once to turn it on, and once again to turn it off.
- ② **USB port**  
Used to connect a USB flash memory, etc.
- ③ **Remote control sensor**  
When using the remote control, point it toward this sensor.
- ④ **CD drive**  
Insert a PianoSoft·PlusAudio or other audio or audio/MIDI CD here.
- ⑤ **CD eject button**  
Used to open the CD drive.
- ⑥ **[PLAY/PAUSE] button**  
Used to start and pause playback.
- ⑦ **[STOP] button**  
Used to stop playback and recording.
- ⑧ **[RECORD] button**  
Used to engage the record standby mode before recording starts.

- ⑨ **[SELECT] button**  
Used to select media.
- ⑩ **Cursor/[ENTER] buttons**  
Cursor: Used to select options and parameters.



Press this button inclining slightly upward/downward/left/right.

[ENTER]: Used to execute the selection.



Press in the very center of this button.

- ⑪ **Display**  
Shows various information.
- ⑫ **Dial**  
Used to adjust the volume, and to set parameter values.

## ■ Control Unit (Rear)

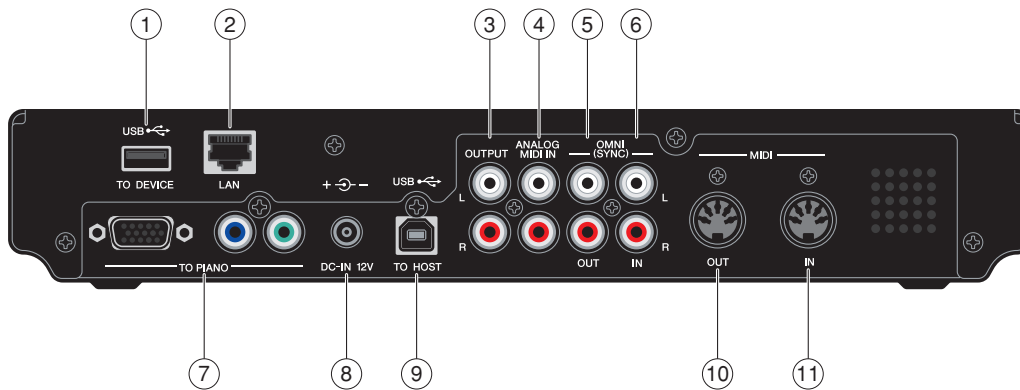

### ① USB TO DEVICE port

Used to connect a USB flash memory, an optional USB floppy disk drive, etc.

### ② LAN port

Used to connect to the Internet.

### ③ OUTPUT jacks

Used to connect speaker cables to monitor speakers\*

### ④ ANALOG MIDI IN jacks

Used to connect audio equipment such as an external CD changer.

### ⑤ OMNI (SYNC) OUT jacks

Used to connect the microphone/line input of a camcorder.

### ⑥ OMNI (SYNC) IN jacks

Used to connect the audio output of a camcorder or computer.

### ⑦ TO PIANO connectors

Used to connect the piano.

### ⑧ DC-IN 12V connector

Used to connect to the power supply unit.

### ⑨ USB TO HOST port

Used to connect the USB cable from a computer.

### ⑩ MIDI OUT terminal

Used to connect external MIDI equipment for outputting MIDI data.

### ⑪ MIDI IN terminal

Used to connect external MIDI equipment for inputting MIDI data.

\* Only for models supplied with monitor speakers.

## ■ Remote Control

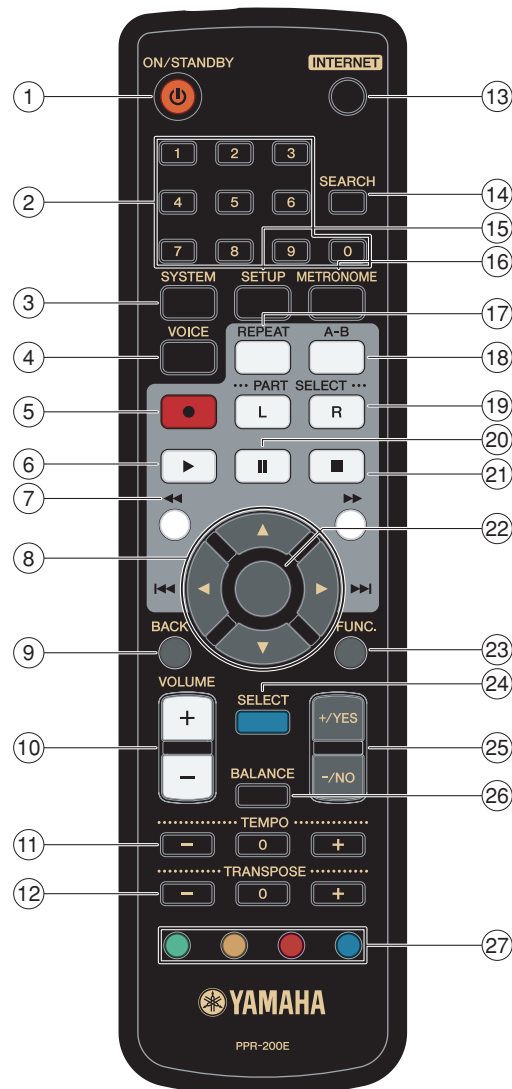

- |  |  |
|--|--|
| <p>① <b>[ON/STANDBY] button</b> </p> <p>Turns on the Disklavier or puts it in standby mode.</p> | <p>⑤ <b>[RECORD] button</b></p> <p>Used to engage the record standby mode before recording starts.</p>   |
| <p>② <b>Number keypad</b></p> <p>Used for direct album/song selection and to enter a start time for song playback.</p>   | <p>⑥ <b>[PLAY] button</b></p> <p>Used to start playback.</p>   |
| <p>③ <b>[SYSTEM] button</b></p> <p>Used to access the system menu.</p>   | <p>⑦ <b>[REVERSE]/[FORWARD] buttons</b></p> <p>In the play mode: used to fast preview and review.</p> <p>In the pause mode: used to fast forward and rewind.</p> |
| <p>④ <b>[VOICE] button</b></p> <p>Used to access the voice function.</p>   |  |

- ⑧ **Cursor buttons**  
Used to select options and parameters.
- ⑨ **[BACK] button**  
Used to cancel the selection, and return to the previous screen.
- ⑩ **[VOLUME] buttons**  
Used to adjust the volume.  
[-] lowers the volume, [+] raises the volume.
- ⑪ **[TEMPO] buttons**  
Used to change the playback tempo.  
[-] decreases the tempo, [+] increases the tempo, and [0] resets the tempo to 00.
- ⑫ **[TRANSPOSE] buttons**  
Used to transpose song playback.  
[-] transposes down, [+] transposes up, and [0] resets the transposition value to 00.
- ⑬ **[INTERNET] button**  
Used to access the Internet menu.
- ⑭ **[SEARCH] button**  
Used to access the search function.
- ⑮ **[SETUP] button**  
Used to access the setup menu.
- ⑯ **[METRONOME] button**  
Used to access the metronome function.
- ⑰ **[REPEAT] button**  
Used to select one of the repeat modes: ALL, RPT, RND, or OFF.
- ⑱ **[A-B] button**  
Used to enter A and B points for the A-B repeat mode.
- ⑲ **[PART SELECT] buttons**  
For L/R and ensemble songs, these buttons are used to choose which part will play: left-hand part, right-hand part, or both parts.  
They are also used to select a part for recording.
- ⑳ **[PAUSE] button**  
Used to pause playback.
- ㉑ **[STOP] button**  
Used to stop playback and recording.
- ㉒ **[ENTER] button**  
Used to execute the selection.
- ㉓ **[FUNC.] button**  
Used to access the function menu.
- ㉔ **[SELECT] button**  
Used to select media.
- ㉕ **[+/YES]/[-/NO] buttons**  
Used to select parameters, adjust setting values, and execute or cancel the selected functions.
- ㉖ **[BALANCE] button**  
Used to adjust the TG, audio and voice balance.
- ㉗ **Color buttons**  
Green : Used to execute the shortcut assigned to the number keypad.  
Yellow : Used to switch character types when titling albums and songs.  
Other : For future use.

# Connection Diagram (Basic)

## Connecting the Disklavier to the Internet

You can connect the Disklavier to a full-time online Internet connection (ADSL, optical fiber, cable Internet, etc.) via a router or a modem equipped with a router.

### ■ Preparation

- To use the Internet connection, you will first need to subscribe to an Internet service or provider.
- Use a computer to obtain and configure Internet service. You cannot obtain Internet service or configure router settings on a local area network using the Disklavier itself.
- Use a standard LAN cable to connect the control unit and a router.
- Before connecting the LAN cable, make sure to turn off (or shut down) the Disklavier.

### ■ Connecting the Control Unit to the Internet

#### Connection example 1:

Using a modem with router function

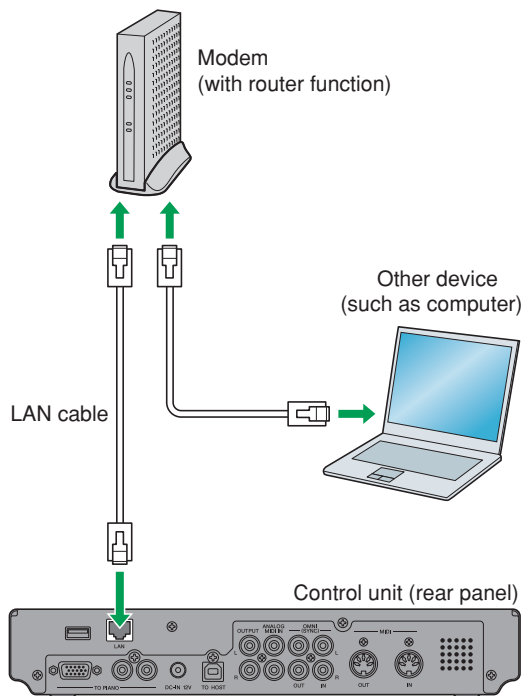

#### Connection example 2:

Using a modem without router function

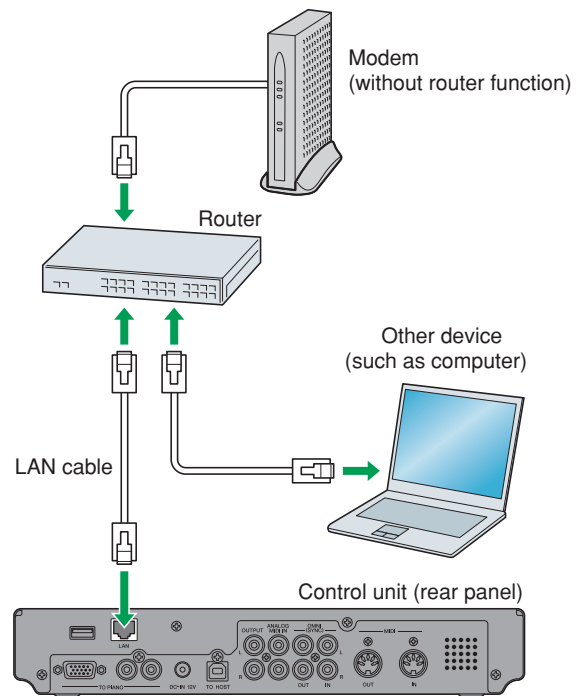

#### Note:

- Depending on the contract with your Internet provider, you may not be able to connect two or more devices (for example, a computer and the Disklavier) to the Internet. Please check your contract or contact your Internet provider for further information.
- Some types of modems (such as ADSL modems or cable modems) have multiple ports for connecting two or more devices (such as computer, musical instrument, etc.). If your modem has only one port, an optional router or hub is required in order to connect several devices simultaneously.



For further information on the Internet connection (only a wired LAN connection is supported), visit the Yamaha Disklavier website:

<http://services.music.yamaha.com/radio/>

### ■ Notes on Network Security

The Disklavier attempts to achieve a balance between security and usability in its network implementation. However, a determined hacker may be able to defeat these security measures and utilize the network of the purchaser in an unauthorized manner. Since each network is different, only the purchaser can determine whether the security measures discussed here will adequately protect their network.

The purchaser acknowledges that connection to the Internet and use of the Disklavier Internet features is done at the risk of the purchaser. In no event shall Yamaha, its subsidiaries or Yamaha's and/or its subsidiaries' directors, officers, or employees be responsible for unauthorized access, loss or alteration of the data of the purchaser or be liable for any damage from intrusions.

## Watching on Your Computer

**Note:** Turn the power off before connecting.

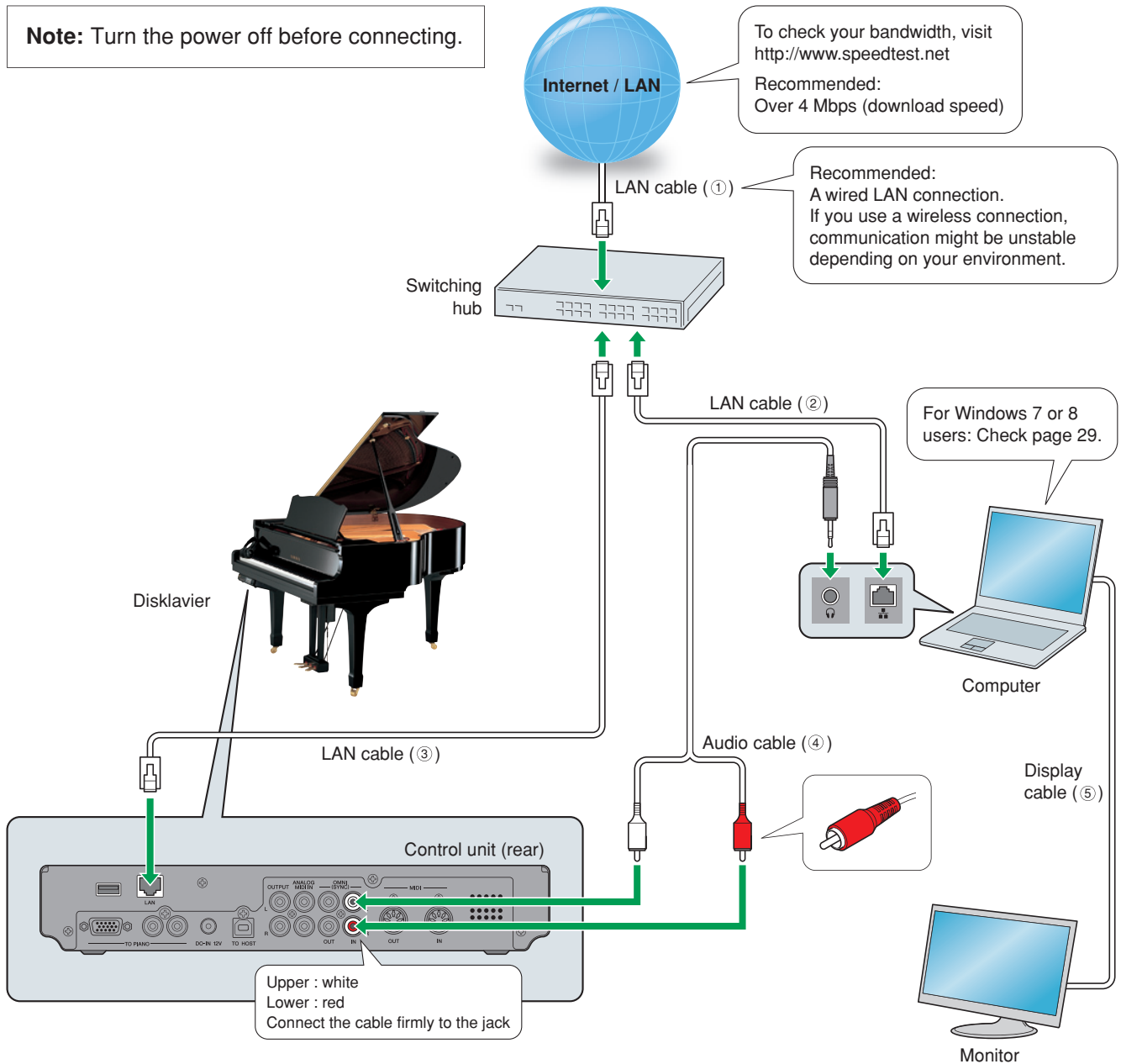

### Requirements (These items are NOT supplied with Disklavier.)

Equipment	
Computer (Windows or Mac)	1
Switching hub *1	1

Cables	From	To	
LAN cable	1	Modem/router	Switching hub ①
LAN cable	1	Switching hub	Computer ②
LAN cable	1	Switching hub	Disklavier ③
Audio cable (stereo mini pin - 2 RCA males) *2	1	Computer	Disklavier (OMNI IN) ④
Display cable	1	Computer	Monitor ⑤

\*1 You do not need the switching hub if your router has more than 2 empty LAN ports.

\*2 DO NOT use cables with impedance changers.

## Watching on Your TV

**Note:** Turn the power off before connecting.

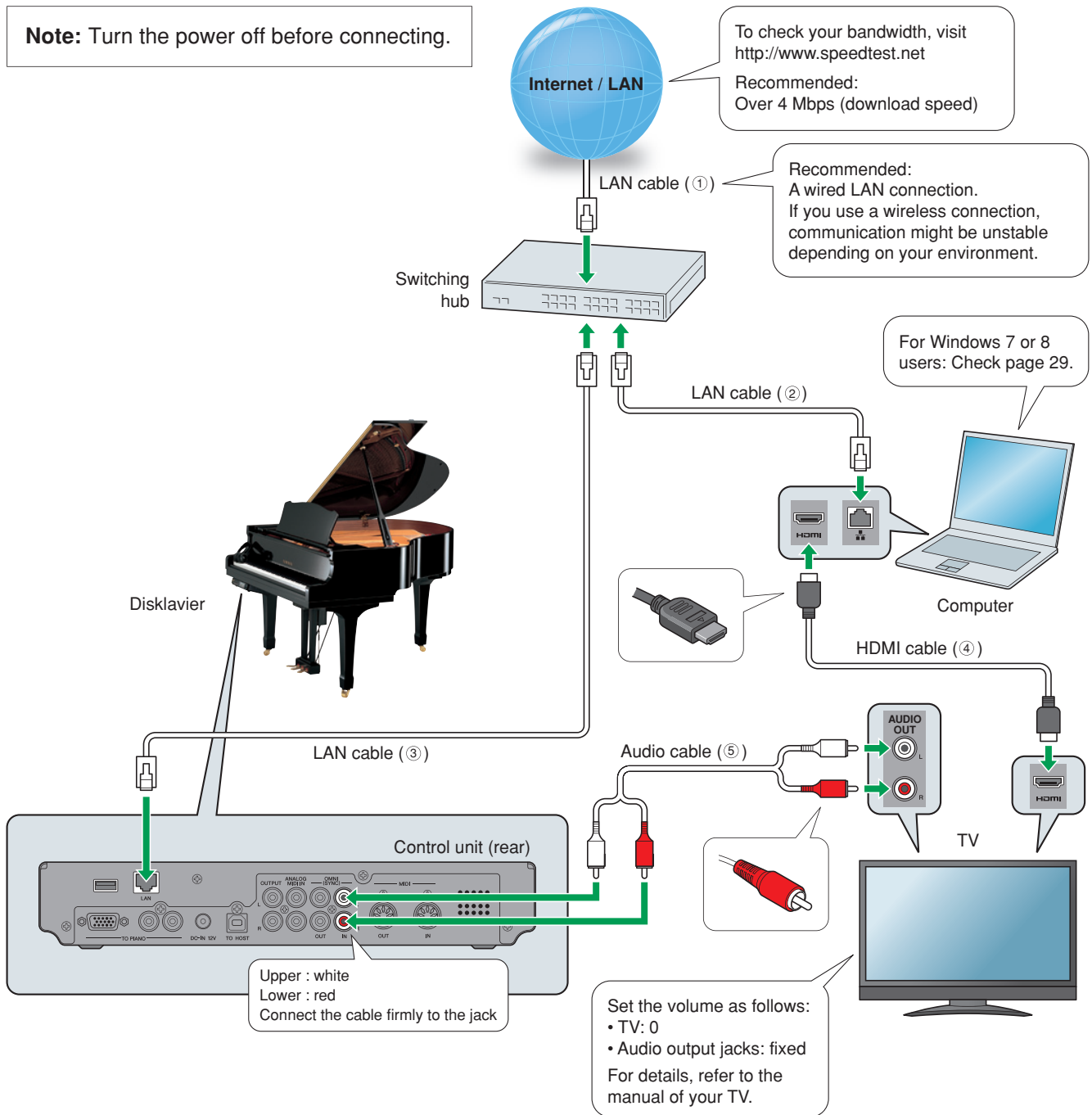

### Requirements (These items are NOT supplied with Disklavier.)

Equipment	
Computer (Windows or Mac)	1
Switching hub *1	1
TV (with HDMI input and audio output)	1

Cables	From	To
LAN cable	1 Modem/router	Switching hub ①
	1 Switching hub	Computer ②
	1 Switching hub	Disklavier ③
HDMI cable	1 Computer	TV ④
Audio cable (2 RCA males - 2 RCA males) *2	1 TV	Disklavier (OMNI IN) ⑤

\*1 You do not need the switching hub if your router has more than 2 empty LAN ports.

\*2 Cable required depends on your TV.

# Preparation

## Turning on Your Disklavier

- 1 Connect the AC power cable to the AC wall outlet.

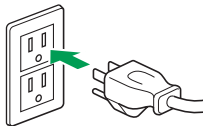

- 2 Press [ON/OFF] on the control unit.



The following message appears on the display, and [ON/OFF] on the control unit lights green.



(The illustration shows an example of Disklavier E3.)

After several seconds, the loading screen will appear, and last played song will be loaded.



Your Disklavier is now ready for use.

## Registration

---

To use the DisklavierTV service, initial registration is required using an Internet-connected computer.

**Note:** If you are already subscribed to the DisklavierRadio service, the following procedure is unnecessary.

- 1** Go to [Yamahamusicsoft.com/dtv](http://Yamahamusicsoft.com/dtv)
- 2** Enter your Disklavier model and select your desired subscription (monthly or annual).
- 3** Click “Subscribe,” then confirm your subscription and your auto-renew preference.
- 4** At checkout, you will be asked to create an account to complete the subscription and registration process.

**Note:** To use the DisklavierTV service, you are required to enter your e-mail address and password with the remote control.

## Updating Your Disklavier

- 1 Confirm that your Disklavier can access the Internet.  
Press [INTERNET] on the remote control.

The Internet menu screen should appear.



If this screen appears, your Internet connection is OK.

**Note:** If you have not connected your Disklavier to the Internet, see “Connecting the Disklavier to the Internet” on page 8 and connect it properly to the Internet.

- 2 Select “Update” with the cursor buttons ([◀] [▶] [▲] [▼]), then press [ENTER].



If there is any update program available, the update screen appears.



Go to step 3.

If you have the latest version of firmware, the following screen will appear.



Scroll down through the screens and select “Close” using the cursor button ([▼]), then press [ENTER].

Skip the following steps and go to “Logging into Your Account” on page 17.

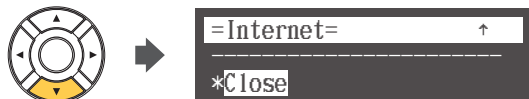

- 3** Scroll down through the screens and select “Firmware U” using the cursor button ([▼]), then press [ENTER].

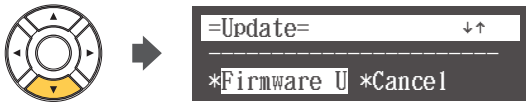

The download process of the update program starts.

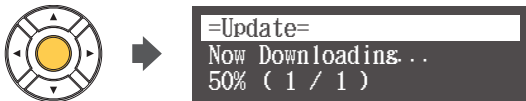

- 4** After the download process is completed, shut down the Disklavier with [ON/OFF] on the control unit.



The update program is now prepared.

- 5** Holding [PLAY/PAUSE] on the control unit, press [ON/OFF].



The current version information of each module appears one after the other.

- 6** Press [ENTER] on the control unit.

The starting screen appears.



(Center of the button)

- 7** Press [ENTER] on the control unit again.

After a while, the update confirmation message of each module appears.

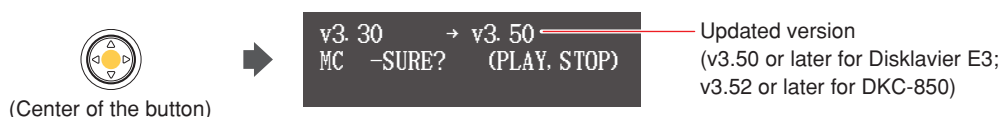

(Center of the button)

## 8 Press [PLAY/PAUSE] to start the update.

**Important:**

- DO NOT turn off this unit during update.
- Be sure to update all the modules.

The update process of the first module takes approximately 3 minutes.



MC v3.30 → v3.50  
DO NOT REMOVE DISK!

When the update of the first module completes, the following confirmation message appears.

### Confirmation message of the second module

v3.30 → v3.50  
CTRL-SURE? (PLAY, STOP)

Updated version  
(v3.50 or later for Disklavier E3;  
v3.52 or later for DKC-850)

Press [PLAY/PAUSE] to start the update of the second module.

The update process of the second module takes approximately 3 minutes.

A total of four modules needs to be updated. Repeat this step to complete the update.

### Confirmation message of the third module

v3.20 → v3.50  
APE -SURE? (PLAY, STOP)

Updated version  
(v3.50 or later for Disklavier E3;  
v3.52 or later for DKC-850)

The update process of the third module takes approximately 2 minutes.

### Confirmation message of the fourth module (Disklavier E3 only)

v2.10 → v3.10  
CSP -SURE? (PLAY, STOP)

Updated version (v3.10 or later)

The update process of the fourth module takes approximately 2 minutes.

The closing screen appears when the update for all modules is completed.

COMPLETE  
Turn OFF, Turn ON again!

## 9 Shut down the Disklavier, then turn it on again.



## Logging into Your Account

**Note:** Once you have logged in, you are kept logged in for 30 days. If you do not access the DisklavierRadio or DisklavierTV services within that period, you need to log in again.

### 1 Press [INTERNET] on the remote control.

The Internet menu screen appears.



### 2 Select "MyAccount" with the cursor buttons ([◀] [▶] [▲] [▼]), then press [ENTER].

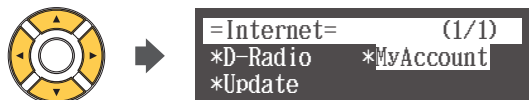

The MyAccount screen appears.



### 3 Press [ENTER].

The warning message appears.



### 4 Scroll down through the screens and select "OK" using the cursor button ([▼]), then press [ENTER].

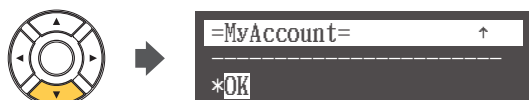

The information entry screen appears.

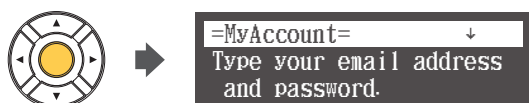

- 5** Select “Email Address” or “Password” with the cursor buttons ([▲] [▼]), and enter your e-mail address and password.



**Note:** See “Entering Characters” on page 19 for information on how to enter characters.

- 6** Select “Submit” with the cursor button ([▼]), then press [ENTER].



If the login is successful, the following screen will appear.



Go to step 7.

If the login fails, the following screen will appear.



Select “Try Again” with the cursor button ([▼]), then press [ENTER].

Go back to step 5 and make sure that you have entered your e-mail address and password correctly.

- 7** Press [ENTER].

The MyAccount screen appears.



- 8** Press [BACK].

If you are successfully logged into your account, “RemoteLive” appears on the Internet menu screen.



You can enjoy the DisklavierTV service using the *RemoteLive* function.

## ■ Entering Characters

### How to Enter Characters with the Remote Control

The following illustration shows how to enter characters with the remote control.

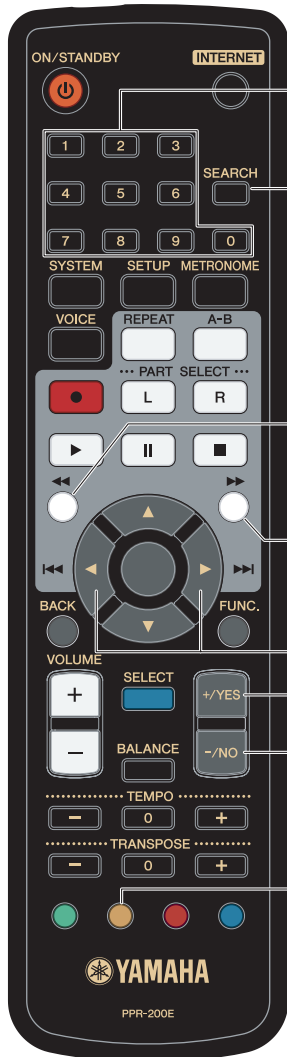

**Number keypad**  
Overwrites with a number.

**[SEARCH] button**  
Overwrites with a dot (.).

**[REVERSE] button**  
Deletes a character. Letters to the right of a deleted character will move one space to the left.

**[FORWARD] button**  
Inserts a space.

**[◀]/[▶] buttons**  
Moves the cursor left and right.

**[+]/[YES]/[-]/[NO] buttons**  
Selects the character. Pressing these keys simultaneously overwrites a space.

**Yellow button**  
Switches the character types.  
The character type cycles as follows each time you press this button:

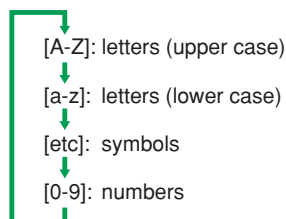

### Available Characters

The following table shows which characters are available.

Character Type	Characters													
Letters (Upper Case) [A-Z]	Space	A	B	C	D	E	F	G	H	I	J	K	L	
	M	N	O	P	Q	R	S	T	U	V	W	X	Y	Z
Letters (Lower Case) [a-z]	Space	a	b	c	d	e	f	g	h	i	j	k	l	
	m	n	o	p	q	r	s	t	u	v	w	x	y	z
Symbols [etc]	Space	!	"	#	\$	%	&	'	(	)	*	+	,	
	-	.	/	:	;	<	=	>	?	_	@			
Numbers [0-9]	Space	0	1	2	3	4	5	6	7	8	9			

# Activating DisklavierTV

## Receiving Test

You can verify that you are properly set up to receive a broadcast by viewing a test video that can be found on the website.

- Caution:**
- While you enjoy live broadcast or on-demand content:
    - DO NOT use other applications except your web browser on your computer.
    - DO NOT visit any other websites (other than the URL provided for the broadcast) on your computer.

- Note:**
- Confirm that the volume on your PC is set to maximum.
  - If you are using a PC with Windows 7 or 8, make sure all sound enhancements are disabled (turned off). See “Appendix” on page 29 for additional detail.

**1** Confirm that all equipment and cables are connected as shown in the “Connection Diagram.”

**2** Confirm that your Disklavier can access the Internet.  
Press [INTERNET] on the remote control.

The Internet menu screen should appear.



If this screen appears, your Internet connection is OK.

You can enjoy the DisklavierTV service using the *RemoteLive* function.

If “RemoteLive” does not appear, see page 17 to log into your account.

**3** Select “RemoteLive” with the cursor buttons ([◀] [▶] [▲] [▼]), then press [ENTER].

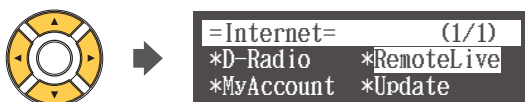

The *RemoteLive* screen appears.

**4** Using the computer, enter the following URL into your browser:

[4wrdr.it/DisklavierTV](http://4wrdr.it/DisklavierTV)

## 5 Go to the “Set Up” page, then start playing back the video on the website.

Your Disklavier starts to receive the data.



=RemoteLive= -- FUNC  
Buffering.

## 6 Confirm that piano playback is synchronized with the video.

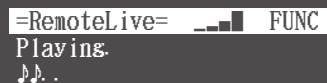

=RemoteLive= --||| FUNC  
Playing.  
♪♪ .

## 7 Confirm that the volume is appropriate.

See page 24 to adjust the volume.

## 8 Stop playing back the video, then press [BACK] on the remote control to return to the Internet menu screen.

BACK  

**Note:** Playback of your piano may continue for a while even after you have stopped playing back the video content. This is not a malfunction.

## Viewing Live Broadcast or On-demand Content

- Caution:**
- While you enjoy live broadcast or on-demand content:
    - DO NOT use other applications except your web browser on your computer.
    - DO NOT visit any other websites (other than the URL provided for the broadcast) on your computer.

- Note:**
- Confirm that the volume on your PC is set to maximum.
  - If you are using a PC with Windows 7 or 8, make sure all sound enhancements are disabled (turned off). See “Appendix” on page 29 for additional detail.

**1** Confirm that all equipment and cables are connected as shown in the “Connection Diagram.”

**2** Confirm that your Disklavier can access the Internet. Press [INTERNET] on the remote control.

The Internet menu screen should appear.



If this screen appears, your Internet connection is OK.

You can enjoy the DisklavierTV service using the *RemoteLive* function.

**3** Select “RemoteLive” with the cursor buttons ([◀] [▶] [▲] [▼]), then press [ENTER].

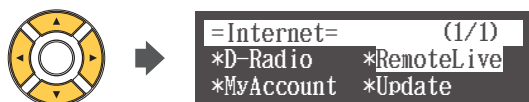

The *RemoteLive* screen appears.

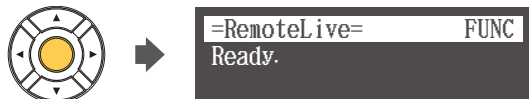

**4** Using the computer, enter the following URL into your browser:

4wrd.it/DisklavierTV

## 5 Start playing back the video on the website.

Your Disklavier starts to receive the data.

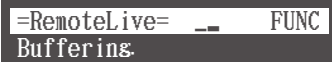

=RemoteLive= -- FUNC  
Buffering.

## 6 Confirm that piano playback is synchronized with the video.

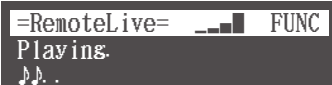

=RemoteLive= --||| FUNC  
Playing.  
♪♪.

## 7 Stop playing back the video, then press [BACK] on the remote control to return to the Internet menu screen.

BACK



**Note:** Playback of your piano may continue for a while even after you have stopped playing back the video content. This is not a malfunction.

# Adjustments

## Adjusting the Main Volume

You can adjust overall volume with the remote control (or the control unit).

### 1 Press [VOLUME +] or [VOLUME -] on the remote control.

The main volume setting screen appears.



### 2 Press [VOLUME +] or [VOLUME -] to adjust the volume.

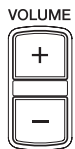

Volume can be adjusted in a range of -10 to 0.

**Note:** You can also use the dial on the control unit to adjust the volume.

The main volume setting screen will disappear after 5 seconds, and the screen returns to the previous one.

If you want to return quickly, press [BACK] on the remote control.





## Adjusting the Audio Volume Balance

You can adjust the volume of the audio in balance with the piano sound.

### 1 Press [BALANCE] on the remote control.

The audio balance setting screen appears.



### 2 Press [+ / YES] and [- / NO] to adjust the volume of the audio.



Audio volume balance can be adjusted in a range of 0 to 127.

**Note:** You can also use the dial on the control unit to adjust the volume.

The audio balance setting screen will disappear after 5 seconds, and the screen returns to the previous one.

If you want to return quickly, press [BACK] on the remote control.



# Connection Diagram (Advanced)

## Watching on Your Computer with External Speakers

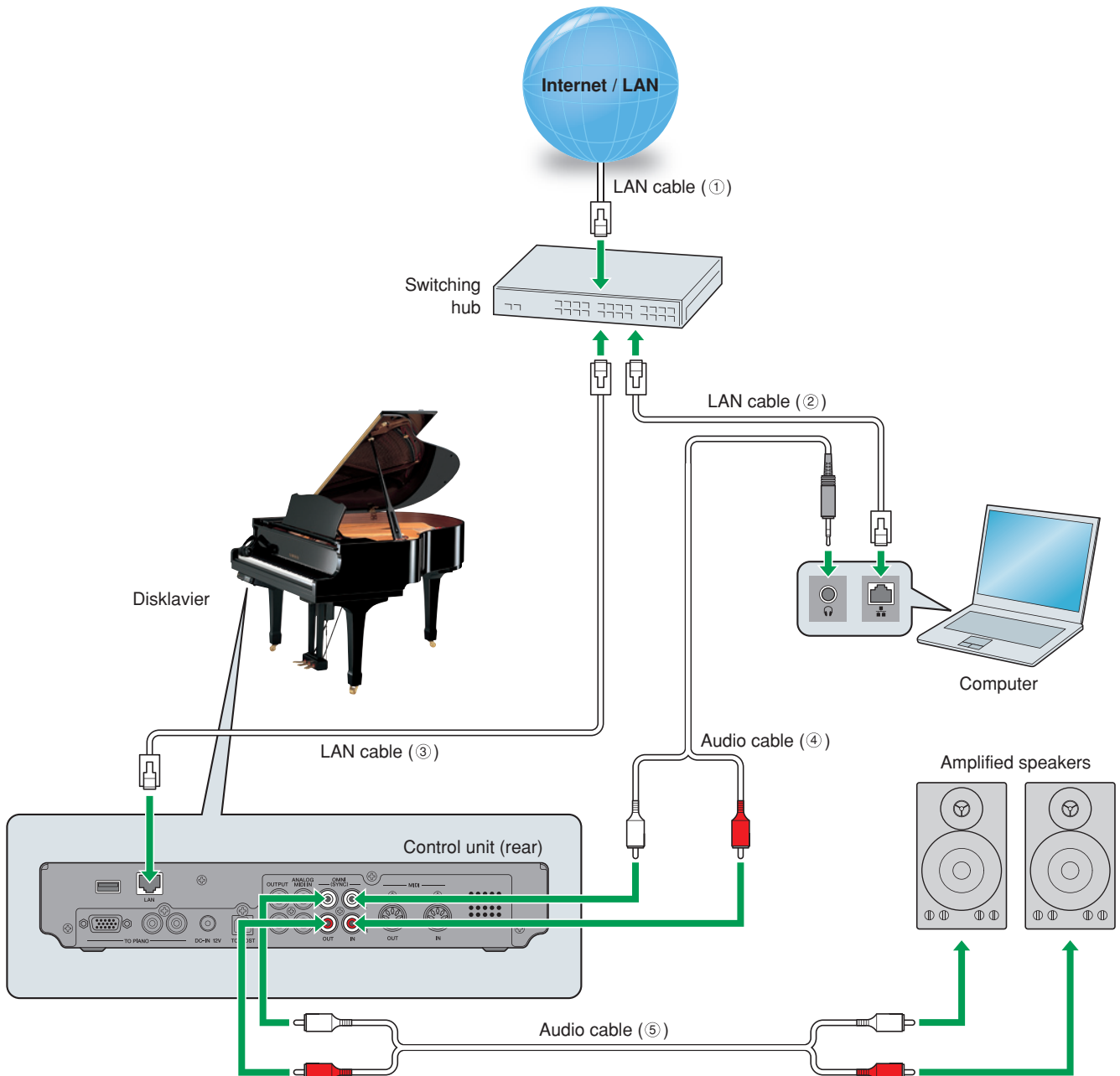

### Requirements (These items are NOT supplied with Disklavier.)

Equipment	
Computer (Windows or Mac)	1
Switching hub *1	1
Amplified speaker	2

Cables	From	To
LAN cable	1 Modem/router	Switching hub (1)
LAN cable	1 Switching hub	Computer (2)
LAN cable	1 Switching hub	Disklavier (3)
Audio cable A (stereo mini pin - 2 RCA males) *2	1 Computer	Disklavier (OMNI IN) (4)
Audio cable B (2 RCA males - 2 RCA males)	1 Disklavier (OMNI OUT) *3	Speaker (5)

\*1 You do not need the switching hub if your router has more than 2 empty LAN ports.

\*2 DO NOT use cables with impedance changers.

\*3 Change the OMNI OUT setting of your Disklavier to "Output." (Press [SETUP] > Select "Audio/O" > Select "OMNI OUT")

## Watching on Your TV with External Speakers

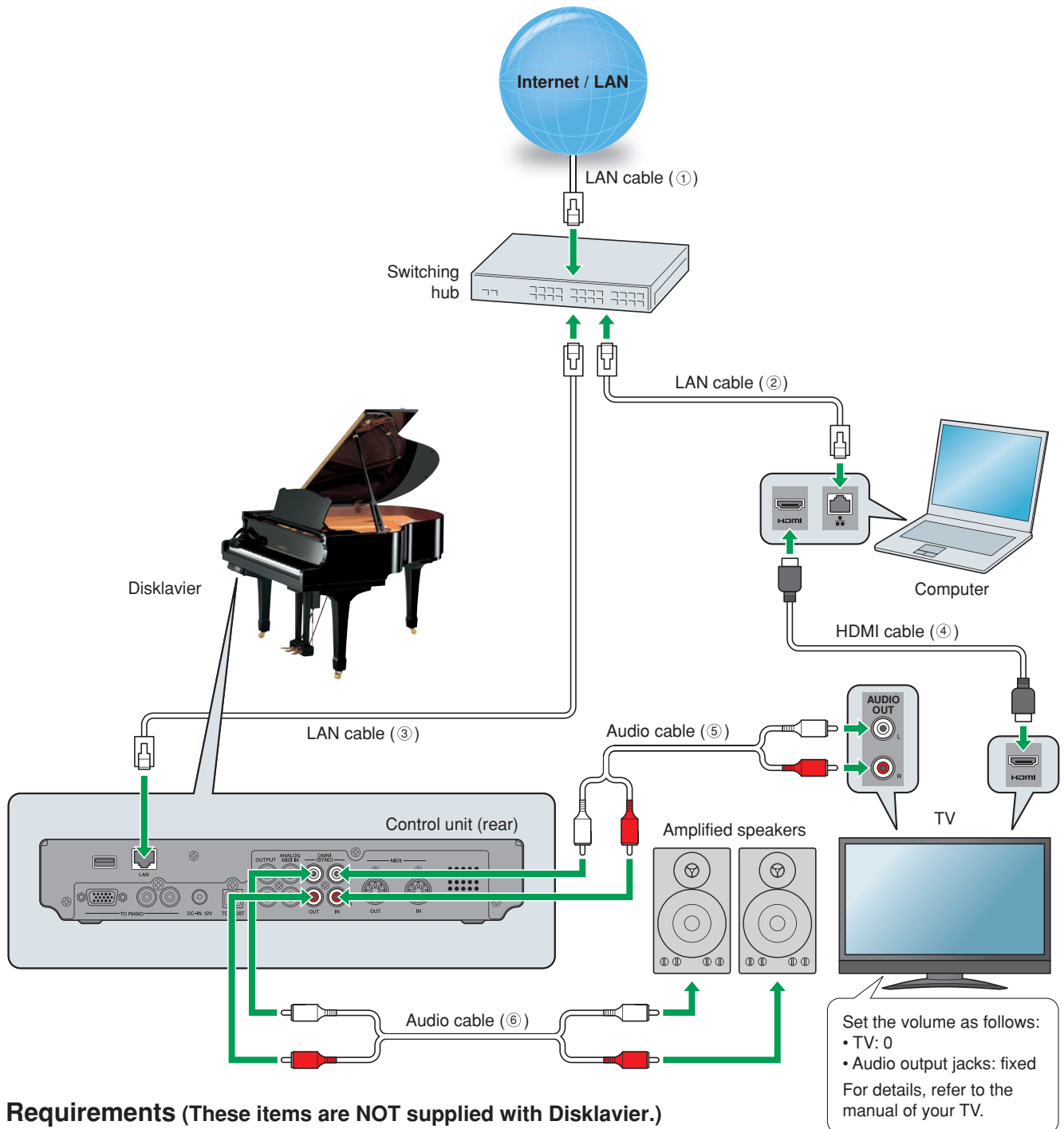

### Requirements (These items are NOT supplied with Disklavier.)

Equipment	Quantity
Computer (Windows or Mac)	1
Switching hub <sup>*1</sup>	1
TV (with HDMI input and audio output)	1
Amplified speaker	2

Cables	Quantity	From	To
LAN cable	1	Modem/router	Switching hub (1)
LAN cable	1	Switching hub	Computer (2)
HDMI cable	1	Switching hub	Disklavier (3)
Audio cable A (2 RCA males - 2 RCA males) <sup>*2</sup>	1	Computer	TV (4)
Audio cable B (2 RCA males - 2 RCA males)	1	TV	Disklavier (OMNI IN) (5)
Audio cable B (2 RCA males - 2 RCA males)	1	Disklavier (OMNI OUT) <sup>*3</sup>	Speaker (6)

<sup>\*1</sup> You do not need the switching hub if your router has more than 2 empty LAN ports.

<sup>\*2</sup> Cable required depends on your TV.

<sup>\*3</sup> Change the OMNI OUT setting of your Disklavier to "Output." (Press [SETUP] > Select "Audio/O" > Select "OMNI OUT")

# Connection Diagram (Advanced)

## Watching Video with High Quality Audio and External Monitor

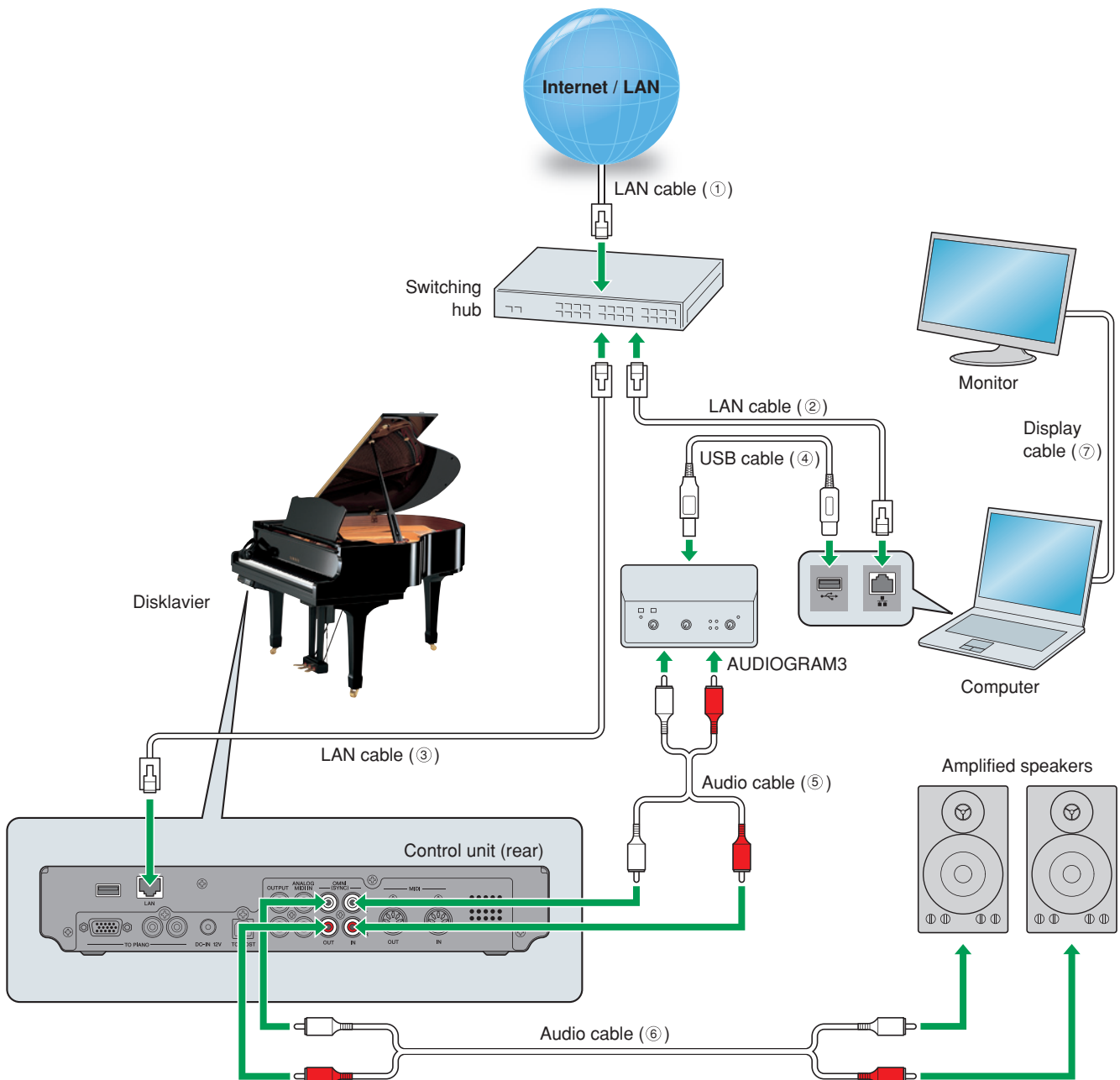

### Requirements (These items are NOT supplied with Disklavier.)

Equipment	Quantity
Computer (Windows or Mac)	1
Switching hub <sup>*1</sup>	1
Amplified speaker	2

Equipment	Quantity
Yamaha AUDIOGRAM3	1
Monitor	1

Cables	From	To
LAN cable	1 Modem/router	Switching hub (1)
LAN cable	1 Switching hub	Computer (2)
LAN cable	1 Switching hub	Disklavier (3)
USB cable	1 Computer	AUDIOGRAM3 (4)
Audio cable A (2 RCA males - 2 RCA males) <sup>*2</sup>	1 AUDIOGRAM3	Disklavier (OMNI IN) (5)
Audio cable B (2 RCA males - 2 RCA males)	1 Disklavier (OMNI OUT) <sup>*3</sup>	Speaker (6)
Display cable	1 Computer	Monitor (7)

<sup>\*1</sup> You do not need the switching hub if your router has more than 2 empty LAN ports.

<sup>\*2</sup> DO NOT use cables with impedance changers.

<sup>\*3</sup> Change the OMNI OUT setting of your Disklavier to "Output." (Press [SETUP] > Select "Audio/O" > Select "OMNI OUT")

# Appendix

## Windows 7 and 8 Audio Considerations

The “sound enhancements” provided by Windows 7 and 8 may be desirable for normal audio enjoyment. However, these enhancements cause problems for receiving broadcast or viewing on-demand content, because the *RemoteLive* technology requires discrete separation between the left and right audio channels. For this reason, you MUST disable all audio enhancements.

Please check the setting on your own computer. Location is different depending upon manufacturer. Here is an example setting.

Start > Desktop > Click the speaker icon > Enhancements > Disable all sound effects > Apply

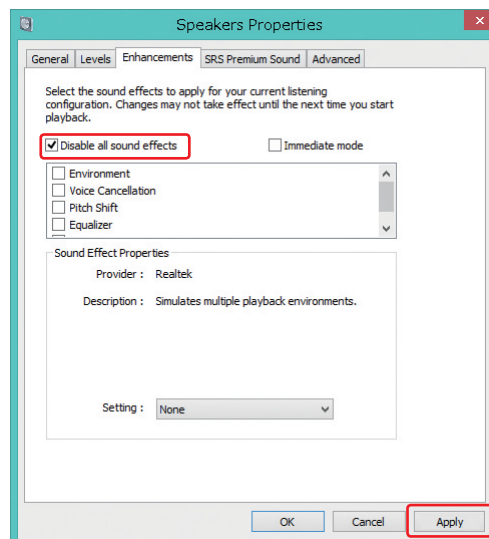
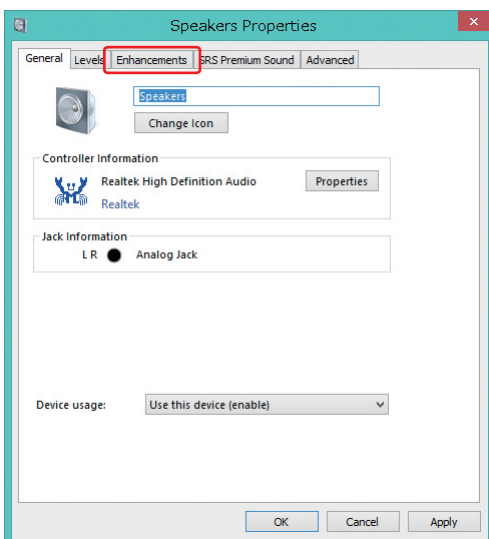
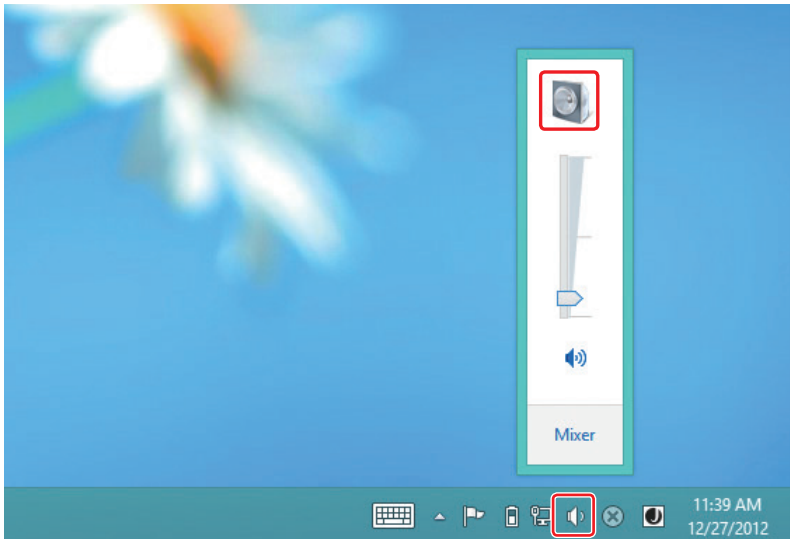

## Adjusting the Delay

When there is a disparity between the video or audio and the piano playback, you can adjust the piano playback or audio delay in order to match the video or audio.

### 1 Press [FUNC.] in the *RemoteLive* screen.

The *RemoteLive* function menu screen appears.



### 2 Select “Delay Adj.” with the cursor buttons ([◀] [▶] [▲] [▼]), then press [ENTER].



The Delay Adjust screen appears.



### 3 Select a desired option with the cursor buttons ([▲] [▼]), then press [+ / YES] and [- / NO] to change setting.



#### Audio & Piano Delay

You can adjust the delay of the piano playback and audio input through the OMNI IN jacks in order to match the video.

The delay time can be adjusted in a range of 0 ms to 500 ms. Increase this value to delay the piano playback and audio input.

#### Piano Delay

You can adjust the piano playback delay in order to match the audio from the device connected to the OUTPUT jacks.

The delay time can be adjusted in a range of 0 ms to 100 ms. Increase this value to delay the piano playback.

### 4 Press [ENTER] to complete the operation.



## Adjusting the Depth of the Sustain Pedal

[This function is not available on the DKC-850.]

You can adjust the depth of the sustain pedal.

### 1 Press [FUNC.] in the *RemoteLive* screen.

The *RemoteLive* function menu screen appears.



### 2 Select "Pedal Adj." with the cursor buttons ([◀] [▶] [▲] [▼]), then press [ENTER].



The Sustain Pedal Adjust screen appears.

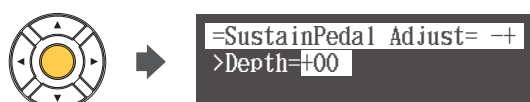

### 3 Press [+ / YES] and [- / NO] to change setting while listening to the piano playback.

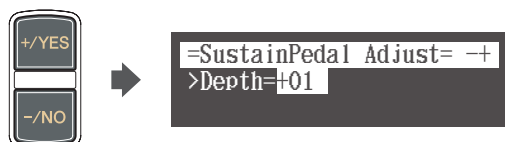

Increasing this value increases the effect of the sustain pedal, and decreasing this value decreases the effect of the sustain pedal.

The setting range varies depending on the model and its condition.

### 4 Press [ENTER] to complete the operation.



## Network Diagnostics

In some cases, it may be necessary to perform network diagnostics to determine the cause of problems. In these instances, follow the procedure below:

### 1 Press [FUNC.] in the *RemoteLive* screen.

The *RemoteLive* function menu screen appears.

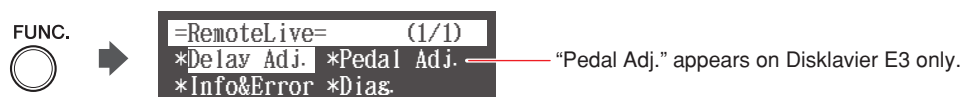

### 2 Select "Diag." with the cursor buttons ([◀] [▶] [▲] [▼]), then press [ENTER].



The Network Diagnostics screen appears and the diagnostics start.



When the diagnostics process is completed, the resulting error number and message is displayed.



### 3 Press [ENTER] to complete the operation.



#### Error Messages

Number	Message	Remedy
0000	Network OK.(0000)	No problem.
2011	Failed to connect.(2011) Check the cable.	Make sure that your Disklavier is connected properly to network with a network cable.
2012	Failed to connect.(2012) Check Network setting.	Make sure that the IP address of your Disklavier has been set correctly.
2013	Failed to connect.(2013) Check DNS setting.	Make sure that the DNS server address has been set correctly.
2014	Failed to connect.(2014) DNS is not available.	Make sure that the overall network settings (DHCP setting, DNS server address, IP address, subnet mask and gateway server address) on your Disklavier have been set correctly. If the problem persists, please contact your internet service provider.
2015	Failed to connect.(2015) Check Proxy setting.	Make sure that the proxy server has been set correctly.
2010	Failed to connect.(2010) Cannot connect to server.	The <i>RemoteLive</i> server may be temporarily down for maintenance. Please try again later.



## Checking the Broadcast Information and Error History

You can check the information about the broadcast and the error history.

### 1 Press [FUNC.] in the *RemoteLive* screen.

The *RemoteLive* function menu screen appears.



### 2 Select "Info&Error" with the cursor buttons ([◀] [▶] [▲] [▼]), then press [ENTER].



The Information screen appears.

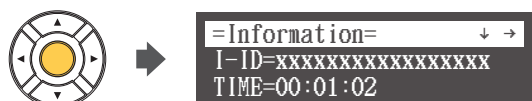

The Information screen includes the following information:

**I-ID:** ID of the broadcast Disklavier

**TIME:** Playing time of your Disklavier

**DATE:** Date and time when your Disklavier was played back

**S-ID:** ID of the piano performance data

**S-ID2:** ID of the piano performance data

### 3 To check the next information, press the cursor button ([▶]).

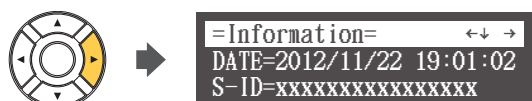

To return to the previous information, press the cursor button ([◀]).

### 4 Press [ENTER] to complete the operation.



# Troubleshooting

## ■ Error Messages

Number	Message	Point to be Checked	
2011	IDC/Diag error	Controller	Make sure that the Ethernet cable is securely connected into your Disklavier.
2014	IDC/Diag error	Controller	Make sure that the DHCP setting on your Disklavier is appropriate.
2015	IDC/Diag error	Controller	Make sure that you have entered the correct name and port number for the proxy server.
2014	IDC/Diag error	Controller	Make sure that you have entered the correct address of the gateway server.
2013, 2014	IDC/Diag error	Controller	Make sure that you have entered the correct address of the DNS server.
2012, 2014	IDC/Diag error	Controller	Contact Yamaha customer service.
–	NoSubscription	Controller	Confirm your subscription status on Yamaha MusicSoft.
2011	IDC/Diag error	Switching Hub	Make sure that the AC power cable is connected to the switching hub.
2011	IDC/Diag error	Switching Hub	Make sure that the switching hub is turned on.
2011	IDC/Diag error	Switching Hub	Make sure that the switching hub and Disklavier are connected with the Ethernet cable.
2014	IDC/Diag error	Switching Hub	Make sure that the switching hub and router are connected with the Ethernet cable.
2010, 2014	IDC/Diag error	Router	Make sure that the router setting is appropriate.
2014	IDC/Diag error	Router	Make sure that the AC power cable is connected to the router.
2014	IDC/Diag error	Router	Make sure that the router is turned on.
2014	IDC/Diag error	Router	Make sure that the router and switching hub are connected with the Ethernet cable.
2014	IDC/Diag error	Router	Make sure that your Disklavier obtains the IP address correctly from the DHCP server. Press [SETUP] on the remote control. Select “Network” in the setup menu, and then “Information”. You can confirm the IP address of your Disklavier.
2010, 2014	IDC/Diag error	Internet	Contact your ISP and confirm the contract for speed.
E901	Network Error	Internet	Contact your ISP and confirm the contract for speed.

## Piano

Symptom	Remedy
The Disklavier does not turn on.	Make sure that the AC power cable is securely connected to a suitable AC wall outlet.
Some notes drop out during playback.	Contact Yamaha customer service.
No sound is heard from the piano even though piano keys are moving.	Disengage the quiet mode. <b>Upright:</b> Set the center pedal to the original position. <b>Grand:</b> Push the [QUIET] switch on the control box. The light will go out.
Pedals are not moving. (except for Classic model)	Disengage the quiet mode. <b>Upright:</b> Set the center pedal to the original position. <b>Grand:</b> Push the [QUIET] switch on the control box. The light will go out.
The volume of the piano playback is too low.	See page 24 to adjust main volume.
The piano playback and audio is not synchronized with video streaming.	See page 30 to adjust the delay.
The piano playback is not synchronized with audio.	See page 30 to adjust the delay.
Pedal adjustment is inappropriate.	See page 31 to adjust the pedal.
Piano keys are not moving.	Make sure that the audio volume of computer is adequately turned up. Make sure that the surround system on your computer is TURNED OFF. Audio enhancements prevent DisklavierTV from working properly. Make sure that your computer is suitable for watching DisklavierTV contents. See page 20 to try viewing a test video. Make sure that the audio cable is correctly connected to the audio input jack. Make sure that the audio cable is firmly connected to the audio input jack on your computer. If symptom persists, connect the headphones to the jack and try listening to audio playback to confirm whether the jack is defective. Replace the audio cable. Reverse the left and right connection, and then check whether or not the piano keys are moving. Make sure that you are using the audio cable without impedance changer. In case you are using the USB audio interface, make sure that the USB audio driver is correctly installed on your computer. In case you are using the USB audio interface, make sure that USB audio is selected in the audio device setting on your computer. In case you are using the USB audio interface, make sure that the USB audio output volume is adequately turned up. In case you are using the USB audio interface, make sure that only the input from your computer is connected to the USB audio interface. If the input from any other device is connected, disconnect it or set its volume to 0. In case you are using the USB audio interface, make sure that the input and output on the USB audio interface are correctly connected.

## Controller

Symptom	Remedy
"RemoteLive" does not appear in the Internet menu.	<p>Make sure that your Disklavier firmware is the latest version (V3.50 or later). Holding [PLAY/PAUSE] on the control unit, press [ON/OFF]. The current version appears on the display.</p> <p>See page 13 and register as a Yamaha Online Member by creating your account on Yamaha MusicSoft.</p> <p>See page 17 and log into your account (enter e-mail and password registered on Yamaha MusicSoft) correctly.</p> <p>Make sure that your credit card information includes a United States mailing address.</p>
The remote control sometimes does not work.	Replace the battery of the remote control.

## Switching Hub

Symptom	Remedy
Failed to open the website on your browser.	<p>Make sure that the switching hub and router are connected with the Ethernet cable.</p> <p>Make sure that the switching hub and computer are connected with the Ethernet cable.</p>

## Computer

Symptom	Remedy
Video streaming does not start.	<p>Make sure that the operating system on your computer is suitable for watching DisklavierTV contents.</p> <p>Disable the firewall function on your computer. Be sure to enable it after you confirm that the symptom is improved.</p>
Video streaming is not smooth.	<p>Make sure that your computer is suitable for watching DisklavierTV contents. See page 20 to try viewing a test video.</p> <p>Disable the antivirus software on your computer. Be sure to enable it after you confirm that the symptom is improved.</p> <p>Disable the firewall function on your computer. Be sure to enable it after you confirm that the symptom is improved.</p> <p>Make sure that no other software except web browser is working.</p>
Failed to open the website on your browser.	<p>Make sure that the router is turned on.</p> <p>Make sure that the Ethernet cable is securely connected to the router.</p> <p>Make sure that the router and switching hub are connected with the Ethernet cable.</p> <p>Make sure that the router setting is appropriate.</p>
Failed to open the website on your browser.	Contact your ISP and confirm the contract for speed.
Video streaming is not smooth.	Check your bandwidth using the speed test site (e.g., <a href="http://www.speedtest.net">http://www.speedtest.net</a> ). We recommend over 4.0 Mbps for download speed. If the symptom persists, contact your ISP and confirm the contract for speed.
Piano playback is not stable due to unstable video streaming.	Check your bandwidth using the speed test site (e.g., <a href="http://www.speedtest.net">http://www.speedtest.net</a> ). We recommend over 4.0 Mbps for download speed. If the symptom persists, contact your ISP and confirm the contract for speed.

## Speakers

Symptom	Remedy
The audio from the speakers is not in sync with the video (audio is delayed).	See page 30 to adjust the delay. Check the audio delay specifications of the speakers.
The audio from the speakers is not in sync with the piano playback (audio is delayed).	See page 30 to adjust the delay. Check the audio delay specifications of the speakers.
No sound is heard from the speakers.	Make sure that the speakers are turned on. Make sure that the audio cable is firmly connected to the speaker. Make sure that the audio cable is not disconnected.
The speaker volume is too low.	Make sure that the speaker volume is adequately turned up. Make sure that the volume of the desired input is turned up. Make sure that you are using the audio cable without impedance changer.
No video sound is heard from the speakers connected to the OUTPUT jacks.	See page 25 to adjust audio balance. See page 24 to adjust main volume.
The left channel sound is heard more than once or seems to have an echo.	It is possible that you have the DisklavierTV website opened more than once. Make sure that ONLY the DisklavierTV website is opened. Reboot your computer.
No sound is heard from the speakers.	Make sure that the audio volume of computer is adequately turned up. Make sure that the audio cable is correctly connected to the audio input jack. Make sure that the USB audio driver is correctly installed on your computer. Make sure that USB audio is selected in the audio device setting on your computer. Make sure that the USB audio output volume is adequately turned up.
The speaker volume is too low.	Make sure that the audio volume of computer is adequately turned up. Make sure that you are using the audio cable without impedance changer. Replace the audio cable. In case you are using the USB audio interface, make sure that the USB audio output volume is adequately turned up.
Hissing sound is coming from the speakers.	Make sure that the surround system on your computer is TURNED OFF. Audio enhancements prevent DisklavierTV from working properly. Reverse the left and right connection, and then check the sound is appropriately output from the speakers. Replace the audio cable. Make sure that you are using the stereo audio cable.
Speaker output is unstable.	Make sure that the audio cable is firmly connected to the audio input jack on your computer. If symptom persists, connect the headphones to the jack and try listening to audio playback to confirm whether the jack is defective or not. Replace the audio cable.
Audio input through the USB audio input jack is being mixed into the speaker sound (in case you are using the USB audio interface).	Make sure that only the input from your computer is connected to the USB audio interface. If the input from any other device is connected, disconnect it or set its volume to 0.
No sound is output from the USB audio interface.	Make sure that the output on the USB audio interface are correctly connected to your Disklavier.

## External Monitor

Symptom	Remedy
The video image on the external monitor is not in sync with the audio from the speakers (video is delayed).	See page 30 to adjust the delay.
The video image on the external monitor is not in sync with the piano playback (video is delayed).	See page 30 to adjust the delay.
No video image is displayed on the external monitor.	Make sure that you have selected the desired input. Make sure that the display cable is connected.
Hissing sound is coming from the external monitor.	Make sure that the audio volume of the external monitor is 0.
The external monitor sleeps during playback.	Disable the power-saving setting on the external monitor.

### Contact Us

Phone: 866-430-2652

Online: [4wrd.it/D-TVsupport](http://4wrd.it/D-TVsupport)



YAMAHA CORPORATION  
P.O.Box 1, Hamamatsu, 430-8650 Japan

## Free Manuals Download Website

<http://myh66.com>

<http://usermanuals.us>

<http://www.somanuals.com>

<http://www.4manuals.cc>

<http://www.manual-lib.com>

<http://www.404manual.com>

<http://www.luxmanual.com>

<http://aubethermostatmanual.com>

Golf course search by state

<http://golfingnear.com>

Email search by domain

<http://emailbydomain.com>

Auto manuals search

<http://auto.somanuals.com>

TV manuals search

<http://tv.somanuals.com>