

User's Manual

CNPS9500 AT

Intel Socket 1156/775 CPU

Core i7

Core i5

Core 2 Quad

Core 2 Duo

Core 2 Extreme

Dual Core Pentium

Pentium D

Pentium 4

Celeron D

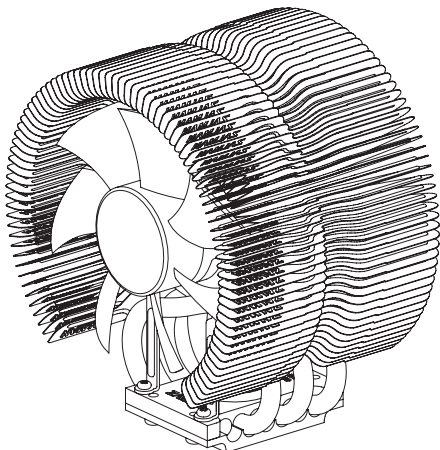

To ensure safe and easy installation,
please read the following precautions.

www.ZALMAN.com

1. Precautions

- 1) Use and keep product away from reach of children and pets.
- 2) Do not ingest the Thermal Grease, and avoid its contact with skin and eyes. If contact is made with skin, wash off with water. If ingested or irritation persists, seek medical attention.
- 3) To prevent possible injuries, gloves must be worn while handling this product.
- 4) Excessive force exerted on the fan may cause damage to the fan and/or system.
- 5) Avoid inserting objects or hands into the fan while it is in operation to prevent product damage and injuries.
- 6) Check the components list and condition of the product before installation. If any problem is found, contact the retailer to obtain a replacement.
- 7) Zalman Tech Co., Ltd. is not responsible for any damages due to overclocking.
- 8) During transportation of the system, the cooler must be removed. Zalman is not responsible for any damages that occur during the transport of a system.
- 9) Product design and specifications may be revised to improve quality and performance.

Disclaimer) Zalman Tech Co., Ltd. is not responsible for any damages due to external causes, including but not limited to, improper use, problems with electrical power, accident, neglect, alteration, repair, improper installation, or improper testing.

2. Specifications

Spec.		Model	CNPS9500 AT
Material			Pure Copper
Weight			530g
Dimensions			85(L) X 112(W) X 125(H)mm
Fan	Bearing-type		2 Ball-Bearing
	RPM		1,300rpm \pm 30% ~ 2,650rpm \pm 10%
	Noise Level		18.0dBA \pm 10% ~ 27.5dBA \pm 10%
	Input Voltage		12V
	Fan Function		PWM Control, Auto Restart

3. Components

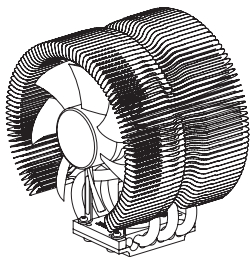

Cooler



Thermal Grease



User's Manual

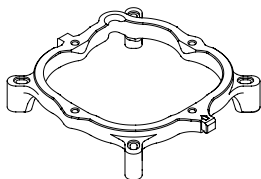

Clip Support

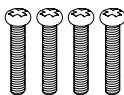

Clip Support Fixing Bolts



Washers

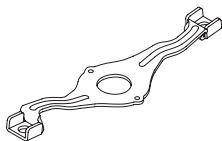

Clip



Clip Fixing Bolts



Nuts

4. Installation Requirements

1) Space Requirements

The cooler's installation requires unobstructed space with dimensions of 90mm (width), 115mm (length), 135mm (height), and the CPU as a central reference point. Please check if components such as ODDs and PSU protrude into the required space.

2) Air Guide Removal

Air guides on enclosures must be removed, before the cooler's installation, for they protrude into the cooler's required space.

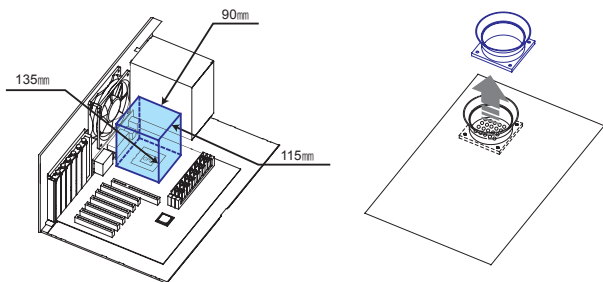

3) Cooler Orientation

It is recommended that the cooler be installed so that air flows from the cooler toward the enclosure's rear exhaust fan.

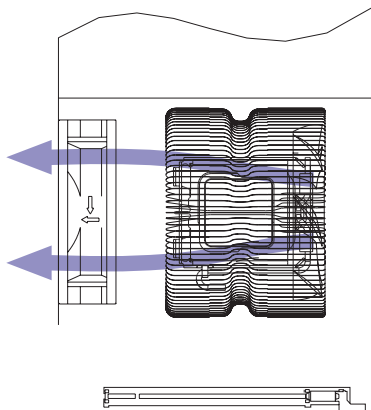

5. Installation

1) Clip Support Installation

Install the Clip Support to the motherboard according to the Socket-type.

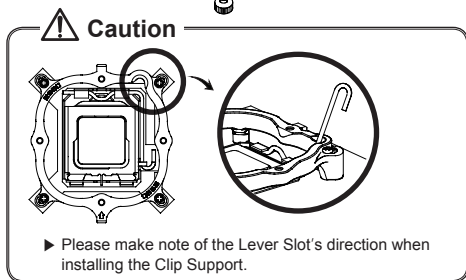
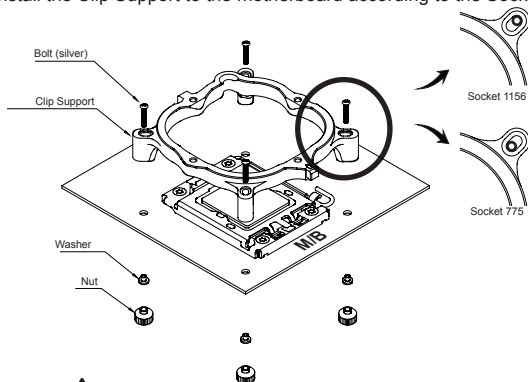

2) Thermal Grease Application

Clear off any particles or residue from the CPU's surface then spread (outwards from center) a thorough layer of Thermal Grease on the CPU and the base of the cooler.

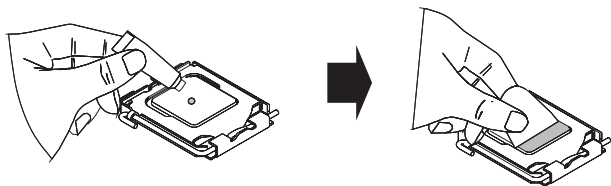

3) Cooler Installation

Insert the Clip Fixing Bolts to the Clip's Installation Holes and fasten with a screwdriver.

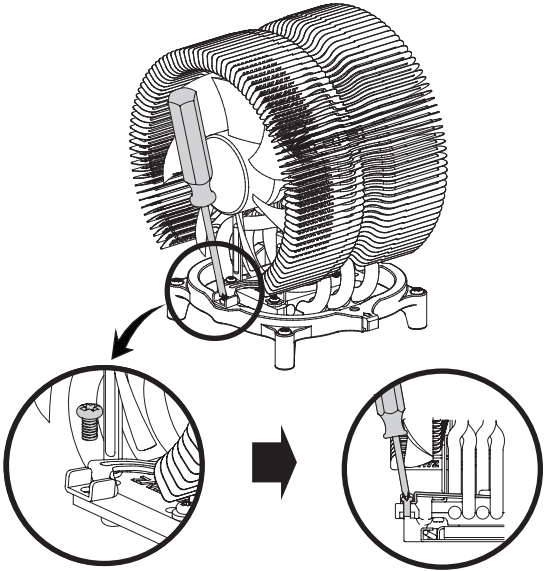

4) Fan Connector

Connect the Fan Connector to the motherboard's PWM fan header (4-Pin).

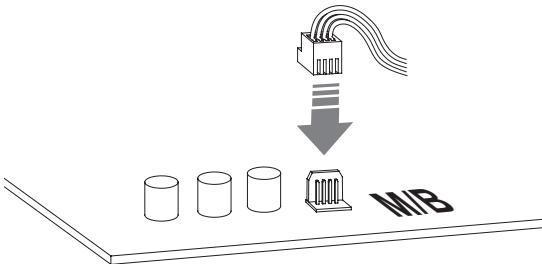

GS1000 / GS1000SE

- E-ATX / Standard ATX / microATX Compatible
 - * Supports Intel Dual Xeon server motherboards
- UP to 6 Hot Swap HDD Bays
 - * GS1000(3 Standard / 3 Optional)
 - * GS1000 SE(Optional)
- Tool-Free HDD Installation
- Airflow Optimized Design
- Vibration Absorbing HDD Dampers and Feet
- The World's First Roller Rails for Smooth & Easy PSU Installation
- Cable Compartment Behind the Motherboard for Cable Management
- Dedicated Fan Compartment for Fanless PSU Users
- Up to a Total of 8 HDD Bays
 - * 2 Adaptors & Bezels included for use of two 5.25" bays as 3.5" Internal(HDD)/ External(FDD) Bays



GT1000

- High-End Gaming Enclosure Built with Sturdy All Aluminum Panels
- Three Tool-Free Hinged Magnetic Panels (2 Left, 1 Right) for Easy Installation and Access to Components
- Tool-Free Installation of Disk Drives, Fan Controlles, Audio Interfaces etc.
- Accommodates up to 6 Hard Drives
- Luxurious and Cool Aesthetics.
- Color Option: Black (Red LED Fans), Titanium (Blue LED Panel).



For more information, please visit our website.

Free Manuals Download Website

<http://myh66.com>

<http://usermanuals.us>

<http://www.somanuals.com>

<http://www.4manuals.cc>

<http://www.manual-lib.com>

<http://www.404manual.com>

<http://www.luxmanual.com>

<http://aubethermostatmanual.com>

Golf course search by state

<http://golfingnear.com>

Email search by domain

<http://emailbydomain.com>

Auto manuals search

<http://auto.somanuals.com>

TV manuals search

<http://tv.somanuals.com>