

User's Manual

(English Edition)

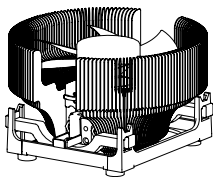

Intel Pentium 4
Socket 478 CPU

AMD Athlon / Duron / Athlon XP
Socket 462 CPU

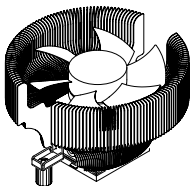
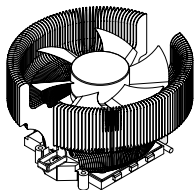

AMD Athlon 64
Socket 754 CPU

CNPS7000A

*** Please read before installation**

1. Features

- 1) Does not generate noise or vibration in Silent Mode.
- 2) Pure copper and/or pure aluminum base materials ensure excellent heat dissipation.
- 3) Intel Pentium 4 (Socket478), AMD Athlon/Duron/Athlon XP (Socket462), Athlon 64 (Socket754) compatible design for broad compatibility.
- 4) 92mm fan inside the FHS maximizes airflow and makes installation easier.
- 5) Adjustable fan speed controller (FAN MATE 1) enables control of noise and fan performance.

* Fan should be set to Normal Mode if overclocking.

* Zalman Tech. Co., Ltd. is not responsible for any damage resulting from CPU OVERCLOCKING.

2. Specifications

1) FHS (Flower HeatSink)

Spec.		Model	CNPS7000A-AIC	CNPS7000A-Cu
Weight (g)			445	773 ^{b)}
T.R. (°C/W)	Silent Mode		0.29	0.27
	Normal Mode		0.22	0.20
Dimensions (mm)			109(L) X 109(W) X 62(H)	
Dissipation Area (Cm ²)			3170	

2) Fan

- Bearing Type : 2-Ball
- Rotational Speed : 1350RPM \pm 10 % (Silent Mode)
2400RPM \pm 10 % (Normal Mode)
- Noise Level : 20dB \pm 10% (Silent Mode) - measured at 1m distance from noise source
25dB \pm 10% (Normal Mode) - measured at 1m distance from noise source

3) FAN MATE 1

- Output Voltage : 5V - 11V \pm 2 %
- Allowable Power : 6W or lower

NOTE1) The maximum weight for the cooler is specified as 450g/450g/300g for socket 478/754/462 respectively. Special care should be taken when moving a computer equipped with a cooler which exceeds the relevant weight limit. Zalman Tech is not responsible for any damage that occurs when moving a computer.

3. Exploded View

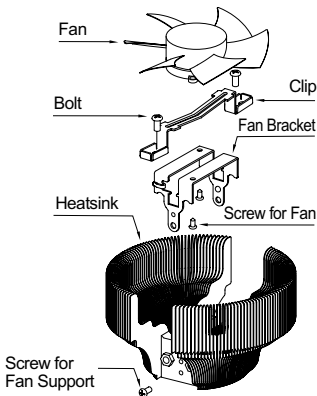

4. Patents

- ❖ Korean Patent Application No. 00-54635
- ❖ Korean Design Application Nos. 02-17470, 02-25208, 02-25209, etc.
- ❖ Patent Applications pending in over 20 nations around the world, including USA, EU, and Japan

5. Cautions During Installation

- 1) If excessive force is exerted on the fan, it may malfunction and result in damage to the product and/or the computer.
- 2) Do not put your finger into the fan while it is running.
- 3) Keep the product away from children.
- 4) Zalman Tech. Co., Ltd. is not responsible for any problems arising from using the product outside its intended purpose.
- 5) The exposed core of a Socket 462 CPU can be cracked if proper care is not taken. Read the "Installation" section thoroughly before installing.
- 6) Zalman Tech. Co., Ltd. is not responsible for any problems arising from using CNPS7000A on a Socket 462 CPU.

5. Components

1) Common Components

- 1 FHS Assembly (CNPS7000A-CU/ALCU)
- 2 Four Bolts - For fastening the Clip
- 3 Thermal Grease
- 4 Adjustable Fan Speed Controller (FAN MATE 1)
- 5 User's Manual

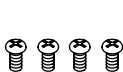
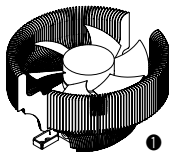

2



3

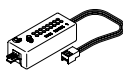

4



5

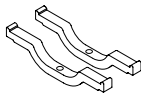

6

2) Components for Intel Pentium 4(Socket 478)

- 6 Two (2) Clip Supports - For Socket 478

3) Components for AMD Athlon / Athlon XP(Socket 462)

- 7 One(1) A - Type(blue) Clip Supports for AMD Socket 462
- 8 One(1) B - Type(white) Clip Supports for AMD Socket 462
- 9 Four Bolts - For Fastening the Clip Supports
- 10 One Set of Washers



7



8



9

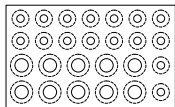

10

4) Components for AMD Athlon 64(Socket 754)

- 11 Two Nipples
- 12 One Blackplate
- 13 Use Big Hole Washer at Component 10



11

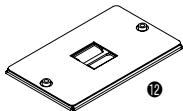

12

6. Compatible CPU Types

1) INTEL Pentium 4 - Socket 478

All current speeds of Pentium 4 Socket 478 CPUs

For CPUs with higher clock speeds than 3.2GHz, please refer to our website (www.zalmanusa.com).

Caution)

- ① As shown in Figure 2 a motherboard that is not compliant with the "10.2mm motherboard component height restriction" standard, introduced by Intel, may create interference between components and the clip. Please do not install the CNPS7000A when this interference is observed.
- ② No components higher than 3.9cm should be present within 5.5cm radius from the center of the CPU to install this product.

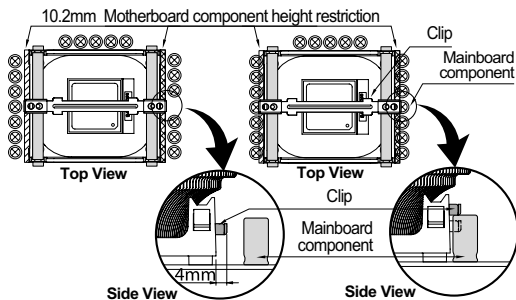

Figure 1 (O)

Figure 2 (X)

2) AMD Athlon/Duron/Athlon XP - Socket 462

All CPUs conforming to Socket 462 platform

Caution)

- ① This product requires "Heatsink Attach Holes" around CPU Socket as shown on the right figure.
- ② No components higher than 3.9cm should be present within 5.5cm radius from the center of the CPU to install this product.
- ③ This product can not be installed if any Motherboard component (capacitor) taller than 1.5cm is located under the clip.
- ④ For more information, refer to "Compatible Motherboard List" at our website (www.zalmanusa.com).

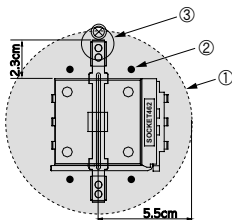

3) AMD Athlon 64 - Socket 754

Visit our website (www.zalmanusa.com) for a list of compatible CPUs after Athlon 64 is officially released.

7. Installation (INTEL Pentium 4-478)

1) Apply Thermal Grease

Spread thermal grease thinly and evenly over the CPU core.

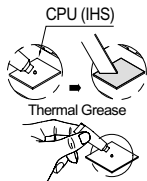

2) Install Clip Support

Install the two clip supports at both sides of the retention guide as shown on the right.

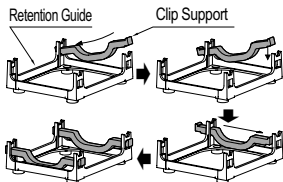

3) Insert Bolts

Insert the bolts into the inner holes on the clip.

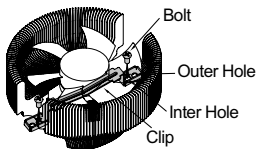

4) Fasten Bolts

Place the FHS on the center of the CPU. Screw in both bolts in an alternating fashion until they are completely tightened.

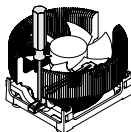

5) Supply Power

Connect FAN MATE 1 between the motherboard and the fan.

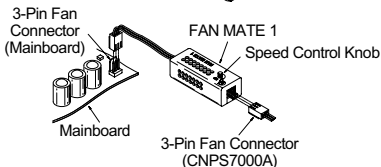

8. Installation- AMD (Athlon/Duron/Athlon XP-462)

1) Install Clip Support

Install the socket 462 Clip Supports as shown on the right.

Ensure to install A-Type clip support(Blue) by the Lever.

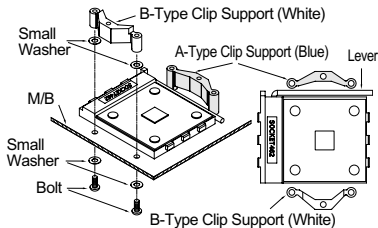

2) Apply Thermal Grease

Spread thermal grease thinly and evenly over the CPU core.

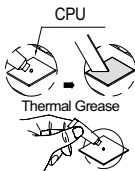

3) Insert Bolts

Insert the bolts into the inner holes on the clip.

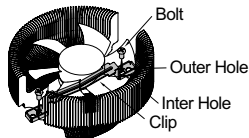

4) Fasten Bolts

Place the FHS on the center of the CPU. Screw in both bolts in an alternating fashion until they are completely tightened.

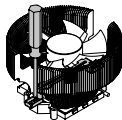

5) Supply Power

Connect FAN MATE 1 between the motherboard and the fan.

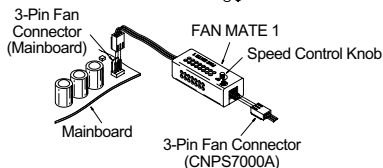

9. Installation- AMD (Athlon 64-754)

1) Fasten Nipples

Locate the backplate on the bottom of the motherboard under the CPU socket, then fasten the nipples as shown on the right.

* When installing CNPS7000A on Athlon 64, Retention Frame is not needed.

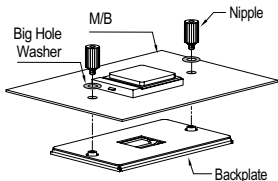

2) Apply Thermal Grease

Spread thermal grease thinly and evenly over the CPU core.

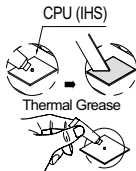

3) Insert Bolts

Insert the bolts into the outer holes on the clip.

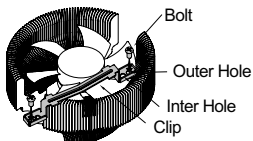

4) Fasten Bolts

Place the FHS on the center of the CPU. Screw in both bolts in an alternating fashion until they are completely tightened.



5) Supply Power

Connect FAN MATE 1 between the motherboard and the fan.

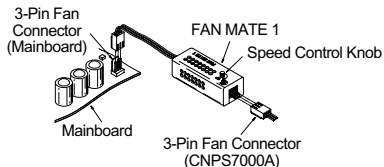

10. Notes on Usage

1) Checking CPU Compatibility & Using FAN MATE 1

Read "Compatible CPU Types" on page 4 to confirm that your CPU is compatible before using the CPU cooler. The speed control knob on FAN MATE 1 can be turned to set the fan speed. When it is turned counter-clockwise, the fan operates in Silent Mode at its minimum speed.

NOTE) FAN MATE 1 has been specifically designed to be used with the fan included in this product. Zalman Tech. Co., Ltd. is not responsible for any damage caused to systems or CPUs by using FAN MATE 1 with other types of fans.

2) Cautions During Booting

When booting the computer, it may automatically power down after an alarm sound by a system monitoring program to indicate that the CPU fan is rotating slowly. If this happens, turn the speed control knob fully clockwise to increase the fan speed. Then set 'CPU Fan Detected' to 'Disabled' in the BIOS settings, or set the slowest rotational speed of the CPU fan in the system monitoring program to less than or equal to 1300 RPM. Now the fan can be set back to the silent mode by turning the knob counter clockwise.

NOTE) Some motherboards do not boot if the rotational speed of the CPU fan below a certain number of RPM. If the BIOS settings are updated, Silent Mode can be used. For more information on updating your BIOS, please refer to your motherboard manufacturer's web site. Disabling of CPU fan speed detection in BIOS settings does not effect computer performance.

3) Creating a Complete Noiseless System

Use the following Zalman products to achieve stable and silent operation of your computer : Noiseless Power Supply, CNPS series CPU Cooler, Fanless Coolers for Northbridge Chipset & Video Card, and Noiseless Fan.

* For more info on these products, visit our website at www.zalman.co.kr.

11. Thermal Resistance and Noise

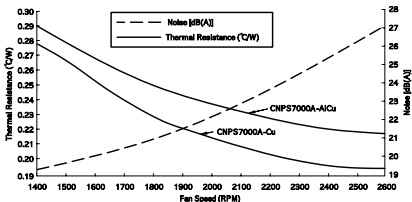

Free Manuals Download Website

<http://myh66.com>

<http://usermanuals.us>

<http://www.somanuals.com>

<http://www.4manuals.cc>

<http://www.manual-lib.com>

<http://www.404manual.com>

<http://www.luxmanual.com>

<http://aubethermostatmanual.com>

Golf course search by state

<http://golfingnear.com>

Email search by domain

<http://emailbydomain.com>

Auto manuals search

<http://auto.somanuals.com>

TV manuals search

<http://tv.somanuals.com>