

ZANUSSI

 Electrolux

TUMBLE DRYER ZDB 5377 W

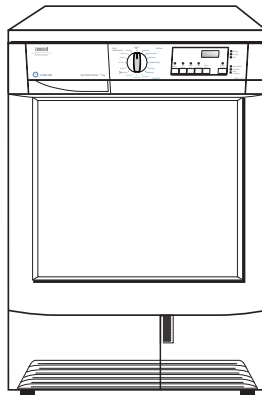

 **Unpacking:** see page 17



Important Safety Information

It is most important that this instruction book should be retained with the appliance for future reference. Should the appliance be sold or transferred to another owner, or should you move house and leave the appliance, always ensure that the book is supplied with the appliance in order that the new owner can get to know the functioning of the appliance and the relevant warnings.

These warnings have been provided in the interest of your safety. You **MUST** read them carefully before installing or using the appliance.

Installation

- This appliance is heavy. Care should be taken when moving it.
- It is dangerous to alter the specifications or attempt to modify this product in any way.
- Any electrical work required to install this appliance should be carried out by a qualified electrician or competent person.
- Care must be taken to ensure that the appliance does not stand on the electrical supply cable.
- If the machine is situated on a carpeted floor, please adjust the feet in order to allow air to circulate freely.
- If the tumble dryer is placed on top of a washing machine, it is compulsory to use the stacking kit (Available as an accessory).

Child Safety

- This appliance is designed to be operated by adults. Children should not be allowed to tamper with the controls or play with the product.
- Pets and children have been known to climb into tumble dryers. Please check your drum before use.
- Keep all packaging well away for children.

Use

- Do not overload the appliance (see programme chart).
- Clothes which are dripping wet should not be placed in the dryer.
- As some bulky items such as duvets and eiderdowns should be dried in large commercial machines because of their bulk, check with the manufacturer of the item if it is suitable for drying in a domestic machine, even if the dry weight of the item is within the limit advised.
- Please make sure that no gas lighters or matches have accidentally been left in pockets of garments to be loaded into appliance.

- **Danger of explosion:** Never tumble dry items that have been in contact with inflammable solvents (petrol, methylated spirits, dry cleaning fluid and the like). As these substance are volatile, they could cause an explosion. Only tumble dry items washed with water.
- Risk of fire: items that have been spotted or soaked with vegetable or cooking oil constitute a fire hazard and should not be placed in the tumble dryer.
- If you have washed your laundry with stain remover you must execute an extra rinse cycle before loading your tumble dryer.
- In order to avoid danger of fires caused by excessive drying, do not use appliance to dry the following items:
Cushions, quilts and the like (these items accumulate heat).
Items containing rubber foam or materials similar to rubber foam.
- Leave the door slightly ajar when the appliance is not being used. This will allow the seal to be preserved.
- Clean fluff filters after using the tumble dryer. To prevent fire risks, do not use the appliance if the fluff filters are damaged.
- Do not allow fluff to accumulate around the dryer.
- Under no circumstances should you attempt to repair the machine yourself. Repairs carried out by inexperienced persons may cause injury or serious malfunctioning. Contact your local Service Force Centre. Always insist on genuine Zanussi spare parts.

Contents

For the User

Important Safety Information 2

- Installation
- Child Safety
- Use

Your New Tumble Dryer 4

Description of the Appliance 4

The Control Panel 5

- Programme/Time Selector Dial 5
- Door Release Button 5
- No Buzzer Button 5
- Quick Dry Button 5
- Low Temperature Button 5
- Delay Start Button 6
- Display 6-7
- Start/Pause Button 7
- Indicator Lights 7

Programme Chart 8

Operating Sequence 9

Hints & Tips on Drying 10

Maintenance and Cleaning 11

- External cleaning 11
- Cleaning the door 11
- Cleaning the filters 11
- Cleaning the condenser unit 11-12
- Emptying the water reservoir 12
- Cleaning the drum 12
- Cleaning the air intake grille 12

Something Not Working 13

Service and Spare Parts 13

Customer Care 13

Guarantee Conditions 14

For the Installer

Installation Instructions 15

Technical Specifications 15

Adjusting the level of conductivity 16

- Unpacking 17
- Positioning 17
- Stacking kit (optional accessory) 17
- Door reversal 17
- Electrical connection 17-18

Guide to use the Instruction Book

The following symbols will be found in the text to guide you throughout the instructions:



Safety instructions



Hints and tips



Environmental information

Your New Tumble Dryer

This tumble dryer will give your wash that soft, relaxed feel whatever the weather.

Extremely high quality standards both during development and manufacturing guarantee a long service life for your appliance.

Maximum economy in the operation of your dryer is achieved through very frugal electricity consumption and short drying times.

Energy saving tips

To save energy we recommend that you follow these hints:

- Try to load the maximum capacity of the machine as small loads are **uneconomical**.
- Always load well spun laundry. The higher the spin speed, the lower the electricity consumption and the shorter the drying times.
- Do not over-dry laundry, this avoids creasing and saves energy.
- Clean the filters regularly to avoid excessive drying times and high electricity consumption.
- Ventilate the room well. The room temperature should not exceed +35°C during drying.



In the interest of the environment

- Materials marked with the symbol  are recyclable.
- Check with your local Council or Environmental Health Office to see if there are facilities in your area for re-cycling this appliance.

- When the appliance is to be scrapped, cut off the power supply cable and make the door closing device unusable to prevent young children from being trapped inside.
- Help to keep your country tidy - use authorised disposal sites for your old appliance.

How do we help to protect the environment? We use recycled paper!

Old appliance

The symbol  on the product or on its packaging indicates that this product may not be treated as household waste. Instead it shall be handed over to the applicable collection point for the recycling of electrical and electronic equipment. By ensuring this product is disposed of correctly, you will help prevent potential negative consequences for the environment and human health, which could otherwise be caused by inappropriate waste handling of this product. For more detailed information about recycling of this product, please contact your local city office, your household waste disposal service or the shop where you purchased the product.

Description of the Appliance

- 1 Control panel
- 2 Water reservoir
- 3 Drum light
- 4 Fluff filters
- 5 Rating Plate
- 6 Condenser unit
- 7 Adjustable feet

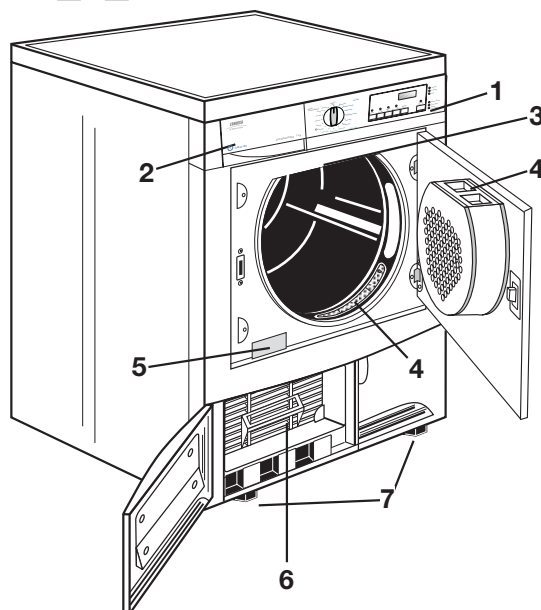

The Control Panel

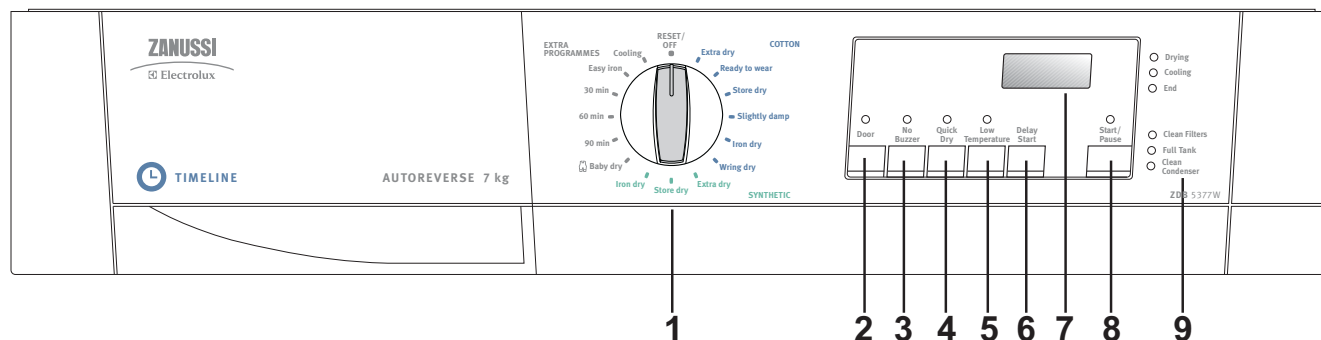

1 Programme/Time Selector Dial

Allows you to select electronically controlled or time controlled drying.

Turn the dial to the required programme or time.

Electronically controlled drying (automatic)

The appliance runs these programmes with the help of probes which detect the degree of dampness of the laundry.

Simply select the programme according to the type of laundry and degree of drying required.

Time controlled drying

This can be used to finish off drying if necessary. Select the 90 or 60 minute programme for cottons or the 30 minute programme for synthetics.

To cancel a programme which is running, turn the programme selector dial to **“RESET/OFF”**.

At the end of drying, turn the selector dial to **“RESET/OFF”** to switch the machine off before removing the laundry.

2 DOOR RELEASE Button

Press this button to open the door. The light above the button will light up.

Opening the door by means of this button is possible only if the tumble dryer is on (programme selector dial set to a programme or drying time).

If you open the door during a programme, in order to restart the programme you must press the START/PAUSE button again after having closed the door.

3 No BUZZER Button

A buzzer sounds

- when selecting the programme
- when depressing the buttons
- when an incorrect option selection is made
- when the programme selector dial is turned to another position during the programme or when you depress an option button during the cycle
- at the end of the programme and during the anticrease phase
- when the water reservoir is full
- if the machine is not working correctly
- when the small door at the bottom is open.

By depressing the button the acoustic signal is switched off.

The corresponding light comes on.

4 QUICK DRY Button

By depressing this button the drying time is reduced in the following COTTON programmes:

- EXTRA DRY
- READY TO WEAR
- STORE DRY

The corresponding pilot light comes on. This option **cannot** be selected with LOW TEMPERATURE function.

5 LOW TEMPERATURE Button

Pressing this button allows drying to be performed at a lower temperature, for delicate items.

The corresponding pilot light comes on.

This option can also be used for time controlled drying.

This option **cannot** be selected with QUICK DRY.

6 DELAY START button

This button allows you to delay the starting of the programme by 12 hours max.

This option must be selected **after** having selected the programme and **before** pressing START/PAUSE to start the programme.

Every time the button is pressed, the time is increased by 30 minutes, until the display shows a delay of “2 hours”. After this, the delay is displayed hour by hour.

The minutes or hours of delay that have been selected are displayed for 2 seconds, then the display shows the duration of the previously selected programme.

The countdown begins after you have pressed the START/PAUSE button.

To cancel the delay time press the START/PAUSE button and after press the DELAY START button until the display indicates \mathcal{D} . Then press the START/PAUSE button again.

When the delay is cancelled, the display shows \mathcal{D} and after the duration of the programme.

During the delayed start, it is not possible to change the programme or the delay time that have been selected. To do this, you must first switch off the machine by setting the programme selector dial to “RESET/OFF”. Select the new programme, the options and the delayed start, then press the START/PAUSE button.

During the delayed start, to cancel or change functions that have been selected, simply set the appliance to PAUSE. Once you perform the desired operation, press once again the START/PAUSE button.

If you wish to add more laundry while the machine is performing the countdown, simply open the door. When you close the door, press the START/PAUSE button again to cause the countdown to be resumed.

7 DISPLAY

The display shows the following information:

- duration of selected programme
- delayed start
- end of programme
- incorrect option selection
- alarm code

• Duration of selected programme

After you have selected the programme, its duration (in hours and minutes) appears on the display. It is calculated automatically on the basis of the maximum load accepted for each type of fabric and of the required degree of drying.



When the programme starts, the remaining time is displayed every 5 minutes.

• Delayed start

If you have selected a delay time by means of the relevant button, the display shows it for 2 seconds; then it shows the duration of the previously selected programme.

The countdown is displayed every 30 minutes until it displays “90 minutes” and then hour by hour.



• End of programme

A **flashing zero** indicates the end of the programme and it is displayed after the “anti-creasing” phase.

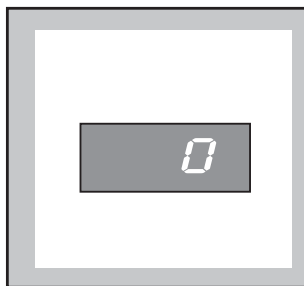

- **Incorrect option selection**

If you select an option that is not compatible with the programme you have selected, the display shows *Err* (error).



This code will reappear during the execution of the programme if you press one of the option buttons or turn the programme selector.

- **Alarm code**

In the case of a functional problem, the display shows an alarm code (e.g. *E21*). See page 13 for more detailed information.



8 START/PAUSE button

Press this button to start the dryer after having selected the programme and the options. The relevant light will stop flashing. If you have chosen a delayed start, the machine will begin the countdown.

If the door of the appliance or the small door at the bottom is opened while the programme is running, this button must be pressed again after closing the door in order to restart the programme from the point at which it was interrupted.

This button must also be depressed after a power failure and after having re-inserted the water reservoir, if it has been emptied in the middle of a programme after lighting up of the “FULL TANK” light.

In both cases the light of the Start/Pause button flashes to remind you that the start button needs to be pressed again.

Important!

After emptying the water reservoir following a full tank light, there may be a short delay before the machine will re-start to allow the system to re set.

9 Indicator Lights

These lights indicate the following functions:

“DRYING” light

This light indicates that the appliance is in the drying phase.

“COOLING” light

This light indicates that the appliance is in the cooling phase. At the end of drying, there is a 10 minute cooling phase to cool the laundry.

“END” light

This light is on at the end of the cooling phase, during the anti-creasing phase and at the end of the programme.

“CLEAN FILTERS” light

This light illuminates at the end of the programme to remind you that the filters must be cleaned.

“FULL TANK” light

This light comes on at the end of the programme to remind you that the water reservoir must be emptied out. If this light illuminates during a programme this means that the water reservoir is full. The buzzer sounds, the programme stops, the light of the Start/Pause button flashes.

“CLEAN CONDENSER” light

It comes on every 80 cycles to remind you that the condenser must be cleaned.

Programme Chart

Automatic drying (electronic programmes)

Type of laundry	Degree of drying required	Max-load ⁽¹⁾	Programme
COTTON	Extra dry	7 kg	EXTRA DRY
	Ready to wear	7 kg	READY TO WEAR
	Store dry	7 kg	STORE DRY(*)
	Slightly damp	7 kg	SLIGHTLY DAMP
	Iron dry	7 kg	IRON DRY(*)
	Wring dry	7 kg	WRING DRY
SYNTHETICS	Extra dry	3.5 kg	EXTRA DRY
	Store dry	3.5 kg	STORE DRY(*)
	Iron dry	3.5 kg	IRON DRY
JUMPERS	Baby dry	2 kg	BABY DRY
Jackets, shirts, chemises.	Easy iron	1 kg	EASY IRON

(*) According to IEC 61121 Standards.

- Baby Dry cycle  is a special programme for jumpers to be dried "READY TO WEAR".

Time controlled drying

Type of laundry	Drying time	Max-load ⁽¹⁾	Programme selector dial position
COTTON	90'	7 kg	90 min
COTTON	60'	7 kg	60 min
SYNTHETICS	30'	3.5 kg	30 min

(1) Never overfill the drum (do not load large quilts, for example).

Drying times vary according to:

- The type of laundry
- The size of the load
- The degree of spinning prior to drying.
- The degree of dryness required

Cooling

This position on the programme selector dial can be used to freshen the laundry (e.g. to remove a persistent odour of moth-balls).

Load

It is often difficult to estimate the weight of items to be dried. We therefore recommend that you adopt the following guidelines:

- **cotton, linen:** drum full but not too tightly packed;
- **synthetics:** drum no more than half full;
- **delicate fabrics:** drum no more than one third full.

Operating Sequence

Before using your tumble dryer for the first time, we recommend you to place a few damp cloths inside the appliance and dry for 30 minutes. There may be dust inside a brand new tumble dryer.

Drying

1. Connect the appliance.
2. Open the door (see picture).

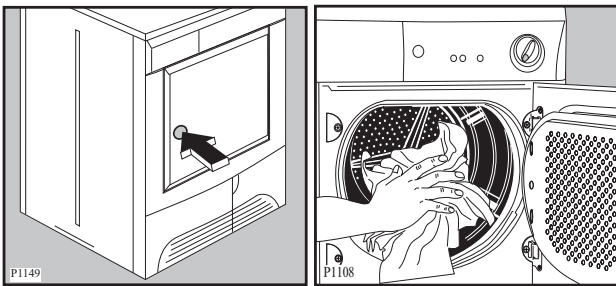

3. Load the items one at a time, shaking them out loosely.
4. Close the door. Please check the laundry does not get caught between the door and filter.
5. Select the drying programme or time. The lights DRYING, COOLING and END come on. The light of the START/PAUSE button flashes and the display shows the duration of the programme.
6. If required, press the LOW TEMPERATURE button and/or the NO BUZZER button or the QUICK DRY button.
7. Select the DELAY START if required. The selected delay appears on the display for 2 seconds, then the duration of the selected programme is displayed.
8. Press the START/PAUSE button: the corresponding light stops flashing and drying starts. Only the DRYING light stays lit. If you have selected the DELAY START, the machine begins its countdown.

The drum turns alternately in both directions during drying.

All drying programmes end with a 10 minute cooling phase (light COOLING is on).

You may remove the laundry after this phase.

The END, CLEAN FILTERS and FULL TANK lights illuminate. The display shows a static zero and the buzzer sounds to indicate the end of the cycle.

9. If the laundry is not removed at the end of the cycle, the dryer performs an **anti-creasing** phase (duration: 30 minutes maximum).

If you do not remove the laundry, the dryer will

stop automatically at the end of the anti-creasing phase.

The END, CLEAN FILTERS and FULL TANK lights remain lit and the buzzer sounds for 2 minutes.

The light of the START/PAUSE button goes off and a flashing zero appears on the display.

10. Turn the programme selector dial to “**RESET/OFF**”; all the lights go out. The appliance is switched off.

Remove the laundry.

If you open and then close the door before turning the programme selector dial to “RESET/OFF”, all the lights corresponding to the phases making up the performed programme come on and the display shows the duration of the programme.

After each use

- Clean the filters (see page 11).
- Empty the water reservoir (see page 12).

Important!

If the drying programme has to be stopped before it reaches the end, we recommend that you turn the programme selector dial to position “Cooling” and wait until the end of this phase before removing the laundry. This will avoid a build-up of heat inside the appliance. To do this first turn the dial to “**RESET/OFF**” and then to “Cooling” and depress START/PAUSE Button.





Modifying the programme

To change a programme which is running, first cancel it by turning the programme selector dial to “**RESET/OFF**”. Select the new programme and press the START/PAUSE Button.

Hints & Tips on Drying

Before placing articles of laundry in your tumble dryer, check the care labels to ensure they are recommended for tumble drying.

Care Labels you may find on your laundry

-  may be tumble dried
-  normal drying (high temperature)
-  delicate drying (low temperature)
-  do not tumble dry

 **Do not overload the appliance.**

Here is a list of the approximate weight of some common laundry items.

Sheet	700 to 1000 g
Pillowcase	100 to 200 g
Tablecloth	400 to 500 g
Table Napkin	50 to 100 g
Kitchen Towel	70 to 120 g
Linen Hand Towel	100 to 150 g
Hand Towel	150 to 250 g
Bath Towel	700 to 1000 g
Bathrobe	1000 to 1500 g
Shirt	200 to 300 g
Apron	150 to 200 g

- Always load well spun laundry. The higher the spin speed the lower the electricity consumption and the shorter the drying time.
- DO NOT load dripping wet laundry into the dryer. Roll the article in a towel or spin to remove excess water.
- Close poppers and zips and fasten any buttons.
- Sort the laundry. Separate synthetics from cotton/linens, and dry separately.
- Remove the laundry immediately after the programme has finished.
- Use a fabric conditioning sheet to reduce static. We recommend the sheet is pinned to an article of laundry (using a safety pin).
- Mix the load i.e. large and small articles.
- When drying large items such as sheets, we recommend you periodically stop the dryer to redistribute the load.

DO NOT use the tumble dryer to dry the following:

- Articles contaminated with inflammable substances e.g. petrol, cleaning solvents, cooking oil, fats or hair lacquer.
- Woollen and synthetic/wool mixtures unless the item is labelled as suitable for tumble drying.
- Very delicate articles such as silk.
- Very large and bulky items such as duvets or sleeping bags.

Maintenance and Cleaning

You must **disconnect** the appliance from the electricity supply, before you can carry out any cleaning or maintenance work.

External cleaning

Use only soap and water and then dry thoroughly.

Important: do not use methylated spirit, diluents or similar products.

Cleaning the door

Clean periodically the interior part of the door to remove any fluff from the seals around the filter. Regular cleaning ensures correct drying.

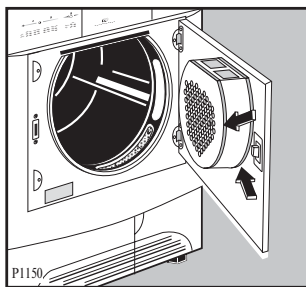

Cleaning the filters

Your dryer will only function well if the filters are clean.

The filters collect all the fluff which accumulates during drying and they must therefore be cleaned at the end of each programme, before removing the laundry, with a damp cloth. The CLOGGED FILTERS light reminds you to carry out this operation.

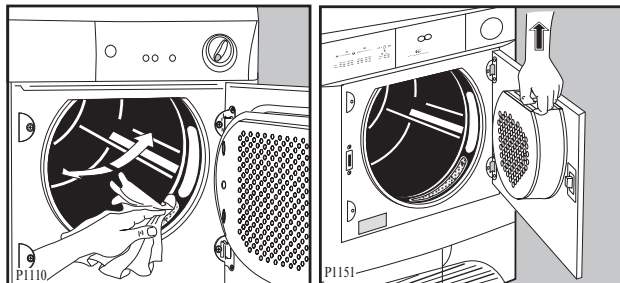

The filter in the inner door must be removed for cleaning.

Do not be alarmed by the amount of fluff. It is not due to excessive wear caused by the dryer. All fabric loses fluff when drying but it goes un-noticed in the air. In a tumble dryer it simply collects in the filter.

After a while, a whitish patina due to detergent residue on laundry forms on the filters. When this occurs, clean the filters with warm water using a brush. Remove the filter in the door opening as per picture (it can be positioned with the tooth facing to the left or to the right).

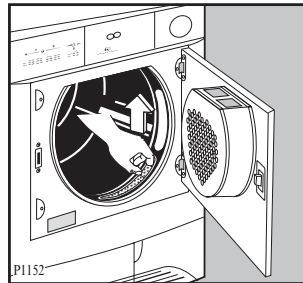

 **Do not use the appliance without filters.**

Cleaning the condenser unit

Clean the air condenser when CLOGGED CONDENSER light comes on.

The condenser is situated at the lower part of the cabinet behind a small door. To open the door, push the catch as per picture.

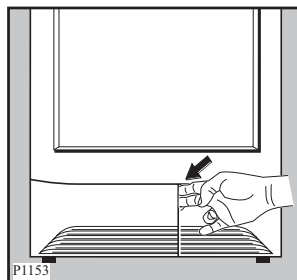

During the drying cycle or at the end, it is normal for water to be present on the surface of the condenser insertion .

To pull out the condenser, first turn the two red stops downwards as shown below and then remove the condenser unit holding it at the handle.

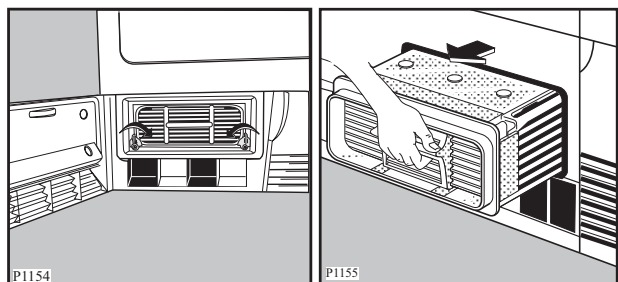

Clean it with a brush and rinse it under the shower if necessary.

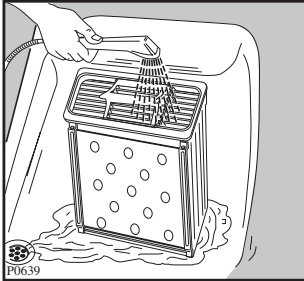

Also clean the outside, removing all fluff.

Clean the rubber seal round the condenser cabinet and in the inner part of the small door with a damp cloth.

Important! Do not use pointed objects or utensils to clean the spaces between the plates, as this could damage the condenser and make it permeable.

Re-fit the condenser, turn the red stops upwards and close the door.

 **Do not use this appliance if the condenser has not been fitted.**

Emptying the water reservoir

Water extracted from the laundry condenses inside the machine and is collected in a reservoir. The reservoir must be emptied after each drying cycle to ensure efficient operation when the machine is next used. The FULL TANK light reminds you of this operation.

Proceed as follows:

- Pull out the reservoir
- Turn it upside down and let water flow down
- Re-fit the reservoir

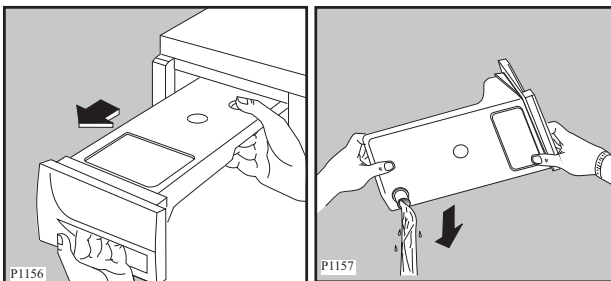

The reservoir must be re-inserted correctly.

If this is not done the pilot light FULL TANK comes on during next drying and the programme stops, leaving the laundry damp. The buzzer will sound.

After inserting the reservoir the START/PAUSE button has to be depressed again to allow the programme to continue.

Handy tip: The condensed water may be used in a steam iron or to top up a battery, etc. In this case it must be filtered (e.g. through a coffee filter).

Cleaning the drum

When your laundry does not reach the desired degree of dryness, in other words, when it turns out either too dry or too damp, we advise you to clean the inside of the drum with a cloth soaked with vinegar.

This will eliminate the slight patina that has formed in the drum (due to residues of detergent and softeners used in the washing, and to the lime contained in the water), which prevents the probes from detecting the correct degree of dryness.

Cleaning the air intake grille

Using a vacuum cleaner remove the fluff from the air intake grille at the back of the appliance.

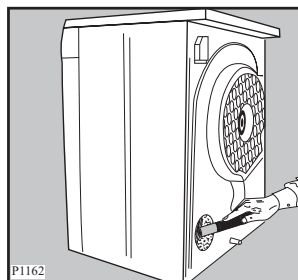

Something Not Working

Certain problems are due to lack of simple maintenance or oversights, which can be solved easily without calling out an engineer. Before contacting your local Service Centre, please carry out the checks listed below.

IMPORTANT: if the END light flashes, the buzzer sounds and an alarm code is displayed, switch the machine off and call your local Service Force Centre..

Symptom	Possible causes
The tumble dryer does not start	<ul style="list-style-type: none"> ● The door(s) has (have) not been closed. ● The plug is not properly inserted in the power socket. ● There is no current at the socket. ● The main fuse or the fuse in the plug has blown. ● The selector dial is not set correctly. ● The water reservoir is full or not properly inserted (the FULL TANK light is on). The programme starts in any case but it stops after approx. 4 minutes. ● The START/PAUSE Button has not been depressed. ● The DELAY START option has not been selected.
Drying takes too long or laundry is not dry enough.	<ul style="list-style-type: none"> ● The laundry has not been spun properly. ● The filters and/or the condenser are clogged up. ● The water reservoir is full. ● The room temperature is too high. ● The selected time or drying cycle was not suitable for the laundry. ● The LOW TEMPERATURE button has been pressed. ● There is too much laundry inside the appliance. ● The dryer is not correctly installed.
The drum light does not light up:	<ul style="list-style-type: none"> ● The Programme/Time selector dial is on position "RESET/OFF". ● The lamp is defective.

If after the above checks, there is still a fault, call your local Service Force Centre.

Service & Spare Parts **SERVICE FORCE**

In the event of your appliance requiring service, or if you wish to purchase spare parts, please contact your local Service Force Centre by telephoning:

0870 5 929929

Your telephone call will be automatically routed to the Service Force Centre covering your post code area.

For the address of your local Service Force Centre and further information about Service Force, please visit the website at www.serviceforce.co.uk.

Before calling out an engineer, please ensure you have read the details under the heading "Something Not Working".

When you contact the Service Force Centre you will need to give the following details:

1. Your name, address and post code
2. Your telephone number
3. Clear and concise details of fault
4. The model and serial number of the appliance (found on the rating plate - see picture)
5. The purchase date.

Please note that a valid purchase receipt or guarantee documentation is required for in-

guarantee service calls.

To buy accessories, consumables and spare parts at our online shop please visit: <http://www.zanussi-electrolux.co.uk>

Customer Care Department

For general enquiries concerning your Zanussi Electrolux appliance or for further information on Zanussi Electrolux products, please contact our Customer Care Department by letter or telephone at the address below or visit our website at www.zanussi.co.uk

Customer Care Department

Major Appliances

Addington Way

Luton

Bedfordshire

LU4 9QQ

Tel 08705 727727*

* calls to this number may be recorded for training purposes.

Guarantee Conditions

Standard guarantee conditions

We, Zanussi Electrolux, undertake that if, within 12 months of the date of the purchase, this ZANUSSI ELECTROLUX appliance or any part thereof is proved to be defective by reason only of faulty workmanship or materials, we will, at our option repair or replace the same **FREE OF ANY CHARGE** for labour, materials or carriage on condition that:

- The appliance has been correctly installed and used only on the electricity supply stated on the rating plate.
- The appliance has been used for normal domestic purposes only, and in accordance with the manufacturer's instructions.
- The appliance has not been serviced, maintained, repaired, taken apart or tampered with, by any person not authorised by us.
- All service work under this guarantee must be undertaken by a Service Force Centre.
- Any appliance or defective part replaced shall become the Company's property.
- This guarantee is in addition to your statutory and other legal rights.

Home visits are made between **8.30am** and **5.30pm** Monday to Friday. Visits may be available outside these hours in which case a **premium** will be charged.

Exclusions

This guarantee does not cover:

- Damage or calls resulting from transportation, improper use or neglect, the replacement of any light bulbs or removable parts of glass or plastic.
- Costs incurred for calls to put right an appliance which is improperly installed or calls to appliances outside the United Kingdom.
- Appliances found to be in use within a commercial environment, plus those which are subject to rental agreements.
- Products of Zanussi Electrolux manufacture which are NOT marketed by Zanussi Electrolux.

European guarantee



If you should move to another country within Europe then your guarantee moves with you to your new home subject to the following qualifications:

- The guarantee starts from the date you first purchased your product.
- The guarantee is for the same period and to the same extent for labour and parts as exists in the new country of use for this brand or range of products.
- The guarantee relates to you and cannot be transferred to another user.
- Your new home is within the European Community (EC) or European Free Trade Area.
- The product is installed and used in accordance with our instructions and is only used domestically, i.e. a normal household.
- The product is installed taking into account regulations in your new country.

Before you move please contact your nearest Customer Care Centre, listed below, to give them details of your new home. They will then ensure that the local Service Organisation is aware of your move and able to look after you and your appliances.

France	Senlis	+33 (0) 344 62 29 29
Germany	Nurnberg	+49 (0) 800 234 7378
Italy	Pordenone	+39 0434 39 4700
Sweden	Stockholm	+46 (0) 8 672 53 90
UK	Luton	+44 (0)8705 727727

Installation Instructions

-  It is dangerous to alter the specifications or attempt to modify this product in any way.
-  Care must be taken to ensure that the appliance does not stand on the electrical supply cable.
-  Any electrical work required to install this appliance should be carried out by a qualified electrician or competent person.

Technical Specifications

DIMENSIONS	Height Width Depth	85 cm (33.5") 60 cm (23.6") 58 cm (22.8")
POWER SUPPLY VOLTAGE TOTAL POWER ADSORBED		240 V/50 Hz 2450 W (13A)
MAX LOAD CAPACITY	Cotton, linen Synthetics	7 kg (13.2 lbs) 3,5 kg (6.6 lbs)
DRUM VOLUME		108 l
CONSUMPTIONS	Cotton, linen Cotton, linen Synthetics	3.95 kWh (7 kg store dry) 3.05 kWh (7 kg iron dry) 1.45 kWh (3,5 kg store dry)

-  This appliance complies with the following E.E.C. Directives:
- 73/23 EEC of 19.2.73 (Low Voltage Directive) and subsequent modifications;
 - 89/336 EEC of 3.5.89 (Electromagnetic Compatibility Directive) and subsequent modifications.

Adjusting the level of conductivity

Water contains, a variable quantity of limestone and mineral salts of which quantities vary according to geographical locations thus varying its conductivity values.

Relevant variations of the conductivity of the water compared to those prefixed by the factory could slightly influence the residual humidity of the laundry at the end of the cycle.

Your dryer allows you to regulate the sensitivity of the drying sensor based on conductivity values of the water by using the following procedure.

Procedure:

Turn the programme selector dial to switch on the appliance

In selection mode press simultaneously the buttons 3 and 6 until «CO» appears on the digits.

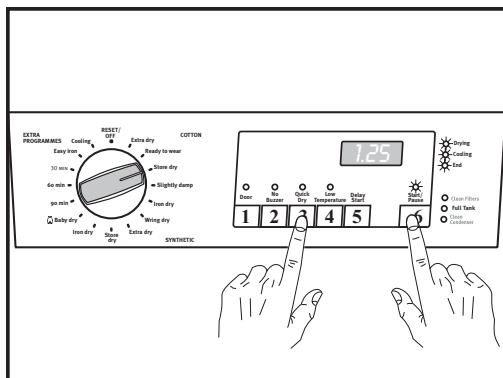

Adjusting the level of conductivity:

Press the button 5 sequentially: the level of conductivity is indicated by the lighting of the horizontal hyphens.

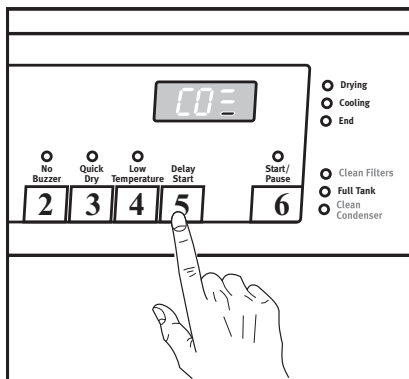

Display	Conductivity degree	Approximative value (µS/cm)
CO _	Low	< 300
CO =	Medium	300 - 600
CO ≡	High	> 600

Normally, the appliance is factory-set to the highest level; however, certain models may be configured differently.

Memorizing the new setting:

Simultaneously press down the buttons 3 and 6 until the previous drying cycle time appears again on the display and the buzzer sounds.

Unpacking

Warning !

-  Slide out the polythene bag containing the polystyrene block before using the appliance. Pull off adhesive strips from inside machine on top of drum

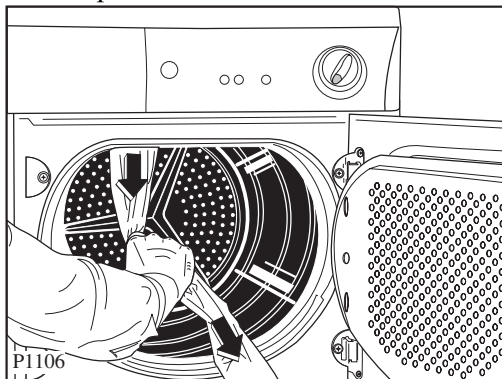

-
-  **Should the appliance be moved, it must be transported vertically.**
-

Positioning

It is recommended that, for your convenience, the machine is positioned close to your washing machine.

The tumble dryer must be installed in a clean place, where dirt does not build up.

Air must be able to circulate freely all round the appliance. Do not obstruct the front ventilation grille or the air intake grilles at the back of the machine.

To keep vibration and noise to a minimum when the dryer is in use, it should be placed on a firm, level surface.

Once in its permanent operating position, check that the dryer is absolutely level with the aid of a spirit level. If it is not, raise or lower the feet until it is.

The feet must never be removed.

Do not restrict the floor clearance through deep-pile carpets, strips of wood or similar. This might cause heat build-up which would interfere with the operation of the appliance.

Important

The hot air emitted by the tumble dryer can reach temperatures of up to 60°C. The appliance must therefore not be installed on floors which are not resistant to high temperatures.

When operating the tumble dryer, the room temperature must not be lower than +5°C and higher than +35°C, as it may affect the performance of the appliance.

Stacking kit (optional accessory)

It should be possible to stack your new dryer on top of a front loading washing machine with cover's depth between 48 and 60 cm.

Read carefully the instructions supplied with the kit.

Please contact your local Service Force Centre for further advice.

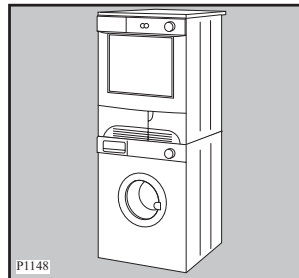

Door reversal

To make it easier to load or unload the laundry the door can be reversed.

This operation must be carried out by qualified personnel.

Please contact the nearest Zanussi Service Force Centre.

This will be a chargeable option.

Electrical connection Any electrical work required to install this appliance should be carried out by a qualified electrician or competent person.

-  **WARNING: THIS APPLIANCE MUST BE EARTHED.**

The manufacturer declines any liability should this safety measure not be observed. Should the appliance power supply cable need to be replaced, this must be carried out by our Service Centre.

The power supply cable must be accessible after installing the machine.

Before switching on, make sure the electricity supply voltage is the same as that indicated on the appliance's rating plate. (See picture on page 4).

The appliance is supplied with a 13amp plug fitted. In the event of having to change the fuse in the plug supplied, a 13amp ASTA approved BS 1363/A fuse must be used.

Should the plug need to be replaced for any reason, proceed as described below. The wires in the mains lead are coloured in accordance with the following code:

Green and Yellow - Earth
Blue - Neutral
Brown - Live

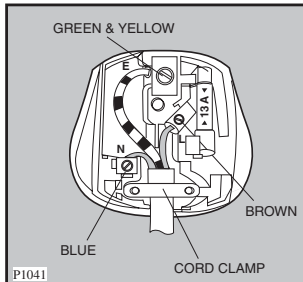

The wire coloured green and yellow must be connected to the terminal marked with the letter «E» or by the earth symbol \equiv or coloured green and yellow.

The wire coloured blue must be connected to the terminal «N» or coloured black.

The wire coloured brown must be connected to the terminal marked «L» or coloured red.

Upon completion there must be no cut, or stray strands of wire present and the cord clamp must be secure over the outer sheath.

WARNING:



A cut off plug inserted into a 13 amp socket is a serious safety (shock) hazard.

Ensure that the cut off plug is disposed of safely.

Permanent connection

In the case of permanent connection it is necessary that you install a double pole switch between the appliance and the electricity supply (mains), with a minimum gap of 3mm between the switch contacts and of a type suitable for the required load in compliance with the current electrical regulations.

The switch must not break the yellow and green earth cable at any point.

 **From the Electrolux Group. The world's No. 1 choice.**

The Electrolux Group is the world's largest producer of powered appliances for kitchen, cleaning and outdoor use. More than 55 million Electrolux Group products (such as refrigerators, cookers, washing machines, vacuum cleaners, chain saws and lawn mowers) are sold each year to a value of approx. USD 14 billion in more than 150 countries around the world.

© Electrolux plc 2006

Free Manuals Download Website

<http://myh66.com>

<http://usermanuals.us>

<http://www.somanuals.com>

<http://www.4manuals.cc>

<http://www.manual-lib.com>

<http://www.404manual.com>

<http://www.luxmanual.com>

<http://aubethermostatmanual.com>

Golf course search by state

<http://golfingnear.com>

Email search by domain

<http://emailbydomain.com>

Auto manuals search

<http://auto.somanuals.com>

TV manuals search

<http://tv.somanuals.com>