

ZANUSSI

Electrolux

User
Manual

Tumble
Dryer



ZDC 67550W



electrolux **3**

Welcome to the world of Electrolux

Thank you for choosing a first class product from Electrolux, which hopefully will provide you with lots of pleasure in the future. The Electrolux ambition is to offer a wide variety of quality products that make your life more comfortable. You find some examples on the cover in this manual. Please take a few minutes to study this manual so that you can take advantage of the benefits of your new machine. We promise that it will provide a superior User Experience delivering Ease-of-Mind. Good luck!

GB

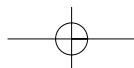
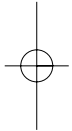
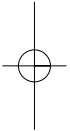



4 electrolux **contents** electrolux

Contents

Safety information.....	5
Product description	7
Control panel.....	7
Use.....	8
Drying hints	12-13
Drying programmes.....	14-15
Programme information	16
Care and cleaning	17
Something not working	20-22
Technical data	23
Consumption values	24
Installation	25-26
Environment concerns	27
Guarantee conditions	28
Customer service centres	29

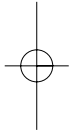
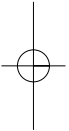

The following symbols are used in this manual:



Important information concerning your personal safety and information on how to avoid damaging the appliance.



General information and tips



Environmental information

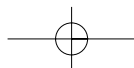

Safety Information



In the interest of your safety and to ensure the correct use, before installing and first using the appliance, read this user manual carefully, including its hints and warnings. To avoid unnecessary mistakes and accidents, it is important to ensure that all people using the appliance are thoroughly familiar with its operation and safety features. Save these instructions and make sure that they remain with the appliance if it is moved or sold, so that everyone using it through its life will be properly informed on appliance use and safety.

General safety

- It is dangerous to alter the specifications or attempt to modify this product in any way.
- This appliance is not intended for use by persons (including children) with reduced physical, sensory or lack of experience and knowledge, unless they have been given supervision or instruction concerning use of the appliance by a person responsible for their safety.
- Make sure that small pets do not climb into the drum. To avoid this, please check into the drum before using.
- Any objects such as coins, safety pins, nails, screws, stones or any other hard, sharp material can cause extensive damage and must not be placed into the machine.
- In order to avoid danger of fires caused by excessive drying, do not use appliance to dry the following items: Cushions, quilts and the like (these items accumulate heat).
- Items such as foam rubber (latex foam), shower caps, waterproof textiles, rubber backed articles and clothes or pillows fitted with foam rubber pads should not be dried in the tumble dryer.
- Always unplug the appliance after use, clean and maintenance.
- Under no circumstances should you attempt to repair the machine yourself. Repairs carried out by inexperienced persons may cause injury or serious malfunctioning. Contact your local Service Centre. Always insist on genuine spare parts.
- Items that have been soiled with substances such as cooking oil acetone, petrol, kerosene, spot removers, turpentine, waxes and wax removers should be washed in hot water with an extra amount of detergent before being dried in the tumble dryer.
- **Danger of explosion:** Never tumble dry items that have been in contact with inflammable solvents (petrol, methylated spirits, dry cleaning fluid and the like). As these substance are volatile, they could cause an explosion. Only tumble dry items washed with water.
- **Risk of fire:** items that have been spotted or soaked with vegetable or cooking oil constitute a fire hazard and should not be placed in the tumble dryer.
- **Warning:** Never stop a tumble dry before the end of the drying cycle unless all items are quickly removed and spread out so that the heat is dissipated.
- If you have washed your laundry with stain remover you must execute an extra rinse cycle before loading your tumble dryer.
- Please make sure that no gas lighters or matches have accidentally been left in pockets of garments to be loaded into appliance

GB

6 electrolux **safety information**

Installation

- This appliance is heavy. Care should be taken when moving it.
- When unpacking the appliance, check that it is not damaged. If in doubt, do not use it and contact the Service Centre.
- All transit packaging must be removed before use. Serious damage can occur to the product and to property if this is not adhered to. See relevant section in the user manual.
- The final part of a tumble dryer cycle occurs without heat (cool down cycle) to ensure that the items are left at a temperature that ensures that items will not be damaged.
- Any electrical work required to install this appliance should be carried out by a qualified electrician or competent person.
- Care must be taken to ensure that the appliance does not stand on the electrical supply cable.
- If the machine is situated on a carpeted floor, please adjust the feet in order to allow air to circulate freely under the appliance
- After having installed the appliance, check that it is not pressing or standing on its electrical supply cable.
- If the tumble dryer is placed on top of a washing machine, it is compulsory to use the stacking kit (optional accessory).

Use

- This appliance is designed for domestic use. It must not be used for purposes other than those for which it was designed.
- Only wash fabrics which are designed to be machine dried. Follow the instructions on each garment label.
- Do not dry unwashed items in the

tumble dryer.

- Fabric softeners, or similar products, should be used as specified by the fabric softener instructions.
- Do not overload the appliance. See the relevant section in the user manual.
- Clothes which are dripping wet should not be placed in the dryer.
- Garments which have been in contact with volatile petroleum products should not be machine dried. If volatile cleaning fluids are used, care should be taken to ensure that the fluid is removed from the garment before placing in the machine.
- Never pull the power supply cable to remove the plug from the socket; always take hold of the plug itself.
- Never use the tumble dryer if the power supply cable, the control panel, the working surface or the base are damaged so that the inside of the tumble dryer is accessible.

Child safety

- This machine is not intended for use by young children or infirm persons without supervision.
- Children should be supervised to ensure that they do not play with the appliance.
- The packaging components (e.g. plastic film, polystyrene) can be dangerous to children - danger of suffocation! Keep them out of children's reach
- Keep all detergents in a safe place out of children's reach.
- Make sure that children or pets do not climb into the drum.



product description/Control panel electrolux 7

Product description

- 1** Control panel
- 2** Fluff filters
- 3** Rating Plate
- 4** Condenser unit
- 5** Water reservoir
- 6** Adjustable feet

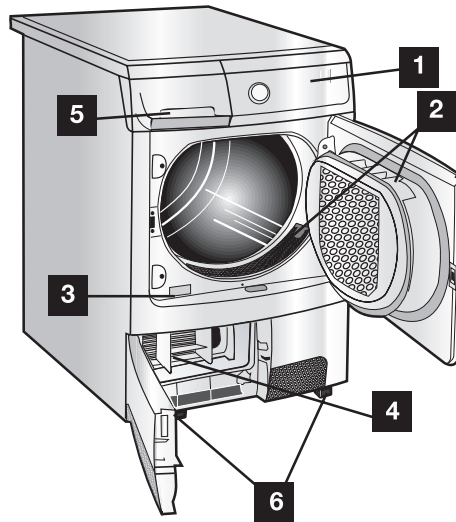

GB

Control panel

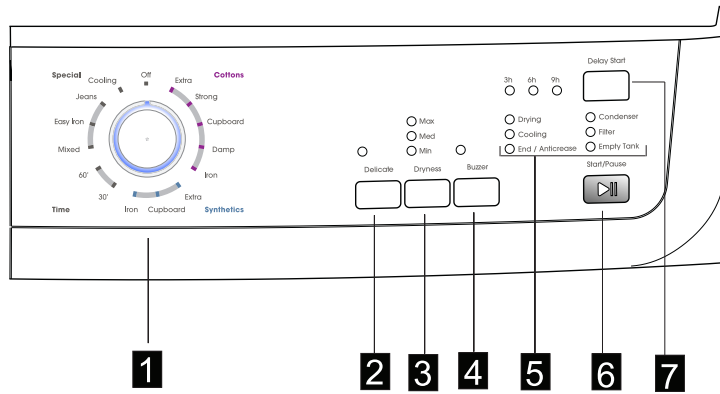

- 1** Programme selector dial
- 2** Delicate button
- 3** Dryness button
- 4** Buzzer button
- 5** Indicator lights
- 6** Start/Pause button
- 7** Delay Start button

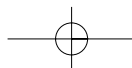

8 electrolux use**Use****First Use**

- 1 Ensure that the electrical connections comply with the installation instructions.
- 1 Remove the polystyrene block and any material from the drum.
- 1 Before using your tumble dryer for the first time, we recommend that you to place a few damp cloths inside the appliance and dry for 30 minutes.
There may be dust inside a brand new tumble dryer.

**Select the required programme**

Turn the programme selector dial to the required programme.

The light Start/Pause starts to flash.

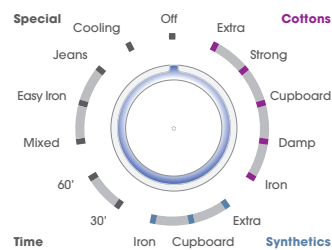
**Daily Use****Load the laundry**

- Connect the appliance.
- Open the door (see picture).



Place the laundry in the drum, one item at a time, shaking them out as much as possible. Close the door.

Please check the laundry does not get caught between the door and filter.

The selector dial is divided into following sections:

- Cottons
- Synthetics
- Time
- Special

Electronically controlled drying (automatic)

Allows you to select electronically controlled or time controlled drying.

The appliance runs these programmes with the help of probes which detect the degree of dampness of the laundry. Simply select the programme according to the type of laundry and degree of drying required.

The selector dial can be turned either clockwise or anticlockwise. The lights Drying,

Cooling and End/Anticrease come on.

At the end of the programme the selector dial must be turned to position Off, to switch the machine off.

Attention!

If you turn the programme selector dial to another programme when the machine is working, the lights of the programme progress display start to flash. The machine will not perform the new selected programme.

Programme Option buttons

Depending on the programme, different functions can be combined. These must be selected after choosing the desired programme and before depressing the Start/Pause button.

When these buttons are pressed, the corresponding pilot lights come on. When they are pressed again, the pilot lights go out.

Select Delicate

Pressing this button allows drying to be performed at a lower temperature, for delicate items.



The corresponding pilot light comes on. This option can also be used for time controlled drying. DELICATE is only suitable for use with loads of up to 3kg!

When the programme has finished the pilot lights End is on.

Select the Dryness

Press the Dryness button repeatedly, to select the desired option. The relevant light will illuminate. Laundry becomes dryer from MIN to MAX.

Press the Dryness button as many times as necessary until the small light at the level of residual dampness required is illuminated.



When the programme has finished the pilot lights End is on.

Select the Buzzer

When the drying cycle has finished, an intermittent audible signal will sound.

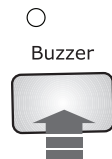

By depressing button Buzzer the acoustic signal is switched off in the following cases:

- when selecting the programme
- when depressing the buttons
- when the programme selector dial is turned to another position during the programme or when you depress an option button during the cycle
- at the end of the programme.

The corresponding light comes on

Select the Start/Pause

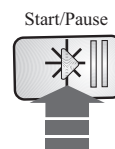

10 electrolux use

Press this button to start the dryer after having selected the programme and the options.

The relevant light will stop flashing.

If the programme selector dial is turned to another position, when the machine is running, the buzzer will sound and the programme phase indicator lights will flash.

The drum turns alternately in both directions during drying.

All drying programmes end with a 10 minute cooling phase (light Cooling is on).

You may remove the laundry after this phase.

The lights End/Antcrease, Filter and Empty Tank illuminate and the buzzer sounds

If the door of the appliance or the small door at the bottom is opened while the programme is running, this button must be pressed again after closing the door in order to restart the programme from the point at which it was interrupted. This button must be depressed also after a power failure and after having re-inserted the water reservoir, if it has been emptied in the middle of a programme after the Empty Tank light illuminates.

In both cases the light of the Start/Pause button flashes to remind you that the start button needs to be pressed again.

Select the Delay Start

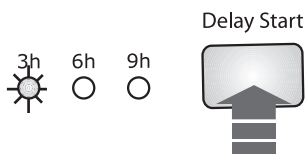

This button allows you to delay the starting of the programme by 3, 6 or 9 hours.

Press the button until the light relevant to the desired delay illuminates. This option must be selected **after** having

selected the programme and **before** pressing START/PAUSE to start the programme.

The machine begins the countdown, which is shown by the pilot lights. For example, if you have chosen a 9-hour delay (pilot light 9h lit), after 3 hours, 9h goes out and 6h lights up; after 3 more hours, 6h goes out and 3h lights up.

When the 9 hours are over (pilot light 3h off), the drying cycle begins. During the delayed start period, it is not possible to change the programme or the selected delay. If you wish to do so, you must first cancel everything by rotating the programme selector dial to position "Off".

Select the new programme, the options and the delayed start, then press START/PAUSE. If you wish to change only the options, this can be done on the condition that the new option(s) is(are) compatible with the programme. Set the machine to PAUSE by depressing the relevant button, select the new option(s) and depress START/PAUSE button again.

If you wish to add some laundry while the machine is performing the countdown, after having done so and having closed the door, press START/PAUSE again, in order to allow the machine to complete the remaining countdown time.

Indicator lights

These lights indicate the following functions:

"Drying" light

This light indicates that the appliance is in the drying phase.

"Cooling" light

This light indicates that the appliance is in the cooling phase. At the end of drying, there is a 10 minute cooling phase to cool the

laundry.

“Empty Tank” light

This light comes on at the end of the programme to remind you that the water reservoir must be emptied out. If this light illuminates during a programme this means that the water reservoir is full. The buzzer sounds, the programme stops, the light of the Start/Pause button flashes. This light comes on also when the water reservoir is not inserted correctly.

“Filter” light

This light illuminates at the end of the programme to remind you that the filters must be cleaned.

“Condenser” light

It comes on every 80 cycles to remind you that the condenser must be cleaned.

Cancelling a programme

Turn the selector dial to “Off” to cancel a programme which is running. You can now select a new programme.

At the end of the programme

If the laundry is not removed at the end of the cycle, the dryer performs an **anti-creasing** phase (duration: 30 minutes maximum).

If you do not remove the laundry, the dryer will stop automatically at the end of the anti-creasing phase.

Lights End/Anticrease, Filter and Condenser remain lit and the buzzer sounds for 2 minutes.

Turn the programme selector dial to “Off” to switch the machine off. Remove the laundry from the drum and carefully check that the drum is empty.

If you open and then close the door before turning the selector dial to “Off” all the lights corresponding to the phases making up the performed programme come on.

After each use

- Clean the filters.
- Empty the water reservoir.

Important!

If the drying programme has to be stopped before it reaches the end, we recommend that you turn the programme selector dial to position Cooling and wait until the end of this cooling phase before removing the laundry. This will avoid a build-up of heat inside the appliance. To do this first turn the dial to “Off” and then to Cooling and depress Start button.

Modifying the programme

To change a programme which is running, first cancel it by turning the programme selector dial to “Off”. Select the new programme and press the Start button .

GB

12 electrolux **drying hints**

Drying hints

**Before loading the laundry**

Never tumble dry the following:
Particularly delicate items such as net curtains, woollen, silk, fabrics with metal trim, nylon tights, bulky materials such as anoraks, blankets, eiderdowns, sleeping bags, feather quilts and any items containing rubber foam or materials similar to rubber foam.

- Always follow the instructions on garment labels:



may be tumble dried



normal drying (high temperature)



delicate drying (low temperature)



do not tumble dry

- Close pillowcases and covers with fasteners to prevent small laundry items getting tangled inside them. Close press studs, zips and hooks and tie belts and apron strings.
- Sort laundry according to type and degree of drying required.
- Do not over-dry laundry, this avoids creasing and saves energy.
- Avoid drying dark clothes with light coloured fluffy items such as towels as they could attract the fluff.
- The laundry must be thoroughly spun before tumble drying.
- **Easy-care items**, too, e.g. shirts, should be briefly pre-spun before

drying (depending on crease resistance approx. 30 seconds or using the special brief spin programme of your washing machine).

- Knitted textiles (knitted underwear) may shrink a little during drying. Please do not overdry items of this type. It is advisable to allow for shrinkage when choosing the size of new purchases.
- You can also put starched items into your dryer. However, to achieve the desired starched effect, choose the programme "iron dry". To remove any starch residues, wipe out the internal drum after drying with a moist cloth and then rub it dry.
- To avoid a static charge when drying is completed, use either a fabric softener when you are washing the laundry or a fabric conditioner specifically for tumble dryers.
- Remove the laundry when the dryer has finished drying.
- If individual items are still damp after drying, set a brief post-drying time, but **at least 30 minutes**. This will be necessary particularly for multilayered items (e.g. collars, pockets, etc.).

Make sure that no metal objects are left in the laundry (e.g. hair clips, safety pins, pins).

Button up pillowcases, close zip fasteners, hooks and poppers. Tie any belts or long tapes.

To avoid laundry becoming tangled: close zips, button up duvet covers and tie loose ties or ribbons (e.g. of aprons).

Turn items with double-layered fabrics inside out (e.g. with cottonlined anoraks, the cotton layer should be outermost). These fabrics will then dry better.

Maximum loads

Recommended loads are indicated in the programme charts.

General rules:

Cotton, linen: drum full but not too tightly packed;

Synthetics: drum no more than half full;

Delicate fabrics and woollens: drum no more than one third full.

Try to load to the maximum capacity of the machine as small loads are uneconomical.

Laundry weights

The following weights are indicative:

bathrobe	1200 g
napkin	100 g
quilt cover	700 g
sheet	500 g
pillow case	200 g
tablecloth	250 g
towelling towel	200 g
tea cloth	100 g
night dress	200 g
ladies' briefs	100 g
men's work shirt	600 g
men's shirt	200 g
men's pyjamas	500 g
blouse	100 g
men's underpants	100 g

14 electrolux **drying programmes**

Drying programmes

Programme	Type of laundry	Options	Description of programme
Extra	Cotton and linen	Dryness Delicate Buzzer Delay Start	Drying thick or multi-layered textiles, e.g. terry towelling items Max load: 7 kg
Strong	Cotton and linen	Dryness Delicate Buzzer Delay Start	Drying thick textiles, e.g. terry towelling items, towels.
Cupboard	Cotton and linen	Dryness Delicate Buzzer Delay Start	Drying textiles of even thicknesses, e.g. terry towelling items, knitted items, towels.
Damp	Cotton and linen	Dryness Delicate Buzzer Delay Start	For thin textiles which are still to be ironed, e.g. knitted items, cotton shirts.
Iron	Cotton and linen	Dryness Delicate Buzzer Delay Start	For cotton or linen laundry which are still to be put through a machine, e.g. bedding, table linen.
Extra	Synthetics	Dryness Delicate Buzzer Delay Start	Drying thick or multi-layered textiles, e.g. pullovers, bedding, table linen.
Cupboard	Synthetics	Dryness Delicate Buzzer Delay Start	For thin textiles which are not ironed, e.g. easy care shirts, table linen, baby's clothes, socks, underwear.
Iron	Synthetics	Dryness Delicate Buzzer Delay Start	For thin textiles which are still to be ironed, e.g. knitted items, cotton shirts.
Time 30 min 60 min	Synthetics Cotton	Delicate Buzzer Delay Start	Drying thick or multi-layered textiles, e.g. terry towelling items. For drying individual items of laundry or for small volumes of less than 1kg.

Drying programmes

Programme	Type of laundry	Options	Description of programme
Special Mixed	Cotton Cupboard dry Synthetics	Dryness Delicate Buzzer Delay Start	Special programme for cotton and easy care, which can drying together in the same time.
Special Easy iron	Synthetics	Delicate Buzzer Delay Start	Special programme with anti-crease mechanism for easy care textiles such shirts and blouses; for minimum ironing effort. The result depends on the type and quality of textiles. (The loading volume corresponds to approx. 4 to 5 shirts.) Recommendation: Place textiles in the dryer straight after spinning. Once dried, immediately remove textiles and place on clothes hanger.
Special Jeans	Cotton Cupboard dry	Dryness Delicate Buzzer Delay Start	Special programme for leisure clothing, such as jeans, sweat-shirts, etc., of different material thicknesses (e.g. at the cuffs and seams).
Special Cooling	Cotton and linen Synthetics	Buzzer	Special programme, lasting around 10 minutes, for refreshing or gently cleaning textiles with commercially available dry cleaning sets. (Only use those products which are declared as suitable for the drier by the manufacturer; please observe the manufacturer's instructions for use.)



Max Cottons load:	7 kg
Max Synthetics load:	3 kg
Max Time load:	1 kg
Max Special Mix load:	3 kg
Max Special Jeans load:	7 kg

16 electrolux programme information

Programme information



Objective	Implementation		
Adjusting the level of conductivity	<p>Water contains, a variable quantity of limestone and mineral salts of which quantities vary according to geographical locations thus varying its conductivity values. Relevant variations of the conductivity of the water compared to those prefixed by the factory could slightly influence the residual humidity of the laundry at the end of the cycle. Your dryer allows you to regulate the sensitivity of the drying sensor based on conductivity values of the water by using the following procedure.</p> <p>To access adjustment mode:</p> <ol style="list-style-type: none"> 1. Turn the programme selector dial to switch on the appliance. 2. In selection mode, press simultaneously the buttons DRYNESS and START. <p>Press the buttons down until the pilot lights above each ones begin to flash and one of the pilot lights indicating the drying phase lights Empty Tank, Filter and Condenser remains it.</p> <p>Adjusting the level of conductivity:</p> <p>Press the START/PAUSE button sequentially: the level of conductivity is indicated by the phase pilot lights, which light in various combinations as follows:</p>		
	LED lit	Conductivity	Approximate value $\mu\text{S}/\text{cm}$
	Empty Tank	Low	< 300
	Filter	Medium	300-600
	Condenser	High	>600
Off = Cancelling/ OFF	<p>Normally, the appliance is factory-set to the highest level; however, certain models may be configured differently.</p> <p>Memorizing the new setting:</p> <p>Simultaneously press the buttons DRYNESS and START. Press the buttons down until the pilot lights above each ones stop flashing and the buzzer sounds.</p> <p>To reset a programme and to switch off the machine turn the selector dial to Off. Now can a new programme be selected.</p>		

Care and cleaning



You must **DISCONNECT** the appliance from the electricity supply, before you can carry out any cleaning or maintenance work.

External cleaning

Use only soap and water and then dry thoroughly.

Important: do not use methylated spirit, diluents or similar products..

Cleaning the door

Clean periodically the interior part of the door to remove any fluff from the seals around the filter. Regular cleaning ensures effective drying.



Cleaning the filters

Your dryer will only function well if the filters are clean.

The filters collect all the fluff which accumulates during drying and they must therefore be cleaned **at the end of each programme**, before removing the laundry, with a damp cloth.

The Filter light is on to remind you this operation.

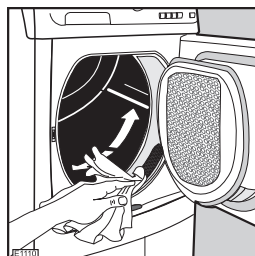

The filter in the inner door must be removed for cleaning.

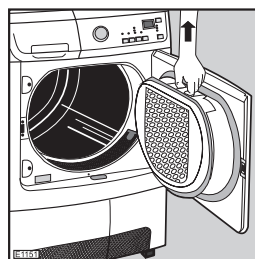

Do not be alarmed by the amount of fluff. It is not due to excessive wear caused by the dryer.

All fabric loses fluff when drying but it goes un-noticed in the air. In a tumble dryer it simply collects in the filter.

After a while, a whitish patina due to detergent residue on laundry forms on the filters. When this occurs, clean the filters with warm water using a brush. Remove the filter in the door opening as per picture (it can be positioned with the tooth facing to the left or to the right).

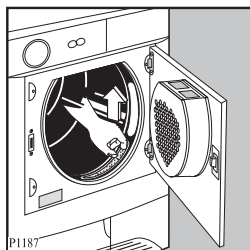

18 electrolux care and cleaning



Do not use the appliance without filters.

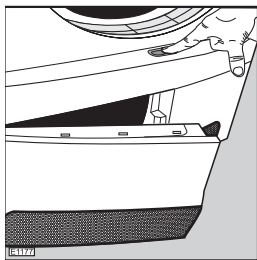

Cleaning the condenser unit

Clean the condenser when the Condenser light comes on. The condenser is situated at the lower part of the cabinet behind a small door. To open the door, push the catch as per picture. During the drying cycle or at the end, it is normal for water to be present on the surface of the condenser insertion.

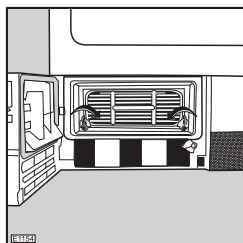

To pull out the condenser, first turn the two red stops downwards and then remove the condenser unit holding it at the handle.

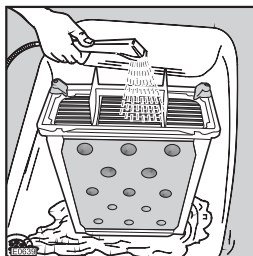
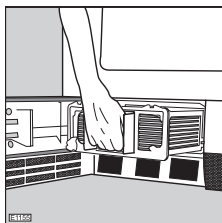

Clean it with a brush and rinse it under the shower if necessary. Also clean the outside, removing all fluff. Clean the rubber seal round the condenser cabinet and in the inner part of the small door with a damp cloth..



Important! Do not use pointed objects or utensils to clean the spaces between the plates, as this could damage the condenser and make it permeable. Re-fit the condenser, turn the red stops upwards and close the door.



Do not use this appliance if the condenser has not been fitted.

Emptying the water reservoir

Water extracted from the laundry condenses inside the machine and is collected in a reservoir. The reservoir must be emptied after each drying cycle to ensure efficient operation when the machine is next used. The pilot light Empty Tank reminds you of this operation.



Proceed as follows:

- Open the small door at the lower part of the cabinet
- Turn the yellow stop upwards
- Pull out the reservoir
- Open the small cover and let the water flow down
- Close the small cover and re-insert the reservoir correctly.
- Push it until it clicks and turn the yellow stop downwards to lock it firmly.
- Close the small door and press the START/PAUSE button again to allow the programme to continue.

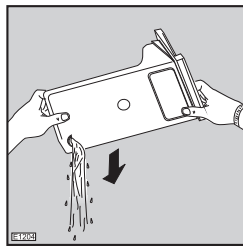
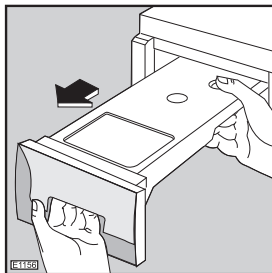

The reservoir must be re-inserted correctly. If this is not done the Empty Tank pilot light Empty Tank comes on during the next drying cycle and the programme stops, leaving the laundry damp.

The buzzer will sound for 1 minute.

After emptying and inserting the reservoir the START-button has to be depressed again to allow the programme to continue.

Handy tip: The condensed water may be used in a steam iron or to top up a battery, etc. In this case it must be filtered (e.g. through a coffee filter).

Cleaning the air intake grille

Using a vacuum cleaner remove the fluff from the air intake grille at the back of the appliance.

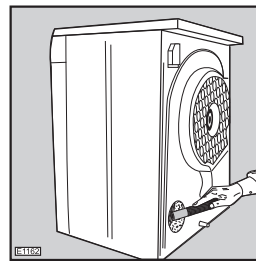

Cleaning the drum

When your laundry does not reach the desired degree of dryness, in other words, when it turns out either too dry or too damp, we advise you to clean the inside of the drum with a cloth soaked with white vinegar.

This will eliminate the slight patina that has formed in the drum (due to residues of detergent and softeners used in the washing, and to the lime contained in the water), which prevents the probes from detecting the correct degree of dryness.

20 electrolux something not working

Something not working

Certain problems are due to lack of simple maintenance or oversights, which can be solved easily without calling out an engineer. Before contacting your local Service Centre, please carry out the checks listed below.

During machine operation it is possible that the red Start/Pause pilot light flashes to indicate that the machine is not working.

Once the problem has been eliminated, press the **Start/Pause** button to restart the programme. If after all checks, the problem persists, contact your local Service Centre.

Malfunction	Possible cause	Solution
Dryer does not work.	<ul style="list-style-type: none"> ● Mains plug is not plugged in or fuse is not working correctly. ● Loading door is open. ● Have you pressed the START/PAUSE button? 	<ul style="list-style-type: none"> ● Plug in at mains socket. Check fuse in fuse box (domestic installation). ● Close loading door. ● Press the START/PAUSE button again.
Drying results unsatisfactory.	<ul style="list-style-type: none"> ● Wrong programme selected. ● Lint filter clogged. ● Heat exchanger clogged with lint. ● Incorrect volume of laundry. ● Ventilation slots in base area covered up. ● Residue on inside surface of drum or drum ribs. ● Conductance of water at installation site differs from 	<ul style="list-style-type: none"> ● Select a different programme the next time you dry (see "Overview of programmes" section). ● Clean lint filter. ● Clean heat exchanger. ● Observe recommended loading volumes. ● Uncover ventilation slots in base area. ● Clean inside surface of drum and drum ribs ● Re-programme standard setting for degree of drying
Loading door does not close.	<ul style="list-style-type: none"> ● Fine strainer not in place and/or large mesh filter not locked in place. 	<ul style="list-style-type: none"> ● Install fine strainer and/or snap large mesh filter into place.

Malfunction	Possible cause	Solution
When pressing a button, the corresponding button flashes several times.	<ul style="list-style-type: none"> ● Washing protection. After the start of the programme, the option can no longer be set. 	<ul style="list-style-type: none"> ● Turn the programme knob to OFF. Set the programme again
Programme inactive, Empty Tank light illuminated.:	<ul style="list-style-type: none"> ● Condensation tank is full. 	<ul style="list-style-type: none"> ● Empty condensation tank, then start programme with START/PAUSE button.
Drying cycle ends shortly after programme starts. END light illuminated.	<ul style="list-style-type: none"> ● Not enough washing loaded or washing loaded is too dry for selected programme. 	<ul style="list-style-type: none"> ● Select time programme or higher drying level (e.g. EXTRA DRY instead of CUPBOARD).
Drying cycle lasts an unusually long time. Note: After around 5 hours the drying cycle ends automatically (see „Drying cycle complete“)	<ul style="list-style-type: none"> ● Lint filter clogged. ● Heat exchanger clogged with lint. ● DELICATE button pressed and load volume too big. ● Load volume too big. ● Laundry insufficiently predrained. 	<ul style="list-style-type: none"> ● Clean lint filter ● Clean heat exchanger. ● DELICATE is only suitable for use with loads of up to 3 kg! ● Reduce load volume. ● Laundry must be adequately pre-drained.

22 electrolux **something not working**

If you are unable to identify or solve the problem, contact your local Service Force Centre. Before telephoning, make a note of the model, serial number and purchase date of your machine: the Service Centre will require this information.



IMPORTANT: if you call out an engineer to a fault listed in the table or to repair a fault caused by incorrect use or installation, a charge will be made even if the appliance is under guarantee.

Technical data

GB

Dimensions	Width	60 cm
	Height	85 cm
	Depth	58 cm
Electrical connection Voltage - Overall power - Fuse	Information on the electrical connection is given on the rating plate on the inner edge of the appliance door	
Depth with loading door open		109 cm
Maximum Load	Cotton	7 kg
	Synthetics	3 kg
Use		Domestic + 5°C + 35°C

- CE** This appliance conforms with the following EU Directives:
- 73/23/EEC dated 19.02.1973 Low Voltage Directive
 - 89/336/EEC dated 03.05.1989 EMC Directive inclusive of Amending Directive 92/31/EEC
 - 93/68/EEC dated 22.07.1993 CE Marking Directive

24 electrolux consumption values

Consumption values			
Programme	Programme duration (in minutes)	Energy consumption (in kWh)	Revolutions per minute
Cottons Cupboard ¹⁾	125	3,92	1000
Cottons Iron ¹⁾	96	3,05	1000
Cottons Cupboard ¹⁾	110	3,39	1400
Cottons Iron ¹⁾	85	2,5	1400
Synthetics Cupboard ²⁾	55	1,45	1200



¹⁾ Max Cottons load: 7 kg
²⁾ Max Synthetics load: 3 kg



The consumption values have been established under standard conditions. They may deviate when the machine is operated in domestic circumstances.

Installation

Unpacking



Slide out the polythene bag with the polystyrene stuffing before using the appliance. Pull off adhesive strips from inside machine on top of drum.

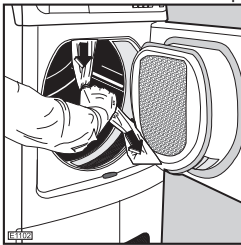

Should the appliance be moved, it must be transported vertically.



The appliance must not be installed behind a lockable door, a sliding door or a door with a hinge on the opposite side to that of the appliance.

Positioning

It is recommended that, for your convenience, the machine is positioned close to your washing machine.

The tumble dryer must be installed in a clean place, where dirt does not build up.

Air must be able to circulate freely all round the appliance. Do not obstruct the front ventilation grille or the air intake grilles at the back of the machine.

To keep vibration and noise to a

minimum when the dryer is in use, it should be placed on a firm, level surface.

Once in its permanent operating position, check that the dryer is absolutely level with the aid of a spirit level. If it is not, raise or lower the feet until it is.

The feet must never be removed. Do not restrict the floor clearance through deeppile carpets, strips of wood or



similar. This might cause heat build-up which would interfere with the operation of the appliance.

Important

The hot air emitted by the tumble dryer can reach temperatures of up to 60°C. The appliance must therefore not be installed on floors which are not resistant to high temperatures.

When operating the tumble dryer, the room temperature must not be lower than +5°C and higher than +35°C, as it may affect the performance of the appliance.

Stacking kit

A special stacking kit is available through your dealer, to enable the mounting of the dryer on top of a front loading washing machine with cover's depth between 48 and 60 cm.

Read carefully the instructions supplied with the kit.

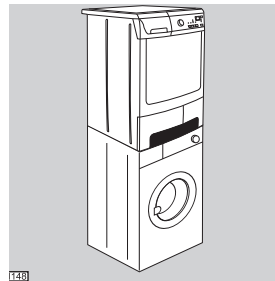

26 electrolux installation

Door reversal

To make it easier to load or unload the laundry the door can be reversed.



Reversing the door is not possible if after this operation the appliance result installed behind a door with a hinge on the opposite side to that of the appliance.

This operation must be carried out by qualified personnel.
Please contact the nearest Service Centre.

Electrical connection

Any electrical work required to install this appliance should be carried out by a qualified electrician or competent person.



WARNING: THIS APPLIANCE MUST BE EARTHED.

The manufacturer declines any liability should this safety measure not be observed.

Before switching on, make sure the electricity supply voltage is the same as that indicated on the appliance's rating plate.

The appliance is supplied with a 13amp plug fitted.

In the event of having to change the fuse in the plug supplied, a 13amp ASTA approved (BS1362) fuse must be used.

Should the plug need to be replaced for any reason, proceed as described below.

The wires in the mains lead are coloured in accordance with the following code:

- Green and Yellow - Earth
- Blue - Neutral
- Brown - Live

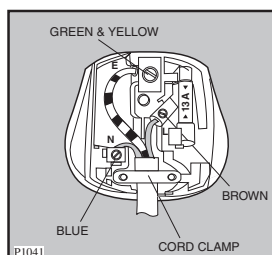

Environment concerns

Packaging materials



The materials marked with the symbol  are recyclable.

>PE<=polyethylene

>PS<=polystyrene

>PP<=polypropylene

This means that they can be recycled by disposing of them properly in appropriate collection containers.

Old machine

Use authorised disposal sites for your old appliance. Help to keep your country tidy!



The symbol  on the product or on its packaging indicates that this product may not be treated as household waste.

Instead it should be taken to the appropriate collection point for the recycling of electrical and electronic equipment. By ensuring this product is disposed of correctly, you will help prevent potential negative consequences for the environment and human health, which could otherwise be caused by inappropriate waste handling of this product. For more detailed information about recycling of this product, please contact your local council your household waste disposal service or the shop where you purchased the product.

Ecological hints



To save energy and to help protect the environment, we recommend that you follow these hints:

- Try to load the maximum capacity of the machine as small loads are uneconomical.
- Always load well spun laundry. The higher the spin speed, the lower the electricity consumption and the shorter the drying times.
- Do not over-dry laundry, this avoids creasing and saves energy. Select the drying programme according to the type of laundry and the required degree of dryness.
- To utilize the maximum load, laundry which is to be dried ready to put away (store dry) can be dried together with items to be ironed. To do this, select the programme for iron-dry, remove the iron-dry items at the end of the programme and then finish-dry the rest of the load.
- Clean the filters regularly to avoid excessive drying times and high electricity consumption.
- Ventilate the room well. The room temperature should not exceed +35°C during drying.

28 electrolux guarantee/customer service

Guarantee Conditions

Guarantee/Customer Service

Standard guarantee conditions

We, Zanussi Electrolux, undertake that if, within 12 months of the date of the purchase, this Zanussi-Electrolux appliance or any part thereof is proved to be defective by reason only of faulty workmanship or materials, we will, at our option repair or replace the same FREE OF ANY CHARGE for labour, materials or carriage on condition that:

- The appliance has been correctly installed and used only on the electricity supply stated on the rating plate.
- The appliance has been used for normal domestic purposes only, and in accordance with the manufacturer's instructions.
- The appliance has not been serviced, maintained, repaired, taken apart or tampered with, by any person not authorised by us.
- All service work under this guarantee must be undertaken by a Service Force Centre.
- Any appliance or defective part replaced shall become the Company's property.
- This guarantee is in addition to your statutory and other legal rights.

Exclusions

- Damage or calls resulting from transportation, improper use or neglect, the replacement of any light bulbs or removable parts of glass or plastic.
- Costs incurred for calls to put right an appliance which is improperly installed or calls to appliances outside the United Kingdom.
- Appliances found to be in use within a commercial environment, plus those which are

subject to rental agreements.

- Products of Zanussi Electrolux manufacture which are NOT marketed by Zanussi Electrolux.

Service and Spare Parts

In the event of your appliance requiring service, or if you wish to purchase spare parts, please contact your local Service Force Centre by telephoning:

0870 5 929929

Your telephone call will be automatically routed to the Service Force Centre covering your post code area.

For the address of your local Service Force Centre and further information about Service Force, please visit the website at

www.serviceforce.co.uk

Before calling out an engineer, please ensure you have read the details under the heading "Something Not Working".

When you contact the Service Force Centre you will need to give the following details:

1. Your name, address and post code.
2. Your telephone number.
3. Clear and concise details of fault.
4. The model and serial number of the appliance (found on the rating plate).
5. The purchase date.

Please note that a valid purchase receipt or guarantee documentation is required for in-guarantee service calls.

Customer Care

For general enquiries concerning your Electrolux appliance or for further information

on Electrolux products, please contact our Customer Care Department by letter or telephone at the address below or visit our website at www.zanussi.co.uk

Customer Care Department Major Appliances
Addington Way Luton
Bedfordshire LU4 9QQ Tel 08705 727727(*)

(*)calls to this number may be recorded for training purposes.

European guarantee

This appliance is guaranteed by Electrolux, in each of the countries listed in the following page, for the period specified in the appliance guarantee or otherwise by law. If you move from one of these countries to another of these countries the appliance guarantee will move with you subject to the following qualifications:

guarantee/customer service electrolux 29

- The appliance guarantee starts from the date you first purchased the appliance which will be evidenced by production of a valid purchase document issued by seller of the appliance.
- The appliance guarantee is for the same period and to the same extent for labour and parts as exists in your country of residence for this particular model or range of appliances.
- The appliance guarantee is personal to the original purchaser of the appliance and cannot be transferred to another user.
- The appliance is installed and used in accordance with instructions issued by Electrolux and is only used within the home, i.e. is not used for commercial purposes.
- The appliance is installed in accordance with all relevant regulations in force within your new country of residence.

The provisions of this European Guarantee do not affect any of the rights granted to you by law.

www.electrolux.com

		
Albania	+35 5 4 261 450	Rr. Pjeter Bogdani Nr. 7 Tirane
Belgique/België/ Belgien	+32 2 363 04 44	Bergensesteenweg 719, 1502 Lembeek
Česká republika	+420 2 61 12 61 12	Budějovická 3, Praha 4, 140 21
Danmark	+45 70 11 74 00	Sjællandsgade 2, 7000 Fredericia
Deutschland	+49 180 32 26 622	Muggenhofer Str. 135, 90429 Nürnberg
Eesti	+37 2 66 50 030	Mustamäe tee 24, 10621 Tallinn
España	+34 902 11 63 88	Carretera M-300, Km. 29,900 Alcalá de Henares Madrid
France	www.electrolux.fr	
Great Britain	+44 8705 929 929	Addington Way, Luton, Bedfordshire LU4 9QQ
Hellas	+30 23 10 56 19 70	4 Limnou Str., 54627 Thessaloniki

30 electrolux **guarantee/customer service**

		
Hrvatska	+385 1 63 23 338	Slavonska avenija 3, 10000 Zagreb
Ireland	+353 1 40 90 753	Long Mile Road Dublin 12
Italia	+39 (0) 434 558500	C.so Lino Zanussi, 26 - 33080 Porcia (PN)
Latvija	+37 17 84 59 34	Kr. Barona iela 130/2, LV-1012, Riga
Lietuva	+370 5 2780609	Ozo 10A, LT 08200 Vilnius
Luxembourg	+35 2 42 43 13 01	Rue de Bitbourg, 7, L-1273 Hamm
Magyarország	+36 1 252 1773	H-1142 Budapest XIV, Erzsébet királyné útja 87
Nederland	+31 17 24 68 300	Vennootsweg 1, 2404 CG - Alphen aan den Rijn
Norge	+47 81 5 30 222	Risløkkvn. 2 , 0508 Oslo
Österreich	+43 18 66 400	Herziggasse 9, 1230 Wien
Polska	+48 22 43 47 300	ul. Kolejowa 5/7, Warsaw
Portugal	+35 12 14 40 39 39	Quinta da Fonte - Edificio Gonçalves Zarco - Q 35 2774 - 518 Paço de Arcos
Romania	+40 21 451 20 30	Str. Garii Progresului 2, S4, 040671 RO
Schweiz-Suisse- Svizzera	+41 62 88 99 111	Industriestrasse 10, CH-5506 Mägenwil
Slovenija	+38 61 24 25 731	Electrolux Ljubljana d.o.o. Gerbiceva 98, 1000 Ljubljana
Slovensko	+421 2 43 33 43 22	Electrolux Slovakia s.r.o., Electrolux Domáce spotrebiče SK, Seberínho 1, 821 03 Bratislava
Suomi	www.electrolux.fi	
Sverige	+46 (0)771 76 76 76	Electrolux Service, S:t Göransgatan 143,S-105 45 Stockholm
Türkiye	+90 21 22 93 10 25	Tarlabası caddesi no : 35 Taksim İstanbul
Россия	+7 095 937 7837	129090 Москва, Олимпийский проспект, 16, БЦ „Олимпик“

www.electrolux.com

www.electrolux.co.uk

125 987 352 -00- 05102007

Free Manuals Download Website

<http://myh66.com>

<http://usermanuals.us>

<http://www.somanuals.com>

<http://www.4manuals.cc>

<http://www.manual-lib.com>

<http://www.404manual.com>

<http://www.luxmanual.com>

<http://aubethermostatmanual.com>

Golf course search by state

<http://golfingnear.com>

Email search by domain

<http://emailbydomain.com>

Auto manuals search

<http://auto.somanuals.com>

TV manuals search

<http://tv.somanuals.com>