

B11

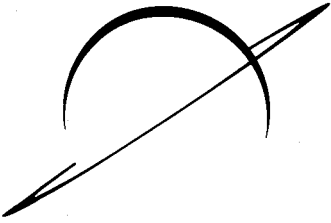

ZANUSSI

Instructions for the use and care of GC 19 cooker

Contents

Instructions for the owner

Installation	Page	3
Technical data	Page	3
Use	Page	4
Gas oven	Page	6
Analogue clock	Page	7
Oven cooking chart	Page	9-10
Maintenance & cleaning	Page	11

Instructions for the installer

Installation	Page	13
Electrical connection	Page	14
Gas connection	Page	15
Maintenance	Page	17

Caution:

Before you start operating the appliance, be sure to remove the plastic films protecting the stainless steel or anodized aluminium parts.

Important: During normal cooking operations the appliance will get very hot. Therefore, do not let children play near the appliance.

Instructions for the owner

Installation

It is mandatory that all operations required for the installation, the adjustments, the conversion to the type of gas available etc. be carried out by **QUALIFIED PERSONNEL** in accordance with existing rules and regulations.

The relevant instructions are to be found in the special chapter for the installer.

Technical data

Model	GC 19
Dimensions: height	850/900 mm
depth	600 mm
width	597 mm
Oven volume	48 dm ³
Automatic push button ignition: hob, grill + oven	YES
Safety cut off with manual reset: oven, hob + grill	YES
Oven light	15 W
Analogue clock	180 mins
Supply voltage	240V -50Hz
Gas oven burner	3,0 kW
Grill rating	2,7 kW

Use and care

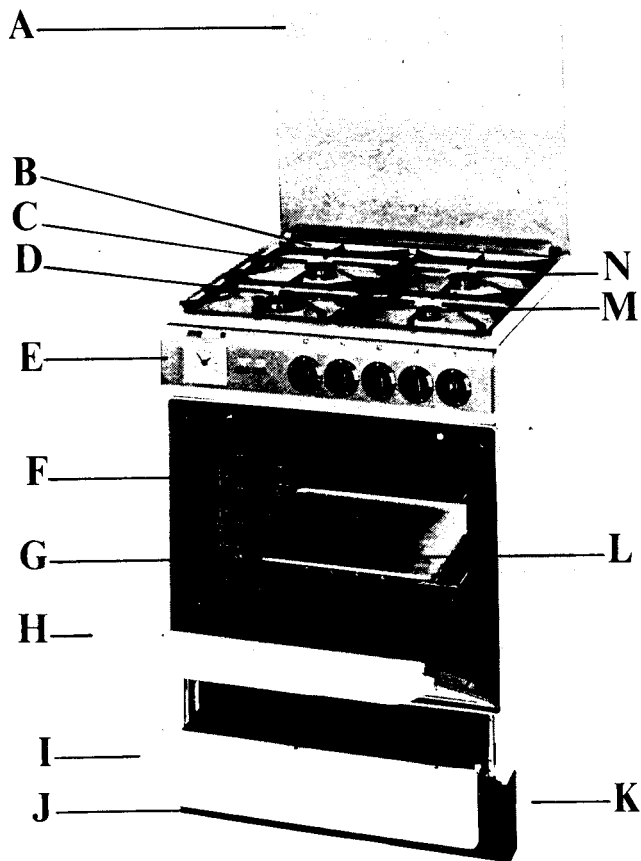

Cooker

A - Cover
B - Safety cut off
C - Semi-rapid burner
D - Rapid burner
E - Control panel
F - Shelf supports
G - Shelves

H - Oven door
I - Removable drawer
J - Front panel
K - Removable base
L - Baking tray
M - Auxiliary burner
N - Semi-rapid burner

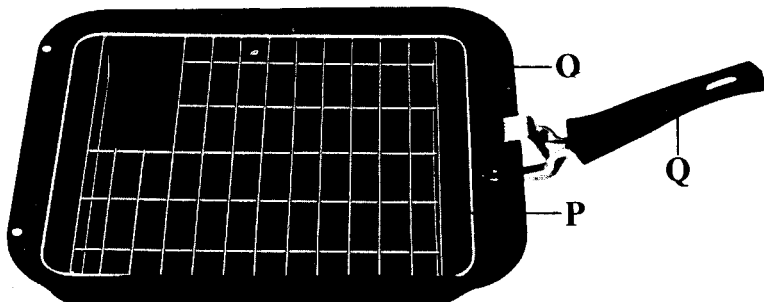

- O - Grill/Roasting pan
- P - Reversible grill pan insert
- Q - Removable handle

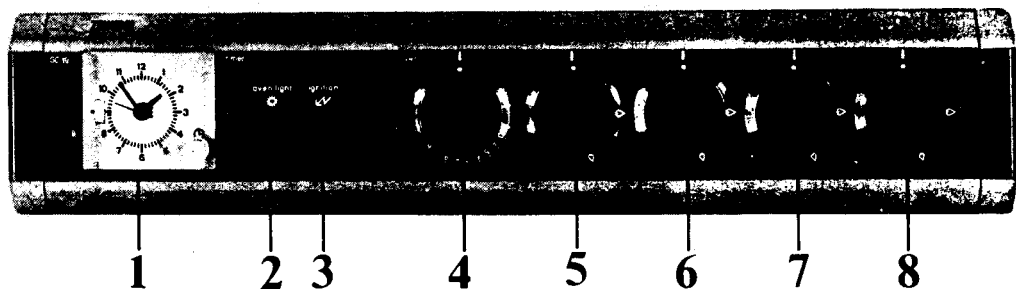

- 1. Analogue clock
- 2. Oven light switch
- 3. Lighting button
- 4. Oven knob
- 5. Semi-rapid burner knob
- 6. Rapid burner knob
- 7. Auxiliary burner knob
- 8. Semi-rapid burner knob

Operation

Safety cut off

The cooker is equipped with a safety cut off device which totally interrupts the gas supply of the worktop, oven and grill burners. By lowering the worktop cover, the gas supply is interrupted. To restore gas supply, lift up the cover and depress the black button placed on the back left of the worktop.

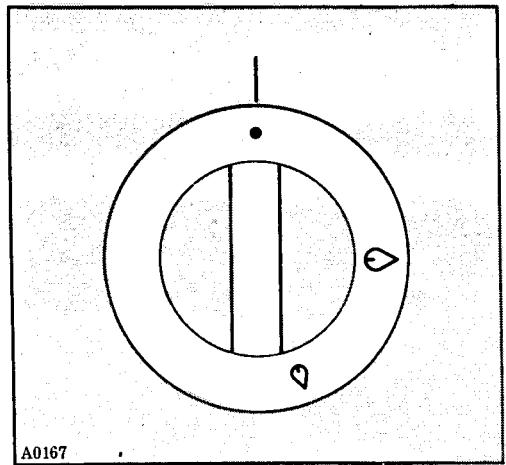

fig. 1

Worktop burners

To light a worktop burner, turn the relevant knob anticlockwise to maximum (Fig. 1).

After opening the tap to maximum, push button marked by a small electric spark. As soon as the burner is lit, adjust the flame as required.

To ensure maximum burner efficiency, it is strongly recommended that you use only pots and pans with a base fitting the size of the burner used, so that the flame will not spread beyond the base of the vessel.

It is also advisable, as soon as a liquid starts boiling, to turn down the flame so that it will barely keep the liquid simmering.

Important: Be very careful when frying food in hot oil or fat as the overheated splashes could easily flare up.

Gas oven

The oven features a small grill/roasting pan, a baking tray and two shelves. Furthermore this oven fits a device which makes the ignition of the burner easier. The instructions are the following:

1. Open the oven door.
2. Firmly depress the oven control knob (Fig. 2) and turn it anticlockwise to the maximum setting and at the same time operate on the relevant pushbutton

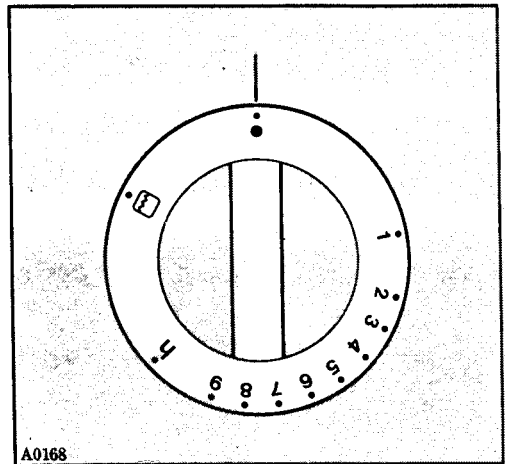

fig. 2

Oven temperature chart

Position	Temperatures	
	°F	°C
1	275	135
2	300	149
3	325	163
4	350	177
5	375	191
6	400	204
7	425	218
8	450	232
9	475	246
h	527-536	275-280

marked by a small electric spark. Keep the oven control knob depressed for 10-15 secs.

3. Release the control knob and then gently close the oven door. To adjust the temperature, after a few minutes turn the knob to the required temperature setting.

Important

Due to the position of the burner in the base of your oven it is essential that the area around the burner access flaps should be kept clean of spillage of fat and similar substances.

Gas grill

To light the grill, firmly depress the oven control knob and turn it clockwise to the symbol , then operate on the pushbutton marked by a small spark. Keep the control knob depressed for 10-15 secs; then release the grill control knob.

Oven safety device

The cooker features a thermocouple; if for any reason the flame should extinguish the device will interrupt the gas flow.

Important:

Oven and grill burner lighting is possible only if the oven door is opened.

Oven light switch

This switch will turn on the oven light.

Using the grill

Foods to be grilled are to be placed on the wire grid in the grill pan which can be used either way up to give the required distance from the burner. The pan is then placed in the required runner position.

Important

Your oven door is fitted with hinges, giving two door positions, fully open or fully closed.

When grilling, the oven door must be closed.

Grilling with the door open could cause areas of the oven and surrounding furniture to become excessively hot: as well as reducing the performance, efficiency and economy of the grill.

Analogue clock

The clock can be reset to the correct time by pulling and turning the Knob A (i.e. following a power failure).

By turning the knob A (Fig. 3) clockwise or anticlockwise, the analogue clock will show on dial B the required cooking time (max. 180 mins).

When setting a cooking time a sound signal will indicate that the cooking is over.

To stop it turn knob A clockwise until symbol «0» coincides with the index of dial B.

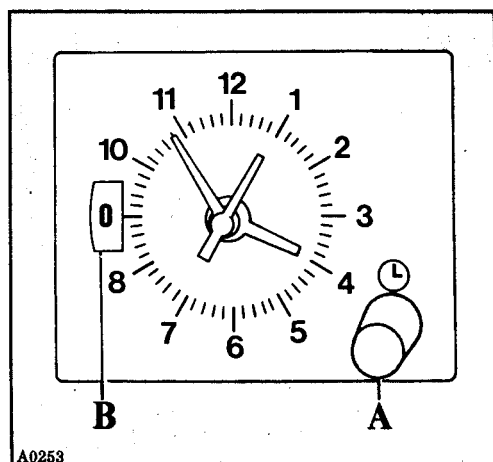

A0253

Fig. 3

Cooking instructions

The shelf positions in this oven are numbered from the base up (fig. 4), and the variations of heat between the top and bottom shelves is approximately one gas mark. It is advisable to follow the recommended shelf positions until you become familiar with your oven.

Pre-heat the oven for about 10-15 minutes to allow it to reach the required temperature.

Please remember that the heat comes directly up from the base of this oven. Care must be taken not to place food or dishes directly on to it, neither can it be used to keep dishes warm. To minimise cleaning it is advisable to avoid spilling such things as fruit juice or sugar on to the base of the oven whilst it is hot. Therefore, items such as fruit pies or crumbles are best cooked on a baking tray.

For this purpose or for baking never use a full width baking-tray that will obstruct the circulation of heat.

If you wish to bake two identical items simultaneously keep one free shelf position between them to allow maximum heat circulation. As the food on the lower shelf begins to brown on the base, change the position of the trays around to ensure that the food browns evenly.

If you are in any doubt about baking one of your own recipes, try to find something similar in our baking guide and follow its recommendations.

These times and temperatures are only approximate and for use as a guide.

You can use Gas Mark setting higher or lower to cook your food exactly as you like it.

Important

The anti-tip oven grid must be positioned as shown in figure 5.

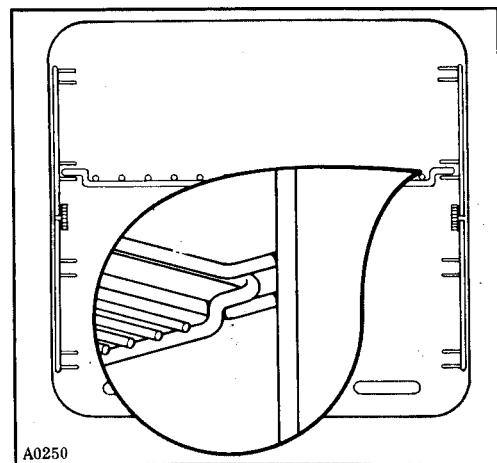
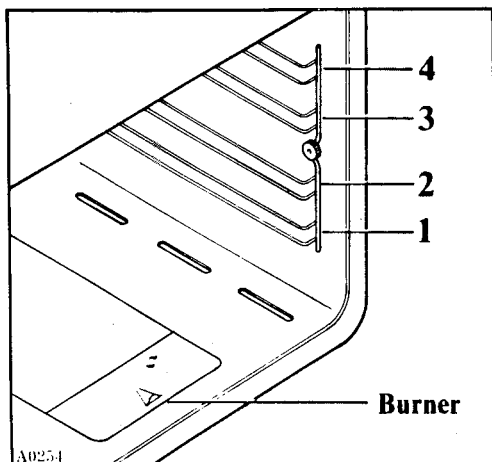

fig. 4

fig. 5

Oven cooking charts

FOOD	GAS MARK	SHELF POSITIONS	COOKING TIME
MEAT & POULTRY			
Beef with bone	4	1 or 2	20 minutes per lb + 20 minutes
Beef without bone	6	1 or 2	25 minutes per lb + 25 minutes
Lamb	4	1 or 2	20-25 minutes per lb + 20-25 minutes
Pork	5	2	25 minutes per lb + 25 minutes
Chicken	6	2	25 minutes per lb + 25 minutes
Duckling	4	2	30 minutes per lb + 30 minutes
Turkey	3	2 or 3	30 minutes per lb + 30 minutes
Casseroles	2	1 or 2	2½-3 hours
YORKSHIRE PUDDING			
Small	7	3 or 4	25 minutes
Large	7	2 or 3	35 minutes
BAKED VEGETABLES	4	2	varies according to the vegetable
PASTRY			
Fruit Tart	6	1	45 minutes
Fruit Pie	6	1 or 2	45 minutes
Sausage Rolls	7	1 and 3	30 minutes
Choux Pastry	Reg 6 for 15 minutes Reg 6 for 10 minutes	2 and 4	25-30 minutes
Vol au Vents	8	2 and 4	15 minutes
Jam Tarts	5	3 and 4	10-15 minutes

FOOD	GAS MARK	SHELF POSITIONS	COOKING TIME
PUDDINGS			
Egg Custard in a Bain Marie	1	1	1-1 ¼ hours
Pavlova	1	2 or 3	1 ½ hours
Meringues	1	2 and 4	1 ½ hours
CAKES			
Rich Fruit Cake 8"	Reg 1 for 2 hours Reg 2 for remainder	2 or 3	3 ½-4 hours
Plain Fruit Cake	3	2 or 3	2 ½ hours
Victoria Sandwich	5	3 and 4	25 minutes
Madeira Cake	3	2 or 3	1 ¾-2 hours
Fairy Cakes	4	3 and 4	30 minutes
Ginger Bread	4	3	45 minutes
Flapjack	4	3	25-30 minutes
YEAST MIXTURES			
Bread 1lb Loaves	7	3	30-35 minutes
Bread 2lb Loaves	7	3	40-45 minutes
Rolls and Buns	7	2 or 3	15-20 minutes
Tea Rings	6	2 or 3	24-35 minutes
Scones	6	3 and 4	15-20 minutes
Shortbread	4	2 or 4 Change trays over halfway through the cooking time	25-30 minutes

Maintenance

For a long service life of the appliance we strongly recommend that you frequently carry out a thorough cleaning operation.

Cleaning the oven

(without panels)

Always wait until the oven is cool before cleaning.

It is advisable to release the shelf supports.

All enamelled parts should be washed with lukewarm water and detergent without using abrasive products which might damage them.

The oven should be cleaned inside with the greatest care, after each use, with hot water and detergent (or one of the special products available on the market).

When cleaning the oven, be careful to protect the aluminium parts of the control panel from chemical compounds contained in the products used to clean the enamelled parts.

Removing the panels (optional extra)

If you have purchased the panels as an optional extra proceed as follows:

Unscrew the ring nuts securing the side grilles (Fig. 6), remove the grilles and then remove the side panels (Fig. 7).

Cleaning the worktop

Burner caps should be frequently washed in hot water and detergent, being careful to remove all incrustations.

Thoroughly clean the terminal part of the automatic lighting device to ensure easy lighting and make sure that the flame spreader gas openings are unobstructed.

Stainless steel parts should be carefully rinsed with water, after each use, and then dried with a clean soft cloth.

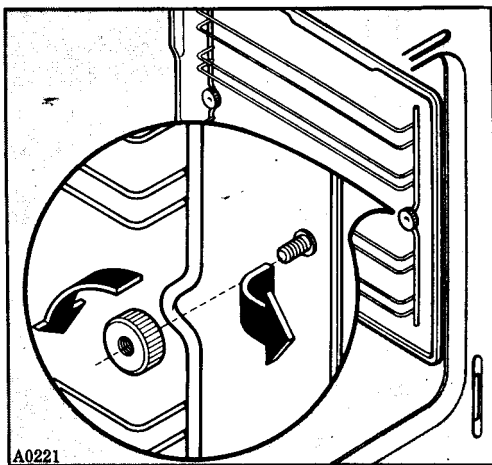

fig. 6

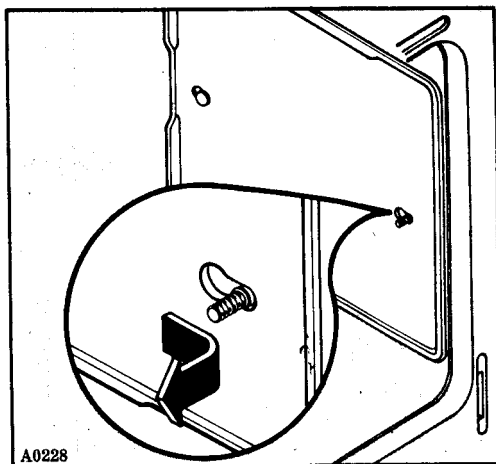

fig. 7

In the case of persistent spots you may use normal non-abrasive detergents, currently available on the market.

Never use steel-wool pads, chlorine or similar products which might scratch, grind or etch the metal.

To clean the cover use liquid or creamy detergents, thus avoiding the use of powder abrasives, rough sponges or steel wool.

Also, never close the cover while the burners are still warm.

Replacing the oven lightbulb

Disconnect the appliance from the electric supply.

Unscrew the lightbulb glass protection from the oven. Unscrew the lightbulb and replace it with a new bulb suitable for high temperature (300 °C) and having the following technical features:

Operating voltage: 240V - 50 Hz

Power absorbed: 15 W

Available from your local service centre

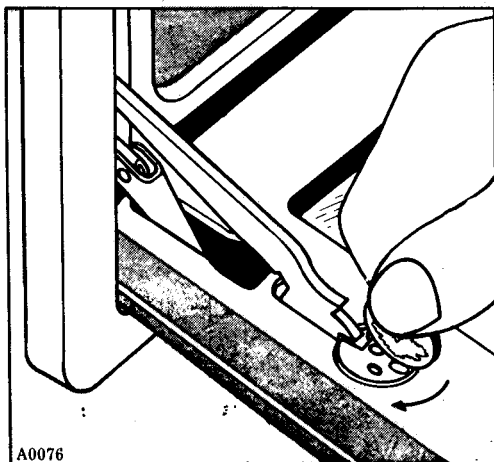

A0076

fig. 8/A

Removing the oven door (Fig. 8 A, B, C)

1. Open the oven door so that it is in the horizontal position.
2. With the aid of a coin move the two retaining discs a quarter turn to the left, so that the two raised bars are to the left hand side of the hinges.

3. Raise the door halfway.

4. At this stage the two hinges on either side of the door must be clasped together simultaneously. The door can then be removed by pulling out and downwards, maintaining the angle.

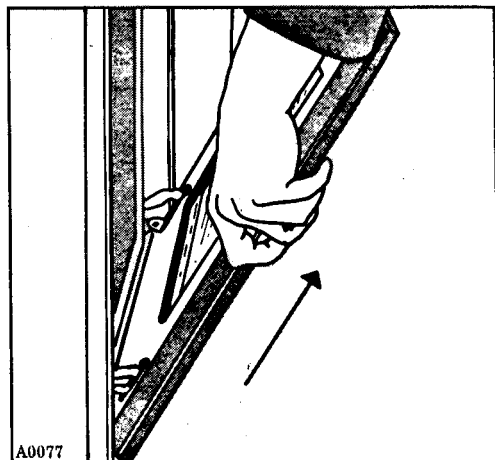

A0077

fig. 8/B

To replace the door:

1. Clasp the two hinges on either side of the door together simultaneously.
2. Hook the top hinge into the top slot so that the hook is engaged with the roller.
3. Drop the lower hinge into the lower slot, so that the notch is engaged. Drop the door down so it is in the horizontal position.

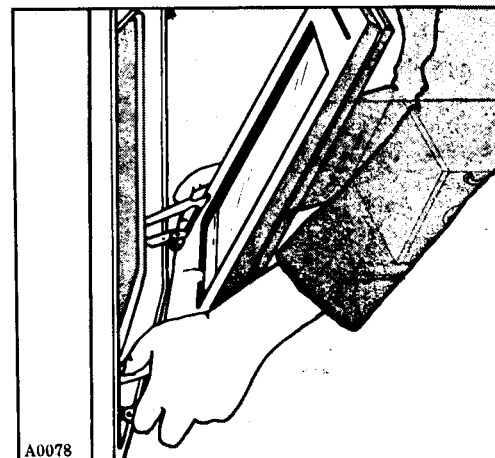

A0078

fig. 8/C

NOTE: It is very important when carrying out this operation that both hinges should be located simultaneously.

4. Turn the retaining discs back a quarter turn so that the two raised bars are opposite the hinges. The door can then be closed.

Instructions for the installer

Installation

The following instructions are meant for a qualified installer and should assist him in carrying out all installation, adjustment and maintenance operations in the most correct way and in accordance with existing laws and regulations.

Important:

Before servicing the appliance or undertaking any maintenance work on it, be sure to disconnect it from the electric supply. Should it be absolutely necessary to keep the appliance «live» take all possible precautions to prevent accidents.

Positioning

To ensure a troublefree operation of the appliance, it is a must that it be set up in a well ventilated kitchen (in this connection, the installer needs only comply with existing rules and regulations). The cooker may be positioned in such a way as to come into touch with the sides of the kitchen furniture. However, the latter must be able to withstand a temperature increase of 60 °C.

The appliance incorporates a removable base (A - Fig. 9-10) which permits the alignment with kitchen furniture having a height of 85 cms, plus levelling feet (B - Fig. 9-10).

To remove the metal base rest the appliance on a side, slide out the front plastic panel (C - Fig. 9) which is push-fitted and then unscrew the six screws (D - Fig. 9) that secure the base to the cabinet.

Remove the levelling feet from the base (B - Fig. 9-10), screw them onto the cabinet and then fit the new front panel (optional) (E - Fig. 10).

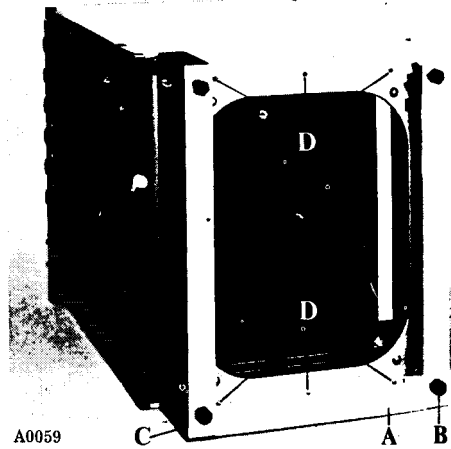

A0059
fig. 9

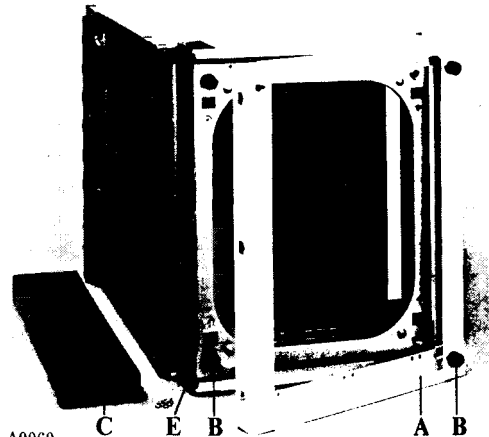

A0060
fig. 10

Position the appliance.

The appliance incorporates a set of adjustable feet.

By properly adjusting the feet, the appliance can be set up at the required height and correctly aligned with the kitchen furniture or any other surface, thus ensuring an even spreading out of liquids in pans and pots.

These adjustable feet are easily accessible after removing the dish-warming drawer.

To remove this drawer, proceed as follows:

pull out the drawer to the limit stop in order to slide out completely the side runners:

shift the front rollers up to the «buttonholes» of the side runners;

lift up the drawer and slide out the front rollers;

pull out the drawer and shift the rear rollers up to the «buttonholes» of the side runners;

lift up the drawer and slide out the rear rollers;

To replace the drawer, reverse the above procedure.

The electrical connections

WARNING: THIS APPLIANCE MUST BE EARTHED.

The manufacturer declines any liability should this safety measure not be observed.

If the plug that is fitted to your appliance is not suitable for your socket outlet, it must be cut off and the appropriate plug fitted. The cut off plug should be disposed of to prevent the hazard of electric shocks in case it should be plugged into a 13 Amp socket in another part of your home.

IMPORTANT: The wires in this mains lead are coloured in accordance with the following code:

GREEN AND YELLOW - EARTH
BLUE - NEUTRAL
BROWN - LIVE

If you fit your own plug, the colours of the wires in the mains lead of your appliance may not correspond with the markings identifying the terminals in your plug, this is what you have to do:

Connect the green and yellow (earth) wire to the terminal in the plug which is marked with the letter «E» or the earth symbol \oplus or coloured green, or green and yellow.

Connect the blue (neutral) wire to the terminal in the plug which is marked with the letter «N» or coloured black.

Connect the brown (live) wire to the terminal which is marked with the letter «L» or coloured red.

The plug moulded on to the cord incorporates a fuse. For replacement, use a 13 Amp BS 1362 fuse. Only ASTA approved fuses should be used.

The fuse cover/carrier must be replaced in the event of changing fuse.

The right fuse cover/carrier colour is the one shown by the coloured insert at the base of the plug.

The plug must not be used if the fuse

cover/carrier is lost.

A replacement cover/carrier must be obtained from Zanussi Service Agents whose addresses are listed on the attached «Zanussi Service and Spares Nationwide».

This appliance complies with E.E.C. directive No. 82/499 of 7.6.82 relative to radio interference suppression.

Important

The heat insulation of the oven and grease residues from the manufacturing process produce smoke and an unpleasant smell during the first minutes of operation.

It is therefore advisable, the first time the appliance is used, to pre-heat the oven for about 30 mins. at peak temperature without putting any food into it.

Gas connection

Connect the cooker to the gas mains, in accordance with existing rules and regulations.

Important: To ensure a safe operation, a lower consumption and a longer service life of the appliance, make sure that the feed pressure is in accordance with the specifications given in the «burner and nozzle features chart».

Rigid pipe connection

In case of connection to the gas mains by means of a metal pipe & fittings, make sure that this does not put any strain on the appliance.

The cooker has a ½" threaded gas inlet.

Attention: The cooker is adjusted for NATURAL GAS (METHANE) and cannot be converted for use with LPG.

Burner and Nozzle Features Chart

Burner	Nominal Power		Natural gas (Methane)	
	kC	kW	Nozzle	l/h 15°C
Small (dia. 40 mm)	860	1,0	79	95
Medium (dia. 60 mm)	1700	2,0	110	190
Big (dia. 90 mm)	2800	3,2	140	304
Oven	2600	3,0	120	288
Grill	2300	2,7	115	255
Feed Pressure	nom. (mbar)*		20	
	min. (mbar)*		18	
	max. (mbar)*		25	

*1 mbar = 10 mm water column.

Taps

Burner	Dia. Tap By-Pass	Tap colour
Small	42	Red
Medium	45	Yellow
Big	55	Black

Oven Thermostat

By-pass Pin Dia.	Natural gas
	0.70

Maintenance

Check at regular intervals the condition and serviceability of the gas connection hose in case of malfunction, do not repair but replace the whole faulty part.

To ensure a smooth and safe operation, it is necessary to periodically grease the gas taps.

Servicing should be carried out by qualified personnel as follows:

Remove the knobs and slide out the front panel after removing the securing screws. Unscrew the two screws to be found next to the gas tap shaft.

Slide out the cone and clean it thoroughly; finally, apply a thin layer of grease of a type non-soluble to hydrocarbons and suitable for gas taps.

Make sure that no excess grease obstructs the gas tap holes.

Refit everything very carefully reversing the above procedure.

ZANUSSI GUARANTEE CONDITIONS

This guarantee is in addition to your statutory and other legal rights which will not be excluded or in any way diminished by the return of the enclosed card.

We, Zanussi Limited, guarantee that if within twelve months of the date of the purchase, this ZANUSSI appliance or any part thereof is proved to be defective by reason only of faulty workmanship or materials we will at our option repair or replace the same **FREE OF ANY CHARGE** for labour, materials or carriage on condition that:

- The appliance has been correctly installed and used only on the electricity supply stated on rating plate.
- The appliance has been used for normal domestic purposes and in accordance with the manufacturer's operating and maintenance instructions.
- The appliance has not been serviced, maintained, repaired, taken apart or tampered with by any person not authorised by us.

- The appliance is still in the possession of the original purchaser.
- Any appliance or defective part replaced shall become our property.

This guarantee does not cover any damage caused during transportation or the replacement of any light bulbs or removable parts of glass or plastic.

Should you require service on your Zanussi appliance consult the enclosed list for your nearest network centre. If the product is under first year guarantee then you will be required to produce proof of date of purchase to the engineer. If it is under 5 year cover then you must show your cover card to the engineer.

Please ensure that the enclosed pre-addressed card is stamped, completed in full and forwarded to Zanussi Limited, to enable the guarantee to be recorded. Also complete the space below as your own record of the guarantee.

GUARANTEE RECORD

Appliance purchased from _____ on _____
Guarantee card no _____ Model no _____
Serial no _____ (These details may be taken from your Guarantee Record Card)
Your name _____
Address _____

Free Manuals Download Website

<http://myh66.com>

<http://usermanuals.us>

<http://www.somanuals.com>

<http://www.4manuals.cc>

<http://www.manual-lib.com>

<http://www.404manual.com>

<http://www.luxmanual.com>

<http://aubethermostatmanual.com>

Golf course search by state

<http://golfingnear.com>

Email search by domain

<http://emailbydomain.com>

Auto manuals search

<http://auto.somanuals.com>

TV manuals search

<http://tv.somanuals.com>