

EN User manual

2

Ceramic glass induction hob

USER MANUAL

ZIT64X

ZANUSSI

Get Living!

Contents

Safety information _____	2	Helpful hints and tips _____	8
Installation _____	3	Care and cleaning _____	9
Description of the appliance _____	5	What to do if... _____	10
Operating the appliance _____	6	Environment concerns _____	11

Subject to change without notice

Safety information

 For your safety and correct operation of the appliance, read this manual carefully before installation and use. Always keep these instructions with the appliance even if you move or sell it. Users must fully know the operation and safety features of the appliance.

General safety

 **Warning!** Persons (including children) with reduced physical sensory, mental capabilities or lack of experience and knowledge must not use the appliance. They must have supervision or instruction for the operation of the appliance by a person responsible for their safety.

Child safety

- Only adults can use this appliance. Children must get supervision to make sure that they do not play with the appliance.
- Keep all packaging away from children. There is a risk of suffocation.
- Keep children away from the appliance when it is on.

 **Warning!** Start the child safety device to prevent small children and pets from an accidental activation of the appliance.

Safety during operation

- Remove all packaging, stickers and layers from the appliance before the first use.
- Set the cooking zones to "off" after each use.
- Risk of burns! Do not put metallic objects, for example cutlery or saucepan lids, on the cooking surface, as they can become hot.
- Users with an implanted pacemaker must keep their upper body minimum 30 cm from induction cooking zones that are switched on.

 **Warning! Fire danger!** Overheated fats and oils can catch fire very quickly.

Correct operation

- Always monitor the appliance during operation.
- Only use the appliance for domestic cooking tasks!
- Do not use the appliance as a work or a storage surface.
- Do not put or keep very flammable liquids and materials, or fusible objects (made of plastic or aluminium) on or near the appliance.
- Be careful when you connect the appliance to the near sockets. Do not let electricity bonds touch the appliance or hot cookware. Do not let electricity bonds tangle.

How to prevent a damage to the appliance

- If the objects or cookware fall on the glass ceramic, the surface can be damaged.
- Cookware made of cast iron, cast aluminium or with damaged bottoms can scratch the glass ceramic if you move them on the surface.
- Do not let cookware boil dry to prevent the damage to cookware and glass ceramics.
- Do not use the cooking zones with empty cookware or without cookware.
- Do not cover the parts of the appliance with aluminium foil.
- Do not cover the ventilation space of 5 mm between the worktop and front of the unit below it.



 **Warning!** If there is a crack on the surface, disconnect power supply to prevent the electric shock.

Installation

i Before the installation, note down this data from the rating plate:

- Model description (Modell).....
- Product number (Prod. Nr.)
- Serial number (Ser. Nr.)

You find the rating plate of the appliance on its lower casing.

Modell ZIT64X	Prod.Nr. 949 594 115 00	
Typ 58 GAD D5 AU	220-240 V 50-60-Hz	Induction 7,4 kW
Made in Germany	Ser.Nr.	7,4 kW
ZANUSSI	 	

Safety instructions

! **Warning!** You must read these!

Make sure that the appliance is not damaged because of transportation. Do not connect a damaged appliance. If it is necessary, speak to the supplier. Only an authorised service technician can install, connect or repair this appliance. Use only original spare parts. Only use built-in appliances after you assemble the appliance into correct built-in units and work surfaces that align to the standards.

Do not change the specifications or modify this product. Risk of injury and damage to the appliance.

Fully obey the laws, ordinances, directives and standards in force in the country where you use the appliance (safety regulations, recycling regulations, electrical safety rules etc.)!

Keep the minimum distances to other appliances and units!

Install anti-shock protection, for example install the drawers only with a protective floor directly below the appliance!

Protect the cut surfaces of the worktop against moisture with a correct sealant!

Seal the appliance to the work top with no space left with a correct sealant!

Protect the bottom of the appliance from steam and moisture, e.g. from a dishwasher or oven!

Do not install the appliance adjacent to doors and below windows! If not, hot cookware can be hit off the hob when you open doors or windows.

! **Warning!** Risk of injury from electrical current. Carefully obey the instructions for electrical connections.

- The electrical mains terminal is live.
- Make electrical mains terminal free of voltage.
- Install correctly to give anti-shock protection.
- Loose and incorrect plug and socket connections can make the terminal become too hot.
- A qualified electrician must install the clamping connections correctly.
- Use a strain relief clamp on cable.
- Use the correct mains cable of type H05BB-F Tmax 90°C (or higher) for a single-phase or two-phase connection.
- Replace the damaged mains cable with a special cable (type H05BB-F Tmax 90°C; or higher). Speak your local Service Force Centre.

The appliance must have the electrical installation which lets you disconnect the appliance from the mains at all poles with a contact opening width of minimum 3 mm. You must have correct isolation devices: line protecting cut-outs, fuses (screw type fuses removed from the holder), earth leakage trips and contactors.

Assembly

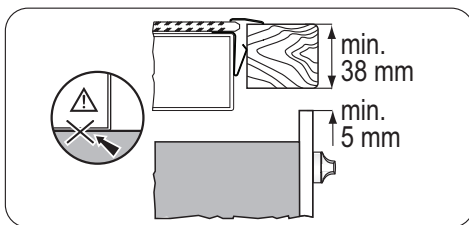
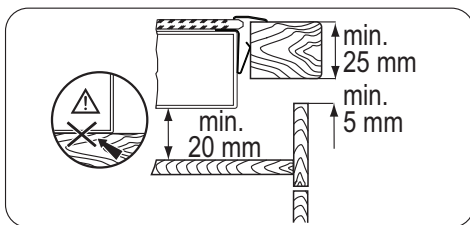
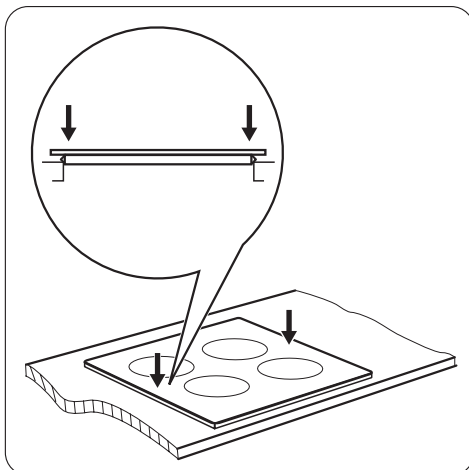
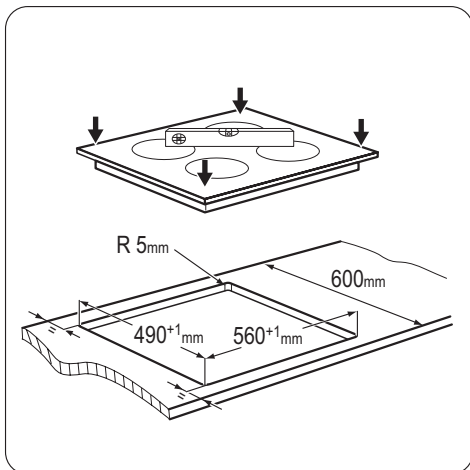
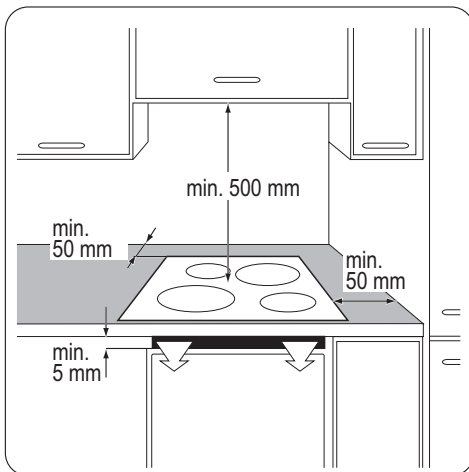
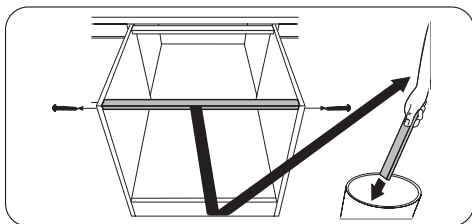

Description of the appliance

Cooking surface layout

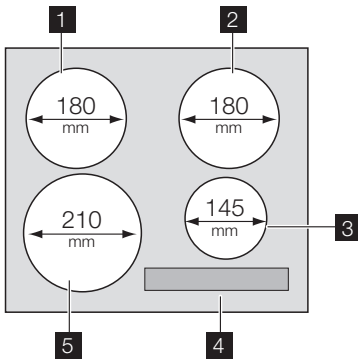

- 1** Induction cooking zone 1800W
- 2** Induction cooking zone 1800W
- 3** Induction cooking zone 1400 W, with Power function 2500W
- 4** Control panel
- 5** Induction cooking zone 2300W, with the Power function 3700W

Control panel layout

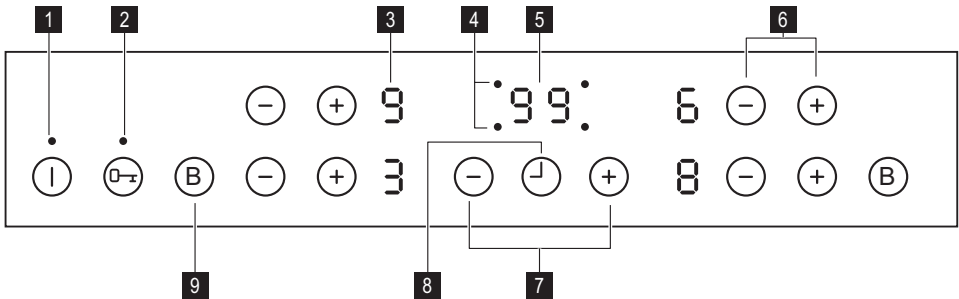

Use the sensor fields to operate the appliance.

	sensor field	function
1	①	starts and stops the hob
2	Ⓛ with an indicator	locks/unlocks the control panel
3	a heat setting display	shows the heat setting
4	cooking zones' indicators of timer	shows for which zone you set the time
5	the timer display	shows the time in minutes
6	+ / -	increase or decrease heat setting
7	+ / -	increase or decrease the time
8	⌵	selects the cooking zone
9	Ⓑ	activates the Power function

Heat setting displays

Displays and sounds tell which functions are started

Display	Description
	The cooking zone is off
	The cooking zone operates
	Keep warm setting is on
	The Automatic heat up function is on
	The induction cooking zone does not sense the cookware
	There is a malfunction
	A cooking zone is still hot (residual heat)
	Lock/Child safety device is on
	Power function is active
	The automatic switch off is active

Residual heat indicator

Warning! Risk of burns from residual heat!

The induction cooking zones make the heat necessary for cooking directly in the bottom of the cookware. The glass

ceramic is slightly heated by the residual heat of the cookware.

Operating the appliance

Use the induction cooking zones with suitable cookware.

On and Off

Touch for 1 second to start or stop the appliance.

Automatic Switch Off

The function stops the hob automatically and if:

- all cooking zones are off .
- you do not set the heat setting after you start the hob.
- you cover a sensor field with an object (a pan, a cloth, etc.) for longer than 10 seconds. The sound operates until you remove the object.

- the hob gets too hot (e.g. when a saucepan boils dry). Before you use the hob again, the cooking zone must be cool.
- you use incorrect cookware. comes on in the display and after 2 minutes the cooking zone stops automatically.
- you do not stop a cooking zone or change the heat setting. After some time comes on and the hob stops. See the table.

Automatic Switch Off times

Heat setting	-	-		-
Stops after	6 hours	5 hours	4 hours	1.5 hours

The heat setting

Touch \oplus to increase the heat setting. Touch \ominus to decrease the heat setting. The display shows the heat setting.

The automatic heat up function

The automatic heat up function adds more power to the cooking zones and you can get a necessary heat setting in a shorter time. The automatic heat up function starts when you set a heat setting starting from $\boxed{0}$. A cooking zone operates with the maximum power for some time and then automatically switches back to the heat setting you set.

If you set a higher heat setting during the automatic heat up (for example from $\boxed{3}$ to $\boxed{5}$), the automatic heat up adjusts.

If there is still residual heat on the cooking zone (display \boxed{H}), the automatic heat up does not start.

The time of the automatic heat up changes for different heat settings:

Touch \oplus and \ominus at the same time to switch off the cooking zone.

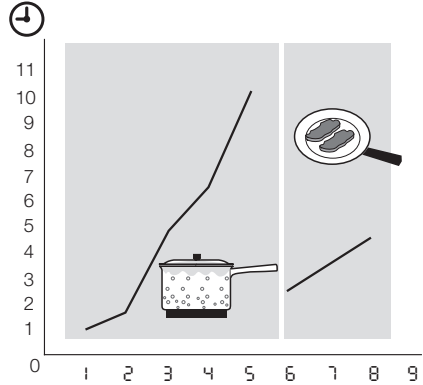

Switching the Power function on and off

The Power function makes more power available to the induction cooking zones. The Power function is activated for 10 minutes at most. After that the induction cooking zone automatically switches back to the highest heat setting. To switch on, touch \boxed{B} , \boxed{P} comes on. To switch off, touch \boxed{B} or \ominus .

Power management

The power management divides the power between two cooking zones in a pair (see the figure). The power function increases the power to the maximum level for one cooking zone in the pair and automatically decreases in the second cooking zone to a lower power level. The display for the reduced zone alternates.

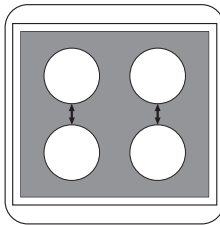

Using the Timer

Use the timer to set how long the cooking zone operates for one cooking session.

Set the timer after the selection of the cooking zone.

You can set the heat setting before or after you set the timer.



- **Selection of the cooking zone:** touch \downarrow again and again until the indicator of a necessary cooking zone comes on.
- **Starting or changing the timer:** touch \oplus or \ominus of the timer to set the time ($00 - 99$ minutes). When the indicator of the cooking zone flashes slower, the time counts down.
- **Stopping the timer:** select the cooking zone with \downarrow and touch \ominus to switch off the timer. The remaining time counts backwards to 00 . The indicator of the cooking zone goes out.
- **Checking the remaining time:** select the cooking zone with \downarrow . The indicator of the cooking zone flashes faster. Display shows the remaining time.

When the time elapses, the sound operates and 00 flashes. The cooking zone switches off.

- **Stopping the sound:** touch \downarrow . You can use the timer as a **minute minder** while cooking zones do not operate. Touch \downarrow . Touch \oplus or \ominus of the timer to select the time. When the time elapses, the sound operates and 00 flashes.

Locking / unlocking the control panel

You can lock the control panel, but not . It prevents an accidental change of the heat setting during a cooking session.

Touch the symbol . The symbol  comes on for 4 seconds.

The Timer still operates.

Touch the symbol  to switch off this function. The heat setting that you set before comes on.

When you switch off the appliance, you also switch off this function.

The child safety device

This function prevents an accidental operation of the hob.

Starting the child safety device

- Start the hob with . **Do not set the heat settings.**

Helpful hints and tips

Cookware for induction cooking zones

Important! In induction cooking a powerful electromagnetic field generates an almost instant heat inside the cookware.

Cookware material



- **correct:** cast iron, steel, enamelled steel, stainless steel, a multi-layer bottom (marked as correct by a manufacturer).
- **not correct:** aluminium, copper, brass, glass, ceramic, porcelain.

Cookware is correct for an induction hob if ...





- ... some water boils very quickly on a zone set to the highest heat setting..
- ... a magnet pulls on to the bottom of the cookware.

 **The bottom of the cookware** must be as thick and flat as possible.





Cookware dimensions : induction cooking zones adapt to the dimension of the bottom of the cookware automatically to some limit. But, the magnetic part of the bottom of the cookware must have a minimum diameter of approximately 3/4 of the cooking zones.

- Touch  until the acoustic signal. . The symbol  comes on. Switch off the appliance.

Switching off the child safety device

- Start the hob with .  comes on. Touch  until the acoustic signal.  comes on
- Switch off the appliance.

Overriding the child safety device for one cooking session

- Start the hob with . The symbol  comes on.
- Touch  until the acoustic signal. The symbol  comes on. **Set the heat setting in less than 10 seconds.** You can operate the hob. When you stop the hob with , the child safety device operates again.

Operating noises

If you can hear

- cracking noise: cookware is made of different materials (Sandwich construction).
- whistling: you use one or more cooking zones with high power levels and the cookware is made of different materials (Sandwich construction).
- humming: you use high power levels.
- clicking: electric switching occurs.
- hissing, buzzing: the fan operates.

The noises are normal and do not refer to any defects.

Energy saving

-  • If possible, always put the lids on the cookware.
- Put cookware on a cooking zone before you start it.

Examples of cooking applications

The data in the table is for guidance only.

Heat setting	Use to:	Time	Hints
U 1	Keep cooked foods warm	as required	Cover
1-2	Hollandaise sauce, melt: butter, chocolate, gelatine	5-25 min	Mix occasionally
1-2	Solidify: fluffy omelettes, baked eggs	10-40 min	Cook with a lid on
2-3	Simmer rice and milkbased dishes, heating up ready-cooked meals	25-50 min	Add at least twice as much liquid as rice, stir milk dishes part way through
3-4	Steam vegetables, fish, meat	20-45 min	Add a few tablespoons of liquid
4-5	Steam potatoes	20-60 min	Use max. ¼ l water for 750 g of potatoes
4-5	Cook larger quantities of food, stews and soups	60-150 min	Up to 3 l liquid plus ingredients
6-7	Gentle fry: escalope, veal cordon bleu, cutlets, rissoles, sausages, liver, roux, eggs, pancakes, doughnuts	as required	Turn halfway through
7-8	Heavy fry, hash browns, loin steaks, steaks	5-15 min	Turn halfway through
9	Boil large quantities of water, cook pasta, sear meat (goulash, pot roast), deep fry chips		

The Power function is suitable for heating large quantities of water.

Information on acrylamides

Important! According to the newest scientific knowledge, if you brown food (specially the one which contains

starch), acrylamides can pose a health risk. Thus, we recommend that you cook at the lowest temperatures and do not brown food too much.

Care and cleaning

Clean the appliance after each use.
Always use cookware with clean bottom.

 **Warning!** Sharp objects and abrasive cleaning agents will damage the appliance.

For your safety, do **not** clean the appliance with steam blasters or high-pressure cleaners.

 Scratches or dark stains on the glass ceramic have no effect on how the appliance operates.

Removing the dirt:

1. – **Remove immediately:** melting plastic, plastic foil, and food containing sugar. Use a special glass

ceramic scraper. Put the scraper on the glass ceramic surface at an acute angle and slide the blade on the surface.

- **Stop the appliance and let it cool down** before you clean: limescale rings, water rings, fat stains, shiny metallic discolorations. Use a special cleaner for glass ceramic or stainless steel.
2. Clean the appliance with a damp cloth and some detergent.
 3. At the end **rub the appliance dry with a clean cloth.**

What to do if...

Problem	Possible cause and remedy
You cannot start the appliance or operate it.	<ul style="list-style-type: none"> You touched 2 or more sensor fields at the same time. Only touch one sensor field. There is water or fat stains on the control panel. Clean the control panel. The child safety device or key lock operates. See the chapter Operating the appliance. Start the appliance again and set the heat setting in 10 seconds.
The cooking zone reduces the heat setting to [D]	You covered one or more sensor fields or there is water or fat stains on the control panel. Uncover the sensor fields. Clean the control panel.
A sound operates when the appliance is off.	You covered one or more sensor fields. Uncover the sensor fields.
The residual heat indicator does not come on.	The cooking zone is not hot because it operated only for a short time. If the cooking zone is supposed to be hot, speak to the After Sales Service.
Heat setting alternates	The Power management is active. See the section Power management.
A sound operates and appliance starts and stops again. After 5 seconds one more sound operates.	You covered [I] . Uncover the sensor field.
[C] comes on	<ul style="list-style-type: none"> The automatic switch-off operates. Stop the appliance and start it again. Overheating protection for the cooking zone operates. Switch off the cooking zone. Switch on the cooking zone again.
[F] comes on	<ul style="list-style-type: none"> No cookware on the cooking zone. Put cookware on the cooking zone. Not correct cookware. Use the correct cookware. The diameter of the bottom of the cookware is too small for the cooking zone. Move cookware to a smaller cooking zone.
[E] and number come on.	There is an error in the appliance. Disconnect the appliance from the electrical supply for some time. Disconnect the fuse from the electrical system of the house. Connect again. If [E] comes on again, speak to the After Sales Service.
[E4] come on	There is an error in the appliance, because a cookware boils dry or you use not correct cookware. Overheating protection for the cooking zone operates. The automatic switch-off operates. Switch off the appliance. Remove the hot cookware. After approximately 30 seconds switch on the cooking zone again. [E4] should disappear, residual heat indicator can stay. Cool down the cookware and check it with the section Cookware for the induction cooking zone.

If you tried the above solutions and cannot repair the problem, speak to your dealer or the Customer Care Department. Give the data from the rating plate, three-digit-letter code for the glass ceramic (it is in the corner of the cooking surface) and an error message that comes on.

If you operated the appliance incorrectly, the servicing by a customer service technician or dealer will not be free of charge, even during the warranty period. The instructions about the customer service and conditions of guarantee are in the guarantee booklet.

Environment concerns

The symbol  on the product or on its packaging indicates that this product may not be treated as household waste. Instead it should be taken to the appropriate collection point for the recycling of electrical and electronic equipment. By ensuring this product is disposed of correctly, you will help prevent potential negative consequences for the environment and human health, which could otherwise be caused by inappropriate waste handling of this product. For more detailed

information about recycling of this product, please contact your local council, your household waste disposal service or the shop where you purchased the product.

Packaging material



The packaging materials are friendly to the environment and can be recycled. The plastic components are identified by marking: >PE<, >PS<, etc. Discard the packaging materials as household waste at the waste disposal facilities in your municipality.

To buy accessories, consumables and spare parts at our online shop please visit:
www.zanussi.co.uk

892935156-A-092009

Free Manuals Download Website

<http://myh66.com>

<http://usermanuals.us>

<http://www.somanuals.com>

<http://www.4manuals.cc>

<http://www.manual-lib.com>

<http://www.404manual.com>

<http://www.luxmanual.com>

<http://aubethermostatmanual.com>

Golf course search by state

<http://golfingnear.com>

Email search by domain

<http://emailbydomain.com>

Auto manuals search

<http://auto.somanuals.com>

TV manuals search

<http://tv.somanuals.com>