

**User
information**

**Ceramic glass
hob**

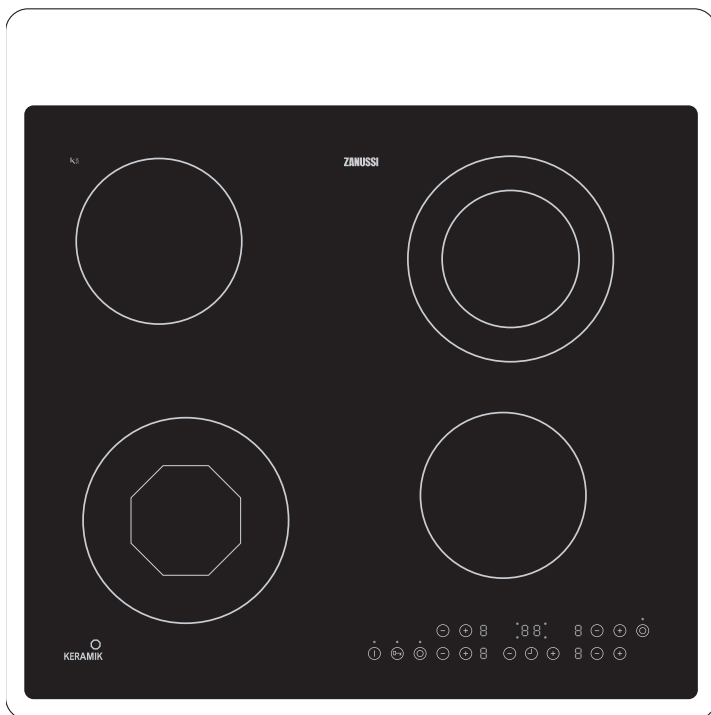

ZVH 66 F

Thank you for selecting our appliance

We wish you lots of enjoyment with your new appliance and we hope that you will consider our brand again when purchasing household appliances. Please read this user manual carefully and keep it throughout the product life cycle as a reference document. The user manual should be passed on to any future owner of the appliance.

Contents

| | | | |
|--|----|-------------------------------------|----|
| Operating Instructions - - - - - | 3 | What to do if ... - - - - - | 18 |
| Safety instructions - - - - - | 3 | Disposal - - - - - | 19 |
| Description of the Appliance - - - - - | 4 | Installation Instructions - - - - - | 20 |
| Operating the appliance - - - - - | 7 | Assembly - - - - - | 21 |
| Tips on Cooking and Frying - - - - - | 15 | Service - - - - - | 27 |
| Cleaning and Care - - - - - | 17 | | |

The following symbols are used in this user information:

 Warning! This must be read! Important advice for the safety of persons and information on avoiding damage to the appliance

 General information and advice

 Information on environmental protection

 Dangerous voltage

Operating Instructions

Safety instructions

Please comply with these instructions. If you do not, any damage resulting is not covered by the warranty.

Correct use

- This appliance is not intended for use by children or other persons whose physical, sensory or mental capabilities or lack of experience and knowledge prevents them from using the appliance safely without supervision or instruction by a responsible person to ensure that they can use the appliance safely.
- Do not leave the appliance unattended during operation.
- This appliance should be used only for normal domestic cooking and frying of food.
- The appliance must not be used as a work surface or as a storage surface.
- Additions or modifications to the appliance are not permitted.
- Do not place or store flammable liquids, highly inflammable materials or fusible objects (e.g. plastic film, plastic, aluminium) on or near the appliance.

Children's safety

- Small children must be kept away from the appliance.
- Only let bigger children work on the appliance under supervision.
- To avoid small children and pets unintentionally switching the appliance on, we recommend activation of the child safety device.

General safety

- The appliance may only be installed and connected by trained, registered service engineers.
- Built-in appliances may only be used after they have built in to suitable built-in units and work surfaces that meet standards.
- In the event of faults with the appliance or damage to the glass ceramic (cracks, scratches or splits), the appliance must be switched off and disconnected from the electrical supply, to prevent the possibility of an electric shock.
- Repairs to the appliance must only be carried out by trained registered service engineers.

Safety during use

- Overheated fats and oils can ignite very quickly. Warning! Fire hazard!
- There is the risk of burns from the appliance if used carelessly.
- Remove stickers and film from the glass ceramic.
- Cables from electrical appliances must not touch the hot surface of the appliance or hot cookware.
- Switch the cooking zones off after each use.

Safety when cleaning

- For cleaning, the appliance must be switched off and cooled down.
- For safety reasons, the cleaning of the appliance with steam jet or high-pressure cleaning equipment is not permitted.

How to avoid damage to the appliance

- The glass ceramic can be damaged by objects falling onto it.
- The edge of the glass ceramic can be damaged by being knocked by the cookware.
- Cookware made of cast iron, cast aluminium or with damaged bottoms can scratch the glass ceramic if pushed across the surface.

- Objects that melt and things that boil over can burn onto the glass ceramic and should be removed straightaway.
- To avoid damaging cookware and glass ceramics, do not allow saucepans or frying pans to boil dry.
- Do not use the cooking zones with empty cookware or without cookware.

Description of the Appliance

Cooking surface layout

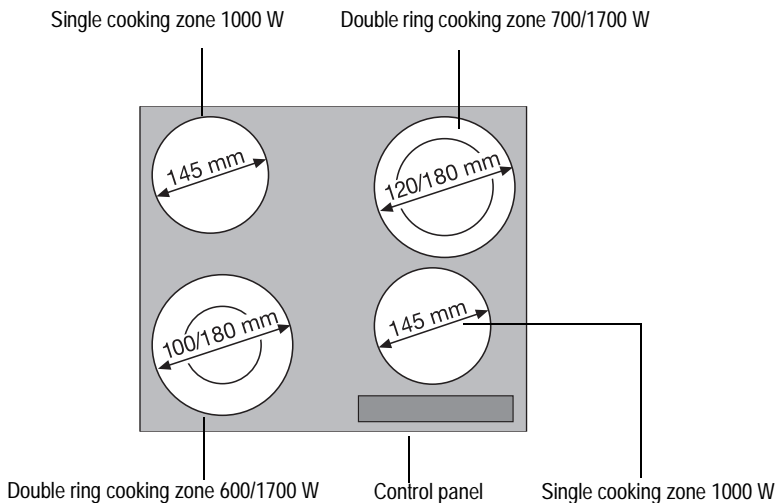

Control panel layout

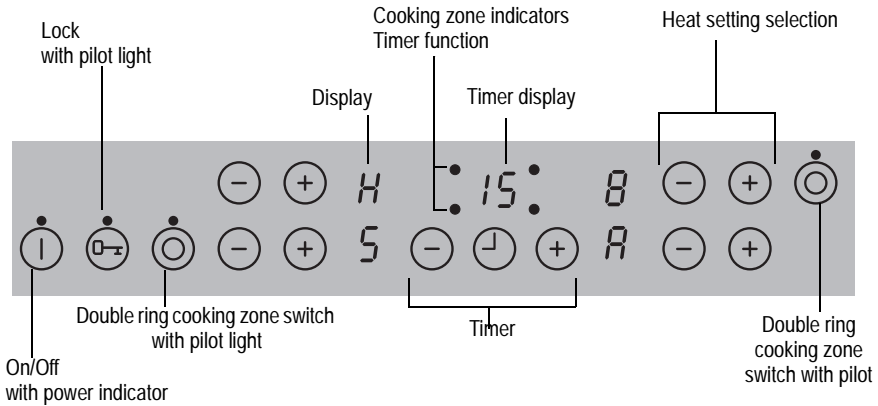









Touch Control sensor fields



The appliance is operated using Touch Control sensor fields. Functions are controlled by touching sensor fields and confirmed by displays and acoustic signals. Touch the sensor fields from above, without covering other sensor fields.

| Sensor field | Function | |
|--------------|--------------------|-------------------------------------|
| ⏻ | On / Off | To switch the appliance on and off |
| + | Increase settings | Increasing heat setting/time |
| - | Decrease settings | Decreasing heat setting/time |
| 🕒 | Timer | Timer selection |
| 🔒 | Lock | Locking/unlocking the control panel |
| 🔥 | Double ring switch | Switches outside ring on and off |

Displays

| Display | Description | |
|---|------------------------------|---|
|  | Cooking zone is switched off | |
|  | Keep warm setting | Keep warm setting is set |
|  | Heat settings | Heat setting is set |
|  | Automatic warm up function | Automatic warm-up function is activated |
|  | Fault | Malfunction has occurred |
|  | Residual heat | Cooking zone is still hot |
|  | Child safety device | Lock/child safety device is engaged |
|  | Automatic switch off | Switch off is active. |

Residual heat indicator

 **Warning!** Risk of burns from residual heat. After being switched off, the cooking zones need some time to cool down. Look at the residual heat indicator .

 Residual heat can be used for melting and keeping food warm.

Operating the appliance

Switching the appliance on and off

| | Control panel | Display | Pilot light |
|------------|------------------------------|---------------------|-------------|
| Switch on | Touch ⓪ for 2 seconds | ⓪ / H | lights up |
| Switch off | Touch ⓪ for 1 second | H / none | goes out |

- i** After switching on, within approx. 10 seconds a heat setting or a function must be set, otherwise the appliance automatically switches itself off.

Setting the heat setting

| | Control panel | Indicator |
|---------------|--|----------------------|
| To increase | Touch + | ⓪ to 9 |
| To decrease | Touch - | 9 to ⓪ |
| To switch off | Touch + and - at the same time | ⓪ |

- i** The keep warm setting **⓪** lies between **⓪** and **⓪**. It is used to keep food warm.

Switching the outside ring on and off



By switching the outside rings on or off, the effective heating surface can be matched to the size of the cookware.

- i** Before an outside ring can be switched on, the inside ring must be switched on.

| Double ring cooking zones | Sensor field | Pilot light |
|----------------------------|--------------------------------|-------------|
| To switch on outside ring | Touch ⓪ for 1-2 seconds | is lit |
| To switch off outside ring | Touch ⓪ for 1-2 seconds | goes out |

Locking/unlocking the control panel

The control panel, with the exception of the "On/Off" sensor field, can be locked at any time in order to prevent the settings being changed e.g. by wiping over the panel with a cloth.

| | Control panel | Display |
|------------|---|---|
| Switch on | Touch  |  (for 5 seconds) |
| Switch off | Touch  | previously set heat setting |

 When you switch the appliance off, the locking function is automatically switched off.

Using the automatic warm-up function

All cooking zones are equipped with an automatic warm up function. When setting a heat

setting using \oplus , when starting from $\boxed{0}$, the cooking zone switches to full power for a certain amount of time and then automatically switches back to the heat setting set.

| | Control panel | possible heat settings | Display |
|--|-----------------|--|-------------------------------|
| Switch on (only when starting at $\boxed{0}$) | Touch \oplus | $\boxed{1}$ to $\boxed{8}$ | \boxed{A} (after 5 seconds) |
| Switch off | Touch \ominus | $\boxed{8}$ to $\boxed{1}$ / $\boxed{0}$ | \boxed{B} to $\boxed{0}$ |
| Not used | Touch \ominus | $\boxed{9}$ to $\boxed{0}$ | $\boxed{9}$ to $\boxed{0}$ |

- i** If during the automatic warm up \boxed{A} a higher heat setting is selected, e.g. from $\boxed{3}$ to $\boxed{5}$, the automatic warm up is adjusted.
- i** If there is still residual heat on the cooking zone (display \boxed{H}), the automatic warm up is not performed.
- i** If the power of a cooking zone is reduced by the Power Management, the automatic warm up for this cooking zone is ended.



The length of time that the automatic warm up function operates depends on the heat setting selected.

| Heat setting | Length of the automatic warm up [min:sec] |
|--------------|---|
| $\boxed{0}$ | 0:30 |
| $\boxed{1}$ | 1:00 |
| $\boxed{2}$ | 1:40 |
| $\boxed{3}$ | 4:50 |
| $\boxed{4}$ | 6:30 |
| $\boxed{5}$ | 10:10 |
| $\boxed{6}$ | 2:00 |
| $\boxed{7}$ | 3:30 |
| $\boxed{8}$ | 4:30 |
| $\boxed{9}$ | --- |



Using the child safety device

The child safety device prevents unintentional use of the appliance.

Switching on the child safety device



| Step | Control panel | Display/Signal |
|---|---|---|
| 1. | ① Switch on appliance. (Do not set a heat setting.) |  |
| 2. | Touch  for 4 seconds |  |
| The child safety device is switched on. | | |

Switching off the child safety device

| Step | Control panel | Display/Signal |
|--|---|---|
| 1. | ① Switch on appliance. (Do not set a heat setting.) |  |
| 2. | Touch  for 4 seconds |  lights up |
| 3. | ① Switch appliance off. | |
| The child safety device is switched off. | | |

Overriding the child safety device

The child safety device can be switched off in this way for a single cooking session; it remains activated afterwards.

| Step | Control panel | Display/Signal |
|---|---|---|
| 1. | ① Switch appliance on |  |
| 2. | Touch  for 4 seconds |  lights up |
| Until the appliance is next switched off, it can be used as normal. After switching off the appliance, the child safety device is active again. | | |

 After overriding the child safety device, a heat setting or a function must be set within approx. 10 seconds, otherwise the appliance automatically switches itself off.

Power Management

The appliance has a maximum power output. If this maximum power is exceeded, the Power Management automatically reduces the power of the last cooking zone to be switched on.

This can happen by:

- switching on another cooking zone
- switching on an outer ring, when other cooking zones are already switched on at high settings
- increasing the heat setting on a cooking zone, when other cooking zones are already switched on at high settings

The display for the last cooking zone to be switched on alternates for 1 minute between the heat setting set and the maximum possible heat setting. During this period it is not possible to increase the heat setting. Thereafter the actual heat setting is displayed.









Example: heat setting 9 is selected on a cooking zone. Heat setting 9 is also set for another cooking zone. If this exceeds the maximum output, the Power Management reduces the power of the last cooking zone to be switched from 9 to 7, for example, and the display for this cooking zone alternates between 9 and 7 and then remains on the current maximum of 7. (Whether the display alternates between 9 and 7 or 9 and 6 or other values, depends on the appliance type and the size of the cooking zone.)

Using the timer

| Function | Condition | Outcome after the time has elapsed |
|--------------------------|--------------------------|--|
| Automatic cut-out | a heat setting is set | acoustic signal 00 flashes Cooking zone switches off |
| Countdown timer | cooking zones not in use | acoustic signal 00 flashes |



- i** If a heat setting is set on this cooking zone in addition to a countdown timer, the cooking zone is switched off after the time set has elapsed.
- i** If a cooking zone is switched off, the timer function set is also switched off.

Selecting a cooking zone

| Step | Control panel | Display |
|------|--|--|
| 1. | Touch  once | Pilot light of the first cooking zone flashes  |
| 2. | Touch  once | Pilot light of the second cooking zone flashes  |
| 3. | Touch  once | Pilot light of the third cooking zone flashes  |
| 4. | Touch  once | Pilot light of the fourth cooking zone flashes  |



- i** If the pilot light is flashing more slowly, the heat setting can be set or modified.
- i** If other timer functions are set, after a few seconds the shortest remaining time of all the timer functions is displayed and the corresponding pilot light flashes.

Setting the time

| Step | Control panel | Indicator |
|------|--|---|
| 1. | Select  cooking zone | Pilot light for the cooking zone selected flashes |
| 2. | Touch  or  | 00 to 99 minutes |



After a few seconds the pilot light flashes more slowly.
The time is set.
The time counts down.

Switching off the timer function

| Step | Control panel | Indicator |
|------|---|--|
| 1. | Select  cooking zone | Pilot light of cooking zone selected flashes faster Time remaining is displayed |
| 2. | Touch  | The time remaining counts backwards to 00 . |

The pilot light goes out.
The Timer function for the selected cooking zone is switched off.

Changing the time

| Step | Control panel | Indicator |
|------|--|--|
| 1. | Select  cooking zone | Pilot light of the selected cooking zone flashes faster Time remaining is displayed |
| 2. | Touch  or  | 0 1 to 99 minutes |

After a few seconds, the pilot light flashes more slowly.
The time is set.
The time counts down.

Displaying the time remaining for a cooking zone

| Step | Control panel field | Display |
|------|---|--|
| 1. |  Select cooking zone | Pilot light of the cooking zone selected flashes faster The time remaining is displayed |

After a few seconds the pilot light flashes more slowly.

Switching off the acoustic signal



| Step | Control panel field | Acoustic signal |
|------------------------|---|---------------------------------|
| 1. | Touch  | Acoustic signal to acknowledge. |
| Acoustic signal stops. | | |

Automatic switch off

Cooking surface

- If after switching on the cooking surface, a heat setting is not set for a cooking zone within approx. 10 seconds, the cooking surface automatically switches itself off.
- If one or more sensor fields are covered by objects (a pan, cloths, etc.) for longer than approx. 10 seconds, a signal sounds and the cooking surface switches off automatically.
- If all cooking zones are switched off, the cooking surface automatically switches itself off after approx. 10 seconds.

Cooking zones

- If one of the cooking zones is not switched off after a certain time, or if the heat setting is not modified, the relevant cooking zone switches off automatically.  is displayed. Before being used again, the cooking zone must be set to .

| Heat setting | Switches off after |
|--------------|--------------------|
| 1 - 2 | 6 hours |
| 3 - 4 | 5 hours |
| 5 | 4 hours |
| 6 - 9 | 1.5 hours |

Tips on Cooking and Frying

i Information on acrylamides

According to the latest scientific knowledge, intensive browning of food, especially in products containing starch, can constitute a health risk due to acrylamides. Therefore we recommend cooking at the lowest possible temperatures and not browning foods too much.

Cookware

- You can recognise good cookware from the bottoms of the pans. The bottom should be as thick and flat as possible.
- Cookware made of enamelled steel or with aluminium or copper bottoms can leave discolorations on the glass ceramic surface which are difficult or impossible to remove.

Energy saving

- ♣** Always place cookware on the cooking zone before it is switched on.

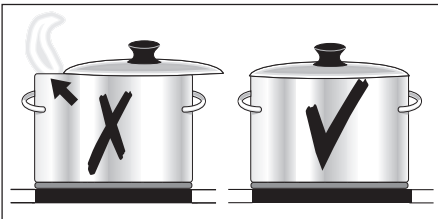

- ♣** If possible, always place lids on the pans.

- ♣** Switch cooking zones off before the end of the cooking time, to take advantage of residual heat.

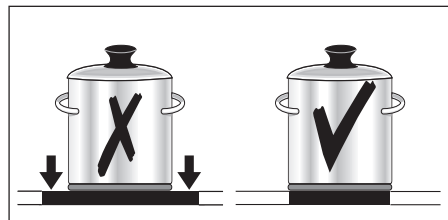



- ♣** Bottom of pans and cooking zones should be the same size.

Examples of cooking applications

The information given in the following table is for guidance only.

| Heat setting | Cooking-process | suitable for | Cooking time | Tips/Hints |
|--------------|------------------------------------|---|--------------------|--|
| 0 | | Residual heat, Off position | | |
| 1 | Keeping food warm | Keeping cooked foods warm | as required | Cover |
| 1-2 | Melting | Hollandaise sauce, melting butter, chocolate, gelatine | 5-25 mins. | Stir occasionally |
| | Solidifying | Fluffy omelettes, baked eggs | 10-40 mins. | Cook with lid on |
| 2-3 | Simmering on low heat | Simmering rice and milk-based dishes Heating up ready-cooked meals | 25-50 mins. | Add at least twice as much liquid as rice, stir milk dishes part way through cooking |
| 3-4 | Steaming Braising | Steaming vegetables, fish braising meat | 20-45 mins. | With vegetables add only a little liquid (a few tablespoons) |
| 4-5 | Boiling | Steaming potatoes | 20-60 mins. | Use only a little liquid, e. g.: max. $\frac{1}{4}$ l water for 750 g potatoes |
| | | Cooking larger quantities of food, stews and soups | 60-150 mins. | Up to 3 l liquid plus ingredients |
| 6-7 | Gentle Frying | Frying escalopes, veal cordon bleu, cutlets, rissoles, sausages, liver, roux, eggs, pancakes, doughnuts | Steady frying | Turn halfway through cooking |
| 7-8 | Heavy Frying | Hash browns, loin steaks, steaks, Flädle (pancakes for garnishing soup) | 5-15 mins. per pan | Turn halfway through cooking |
| 9 | Boiling Searing Deep frying | Boiling large quantities of water, cooking pasta, searing meat (goulash, pot roast), deep frying chips | | |

Cleaning and Care

-  **Take care!** Risk of burns from residual heat.
-  **Warning!** Sharp objects and abrasive cleaning materials will damage the appliance. Clean with water and washing up liquid.
-  **Warning!** Residues from cleaning agents will damage the appliance. Remove residues with water and washing up liquid.

Cleaning the appliance after each use



1. Wipe the appliance with a damp cloth and a little washing up liquid.
2. Rub the appliance dry using a clean cloth.

Removing deposits

1. Place a scraper on the glass ceramic surface at an angle.
2. Remove residues by sliding the blade over the surface.
3. Wipe the appliance with a damp cloth and a little washing up liquid.
4. Rub the appliance dry using a clean cloth.



| Type of dirt | Remove | | |
|-------------------------------|-------------|------------------------------------|---|
| | immediately | when the appliance has cooled down | using |
| sugar, food containing sugar | yes | --- | a scraper* |
| plastics, tin foil | yes | --- | |
| limescale and water rings | --- | yes | cleaner for glass ceramic or stainless steel* |
| fat splashes | --- | yes | |
| shiny metallic discolouration | --- | yes | |

* Scrapers and cleaners for glass ceramic and stainless steel can be purchased in specialized shops

-  Remove stubborn residues with a cleaner for glass ceramic or stainless steel.
-  Scratches or dark stains on the glass ceramic that cannot be removed do not however affect the functioning of the appliance.

What to do if ...

| Problem | Possible cause | Remedy |
|--|--|---|
| The cooking zones will not switch on or are not functioning | More than 10 seconds have passed since the appliance was switched on | Switch the appliance on again. |
| | The child safety device is switched on (L) | Deactivate the child safety device (See the section "Child safety device") |
| | Several sensor fields were touched at the same time | Only touch one sensor field |
| | Automatic switch off has been triggered | Remove any objects (pan, cloths, etc.) that are lying on the control panel. Switch the appliance on again |
| | The lock is switched on (L) | Switch off the lock (See the section "Locking/unlocking the control panel") |
| Acoustic signal sounds when appliance is switched off | The control panel is wholly or partly covered by objects. | Remove objects. |
| The residual heat indicator is not displaying anything | The cooking zone was only on for a short time and is therefore not hot | If the cooking zone is supposed to be hot, call the Customer Service Department. |
| The automatic warm up function is not switching itself on | There is still residual heat on the cooking zone (H) | Let the cooking zone cool down |
| | The highest heat setting is set (9) | The highest heat setting has the same power as the automatic warm up function |
| | The heat setting was set using the sensor field (⊖) | <ol style="list-style-type: none"> Switching off the cooking zone Set the cooking zone using the sensor field (⊕) |
| Acoustic signal sounds and appliance switches itself on and then off again; after 5 seconds another acoustic signal sounds | The On/Off sensor field has been covered up, e.g. by a cloth | Do not place any objects on the control panel |
| (-) is lit | Overheating protection for the cooking zone has been triggered | Switch off the cooking zone. Switch the cooking zone on again |
| | Automatic switch off has been triggered | Switch off the cooking zone. Switch the cooking zone on again |

| Problem | Possible cause | Remedy |
|--|-------------------|---|
|  and number are displayed | Electronics fault | Disconnect the appliance from the electrical supply for a few minutes (Take the fuse out of the house's wiring system) If after switching on again,  is displayed again, call the customer service department |

If you are unable to remedy the problem by following the above suggestions, please contact your local Service Force Centre.

 **Warning!** Repairs to the appliance are only to be carried out by qualified service engineers. Considerable danger to the user may result from improper repairs.

 If the appliance has been operated incorrectly, the engineer's visit will be chargeable, even during the warranty period.

Disposal

Packaging material

The packaging materials are environmentally friendly and can be recycled. The plastic components are identified by markings, e.g. >PE<, >PS<, etc. Please dispose of the packaging materials in the appropriate container at the community waste disposal facilities.

Old appliance

The symbol  on the product or on its packaging indicates that this product may not be treated as household waste. Instead it shall be handed over to the applicable collection point for the recycling of electrical and electronic equipment. By ensuring this product is disposed of correctly, you will help prevent potential negative consequences for the environment and human health, which could otherwise be caused by inappropriate waste handling of this product. For more detailed information about recycling of this product, please contact your local city office, your household waste disposal service or the shop where you purchased the product.

Installation Instructions

Safety instructions

Warning! This must be read!

The laws, ordinances, directives and standards in force in the country of use are to be followed (safety regulations, proper recycling in accordance with the regulations, etc.)

Installation may only be carried out by a qualified electrician.

The minimum distances to other appliances and units are to be observed.

Anti-shock protection must be provided by the installation, for example drawers may only be installed with a protective floor directly underneath the appliance.

The cut surfaces of the worktop are to be protected against moisture using a suitable sealant.

The sealant seals the appliance to the work top with no gap.

Avoid installing the appliance next to doors and under windows. Otherwise hot cookware may be knocked off the rings when doors and windows are opened.

Risk of injury from electrical current.

- The electrical mains terminal is live.
- Make electrical mains terminal free of voltage.
- Follow connection schematic.
- Observe electrical safety rules.
- Ensure anti-shock protection by installing correctly.
- The appliance must be connected to the electrical supply by a qualified electrician.

Risk of injury from electrical current.

- Loose and inappropriate plug and socket connections can make the terminal overheat.
- Have the clamping connections correctly installed by a qualified electrician.
- Use strain relief clamp on cable.
- In the event of single-phase or two-phase connection, the appropriate mains cable of type H05BB-F Tmax 90°C (or higher) or an equivalent type must be used.
- If this appliance's mains cable is damaged, it must be replaced by a special cable (type H05BB-F Tmax 90°C; or higher) or an equivalent type. The latter is available from the Customer Care Department.

A device must be provided in the electrical installation which allows the appliance to be disconnected from the mains at all poles with a contact opening width of at least 3 mm.

Suitable isolation devices include line protecting cut-outs, fuses (screw type fuses are to be removed from the holder), earth leakage trips and contactors.

Sticking on the seal

- Clean the worktop around the cut-out area.
- Stick the single-sided adhesive sealing tape provided on the underside of the hob around the outside edge ensuring that it is not stretched. The two ends of the tape should join in the middle of one side. After trimming the tape (allow it to overlap by 2-3 mm), press the two ends together.

Assembly

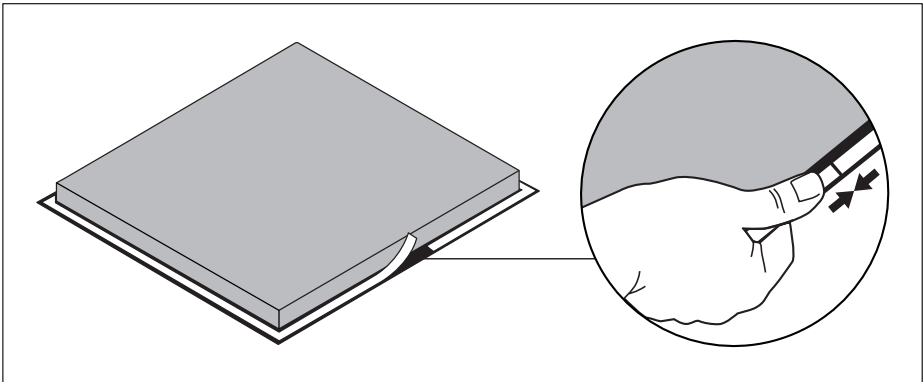
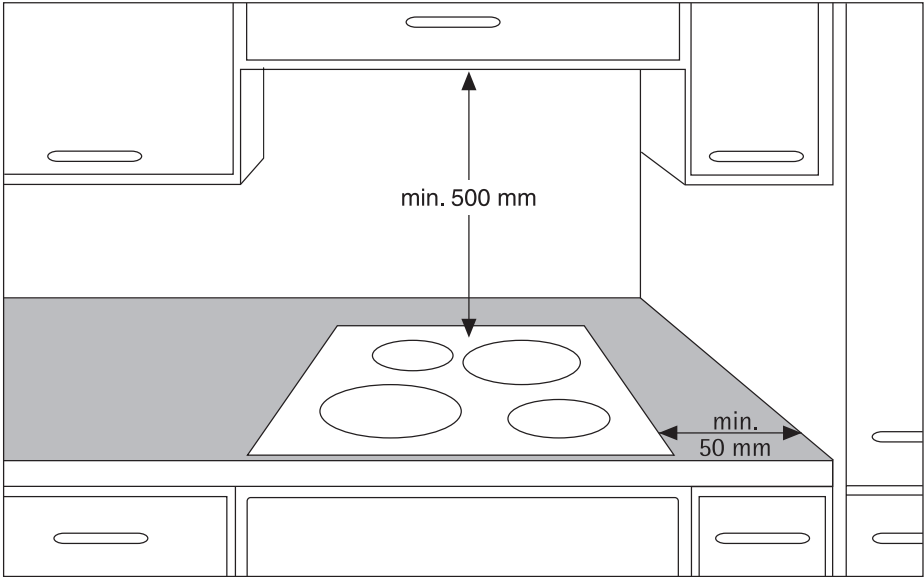

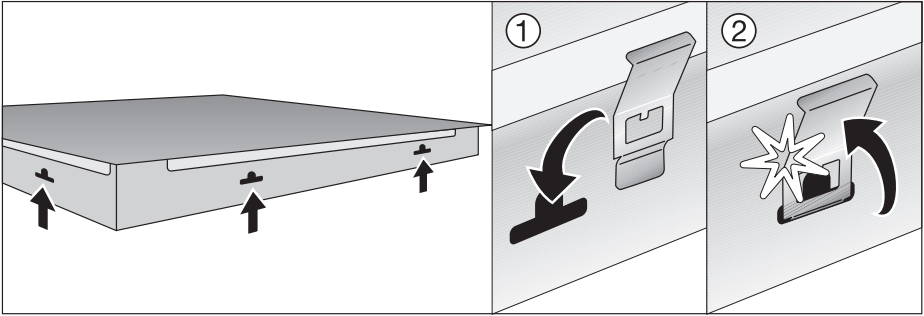

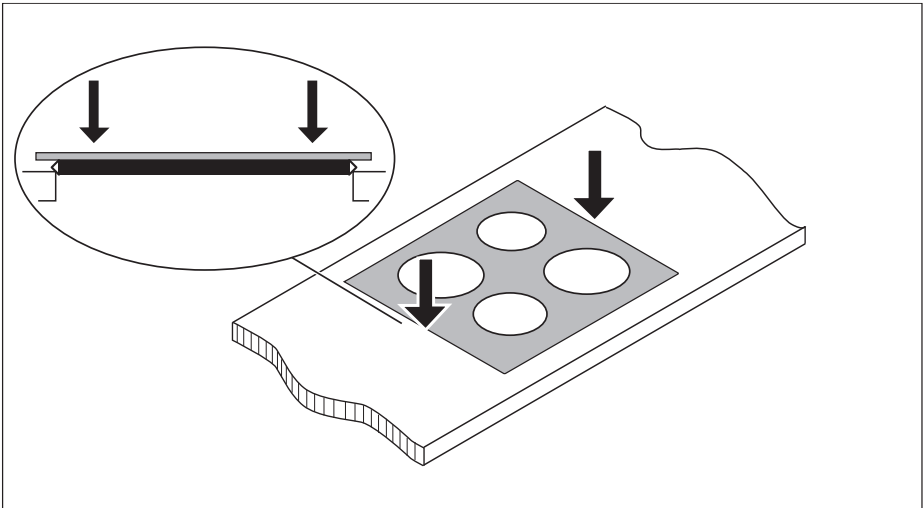
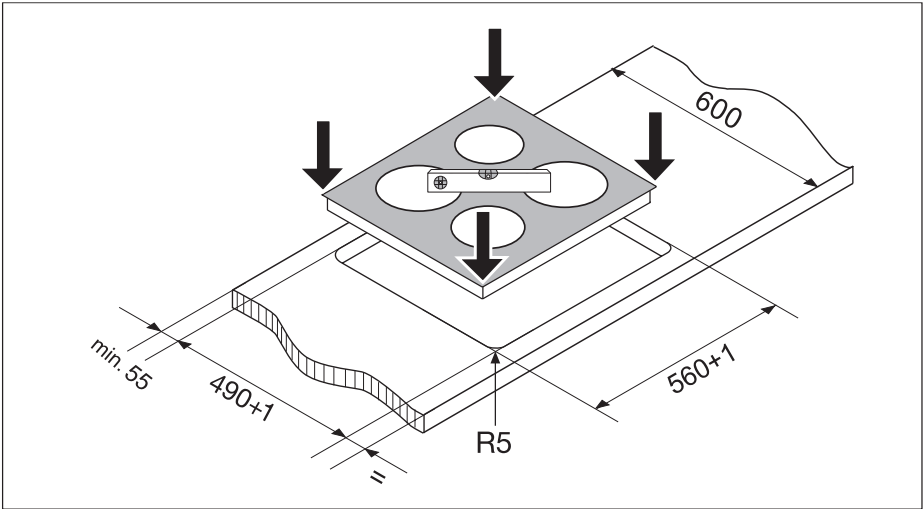

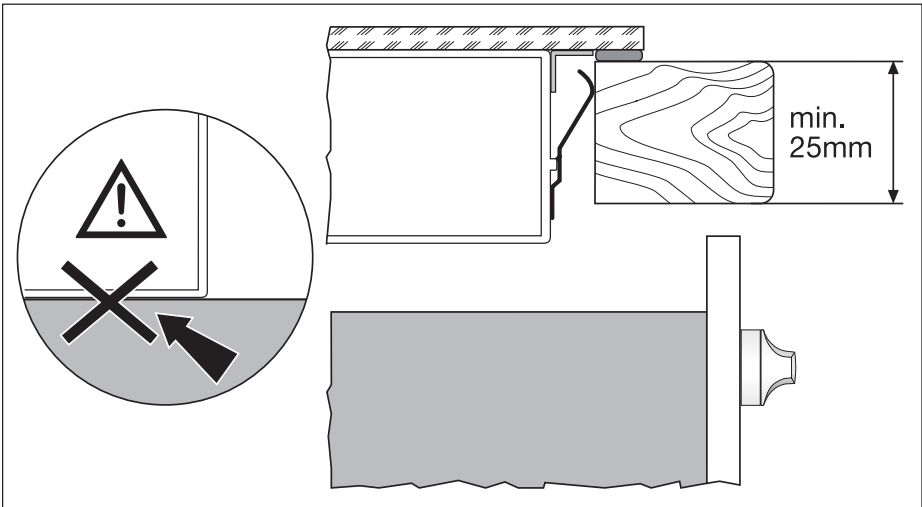
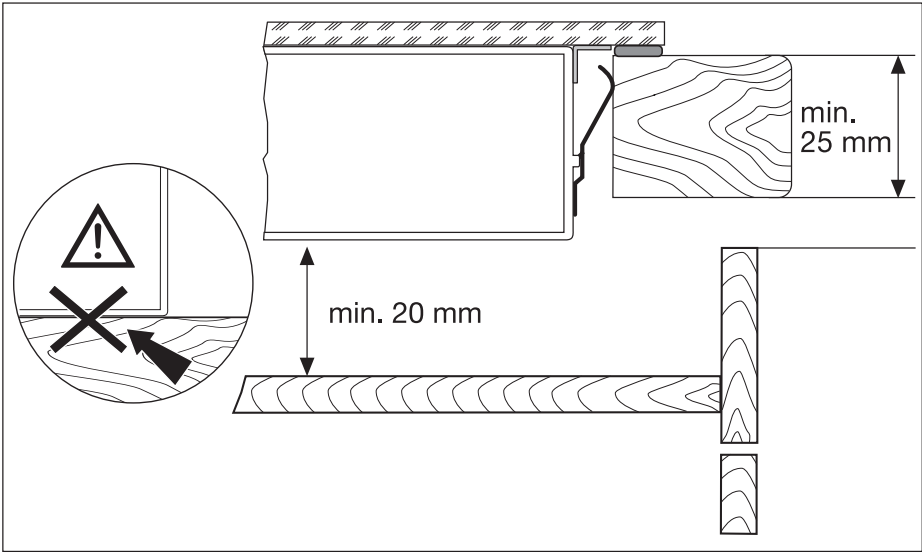





Rating Plate

| | | | |
|-----------------|--------------|---|---|
| Modell ZVH 66 F | | Prod.Nr. 949 593 078 | |
| Typ 55HAD64AO | 230 V | 50 Hz | |
| Made in Germany | Ser.Nr. | 2,4 kW |  |
| ZANUSSI | |   |  |



Service

In the event of technical faults, please first check whether you can remedy the problem yourself with the help of the operating instructions (section "What to do if...").

If you were not able to remedy the problem yourself, please contact the Customer Care Department or one of our service partners.

In order to be able to assist you quickly, we require the following information:

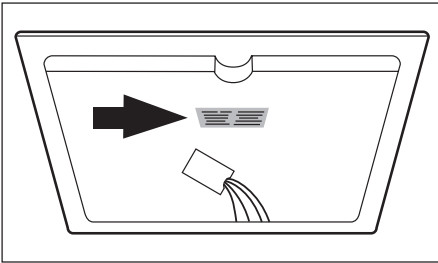

- Model description
- Product number (PNC)
- Serial number (S No.)
(for numbers see rating plate)
- Type of fault
- Any error messages displayed by the appliance
- three digit letter-number combination for glass ceramic

So that you have the necessary reference numbers from your appliance at hand, we recommend that you write them in here:

Model description:

PNC:

S No:

www.electrolux.com

www.zanussi.com

www.zanussi.at

www.zanussi.be

Free Manuals Download Website

<http://myh66.com>

<http://usermanuals.us>

<http://www.somanuals.com>

<http://www.4manuals.cc>

<http://www.manual-lib.com>

<http://www.404manual.com>

<http://www.luxmanual.com>

<http://aubethermostatmanual.com>

Golf course search by state

<http://golfingnear.com>

Email search by domain

<http://emailbydomain.com>

Auto manuals search

<http://auto.somanuals.com>

TV manuals search

<http://tv.somanuals.com>