

INSTRUCTION BOOKLET

ZANUSSI

**DISHWASHER
ZWS 744**

CONTENTS

Warnings	page	3
Installation	page	4
Positioning, levelling, adjusting the worktop, installing and securing the machine under a kitchen unit .	page	4
Water supply connections, water outlet connection	page	5
The electrical connections	page	5
Use	page	6
Control panel	page	6
The water softener, filling with salt	page	7
Use of rinse aid, use of detergent	page	8
Loading the machine, use of the lower basket, use of the upper basket	page	9
Adjusting the height of the upper basket	page	10
Helpful hints	page	10
Washing programmes	page	11
Operating sequence	page	12
Maintenance and cleaning	page	13
Cleaning the central filters, cleaning the large filter, internal and external cleaning	page	13
Servicing	page	14

TECHNICAL SPECIFICATIONS

DIMENSIONS	Width	cm 45
	Height with worktop	cm 85
	Height without worktop	cm 82
	Max depth	cm 61
	Max depth with door open	cm 120

ELECTRICAL CONNECTION	Voltage	220 - 230 V/50Hz
MOTOR RATING DURING WASHING		200 W
POWER OF HEATING ELEMENT		2800 W
OVERALL POWER		3000 W

WATER SUPPLY PRESSURE	minimum	5 N/cm ²
	maximum	80 N/cm ²

CAPACITY (STANDARD IEC PLACE SETTINGS)		9
--	--	---

CONSUMPTION:	Water	18 lt
	Electricity	1.2 kW/h

CE This appliance complies with the following E.E.C. Directives:
- 73/23 of 19.2.73 (Low Voltage Directive) and subsequent modifications;
- 89/336 of 3.5.89 (Electromagnetic Compatibility Directive) and subsequent modifications.

WARNINGS

It is most important that this instruction book should be retained with the appliance for future reference. Should the appliance be sold or transferred to another owner, or should you move house and leave the appliance, always ensure that the book is left with the appliance in order that the new owner can get to know the functioning of the appliance and the relevant warnings.

These warnings are provided in the interest of safety. You MUST read them carefully before installing or using the appliance.

- If the appliance is supplied with obvious damage, consult the supplier before installing it.
- Any plumbing work required to install this appliance should be carried out by a qualified plumber or competent person.
- Any electrical work required to install this appliance should be carried out by a qualified electrician or competent person.
- This appliance is designed to be operated by adults.
- Care must be taken to ensure that the appliance does not stand on the electrical supply cable or on the water inlet and drain hoses.
- These dishwashers are designed to be used for washing normal household utensils. Items that are contaminated by petrol, paint, steel or iron debris, corrosive, acidic or alkaline chemicals are not to be washed in a dishwasher.
- Under no circumstances should you open the door whilst the appliance is in operation. Always turn off the appliance before opening the door.
However, the dishwasher features a special safety device which cuts off the water inlet, should the door be accidentally opened, thus avoiding water leaks.
- Never touch the heating element during or immediately after the end of the washing cycle.
- When finishing loading or unloading close the door, as an open door can be a hazard.
- It is dangerous to lean or to sit on the dishwasher door: the appliance could tip over.
- Built-in dishwashers only: the appliance must be secured to the underside of the worktop using the brackets provided. Failure to do this could result in an unstable appliance which may cause damage or injury.
- Unplug the appliance and turn off the water after use.
- Under no circumstances should you attempt to repair the machine yourself. Repairs carried out by inexperienced persons may cause injury or serious malfunctioning.
- This appliance should be serviced only by an authorised Service Centre.
- Before disposing of the appliance, disconnect the water hose, cut the electrical cable and ensure that the door cannot close.
- For proper disposal of the appliance, contact your local waste collection service.

INSTALLATION

Remove all packaging before positioning the machine.

Positioning

If possible, position the machine next to a water tap and a drain.

The sides and the back of the dishwasher can rest against the adjacent furniture or the wall.

The dishwasher features fill and drain hoses which can be turned either to the left or the right to suit the installation.

Levelling

Good levelling is essential for correct closure and sealing of the door.

If the door does not close correctly, loosen or tighten the adjustable support feet, until the machine is perfectly level.

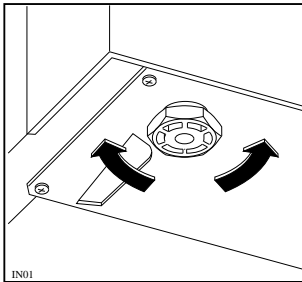

Adjusting the Worktop

You can move the worktop forward or backward by 25 mm in order to align the machine with other kitchen units.

Simply unscrew the two front retaining screws, move the top to the required position and then retighten the screws.

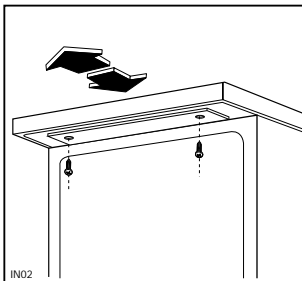

Installing and Securing the Machine Under a Kitchen Unit (Sink-Worktop Unit)

By removing the machine's worktop, you can install it under a close fitting sink unit or a pre-existing top, if the dimensions of the recess correspond to those shown in the picture.

Then proceed as follows:

Remove the machine worktop by unscrewing the two front retaining screws, pull from the front and slide out the rear slots, lifting the worktop.

Insert the machine after adjusting the height and levelling with the adjustable feet. When inserting the machine, ensure that the water inlet and drain hoses are not kinked or squashed.

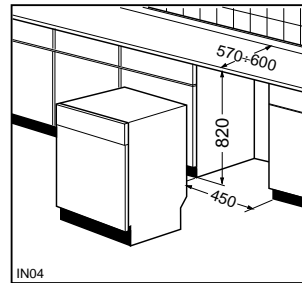

Caution

Once the machine has been installed, ensure that it can be accessed easily for servicing.

Water Outlet Connection

The end of the drain hose can be connected as follows:

to the sink outlet siphon, securing it if necessary with a clip;

to a wall outlet provided with vent-hole, minimum internal diameter 4 cm;

hooked over the edge of the sink using the special curved plastic guide provided.

The waste connection must be at a height of between 30 cm (minimum) and 100 cm (maximum) from the floor.

It makes no difference which way the drain hose faces, either to the right or left of the dishwasher.

Avoid bending or kinking the hose as this could prevent or slow down the discharge of water.

If you use a drain hose extension it must be no longer than 2 metres and its internal diameter must be no smaller than the diameter of the hose provided.

Likewise the internal diameter of the couplings used for connection to the waste outlet must be no smaller than the diameter of the drain hose.

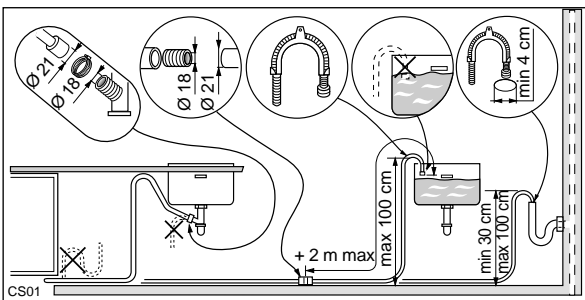

Water Supply Connections

This dishwasher may be fed with either hot (max. 60°C) or cold water.

Nevertheless we advise you a cold water supply. A hot water supply is not always efficient with very soiled crockery as it shortens the washing programmes a lot.

Feeding the appliance with a hot water supply (max. 60°C) will allow you to obtain considerably shorter programmes.

For making the connection itself, the coupling nut fitted to the machine's supply hose is designed to screw onto either a 3/4 inch gas thread spout, or to a purpose-made quick-coupling tap such as the Press-Block.

The water pressure must be within the limits given in the technical specifications, as it will not function correctly if pressure is outside these specifications.

The water supply hose is fitted with a safety device, which prevents water from entering the machine should the inner hose split, due to wear.

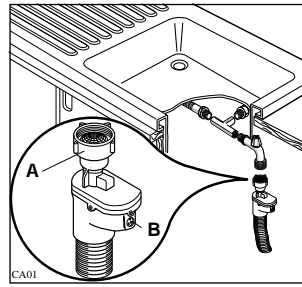

The problem is signalled by a red indicator which appears in window (B). If this happens, close the water tap and have the hose replaced.

Warning: the retaining ring (A) must be properly fitted so as to avoid water leaks.

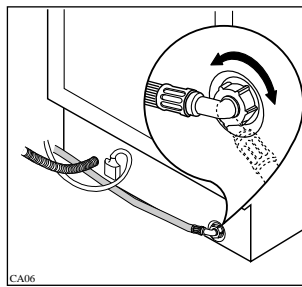

Note: the end of the hose connected to the machine can be positioned as required, by simply slackening the retaining ring.

Re-tighten the ring securely to avoid water leaks.

Avoid bends or kinks in the hose, which could prevent or slow down the flow of water.

If the machine is connected to new pipes or pipes which have not been used for a long time, you are advised to run the water for a few minutes before connecting the inlet hose. This will prevent deposits of sand or rust clogging the inlet hose filter.

Electrical connection

Before plugging the appliance into the wall socket, make sure that:

1. the mains voltage corresponds to the voltage given in the technical specifications;
2. the meter, fuses, mains power supply and wall socket can all take the maximum load required. Make sure that the socket and plug are compatible without having to use any type of adapter. If necessary, have the domestic wiring system socket replaced.

Safety standards require the appliance to be earthed.

The Manufacturer accepts no liability for failure to observe the above safety precautions.

USE

Control panel

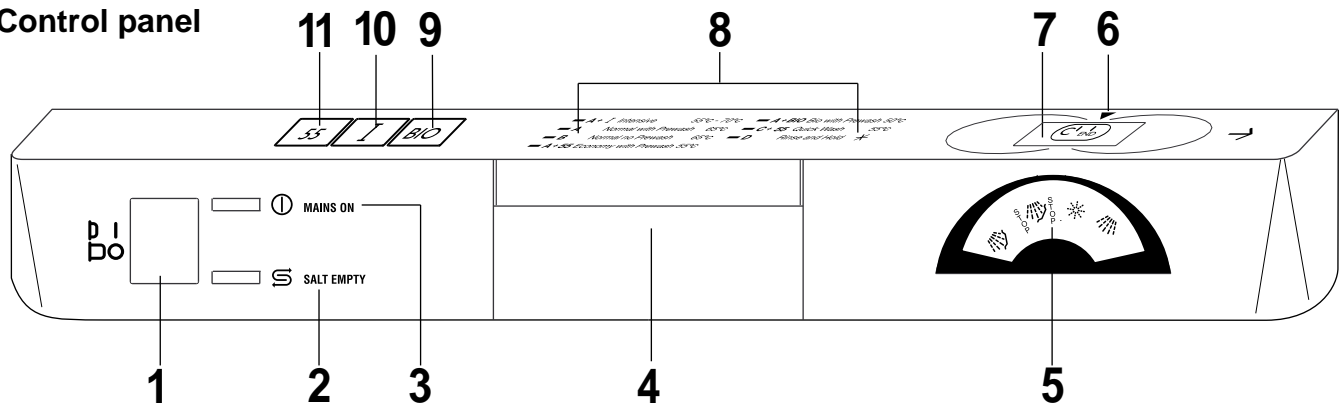

1. ON/OFF Pushbutton **p i Do**

ON

By depressing this pushbutton the machine starts operating and, at the same time, the pilot light comes on.

OFF

When the washing programme has finished, the machine stops automatically and the pilot light (2) remains on. To switch the pilot light off or to stop the machine at any time, press the same button again.

2. Salt Empty Indicator Light **S**

This light will come on when the salt container needs refilling. This light will remain on in a soft water area where salt is not required.

3. Pilot Light ON/OFF **I**

This comes on when the ON/OFF button (1) is depressed, indicating that the machine is on.

4. Door Handle

To open the door press the catch in the top of the recess and pull the door toward you at the same time.

5. Wash Programme Phase Indicator

During the washing programme the Programme Selector Dial turns, indicating the phase being performed.

The symbols have the following meaning:

-  Prewash
-  Main wash
-  Cold rinse
-  Warm rinse
-  Hot air drying

6. Programme Marker ▼

7. Programme Selector Dial

To select a programme, turn the Programme Selector Dial clockwise, making sure that the programme letter you wish to select corresponds with the Programme Marker (6) on the control panel. When the programme has finished, the Programme Marker (6) will correspond with "END" or "STOP" on the Programme Selector Dial.

8. Programme Guide

This is a summary of the washing programme chart to help you to select the correct programme.

9. "BIO" Pushbutton

This button allows selection of special "Bio" programmes, suitable for compact and tablet detergents containing enzymes.

The Bio Programme and the new compact detergents offers you, at a temperature as low as 50°C, the same washing result of the stronger programmes at 65°C with the traditional detergents.

10. "Intensive" Pushbutton

This button allows selection of the most Intensive wash programme, suitable for very heavily soiled pots, pans and crockery.

11 Economic "55" Pushbutton

By depressing this pushbutton you will reduce the water temperature of the main wash from 65°C to 55°C. See also the indications on the washing programme chart.

The Water Softener

Water contains varying amounts of lime and mineral salts depending on the area in which you live: these are deposited on the dishes leaving white marks.

The higher the content of these salts, the harder your water will be. The «hardness» level is measured on 2 equivalent scales: German degrees or French degrees. Contact your local Water Authority to find the exact water hardness level for your area.

The dishwasher is equipped with a softener which uses special dishwasher salt to provide lime-free (softened) water. The softener can treat water hardness up to 90 French degrees via 5 adjustment levels.

Find on the table below the level corresponding to the hardness of your water and the required adjustments:

Water hardness		Level	Use of salt	Water softener adjustment	Adjustment on the machine
°dH German degrees	°TH French degrees				
0-7	0-14	1	**NO	NO	1
8-21	15-39	*2	YES	NO	1
22-28	40-50	3	YES	YES	1
29-39	51-70	4	YES	NO	2
40-50	71-90	5	YES	YES	2

* The water softener is factory set at level 2 as this suits most users.

** If you use phosphate free detergents containing enzymes, use salt starting from 4°dH (7°TH).

Level 1

If your water is «level 1» it is already soft and therefore there is no need to use salt.

Levels 3 and 5 (water softener adjustment)

If your water is level 3 or 5, proceed as follows:

slide out the lower basket and unscrew the cap of the salt container; turn the two-position selector anticlockwise from position - to position + with the aid of a knife or a screwdriver.

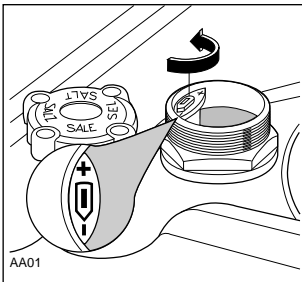

Levels 4 and 5 (adjustment on the machine)

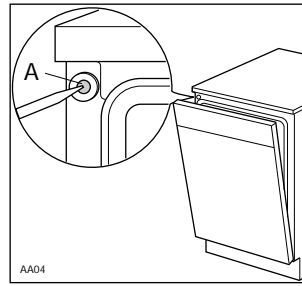

If your water is level 4 or 5, open the door and drill membrane (A) on the upper left-hand corner of the machine.

With a water hardness of level 5 both adjustments must be made.

Important

Salt MUST be used regularly from level 2 upward.

Filling with Salt

Only use salt designed specifically for use in dishwashers. Other types of salt contain high percentages of other substances which may reduce the efficiency of the softener.

Unscrew the cap of the salt container.

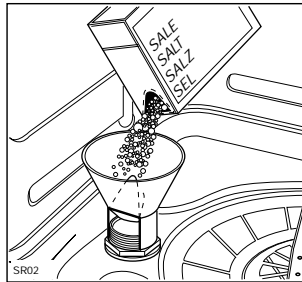

Fill the container with 1 litre of water (this operation is necessary only the first time).

Place approximately 1 kg of dishwasher salt inside using the funnel provided (see figure).

Replace the cap making sure that there is no trace of salt on the screw thread or on the gasket.

Screw the cap on tightly.

When this has been done, all that is required is to periodically add salt to the container. You are reminded of this by the salt indicator light  on the control panel which will normally illuminate when the salt has finished.

The salt container has always some water inside which will normally overflow when refilling with salt.

Important: the salt indicator light on the control panel can remain illuminated for 2-6 hours after salt has been replenished, assuming the dishwasher remains switched on. If you are using salts that take longer to dissolve, then the light remains illuminated for a long period of time. The functioning of the dishwasher is not affected.

Caution

Only fill with salt just before starting one of the complete washing programmes (not Rinse and Hold programme). This will prevent any grains of salt or salty water, which may have been spilled, remaining on the bottom of the machine for any period of time. This could cause corrosion.

Rinse Aid

The use of this liquid ensures thorough rinsing, spot and streak free drying, making the water run quickly off the dishes for sparkling results. It is automatically added during the hot rinse. The dispenser, which is positioned inside the door, holds about 110 ml of rinse aid, which is sufficient for 16-40 dishwashing programmes, depending upon the dosage setting.

Filling with Rinse Aid

Open the container by turning the lid (A) anticlockwise.

Add rinse aid until the container is completely full (approx. 110 ml). The indicator (B) will be completely dark.

Top up with rinse aid when the indicator (B) becomes clear (approx. 70 - 80 ml).

Remember to CLOSE the lid after every refill.

Caution

Clean up any rinse aid spilt during filling with an absorbent cloth to avoid excess foaming during the next wash.

Adjusting the Dose

According to the finish and drying results obtained, adjust the dose of rinse aid by means of the 6 position selector (C) (position 1 - minimum dose, position 6 maximum dose). (Start from position 3). Gradually increase the dose if there are drops of water or lime spots on the dishes after washing. Reduce it if there are sticky whitish streaks on the dishes.

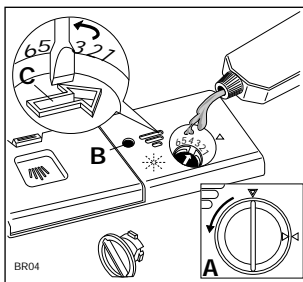

Caution: Do not put liquid detergent into the rinse aid compartment

Use of Detergent

Before starting any of the dishwashing programmes, except for the Rinse and Hold programme, load the detergent in the dispenser.

Use only tablets, powder or liquid detergents specifically designed for domestic dishwashers.

Unsuitable detergents (such as those for washing by hand) do not contain the right ingredients for machine washing and hamper correct functioning of the machine.

To open the dispenser lid, pull the catch (D).

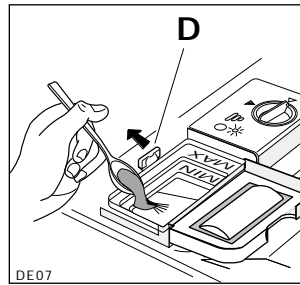

To help you to correctly dose the right amount of detergent, inside the container there are two reference marks:

- MIN = 15 ml
- MAX = 30 ml

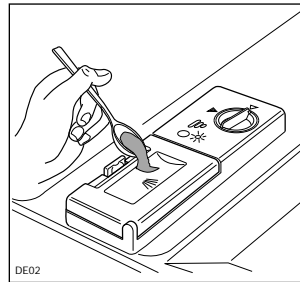

All the programmes with prewash required a small extra amount of detergent of approximately 5 g (10 g for the Intensive programme) to be poured over the dispenser's lid as shown in the picture.

The amount of detergent to be used varies depending on how soiled the dishes are and the type of dishes being washed. We recommend the amounts shown in the programme chart .

After filling the dispenser with detergent, close the lid.

At the end of any washing programme the lid is always open, ready for the next wash.

Since not all detergents are the same, you should also consult the instructions on the packet.

Remember that insufficient quantities of detergent will produce poor washing results whereas an excessive amount of detergent does not improve washing results and is also wasteful.

Using no more than the correct amount of detergent also contributes to reducing pollution.

Phosphate free detergents with enzymes

In these low-alkaline compact powders the environment unfriendly components have been replaced by natural enzymes and other more biodegradable substances. The enzymes deploy their full dirt dissolving power at a temperature as low as 50°C.

By choosing the Bio-programme you can therefore achieve the same cleaning results that would otherwise be achievable only with 65°C programmes and conventional detergents.

These new compact powders are generally phosphate-free. As phosphates have water softening properties, we suggest you add salt to the salt container even if the hardness of your water is as low as 4 °dh (7 °TH).

This will avoid lime deposits on crockery and the inner tub.

Loading your Machine

Before placing dishes in the machine, remove any scraps of food from the plates (small bones, toothpicks, fish bones, scraps of meat and vegetables, fruit skins etc.) to avoid clogging the filters and consequently reducing performance.

Open the door and slide out the baskets to load the dishes.

Use of the Lower Basket

The lower basket is designed to take saucepans, lids, plates (up to 27 cm in diameter), salad bowls, cutlery etc. Serving dishes and large lids should be arranged around the edge of the basket, ensuring that the upper spray arm can turn freely.

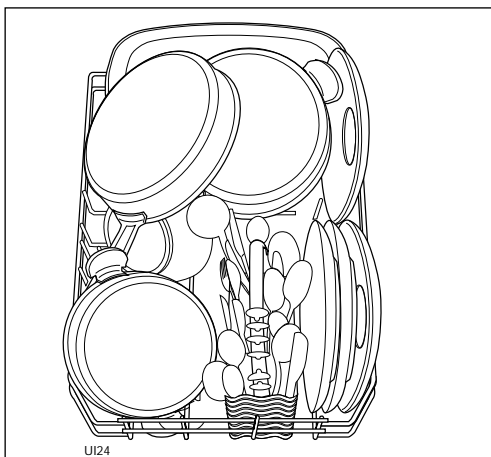
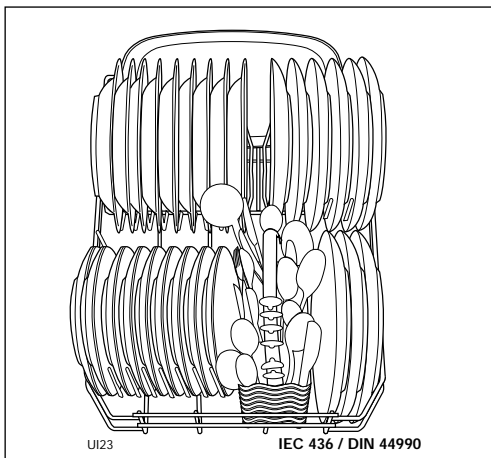

Cutlery should be placed in the removable cutlery basket with the handles facing downwards. If the handles protrude from the bottom of the basket, obstructing the lower spray arm, load the cutlery with the handles facing upward.

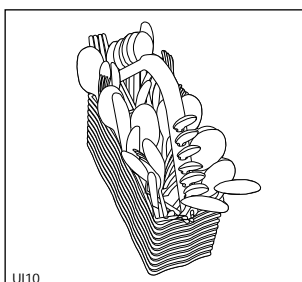

Mix spoons with the other cutlery to prevent them sticking together.

Teaspoons may be loaded into the special slots provided in the cutlery basket handle.

The two rear rows of prongs on the lower basket can be easily lowered to allow you to load pots, pans and bowls.

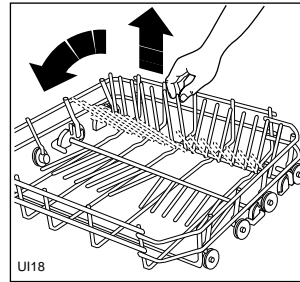

To lower the prongs: slightly pull them upward and let them drop down (see picture); to bring them back to the standing position, just pull them up again.

Use of the Upper Basket

The upper basket is designed for plates (dessert plates, saucers, dinner plates up to 24 cm in diameter), salad bowls, cups and glasses; these should be arranged as shown in the pictures. Glasses with long stems can be placed upside-down in the raised cup-racks.

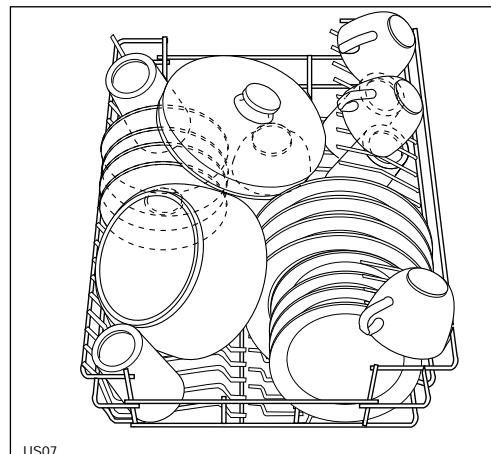
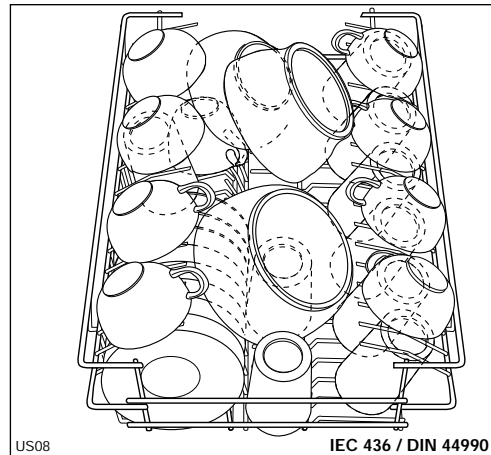

The cup-rack on the left folds upwards to increase your loading flexibility.

Before closing the door, ensure that the spray arms can rotate freely.

Adjusting the Height of the Upper Basket

If washing very large plates (over 27 cm and up to 31 cm in diameter) you can load them in the lower basket after moving the upper basket to the higher position as follows:

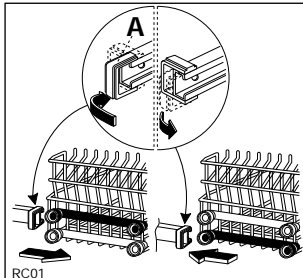

Move the front runner stops (A) of the upper basket outward and slide the basket out.

Refit the basket in the higher position and replace the stops (A) in their original position.

When the top basket is in the higher position it will only take plates up to 20 cm in diameter and you will not be able to use the raised cup racks.

HELPFUL HINTS

For Best Washing Results:

Before loading, remove all scraps of food and soak very heavily soiled pots and pans.

Always arrange saucepans, cups and glasses etc. upside-down.

Tilt items with convex or concave surfaces so that the water drains off easily.

Long items of cutlery such as ladles, carving knives etc. should be positioned horizontally in the upper basket.

Avoid contact between the dishes as far as possible; correct arrangement of the items will give better washing results.

Light items (plastic bowls etc.) should be loaded in the upper basket and arranged so that they do not move during washing.

You will improve drying results by leaving the dishwasher door ajar for at least 15-30 minutes as soon as the programme finishes.

To Save Energy

Do not prewash dishes under running water.

Place dishes in the machine immediately after every meal and wait until the dishwasher is full before washing.

If necessary run the Rinse and Hold programme (see Programme Chart on the following pages), so that any food scraps do not become caked on the dishes while you are waiting to run the complete wash programme.

Select an ECONOMIC programme when the baskets are not very full and/or when the dishes are not very soiled, following the instructions given in the Programme Chart (ECONOMY, BIO, QUICK programmes).

Items not Suitable for Dishwashers

The following should not be washed in the dishwasher:

Cutlery or dishes with wooden or horn handles or glued parts.

Handmade items, wooden objects, antiques or hand-painted china.

Certain types of decoration can discolour when washed in a dishwasher.

Crystal-ware and plastic objects, if not guaranteed dishwasher-proof, should be washed by hand. You are advised to place them in the upper basket and to select a delicate programme.

Certain types of glass can also become opaque after being washed several times in a dishwasher.

Silver cutlery tends to go black if mixed with steel cutlery. Place it in the cutlery basket separate from the others.



















Iron and cast iron objects can rust and stain other items.

Aluminium tends to go black; copper, pewter and brass tend to stain.

Caution: You are advised not to load very small items which can fall through the baskets.

Note: When buying new dishes, ensure that they are dishwasher-proof.

Washing programmes

Programmes	Type of load	Quantity of food scraps Type of soil	Programme Knob Setting	Required push- buttons	Recommended quantity of detergent		Cycle description
					in the dispenser on the door	on the dispenser lid	
INTENSIVE 70°C		Heavily soiled, dried up and containing starch (i.e. pasta, rice, semolina, potatoes, egg, sauces, roast).	A	  	2 level dessert spoons (20 g)	1/2 dessert spoon (10 g)	Prewash up to 55°C Main wash up to 70°C 2 cold rinses 1 hot rinse up to 65°C Hot air drying
* NORMAL WITH PREWASH 65°C	Pots - Pans Crockery	Normally or heavily soiled, also dried up and/or containing starch (i.e. pasta, rice, semolina, potatoes, egg, sauces, roast).	A	 	2 level dessert spoons (20 g)	1/2 dessert spoon (5 g)	Cold prewash Main wash up to 65°C 1 cold rinse 1 hot rinse up to 65°C Hot air drying
NORMAL NO PREWASH 65°C		Lightly soiled, also dried up and/or containing starch (i.e. pasta, rice, semolina, potatoes, egg, sauces, roast).	B	 	2 level dessert spoons (20 g)	/	Main wash up to 65°C 1 cold rinse 1 hot rinse up to 65°C Hot air drying
ECONOMY WITH PREWASH 55°C	Crockery	Normally soiled, not dried up and starchless (i.e. meat, cooked or uncooked vegetables, milk, coffee, drinks).	A	  	2 level dessert spoons (20 g)	1/2 dessert spoon (5 g)	Cold prewash Main wash up to 55°C 1 cold rinse 1 hot rinse up to 55°C Hot air drying
BIO WITH PREWASH 50°C	Pots & Pans Crockery Cutlery	Lightly soiled, also dried up and/or containing starch (i.e. pasta, rice, semolina, potatoes, egg, sauces, roast).	A	  	2 level dessert spoons (20 g)	1/2 dessert spoon (5 g)	Main wash up to 50°C 1 cold rinse 1 hot rinse up to 55°C Hot air drying
** QUICK 55°C	Crockery Party crockery	Normally soiled, not dried up and starchless (i.e. drinks, cakes and pastry, salad, sliced ham, cheese). Due to the shortness of this programme, no drying phase is provided.	C	  	1 heaped dessert spoon (15 g)	/	Main wash up to 55°C 1 cold rinse 1 hot rinse up to 55°C
RINSE & HOLD		Partial load to be complete later. This programme does not require any detergent.	D	 	/	/	1 cold rinse (to avoid food scraps from sticking to the crockery).

* **This programme is equivalent to IEC436/DIN44990:**

Standard place settings: 9.

Recommended quantity of detergent: 20 g in the dispenser
5 g over the dispenser lid.

** This is a special programme for quick washing (approx. 40 minutes) a full load of lightly soiled dishes, glasses and crockery (except pots) so that you may re-use them promptly. Due to the shortness of this programme, no drying phase is provided.

Operating Instructions

1. Check that the filters are clean

(see cleaning instructions)

2. Check that there is salt and rinse aid

3. Load the dishes

Remove larger scraps of food.

Pull the lower basket out and arrange the saucepans, plates and cutlery in it.

Pull the upper basket out and arrange the plates, saucers, glasses and cups etc. in it.

Slide the baskets back into the machine.

Ensure that the spray arms can rotate freely.

4. Measure out detergent

Pour the required amount of detergent into the dispenser according to the indications in the Washing Programmes chart and close the lid.

5. Set the programme

The selection of a programme occurs with the door partially opened.

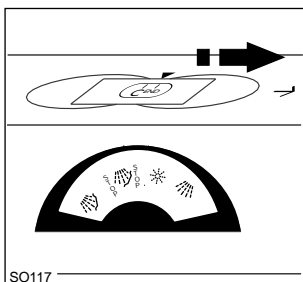

Turn the Programme Selector Dial clockwise until the letter of the programme you wish to select corresponds with the Programme Marker on the control panel.

6. Select the temperature

Select the temperature according to the instructions in the Washing Programmes chart (see "Required push-buttons").

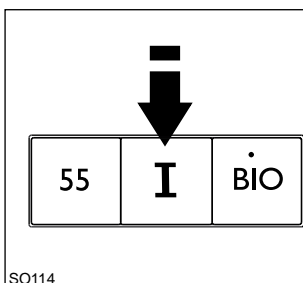

When the **I** button is depressed, the prewash is at 55°C and the main wash at 70°C.

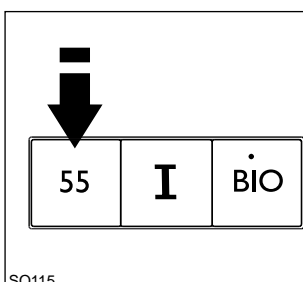

When the "55" button is depressed, any prewash is with cold water and the main wash at 55°C.

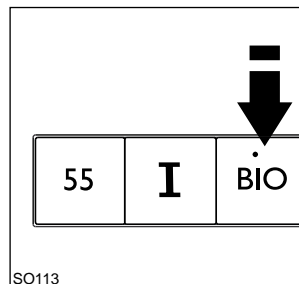

When the "BIO" button is depressed, any prewash is with cold water and the main wash at 50°C, suitable for compact and tablet detergents containing enzymes.

If any of these buttons are not depressed, the prewash is with cold water and the main wash at 65°C.

7. Start the programme

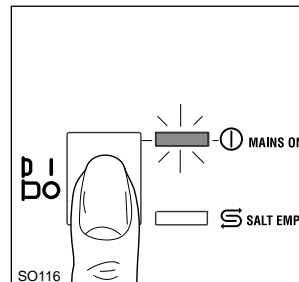

Close the door and depress the ON/OFF pushbutton. The pilot light will come on and the machine will start. If you wish to interrupt the wash at any time press button again.

To restart the machine, depress the same button again and the programme will continue from the point where it was interrupted.

8. At the end of the washing programme

At the end of the washing programme the Programme Marker will correspond with "END" on the Programme Selector Dial. The dishwasher will stop and the pilot light remains on until the ON/OFF button is depressed.

When the programme has finished you are advised to unplug the appliance and turn off the water taps.

Open the door and wait a few minutes before removing the dishes; in this way they will be cooler and drying will be improved.

Empty the lower basket first and then the upper one; this will avoid water dripping from the upper basket onto the dishes in the lower one.

Caution

In general it is not advisable to open the door while the machine is working; if the door is opened however, a safety device ensures that the machine stops.

If you have to open the door while the machine is working, always switch off the appliance first by pressing the ON/OFF button.

Care must be taken if opening the door, as steam will escape.

MAINTENANCE AND CLEANING

Cleaning the Central Filters

(After each wash)

Inspect the central filters (B) and (C) and remove any scraps of food with a brush, under running water.

Filters (B) and (C) are both removed by lifting up the outer one (B) (pulling the central funnel upwards); the smaller filter (C) can then be removed by pressing the two tongues (D).

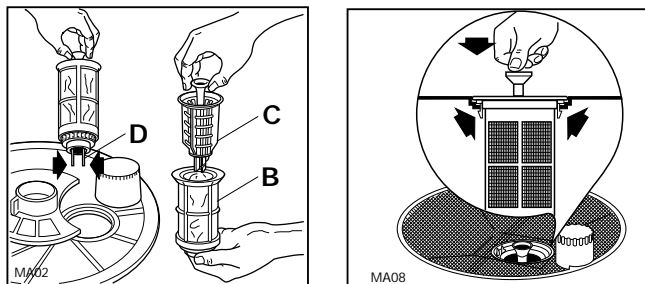

Once cleaned, refit the filters by pressing them down until they click into place.

Cleaning the Large Filter

(Once a month)

Clean the large filter (A) on both sides under running water, using a brush.

To take it out, remove the spray arm by pressing the two tongues (E), turn the ring (F) anticlockwise (towards the left) and then slide the whole part out. Refit the filter following the above instructions in reverse order.

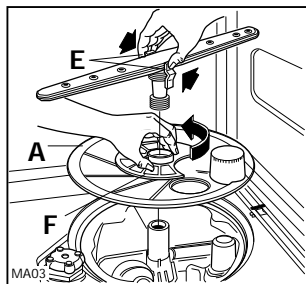

Caution: the dishwasher must not be used without filters.

Incorrect repositioning of the filters will produce poor washing results.

Cleaning of the filters is vital to ensure correct operation of the machine.

Internal and External Cleaning

You must ensure that the seals around the door, the detergent and rinse aid dispensers are cleaned regularly with a damp cloth.

We recommend you carryout a maintenance wash every 3 months, by running a 65° C wash programme without dishes using detergent.

Check that the spray arm nozzles are not obstructed. To remove the bottom spray arm, release it from its securing catches and pull it out.

Clean the external surfaces of the machine and control panel with a soft damp cloth. If necessary use only neutral detergents. Never use abrasive products, scouring pads or solvents (acetone, trichloroethylene etc...).

The upper spray arm

The upper spray arm should not be removed for general cleaning, however if a blockage occurs it can be removed for cleaning as follows:

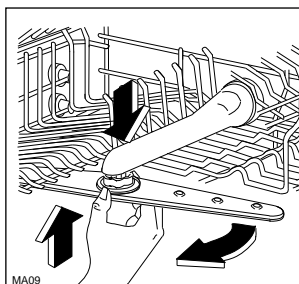

Slide out the upper basket. Push downwards on the water feed pipe, simultaneously push the spray arm upwards and turn it in a clockwise direction.

To reassemble the upper spray arm push downwards on the water feed pipe, simultaneously push the spray arm upwards and turn it anticlockwise.

Prolonged Periods of Non-Operation

If you are not using the machine for any period of time you are advised to:

unplug the appliance and turn off the water;

fill the rinse aid dispenser;

leave the door ajar to prevent the formation of unpleasant smells;

leave the inside of the machine clean.

Frost Precautions

Avoid placing the machine in a location where the temperature is below 0°C.

If this is unavoidable, empty the machine, close the water inlet tap, disconnect the water inlet pipe and empty it.

Moving the Machine

If you have to move the machine (you are moving house etc...):

unplug it;

turn off the water tap;

remove the water inlet and discharge hoses;

pull the machine out together with the hoses.

Caution: avoid over tilting the machine during transport.

SERVICING

Certain problems are due to lack of simple maintenance or oversights and can be solved easily without having to call out an engineer.

The machine will not start

- The door has not been properly closed.
- The plug is not properly inserted in the power socket.
- There is no current at the socket. Check the fuse.

The machine will not fill with water

- The water tap is shut.
- The water supply has been cut off.
- The inlet hose is kinked.
- The water inlet hose filter is clogged.

The machine will not drain

- The drain hose is kinked.
- The sink drain is blocked.
- The drain hose extension is not correct.
- There is no air vent in the end of the drain hose.

The dishes are not clean (poor wash)

- The baskets are too full.
- The dishes have not been arranged properly.
- The spray arms do not rotate.
- The spray arm holes are clogged.
- The end of the drain hose is submerged in waste water (in the sink).
- The filters are clogged.
- The filters are not in position.
- Not enough detergent has been used or it is unsuitable.
- The detergent is old or has gone hard.
- The washing programme selected is too gentle.

Visible lime deposits or white film on the dishes

- The rinse aid has run out or too little is being used.

The machine is noisy

- The dishes are rattling against each other.
- The spray arms are knocking against the dishes.

The dishes are not quite dry

- The dishes have been left too long inside the machine.

The door is difficult to close

- The dishwasher is not level or is not properly built-in.

If, after the above checks, the fault persists, call your local Zanussi Service Centre. Please make sure you give the model and serial number of the appliance. This information can be found on the rating plate located on the right-hand side of the dishwasher door (see picture).

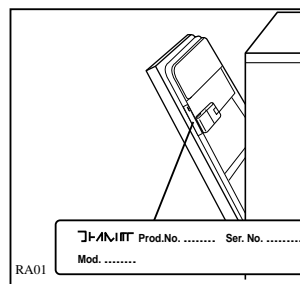

Original spare parts can be purchased from Zanussi Service Centres.

In guarantee customers should ensure that the above checks have been made as the engineer will make a charge if the fault is not a mechanical or electrical breakdown.

Please note that proof of purchase is required for any guarantee service calls.



Free Manuals Download Website

<http://myh66.com>

<http://usermanuals.us>

<http://www.somanuals.com>

<http://www.4manuals.cc>

<http://www.manual-lib.com>

<http://www.404manual.com>

<http://www.luxmanual.com>

<http://aubethermostatmanual.com>

Golf course search by state

<http://golfingnear.com>

Email search by domain

<http://emailbydomain.com>

Auto manuals search

<http://auto.somanuals.com>

TV manuals search

<http://tv.somanuals.com>