

INSTRUCTIONS FOR THE USE AND CARE OF ZANUSSI BUILT-IN COMBINATION MULTIFUNCTION OVEN AND MICROWAVE

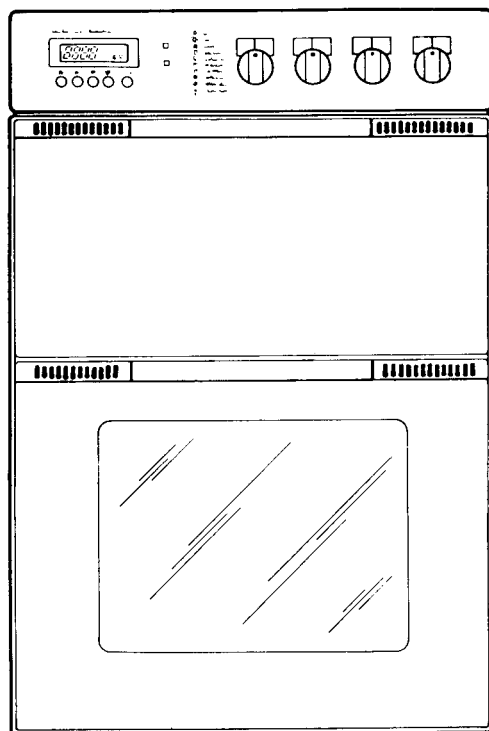

MODEL NOS. FMW 5613
FMW 9613

ZANUSSI
The appliance of science

Warnings

It is most important that this instruction book should be retained with the appliance for future reference. Should the appliance be sold or transferred to another owner, or should you move house and leave the appliance, always ensure that the book is supplied with the appliance in order that the new owner can be acquainted with the functioning of the appliance and the relevant warnings.

Microwave ovens

THESE WARNINGS ARE PROVIDED IN THE INTEREST OF SAFETY. YOU MUST READ THEM CAREFULLY BEFORE INSTALLING OR USING THE APPLIANCE.

This appliance is designed to be operated by adults. Children should not be allowed to tamper with the controls or play with the product.

Any electrical work required to install this appliance should be carried out by a qualified or competent person.

This product should be serviced by an authorised Zanussi Network Service Centre, and only genuine Zanussi spare parts should be used.

It is dangerous to alter the specifications or modify the product in any way.

Items which are overcooked can ignite and cause a fire. Care should always be taken to ensure the correct timing and power setting. When in doubt undercook first and do not leave the appliance unattended during short cooking times. See cooking instructions and your cookery book.

Care and cleaning of the appliance are important. Food deposits should not be left on the interior cabinet. Do not place any object between the oven front face and the door, or allow the door seals to accumulate dirt.

Always be careful when removing protective film from food after cooking as the steam when released can cause burns.

Any foodstuffs with a «skin», e.g. potatoes, sausages etc, must be pierced before cooking in order to allow for the release of steam.

Under no circumstances should live animals be placed in a microwave.

Unplug the appliance if it is to be left for a period of time, e.g. during holidays or long weekends.

Bases of microwave browning dishes and similar cooking vessels get very hot. Care should be taken that the dish does not come into contact with any plastic surface. Wear protective gloves.

Please be cautious when eating food direct from the microwave as items with a high sugar or fat content can be very hot inside.

Only use cooking containers recommended for use in a microwave.

Do not use metal containers, metal glazed china, melamin or cut glass as

cooking containers, or bags with metal ties.

Do not use more than the recommended quantities of aluminium foil in the oven.

Do not use capped bottles, jars or tins.

Do not use the oven for drying any items.

Leave the oven empty at all times when not in use and do not operate the oven when empty.

Do not let the timer continue to operate after removing the food.

Do not attempt to cook or reheat eggs in their shells, they may explode.

Do not attempt to deep fat fry in a microwave.

Do not operate the oven if it is damaged in any way. Under no circumstances should you attempt to repair the appliance yourself. Repairs carried out by inexperienced persons may cause serious injury. Consult your local Zanussi Network Service Centre. Always insist on genuine Zanussi spare parts.

Warnings

It is most important that this instruction book should be retained with the appliance for future reference. Should the appliance be sold or transferred to another owner, or should you move house and leave the appliance, always ensure that the book is supplied with the appliance in order that the new owner can be acquainted with the functioning of the appliance and the relevant warnings.

Built-in ovens

THESE WARNINGS ARE PROVIDED IN THE INTEREST OF SAFETY. YOU MUST READ THEM CAREFULLY BEFORE INSTALLING OR USING THE APPLIANCE.

This appliance is designed to be operated by adults. Children should not be allowed to tamper with the controls or play with the product.

Any installation work must be undertaken by a qualified electrician or competent person.

It is dangerous to alter the specifications or modify the product in any way.

This appliance should be serviced by an authorised Zanussi Network Service Centre, and only genuine Zanussi spare parts should be used.

Cookers become very hot with use, and retain their heat for a long period after use. Children should be supervised at all times and should not be allowed to touch the hot surfaces or be in the vicinity when in use or until the appliance has cooled after use.

Always ensure that the control knobs are in the «off» position when not in use.

For hygiene and safety reasons, this appliance should be kept clean at all times. A build-up of fats or foodstuffs could result in a fire.

This appliance has been designed for cooking edible foodstuffs only, and must not be used for any other purposes.

Never line any part of the oven with aluminium foil.

Easy clean liners should never be cleaned with any other than soapy water (see cleaning instructions).

Before any maintenance or cleaning work is carried out on the appliance, always turn off the isolator switch at the cooker point, and allow to cool.

Ensure that the anti-tip oven shelves are put in place in the correct way (see instructions).

Under no circumstances should you attempt to repair the appliance yourself. Repairs carried out by inexperienced persons may cause injury or more serious malfunctioning. Refer to your local Zanussi Service Centre. Always insist on genuine Zanussi spare parts.

Contents

Double oven features	Page 6
When the appliance is first installed	Page 8
Using the microwave oven	Page 9
Microwave oven cleaning and maintenance	Page 12
Using the lower oven	Page 13
Cleaning the lower oven	Page 19
What happens if something goes wrong	Page 24
Zanussi guarantee conditions	Page 25

Double oven features

The FMW 5613 - FMW 9613 consist of two ovens. With the upper one a microwave oven, you can enjoy the speed and convenience of a compact microwave oven. Be sure to carefully read this Use and Care Manual to learn how to fully use the oven.

Microwave cooking enables you to cook, re-heat, simmer, defrost and even hold warm with speed and convenience. Because microwave cooking is cool cooking, the cavity and the dishes are easy to clean. Basic cooking techniques are as important when cooking by microwaves as they are in conventional cooking, take a little time to become familiar with them.

Start with something easy, heat a cup of coffee for 1-2 minutes on high but open the door at any time to check the temperature. Try heating up a dinner serving on a plate, it will take 2-3 minutes on 8 depending on the evenness and temperature of the foods, look for steam or feel the food to tell when it is hot enough for you. When you are cooking open the door at any time to check results. You can always add time gradually, a few seconds at a time, until you have the result that you are looking for.

The lower oven contains two systems by which you may cook, therefore enabling you to make your own choice. A brief description of each system is given below and full advice on their use is given in the cookery book which accompanies this cooker.

Cooking with the oven may be manual or automatic. The programmer includes a digital clock, a minute minder and controls by which the oven can be set to switch on and switched off unattended.

The oven light will show when the oven is on ie., whenever the control knobs are turned, whilst the indicator lights show the behaviour of the thermostat during cooking.

Conventional Cooking

This traditional cooking method has been incorporated to enable you to use your favourite recipes without adaptation. It is excellent for one shelf baking and for cooking foods with a high egg content and in which an even rise is essential.

Conventional Grilling

The control is thermostatic making grilling completely variable.

Ventilated Grilling

This cooking system gives an exceptionally fine finish to meats, resulting in a succulent spit roast effect for all joints, thick cuts of meat, duck, chicken and some fish. Instructions for using this system of cooking will be found in the Zanussi cookbook.

Cuisinair Cooking

The fan ducted system that will roast, grill or bake at the same time with very little flavour transference and on any shelf level. This method of cooking, using lower temperatures, will give a saving in energy and reduce the amount of cleaning needed in your oven.

Defrost

On this setting, which is not a cooking position, the fan is used on its own which moves the cold air inside the oven and thus assists the defrosting of frozen foods.

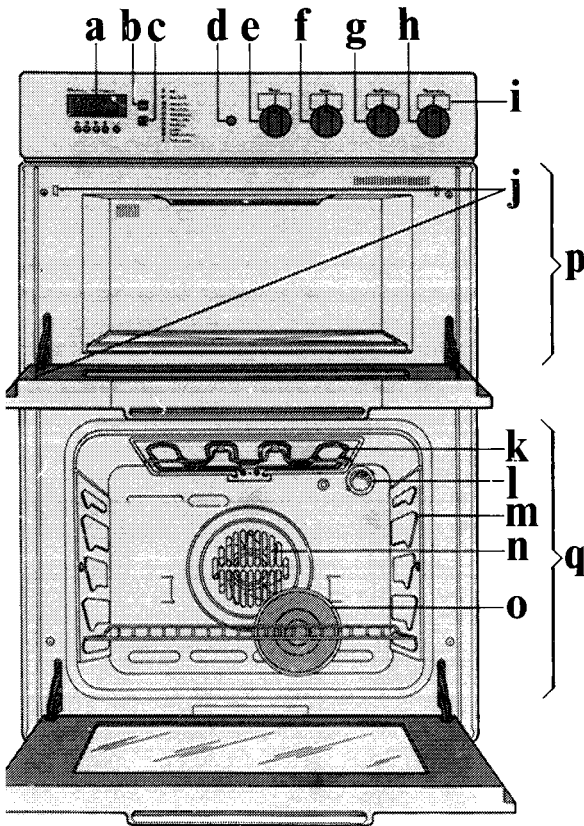

The internal dimensions are:

	Top Oven	Bottom Oven
Height	200 mm	325 mm
Width	420 mm	420 mm
Depth	370 mm	390 mm
Capacity	31 litres	53 litres

- a - Electronic programmer
- b - Upper oven indicator light
- c - Lower oven thermostat light
- d - Start button
- e - Time Control Knob
- f - Variable Power Control Knob
- g - Lower oven selector knob
- h - Lower oven thermostat control knob
- i - Dials
- j - Safety Interlock System
- k - Grill
- l - Interior light
- m - Removable oven liner panels
- n - Fan
- o - Removable grease filter
- p - Upper oven (Microwave oven)
- q - Lower oven

Fig. 1

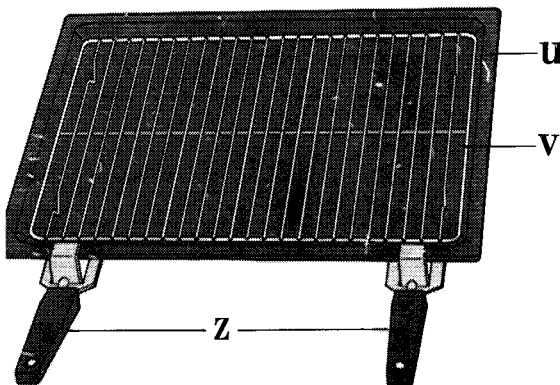

- u - Grill/roasting pan, large
- v - Reversible grill pan insert
- z - Removable handles (2 off)

When the appliance is first installed

Once the appliance is installed the protective materials applied in the factory must be removed.

The plastic film covering some external parts can be removed by wiping with a cloth dipped in methylated spirit.

Other protective materials will burn off if the controls of the lower oven are turned to **MAX** and then allowed to run empty for 45 minutes. This will also remove any unpleasant odours.

Using the microwave oven

To ensure maximum satisfaction from your microwave oven we would like to advise you of some precautions to observe when using your new microwave cooking appliance.

Before using for the first time be sure that all packing materials are removed. **DO NOT** use the oven for storage when it is not in use.

DO NOT attempt to run the oven with no food in it.

DO NOT let the timer continue to operate after removing food, return the timer to zero.

DO NOT attempt to cook or reheat eggs in the shell in the microwave oven, they may explode.

Above all this is a cooking appliance designed to prepare food.

Whilst microwave ovens do not generate heat to cook food, the food item and possibly the container may become hot.

This is particularly so when using a browning dish.

Therefore, precautions that are taken with conventional cooking should also be observed when cooking with microwaves; care must be taken not to place a very hot dish directly onto the inner lining of the glass door.

It is important to remember that it is possible to burn **all** foods if they are cooked for too long.

Safety precautions

DO NOT attempt to operate the oven with the door open by tampering with the safety-interlocks.

DO NOT place any object between the oven front face and the door or allow the sealing surfaces to accumulate dirt.

DO NOT operate the oven if it is damaged in any way.

DO NOT attempt to have the oven adjusted or repaired by anyone other than qualified personnel, trained by the manufacturer.

DO NOT use metal cookware in the oven.

WARNING

DO NOT OVERCOOK FOODS

Overcooking foods can result in dehydration and subsequent fire.

Jacket potatoes, and foods with a high sugar content such as those containing dried fruits, are particularly vulnerable.

In the case of fire unplug the oven and **DO NOT** open the oven door.

Cookware

As microwaves heat only the food, it is possible to serve in the same dish you used for cooking. This dish is warmed only slightly through the heat of food. You can cook in almost any type of ceramics except those with gold, silver or platinum decoration. However, it is recommended to use completely baked ceramic dishes. Any heat resistant cookware can be used. However care should be taken when using fragile glassware since abrupt heating and cooling may break them. Some plastics, such as melamine or urethane, are not recommended because microwaves may warp or crack

them through heating by microwaves or conduction of heat from the food. For further information, see your microwave cookbook.

Tips on using the microwave oven

Be sure to carefully read your cookbook and become familiar with the results to expect.

Always start with the minimum cooking time given in the book and add time as needed to obtain the doneness desired.

Each recipe gives you a suggested cooking time and indication of the desired result. Use the cooking time as a guide and follow the desired result test carefully.

The door can be opened at any time during the cooking operation; the oven will automatically stop cooking and the time setting will maintain until the door is closed, and the start button depressed.

A microwave oven is used for defrosting, heating or cooking foods. It should not be used for such things as drying non-food items such as flowers, canning or cooking or re-heating hard cooked eggs with or without shell.

Be sure to read each recipe carefully as dish size, arrangements, stirring and standing time are important in obtaining good results.

Oven operation

The Variable Power Feature

Variable power includes settings from **10** for full power to **1**. The **10** setting provides the greatest speed of microwave cooking. The settings between **10** and **1** represent decreasing amounts of microwave energy.

This feature gives you total flexibility in

choosing the speed for microwave power of cooking which will give you the best result for each type of food. As with conventional cooking some foods require slower or more gentle microwave cooking. Other foods need to cook more slowly so heat from the outside has enough time to conduct into the centre of the food.

Variable power gives you the flexibility to choose the microwave speed that is right for the food you are cooking.

Basic uses are as follows:

Power level	% power	General uses
1	10	Holding food warm
	20	Softening butter - raising bread
* 0	30	Defrosting
	40	Warming syrups and sauces
5	50	Slow cooking
	60	Heating frozen meal dishes, eg. fish pies, curries, casseroles
7	70	Start cakes - cook soups and stews
	80	Reheat plated and leftover food
10	90	Reheating larger items
	100	Full power for vegetables, fish, hot beverages, grill, preheating microwave browner

The oven light will show when the oven is on whenever the control knobs are turned, the indicator lamp  will glow during the cooking time.

Operating with time & variable power

Each recipe in the cookbook gives the approximate cooking time. Start with the shorter time and add time if needed. The cookbook is only a guide, as food temperature and density can vary the time.

1. Open the door (interior light comes on automatically).
2. Place the food item inside the oven.
3. Set the appropriate power setting (Fig. 2) for your food (see cookbook).
4. Set timer (Fig. 3) for desired time by turning clockwise.

5. Close door and push the start button \diamond (d - Fig. 1), the indicator lamp will come on and the oven will start cooking. The door may be opened at any point to check the food, even if time is left on the dial.

The timer will maintain the time setting. To continue close the door and push the start button again.

6. When the time is up, a bell rings once and the oven turns off automatically.

Warning

The glass tray of the microwave oven may be used only in the upper oven and in no case used in the lower oven, otherwise said shelf could be damaged.

Fig. 2

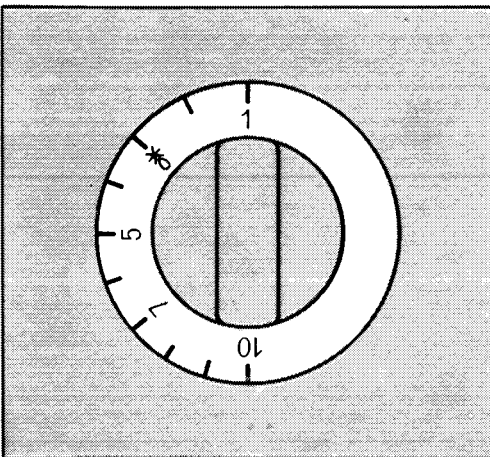
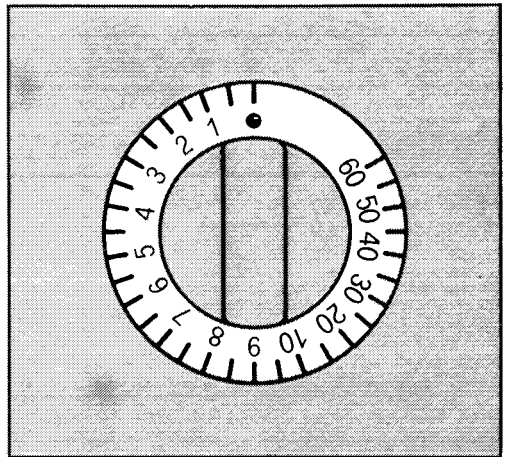

Fig. 3



Microwave Oven cleaning and maintenance

Your microwave oven requires a minimum of maintenance. To keep it free from grease and soil build-up, the microwave oven should be cleaned with a damp cloth after each use. A soft nail brush can be used to remove stubborn stains. Use only a mild detergent, water and a soft, clean cloth to clean the oven facia and interior surfaces. Odours can be eliminated from the inside of the oven by boiling a solution of one cup of water and several tablespoons of lemon juice in the oven for 5-7 minutes.

This also helps in loosening any soil which has dried on the oven. Be careful not to scratch the door and interior surface.

Wipe out excess moisture after each use.

Do not use: Abrasive cleaners, cleaning pads or steel wool.

It will be necessary occasionally to remove the glass tray for cleaning. Wash it in mild detergent solution and thoroughly dry it before returning it to the oven.

Oven Should Not be Used for Storage

Be sure the oven is cleaned carefully after every use and is not used for storage of paper products, books or cooking utensils.

Important

The microwave oven door is not user removable. Only service personnel are entitled to do repair or adjustment.

Questions and answers

- Q.** What happens if I accidentally operate the microwave oven with no food in it?
- A.** While such accidental use for short periods of time does not damage the magnetron, it is not recommended.
- Q.** Is eating food cooked in a microwave harmful?
- A.** Microwaves are simply a source of heat energy just like gas and electricity. All three produce cooking in the food itself. Food cooked in a microwave oven is not harmful to eat.
- Q.** Why do I have moisture in the microwave oven after cooking?
- A.** The moisture on the inside of your microwave oven is normal and nothing to worry about. It is caused by the steam from the cooking food hitting a cool oven surface. Wipe excess moisture from inside of oven after each use.
- Q.** What causes the oven interior light to dim when using variable power?
- A.** This is normal and indicates that the oven is operating and cycling normally.
- Q.** Foods cooked in a microwave oven seem to cool off faster than conventionally cooked foods. Why is that?
- A.** Often the dish used to store foods in the refrigerator is used for heating in the microwave oven. In this case, the cold dish absorbs heat from the food. It may be necessary to heat the food for additional time.

Using the oven (Multifunction)

The multifunction oven makes it possible to carry out various types of cooking, depending on the nature of the food, its firmness and volume.

All cooking must be done with the oven door closed.





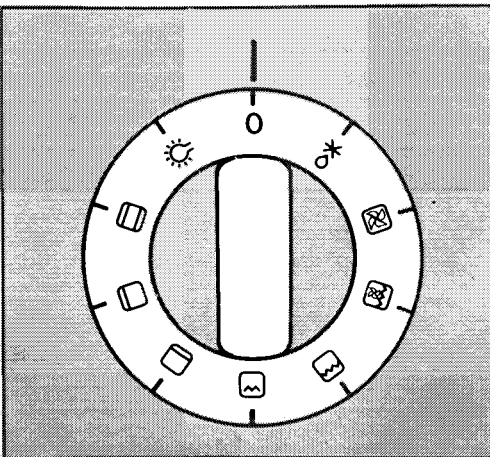



The oven and pilot light remain on with all cooking functions. The oven control knob symbols are listed together with a brief description of the functions (a more detailed explanation of the functions and how to use them are given in the «Art of Cookery» book).

Fig. 4



Oven control knob (Fig. 4)

By turning this control knob, you can select any of the following functions:

-  Oven light, this will come on whenever the oven is in use.
-  Traditional cooking, uses the top and bottom element; this function will enable you to use your favourite recipes without having to adapt the temperatures. It is necessary to pre-heat the oven in this instance. **PLEASE NOTE WHEN USING THIS OVEN FUNCTION YOU MUST REMOVE THE BOTTOM LINER PANEL.**
-  Top oven element only, enables you to finish off dishes on the top only.
-  Bottom oven element only, enables you to finish off dishes on the bottom only. **PLEASE NOTE WHEN USING THIS OVEN FUNCTION YOU MUST REMOVE THE BOTTOM LINER PANEL.**
-  Inner grill element only. (This element is removable).
-  Inner and outer grill elements.
-  Ventilated grilling, gives a spit roast effect to all joints. Using this system eliminates the need to turn food during cooking, although large food items may require to be turned half way through the cooking time.
-  Cusinair cooking: this fan ducted system will allow you to roast or bake at the same time with very little flavour transference, and on any shelf. For

this function, the circular element and fan behind the back wall of the oven are used.

- *  Defrost setting (N.B. this is NOT a cooking position). This position is intended to assist thawing of frozen foods.

Thermostat control knob (Fig. 5)

By turning the thermostat control knob clockwise you select the cooking temperature. Temperature selection starts at 50 °C and is marked in 25 °C increments up to maximum, where the temperature at the center of the oven will reach approximately 280 °C, the thermostat controlling the temperature is totally variable, so it is possible to select temperatures between those marked. The MAX setting is particularly suitable for grilling.

Once the oven temperature has been selected, the temperature light will come on and remain on until the oven has reached the correct setting; after that it will come on and off with the thermostat showing how the temperature is being maintained.

During cooking the oven door should be opened as little as possible to avoid heat loss and so excessive electricity consumption.

Fig. 5

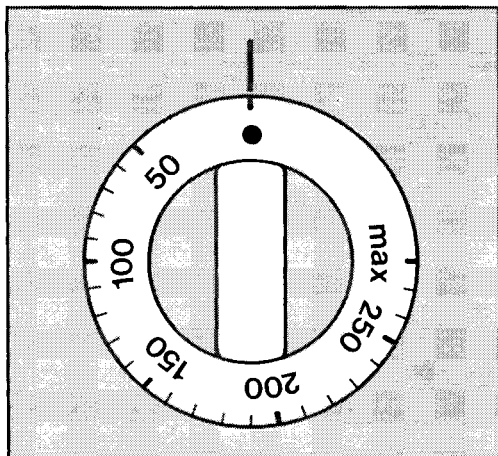

The electric grill

To switch on the grill turn the oven control knob to ☐ or ☐ , then turn the thermostat knob to the required temperature setting.

Turning the oven control knob to the ☐ symbol operates the inner element only, when the oven control knob is turned to the ☐ symbol both the inner and outer elements, thus providing a larger grilling area. This is known as a dual element grill.

Foods to be grilled should be placed on the wire trivet in the grill pan.





The trivet can be positioned either way up to give the required distance from the element.

Cooling fan

The oven is fitted with a cooling fan located between the two cavities. It is designed to cool the interior of the oven housing and the component parts. Cool air is drawn in through the vents at the bottom of the oven which absorbs the residual heat in the appliance housing. The warmed air is then blown out through the vent grille incorporated in the lower oven door handle mechanism. The fan switches on automatically whenever the lower oven is used: in some instances during sustained use of the microwave oven immediately after a long cooking period of the lower oven; and also after long periods of oven use, may continue to function for a few minutes after the appliance is switched off.

Electronic programmer (Fig. 7)

The programmer performs the following functions: presetting of cooking time when using the oven; displaying the correct time of the day.

Symbol	Reference	Function
	A	Setting of the minute minder and display. To stop the buzzer.
	B	Setting and visualizing of the cooking period.
	C	Setting and visualizing of the end time of the cooking period.
	D	Manual operation
	E	Setting of the times (forward/backward)

Operation pilot lamps

The lighting up of a pilot lamp indicates that the relevant function is operating.





Pilot lamp	Reference	Control
	1	General functioning
	2	Programme functioning Manual operation
	3	Automatic functioning



Fig. 7



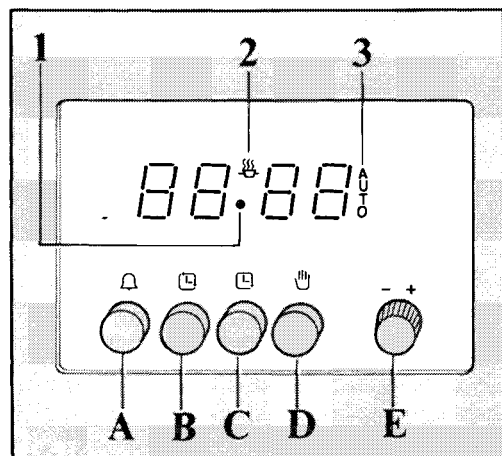



Use

Current time setting

The clock is preset to show the hours from 1 to 24 and the minutes from 0 to 60. When first connecting the appliance to the power supply, the numbers of the display and the pilot lamp  will flash indicating that the clock needs to be set. To enter the current time proceed as follows:

simultaneously depress pushbuttons  (A)  (B) and turn knob - + (E) as required until the correct hour and minutes are entered.



The electronic clock starts when you release pushbuttons  (A) and  (B) (pilot lamp  off and lamp  switched on).

For further resetting repeat the above sequence.

Setting the minute minder with sound signal (buzzer)

The minute minder can be used only with the programmer set on manual operation (knob (D) depressed).

The maximum programmable time for the buzzer is 23 hrs. and 59 mins. Proceed as follows to set the minute minder:

depress knob (D) (pilot lamp  switches off and lamp  switches on);

depress pushbutton  (A) and at the same time turn knob - + (E) and set the desired time period.

Release pushbutton (A).

When the programmed time is up, the buzzer will ring for 2 minutes unless it is switched off by depressing pushbutton  (A).







The minute minder, even though signaling other functions, will always buzz for a maximum of 2 minutes unless interrupted by depressing pushbutton  (A).

Semi-automatic operation of the oven

It is possible to start cooking immediately and to programme the period of the cooking process.

The maximum programmable cooking period is of 23 hrs. and 59 mins.

Place the food to be cooked into the oven, turn the selector and thermostat Knobs (Fig. 4 and 5) to the desired setting and proceed as follows:



depress pushbutton  (B) and, keeping it depressed, enter the required cooking period with knob - + (E); when you release pushbutton  (B) pilot lamps  and  will remain switched on indicating that the programme is operating. At the end of the cooking process the buzzer will ring. At the same time pilot lamp  switches off and pilot lamp  flashes; to switch it off depress pushbutton (D), lamp  switches on.





Automatic operation of the oven

Cooking can be started and finished automatically.



The maximum programmable cooking period is of 23 hrs. and 59 mins.

Place the food to be cooked into the oven, turn the selector and thermostat knobs to the desired setting and proceed as follows:



depress pushbutton  (C) and, keeping it depressed, enter the required end time of the cooking period with knob - +; when you release pushbutton  (C) pilot lamp  will remain switched on indicating that the desired function has been set.

Depress pushbutton  (B) and, keeping it depressed, enter the required cooking period with knob - + (E); when you release pushbutton  (B) pilot lamp  will remain switched on and lamp  switches off indicating that the programme is operating.

When the cooking starts pilot lamp  switches on, at the end of the cooking period the buzzer will ring.

When the buzzer stops pilot lamp  switches off. At the same time pilot lamp  flashes; to switch it off depress pushbutton (D) (lamp  switches on).

Manual (non-automatic) operation of the oven

The oven may be operated manually i.e. without programming. In this case it is necessary to depress pushbutton (D) (pilot lamp  switches off and lamp  switches on).

Power cuts

In case of a power cut all data stored in the programmer are cancelled (i.e. current time, presetting and operating programmes). When power is restored, the display starts flashing (digits on zero) indicating that it needs to be set.

Shelves and runners

The lower oven has four shelf positions moulded into the cavity wall. The auto-stop feature is achieved by the form of both shelf and oven wall. As the shelf is moved outwards horizontally, the form of the oven wall stops the shelf from being totally withdrawn (Fig. 8).

Fig. 8

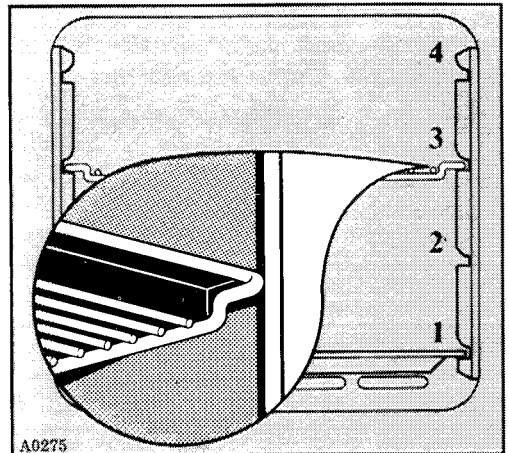

Cleaning the lower oven

Glass door

The door of your oven should be cleaned with a soft cloth soaked in warm soapy water. Do not use abrasive scourers or steel wool.

Shelves

To clean the chrome parts of your oven, soak in warm detergent water and remove stubborn marks with a well wetted soap impregnated pad. Rinse well and dry with a soft cloth. Do not use abrasive scourers or steel wool.

Oven cavity

The enamelled oven cavity and removable enamelled base tray are best cleaned whilst the oven is still warm. First remove the grill element and put the ceramic safety plug into the grill socket.

It is preferable to wipe the oven over with a soft cloth soaked in warm soapy water after each use. However, from time to time it will be necessary to do a more thorough cleaning, using a proprietary oven cleaner, do not use aerosol oven cleaners, abrasive scourers or steel wool.

Important

Please take care to follow precisely the instructions given by the manufacturer of the oven cleaner. Care must be taken to ensure that the oven cleaner does not come into contact with the aluminium and painted surfaces of the appliance.

Special oven linings

The side and back panels of the lower oven care coated liners. These are known as «stay clean» or «easy care». To obtain the maximum efficiency from your liners follow the guide lines carefully for their use and care.

The linings are coated with a special substance which helps to clean itself by a process of oxidization. Although the linings will not remain absolutely spotless they will reduce your oven cleaning chores considerably when used in the correct way.

The linings work most effectively if the splashes are kept to a minimum, and the soil is not allowed to build up, as this will retard the cleaning action. If the oven has been used at low temperatures it is advisable to wipe the soiled linings and oven interior with a soapy cloth.

The linings should be rinsed with a clean cloth and then the oven should be heated for one hour on 200 °C.

Never use abrasive wools or pads or an aerosol oven cleaner on the coated linings.

Removal/replacement of component parts

Prior to undertaking any maintenance work, be sure to disconnect the appliance from the electricity supply.

Grease filter

When roasting meat, be sure to install the special grease filter to protect the fan in the rear wall of the oven from fat splashes. After roasting is completed, remove the grease filter and clean thoroughly with warm soapy water. As it is stainless steel you can safely wash it in the dishwasher.

To remove the grease filter, pull up the protruding tongue and then pull the filter outwards removing it from the rear panel. (Fig. 9).

To remove and clean the panels in the lower oven

If any build up of deposit appears on the lining panels they should be removed for a more thorough cleaning.

Remove the side panels by sliding them towards you and then pulling them away from the oven cavity walls (Fig. 10).

Fig. 9

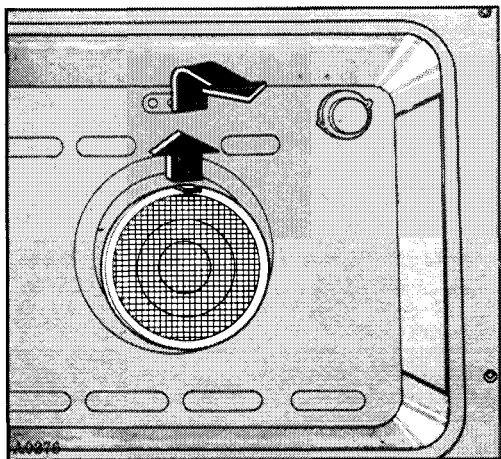
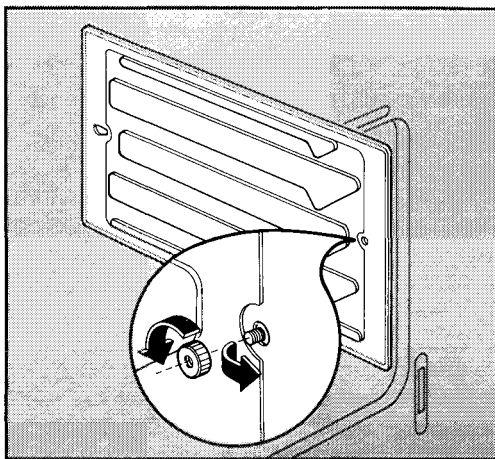

Fig. 10



Warning

Before removing the back panel the oven must be disconnected and the grill element removed, remember to put the ceramic safety plug into the socket (Fig. 6). To remove the back panel use a screwdriver (Fig. 11). This is a good opportunity to clean the back of the rear panel.

Control knobs

These can be removed by carefully pulling them off. Push back on to replace.

Oven lamp replacement

Push in and unscrew anticlockwise the glass cap (fig. 12). Remove the faulty bulb and replace with one that resists to high temperatures (300°C). Electric bulb: 15W, 240V, 50Hz, 300°C, E14. Bulbs are available from your Zanussi Service Network.

Fig. 11

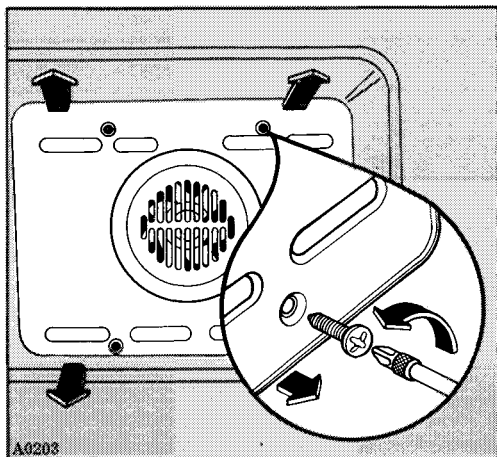
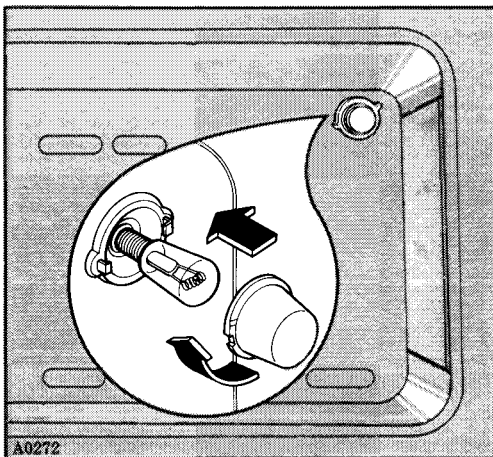

Fig. 12



Removing/replacing the oven door

1. Open the oven door so that it is in the horizontal position.
2. With the aid of a coin move the two retaining discs a quarter turn clockwise, so that the two raised bars are to the left hand side of the hinges (Fig. 13).
3. Raise the door halfway (Fig. 14).
4. At this stage the two hinges on either side of the door must be clasped together simultaneously. The door can then be removed by pulling out and downwards, maintaining the angle (Fig. 15).

To replace the door

1. Clasp the two hinges on either side of the door together simultaneously.
2. Hook the top hinge into the top slot, so that the hook is engaged with the roller.
3. Drop the lower hinge into the lower slot, so that the notch is engaged. Drop the door down so it is in the horizontal position.

Fig. 13

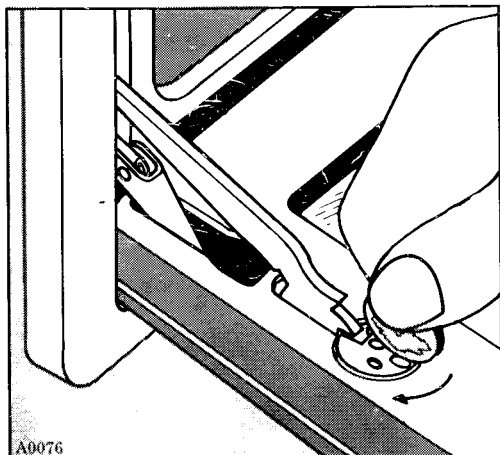
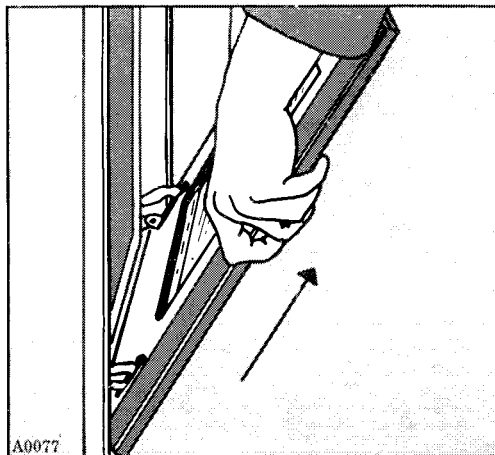

Fig. 14



Note: It is very important when carrying out this operation that both hinges should be located simultaneously.

4. Turn the retaining discs back a quarter turn so that the two raised bars are opposite the hinges.
The door can then be closed.

Fig. 15

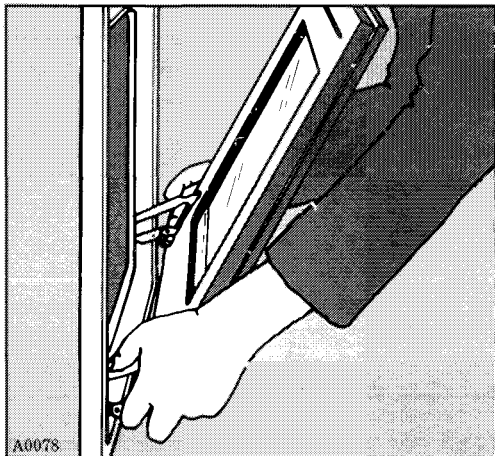

What happens if something goes wrong

If the oven does not come on when cooking manually, first check that the programmer is set for manual, ie. in the () position.

If this is as it should be and the oven still does not come on:

- a) Check that it is plugged in properly.
- b) Check that the socket switch and/or switch from the supply to the oven are ON.
- c) Replace the fuse in the plug, when present, with another of the appropriate rating and check that this plug has been wired up properly.
- d) Check that the socket, when present, is supplying power - do this by plugging in another appliance that is known to be working properly.
- e) Check that the fuse in the fuse box is intact.

If, after all these checks, the oven still does not work, send for your local Zanussi network service centre listed in the telephone directory, under «Z».

It helps to jot down the name and address and telephone number in the space below.

Name

Address

Telephone number

IN-GUARANTEE CUSTOMERS SHOULD ENSURE THAT THE ABOVE CHECKS HAVE BEEN MADE AS THE ENGINEER WILL MAKE A CHARGE IF THE FAULT IS NOT A MECHANICAL OR ELECTRICAL BREAKDOWN.

Please note that it will be necessary to provide proof of purchase for any in-guarantee service calls.

Peace of mind for twelve months

ZANUSSI STANDARD GUARANTEE CONDITIONS

This guarantee is in addition to your statutory and other legal rights which will not be excluded or in any way diminished by the return of this guarantee card.

We, ZANUSSI Ltd., undertake that if, within twelve months of the date of the purchase, this ZANUSSI appliance or any part thereof is proved to be defective by reason only of faulty workmanship or materials, we will, at our option, repair or replace the same **FREE OF ANY CHARGE** for labour, materials or carriage on condition that:

- The appliance has been correctly installed and used only on the electricity supply stated on the rating plate.
- The appliance has been used for normal domestic purposes only, and in accordance with the manufacturer's operating and maintenance instructions.
- The appliance has not been serviced, maintained, repaired, taken apart or tampered with by any person not authorized by us.
- The appliance is still in the possession of the original purchaser.

All service work under this guarantee must be undertaken by a Zanussi Network Service Centre.

Any appliance or defective part replaced shall become our property.

Exclusions

- Damage or calls resulting from transportation, improper use or neglect, the replacement of any light bulbs or removable parts of glass or plastic.
- Costs incurred for calls to put right machines improperly installed or calls to machines outside the UK and the Republic of Ireland.
- Appliances found to be in use within a commercial environment, plus those which are the subject of rental agreements.

or five years

ZANUSSI 5 YEAR COVER CONDITIONS

For a once-only payment you can extend your Standard Guarantee to 5 years. All the conditions and exclusions of the Standard Guarantee apply.

Notes

1. Products supplied as “seconds”, refurbished, damaged or shop-soiled are not eligible for Zanussi 5 Year Cover.
2. The issue of a cover does NOT by virtue of our having done so, nullify the exclusions.

3. The Engineer will need to check the details of your Cover card and may make a charge for his services if it is not presented to him at the time of his call.
4. The date of purchase, or the date of initial payment (deposit) of the appliance will be deemed the date of commencement of cover.
5. Covers issued are not refundable or transferable.

Guarantee Record

Appliance purchased from _____ on _____
Guarantee card no _____ Model no _____
Serial no _____ (These details may be
Your name _____ taken from your
Address _____ Guarantee Record Card)

Instructions for the installation of FMW 5613-FMW 9613 built-in combination Multifunction oven and Microwave

Building-in

It is important that the dimensions and materials of the surround or cabinet into which the oven will be built are correct and will withstand a temperature increase of at least 60°C and that proper arrangements are made for a continuous supply of air to the oven so it does not overheat.

Fig. 1 - Oven dimensions.

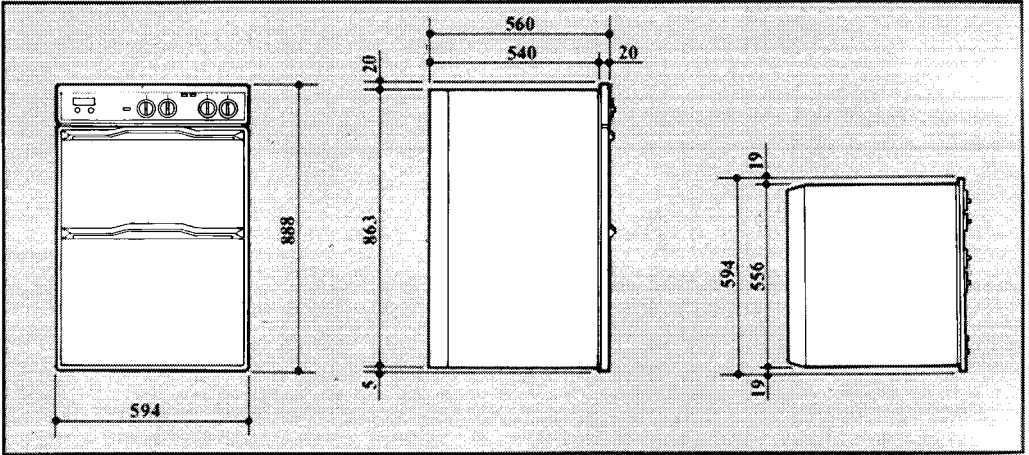
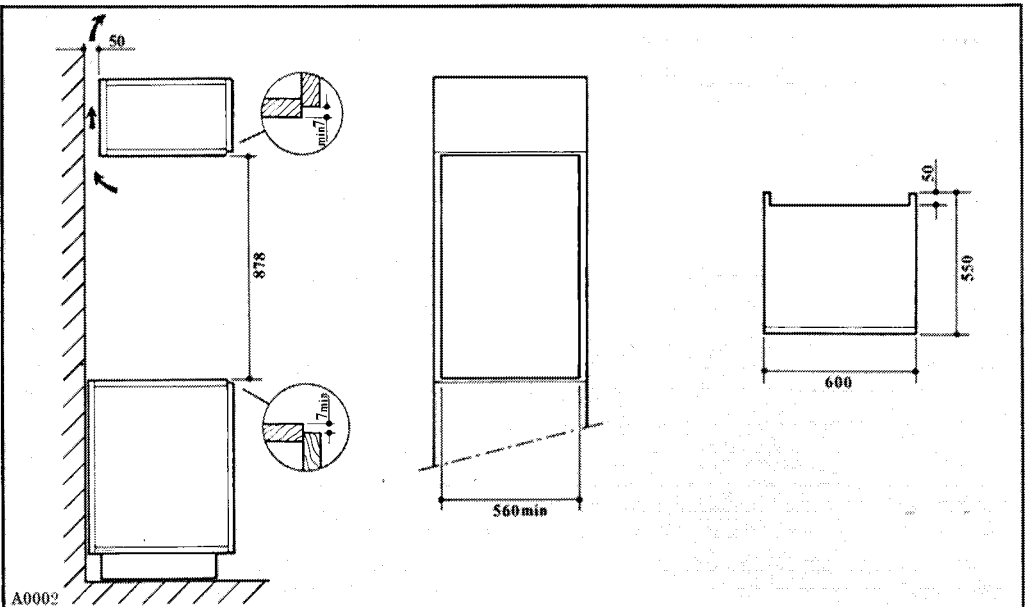

Fig. 2 - Dimensions of the recess for building into a kitchen unit (mm).



Important

To ensure an efficient ventilation, it is necessary to leave the vents at the bottom of the oven clear and unobstructed.

Securing the oven to the cabinet

Fit the appliance into the cabinet recess. Open the oven doors and secure the oven to the kitchen cabinet with six wood screws which fit exactly the holes provided in the oven frame (Fig. 3).

Fig. 3

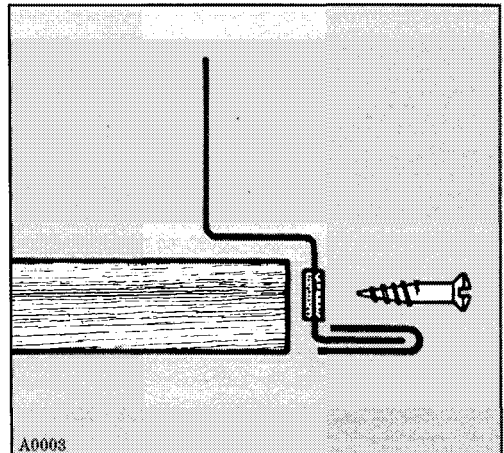

Connecting to electricity

IT IS ESSENTIAL THAT THE ELECTRICAL CONNECTION OF THIS APPLIANCE BE CARRIED OUT BY QUALIFIED PERSONNEL IN ACCORDANCE WITH EXISTING RULES AND REGULATIONS.

The oven is designed to be connected to 240V (50 Hz) electricity supply.

The microwave is rated as follows:

Input power	1400 W
Output power	700 W

Lower oven ratings are as follows:

Total power absorbed	3065 W
Top and bottom elements rating	2000 W
Convection element rating	2500 W
Grill element rating	2000 W
Double grill element rating	3000 W

Maximum load when using top and bottom oven is 4465 W.

The oven has an easily accessible terminal block which is marked as follows:

Letter «L»	Live terminal
Letter «N»	Neutral terminal
	Earth

THIS APPLIANCE MUST BE EARTHED

The cable used to connect the oven to the electricity supply should have a minimum cross section of 6.0 mm².

A double pole cooker control unit with a suitable electrical rating should be used to control the electricity supply to the oven. This control unit must be easily accessible to the user on completion of the installation. This switch must not break the yellow and green earth cable at any point.

In order to connect the oven it is necessary to remove the hatch at the back of the oven to reach the terminal block.

IMPORTANT

After installation and connecting, the cable must be placed so that it cannot at any point reach a temperature of more than 50°C above the ambient temperature.

Before the appliance is connected check that:

The main fuse and the domestic installation can support the load.

The power supply is properly earthed.

The manufacturers disclaim any responsibility should these safety instructions not be carried out.

This appliance meets the requirements laid down in EEC Directive No. 82/499 dated 7.6.82 relating to the suppression of radio and TV interference.

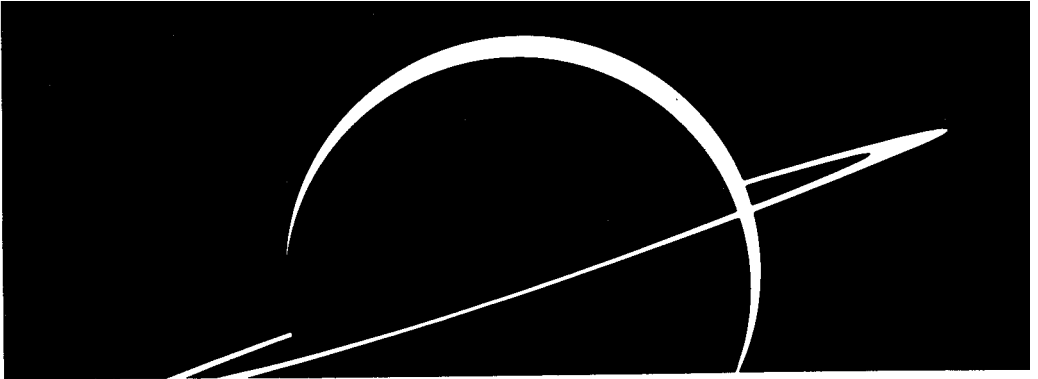

ZANUSSI

The appliance of science

Zanussi Ltd, Zanussi House, Newbury

The information in this manual is correct at time of going to press.
Zanussi reserve the right to alter specifications without notice.

R1611

Download from [Www.Somanuals.com](http://www.Somanuals.com). All Manuals Search And Download.

Free Manuals Download Website

<http://myh66.com>

<http://usermanuals.us>

<http://www.somanuals.com>

<http://www.4manuals.cc>

<http://www.manual-lib.com>

<http://www.404manual.com>

<http://www.luxmanual.com>

<http://aubethermostatmanual.com>

Golf course search by state

<http://golfingnear.com>

Email search by domain

<http://emailbydomain.com>

Auto manuals search

<http://auto.somanuals.com>

TV manuals search

<http://tv.somanuals.com>