

**INSTRUCTIONS FOR THE USE & CARE
OF YOUR ZANUSSI MICROWAVE
MWI776**

A graphic element consisting of a central square box with a thick black border. Inside the box, the text 'ZANUSSI USE & CARE MANUAL' is written in a bold, sans-serif font, stacked in three lines. The box is flanked by four thick horizontal black bars on both the left and right sides, extending towards the edges of the page.

**ZANUSSI
USE & CARE
MANUAL**

It is most important that this instruction book should be retained with the appliance for future reference. Should the appliance be sold or transferred to another owner, or should you move house and leave the appliance, always ensure that the book is supplied with the appliance so that the new owner can be acquainted with the functioning of the appliance and the relevant warnings.

Warnings

THESE WARNINGS ARE PROVIDED IN THE INTEREST OF SAFETY. YOU MUST READ THEM CAREFULLY BEFORE INSTALLING OR USING THE APPLIANCE.

★ Do not use this appliance for any other purposes than the preparation of normal domestic food. Take care to read the instructions regarding loads and timings. Also the recommendations/advice on suitable containers and utensils (see cookery book).

★ *DO NOT OPERATE THE OVEN EMPTY. THE APPLIANCE MUST NOT BE OPERATED WITHOUT FOOD IN THE OVEN, OPERATION IN THIS MANNER BEING LIKELY TO DAMAGE THE APPLIANCE.*

★ *DO NOT OPERATE THE OVEN IF IT IS DAMAGED UNTIL IT HAS BEEN REPAIRED BY A SERVICE TECHNICIAN TRAINED BY THE MANUFACTURER. IT IS PARTICULARLY IMPORTANT THAT THE OVEN DOOR CLOSES PROPERLY AND THAT THERE IS NO DAMAGE TO:-*

(1) DOOR (WARPED) (2) HINGES AND LATCHES (BROKEN OR LOOSENED) (3) DOOR SEALS AND SEALING SURFACES (BROKEN OR CRACKED).

★ *IT IS DANGEROUS FOR ANY PERSON OTHER THAN A SERVICE TECHNICIAN TRAINED BY THE MANUFACTURER TO PERFORM SERVICE REPAIRS.*

★ *AIRFLOW BELOW, ABOVE AND TO THE REAR OF A MICROWAVE*

OVEN SHOULD NOT BE RESTRICTED. (SEE INSTALLATION INSTRUCTIONS).

★ *ALWAYS KEEP THE DOOR SEAL AND DOOR SURFACES CLEAN BY WIPING REGULARLY WITH A DAMP CLOTH, SO THAT ANY GREASE, SOIL OR SPATTERS ARE NOT ALLOWED TO BUILD UP, SUCH BUILD UP COULD RESULT IN LEAKAGE OF MICROWAVE ENERGY FROM THE OVEN.*

★ When heating liquids in your microwave oven, overheating of the liquid beyond boiling point can occur without the evidence of bubbling. This could result in a sudden overspill of the hot liquid and possible injury to the user. The help prevent this possibility the following steps should be observed:-

– Stir the liquid before placing the container in the oven.

– At the end of the heating time allow the liquid to cool slightly before removing the container from the oven using an oven cloth for added protection.

★ This appliance is designed to be operated by adults. Children should not be allowed to tamper with the controls or play with the product.

★ Any electrical work required to install this appliance should be carried out by a qualified person.

★ It is dangerous to alter the

specifications or modify the product in any way.

- ★ Do not use this appliance if it is in contact with water.
- ★ Under no circumstances should live animals be placed in a microwave oven.
- ★ Do not use the oven for drying any items.
- ★ Do not let the timer continue to operate after removing the food.
- ★ No items must be stored in the microwave oven even when the appliance is not being used, as inadvertently switching on the oven could cause a hazard.
- ★ Unplug the appliance if it is to be left for a period of time, e.g. during holidays or long weekends.
- ★ Generally speaking, metal should not be used in the oven when cooking, because metal reflects microwave energy and may cause arcing. Even when metal is used for the limited application (e.g., when shielding chicken legs with foil), it should not come into contact with oven walls.
- ★ Do not use capped bottles, jars or tins.
- ★ Cooking vessels can get very hot. Care should be taken that the dishes do not come into contact with any plastic surface. Wear protective gloves.
- ★ Only use cooking containers recommended for use in a microwave oven.
- ★ Should you wish to use a browning dish, we would suggest that a suitable insulator be placed between the glass tray and the browning dish in order to prevent damage by heat stress. A large heat resistant and microwave proof glass plate (e.g. PYREX), may be used as an insulator. It is important that the recommended preheating time of the dish must not be exceeded.
- ★ Do not cook eggs in the shell. Pressure will build up inside the shell and it will

explode (even after cooking has stopped). Do not reheat cooked eggs unless they are scrambled or chopped. Puncture the yolk before cooking eggs.

- ★ Do not prepare popcorn in the oven. The results are poor and it can be dangerous.
- ★ Do not heat oil or fat for deep frying. The temperature of the oil cannot be controlled and it may overheat.
- ★ In common with other forms of heating food, exceeding the recommended cooking times may result in burning the oven contents and damaging your oven. When cooking foods with a high sugar or fat content (such as: Christmas pudding, mince pies or fruit cake), be sure to follow the cooking instructions carefully.
- ★ Do not reheat drinks in plastic cups, they could melt.
- ★ Do not use a conventional meat thermometer. They may be used outside the oven to check temperature but not during cooking.
- ★ Be cautious when eating food direct from the microwave oven as items with high sugar or fat content can be very hot inside.
- ★ Always be careful when removing cling film and lids from dishes after cooking as the steam when released can cause burns.
- ★ Any foodstuffs with a 'skin', e.g. potatoes, sausages, etc, must be pierced in order to allow for the release of steam.
- ★ Care and cleaning of the appliance are important. Food deposits should not be left on the interior cabinet. Do not place any object between the oven front face and the door.
- ★ The door seal is designed to prevent leakage of microwave energy during cooking. Occasionally moisture may appear around the oven door. This is normal and does not necessarily indicate the oven is leaking microwave energy.

★ Infant feed should not be warmed in a microwave oven once it is in the feeding bottle.

★ We do not recommend the use of any form of microwave checking device which may be available from a number of commercial or retail outlets. In our experience the results from the use of

such devices are variable and the readings obtained from them are not always accurate. If you are concerned about your microwave please contact the appropriate Service Centre or Customer Care Centre.

★ The glass tray must be positioned in the oven during use.

Contents

Contents	page 1
Installation	page 2-3
Specifications	page 3
Cleaning and Maintenance	page 4-5
Features Diagram	page 6
Using Your Oven	page 7
Operating Instructions	page 8-19
Oven Shelf	page 20
Planning and Cooking	page 21
Questions and Answers	page 22
If the oven does not work	page 22
Zanussi Guarantee Conditions	page 23
Zanussi 5 Year Cover	page 24

Installation

Please note: This microwave cooker has been designed to be used in a domestic household. Therefore the guarantee supplied with this appliance may be invalidated if it has been used for a commercial or catering application. After unpacking, ensure that all packing materials have been removed from the oven cavity.

Positioning

For installation instructions please refer to the building-in kit supplied.

NOTE: Do not store cookbooks or the instruction book inside or underneath the oven. Do not place tea towels or utensils over the cooling vents.

Electrical Connection

★ THIS APPLIANCE MUST BE EARTHED

For your convenience and safety, your new Zanussi microwave oven comes ready fitted with a moulded flex and plug. All you need to do is push the plug into a 13 amp power socket and switch on. If for any reason you need to replace this plug with one of your own, you will find the wires inside the flex are colour coded as follows:

GREEN AND YELLOW – EARTH
BLUE – NEUTRAL
BROWN – LIVE

If you fit your own plug, the colours of the wires in the mains lead of your appliance may not correspond with the markings identifying the terminals in your plug. If this is the case proceed as follows:

Connect the green and yellow (earth) wire to the terminal in the plug which is marked with the letter 'E' or the earth symbol \perp or coloured either green or green and yellow.

Connect the blue (neutral) wire to the terminal in the plug which is marked with the letter 'N' or coloured black.

Connect the brown (live) wire to the terminal which is marked with the letter 'L' or coloured red.

The cut off plug should be disposed of to avoid the risk of shock from the plug being inserted into a 13 amp socket elsewhere in the house.

Fuses

The appliance's moulded-on plug is supplied fitted with a 13 amp BS1362 fuse. If this fuse blows you can replace it in the following way:

Remove the plug from the power socket and use a small screwdriver to lever out the red plastic fuse carrier located between the plug's prongs, together with the old fuse. Fit in a new 13 amp fuse and clip it back into the plug. Make sure your new fuse is 'ASTA' approved and complies with BS1362. If the carrier is damaged you can get a new one from your local Zanussi Service Agent, the details of which can be obtained by looking under 'Z' in your telephone directory.

The plug must not be used without the fuse cover fitted.

Safety

★ Check that the supply flex and any other wiring is positioned in such a way that when the microwave oven is operating its temperature at any point is less than 50 degrees C above the ambient temperature of the room.

★ Never remove the rear panel of the oven to gain access to the terminal board. If an extension is required it should be made using the standardised plug and the external cable, which should be capable of carrying the expected load.

★ Check that the fuse and domestic installation are suitable to carry the

electric load of this appliance (see rating plate at the back of the oven).

★ Check that the appliance is properly earthed according to existing rules and regulations.

This appliance meets the requirements laid down in the EEC Directive No 76/889 and amendment 82/499 relating to the suppression of radio and TV interference.

Specifications

MWI776

Voltage	Single phase 240V, 50Hz
Power Required	1470W
Output Power	650W
Microwave Frequency	2450 MHz
Exterior Dimensions	560mm (W) × 395mm (H) × 439mm (D)
Oven Cavity Dimensions	370mm (W) × 270mm (H) × 370mm (D)
Cooking Uniformity	Wave Stirrer (Motor Driven)
Weight	Approx 28 kg

Cleaning and maintenance

Microwave oven cleaning

***THE ELECTRICITY SUPPLY MUST BE DISCONNECTED BY REMOVING THE PLUG FROM THE SOCKET BEFORE CLEANING.**

It is important to wipe up all spillages as these can affect the cooking time. The spillages absorb microwave energy and prolong the cooking time.

To keep the oven free from grease and soil build-up, it should be cleaned with a damp cloth after use. A soft nail brush can be used to remove stubborn stains.

Odours can be eliminated from the inside of the oven by boiling a solution of one cup of water and several tablespoons of lemon juice in the cavity. We would also recommend occasionally wiping the oven interior with a sterilising fluid, e.g. Milton, in the interest of hygiene.

Only use a mild detergent, water and a soft, clean cloth to clean the oven face and other surfaces, and polish dry with a soft cloth or paper towelling. Do not use AEROSOL, CAUSTIC OR ABRASIVE CLEANERS, or scrape the interior surface with knives or other utensils. This could cause the enamel paint to come off, exposing the metal underneath. Any exposed metal could cause sparking or arcing, and further damage to the oven. Wipe out crumbs that fall between the door and the frame with a damp cloth. It

is important that the door seal area is kept clean. If there is a greasy film on the oven door, a small amount of vinegar water can be used to remove the grease. Rinse with cold water and polish dry with a soft cloth or paper towelling.

ALWAYS KEEP THE DOOR SEAL SURFACES CLEAN BY WIPING REGULARLY WITH A DAMP CLOTH, SO THAT ANY GREASE, SOIL OR SPATTERS ARE NOT ALLOWED TO BUILD UP. SUCH A BUILD UP COULD RESULT IN LEAKAGE OF MICROWAVE ENERGY FROM THE OVEN.

Regularly check the door seal area, which is formed by the inside face of the door, for any signs of damage. If such damage is seen do not use the oven until the damage has been repaired by a Service Technician trained by the manufacturer.

The glass tray may be removed and taken to the sink to be cleaned or washed in the dishwasher. Care should be taken to avoid dropping the glass tray. Although it is made of toughened glass, it will break if not handled with normal care. Do not use oven without glass tray in position.

The glass splash shield may be removed for cleaning, but must be installed before operating the oven as it is an integral part of the air flow system. To remove, lift the clip on one of the guides and slide the splash shield forward until it can be held with both hands and fully withdrawn. To replace, carefully slide the shield through the guides all the way to the back of the oven, when the clip will automatically drop down to retain the shield.

Light Bulb Replacement

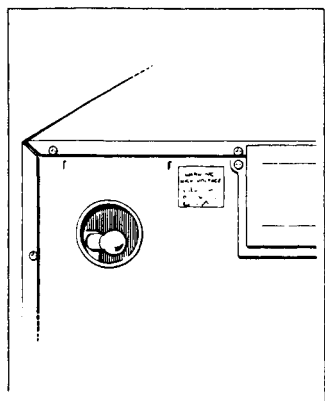

1. Unplug the microwave oven from the power supply.
2. Remove the smaller of the two covers from the rear of the oven by removing the screw.
3. Unscrew light bulb and replace only with a 40W round bulb with E14 screw cap.
4. Replace cover and screw. This cover must be in place before operating the oven.

Features Diagram

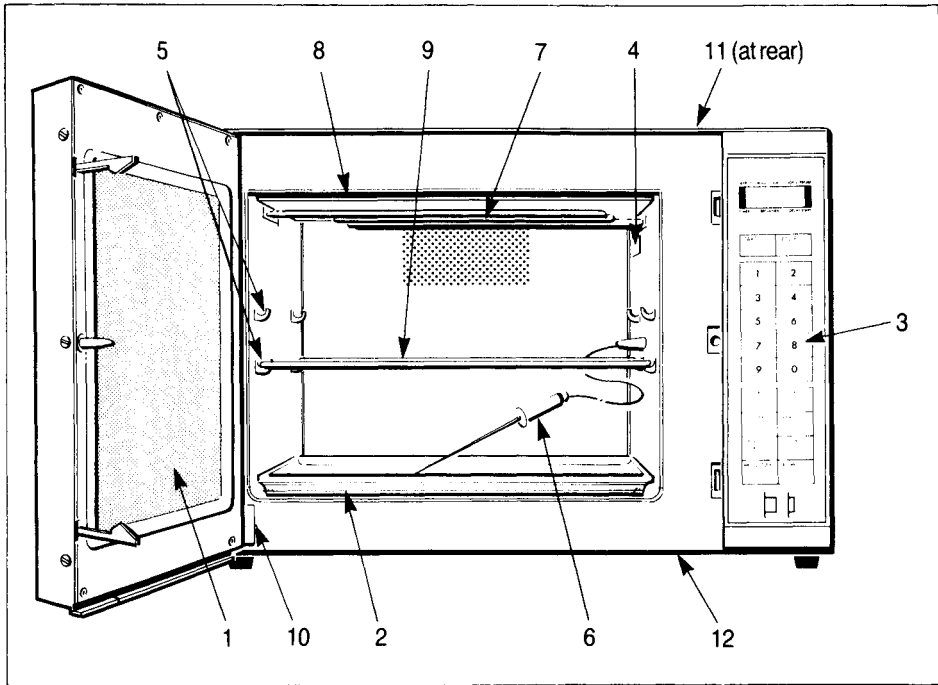

Becoming familiar with the working parts of your microwave oven will help you understand the important operating information on the following pages.

1. SEE THROUGH DOOR lets you check the cooking without interrupting the cooking cycle.

2. REMOVABLE TRAY makes cleaning easy. The tray should always be kept in place when using the oven.

3. CONTROL PANEL.

4. OVEN LIGHT.

5. SHELF SUPPORTS.

6. TEMPERATURE PROBE.

7. BROWNER ELEMENT.

8. GLASS SPLASH SHIELD. This can be removed for cleaning, but must be installed before operating the oven as it is an integral part of the air flow system.

9. METAL SHELF.

10. RATING PLATE located on the face of the oven front adjacent to the hinge.

11. VENTS should be kept unobstructed. Leave at least 2 inches of clear space above the oven for air circulation.

12. AIR INTAKE AREA.

Using your microwave oven

Before using the microwave oven for the first time, ensure that all packaging materials have been removed from both the outside and inside of the oven. Wipe out the inside of the oven with a damp cloth. Check that the door seal and sealing surfaces are not broken or cracked, that the door is not warped and that the hinges and latches are not broken or loosened. If you do find any damage, contact your local Zanussi Network Service Centre. Microwave cooking is very versatile. It enables you to cook, reheat, roast, simmer, hold-warm and even defrost with speed and convenience.

As microwaving is such a new and fast way of cooking, you should be able to be more adventurous as you become more familiar with this method of cooking. To begin with something easy, heat a cup of coffee in a mug for two minutes, but open the door at any time and check if the coffee is as hot as you like it. Next try heating leftovers on a plate. An average serving takes about 2–3 minutes on a medium setting. Look for steam or test the food to see if it is ready.

You can open the door at any stage. If additional time is needed, add it gradually. It is always better to underestimate the cooking time than over estimate.

Every recipe in the cookbook gives the approximate cooking time. Because of factors such as food temperature, dish shape, arrangement of food and density of food it is difficult to give a precise time. **Always start with a shorter time and add time if needed.**

The microwave oven cooks much faster than conventional ovens. It is wise to take special care when you are cooking something for which specific timings have not been recommended. This applies particularly when reheating foods. Always watch the cooking or heating of the food and give it a short cooking time, adding more until you have the required results.

You will soon learn the correct timings for cooking or heating your favourite foods. It is important to remember that it is possible to burn foods if they are cooked for too long, but the burning will occur inside the food first and will only become apparent by smell.

Please remember that the cookbook is only a guide.

Operation of the Control

The oven is operated by touch-sensitive control pads on the control panel. A digital display can show the cooking time and timer or act as an ordinary digital clock. Indicators show which of the cooking functions you have selected. An entry signal tone should be heard each time you touch the control panel to programme the oven, if you do not hear this sound

- 1) You have not used enough pressure in touching the pad.
- 2) You have made an incorrect entry.

In addition to the entry signal tone, 4 bleeps will sound at the end of the cooking cycle.

Make sure the oven is plugged into a power point. When the oven is plugged in, the display will show: flashing on and off.

Press the power switch and the display will show 00:00.

You cannot programme the oven if the door is not closed firmly.

If the electrical supply to your microwave

oven should be interrupted, the display will show : flashing on and off, when the power is restored. Don't forget to reset the clock for the correct time of day.

If you open the oven door during cooking, the timer and cook cycle will hold. After you have shut the door again, press the START pad to continue cooking.

If you press the CANCEL pad during cooking, the selected programme will be abandoned and cooking stops. You will see 00:00 on the display. To restart, choose a cooking programme and press the START pad.

If you pick a programme but want to change it before starting to cook, simply touch the CANCEL pad and reprogramme.

When the timer for all sequences/programmes counts down to zero, the audible signal will sound and 00:00 will reappear on the display. Press the power switch and the display will show the time of day.

Note:

When using the timer only function 00:00 will show at the end of the programme. Press either cancel or clock to show the time of day.

Power Levels

When you touch the power level pad the letter 'H' will show in the display. This indicates that the oven is automatically set to cook at High (100%) power level.

When you change the power level the number which you programme will be shown on the display. For example, if you change the power level to 50% by touching the number 5, the number 50 will be displayed. To check a power level during a cook cycle, simply touch the power level pad to recall the information for 3 seconds. The power level can be changed at any time during the cycle. Simply touch the power level pad and programme the revised power level.

Important

The oven door must be closed to start all programmes/sequences.

The clock



The digital 24 hour clock operates even when the oven is not in use. The clock should always be set and running. While most timing can be done if the clock is not set, the TIME/START feature cannot. The oven should be turned off by the switch button before setting the clock.

To recall the time of day during cooking, simply touch the CLOCK pad and the correct time of day will appear for 3 seconds on the display window.

If no time is set, or the wrong time, (e.g. 33:00), a flashing colon appears in the display window. If the oven is unplugged or the power is off, the time will be lost. When power is restored, the flashing colon will appear to remind you to reset the clock. If an incorrect time appears, touch the CLOCK pad.

To set the clock to the correct time of day.

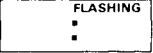
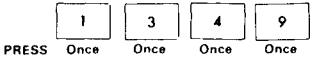
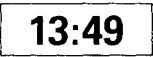
- Suppose you wish to set the clock to 1:49pm (13:49).

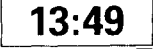

PROCEDURE	PAD ORDER	DISPLAY
1: Touch the CLOCK pad		
2: Touch the numbers 1, 3, 4 and 9 pads		
3: Touch the START pad		

Setting the cook programmes

To cook at Full Power:

As the oven automatically cooks at High level you would normally only need to programme the cooking times required.

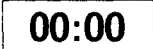
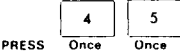
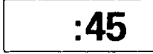
- Suppose you wish to set the cooking time for 45 seconds at full power.

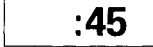
PROCEDURE	PAD ORDER	DISPLAY
1: Push in the switch button		
2: Touch the numbers 4 and 5 pads		
3: Touch the START pad		

The cooking time will count down to zero at the end of all cooking cycles. When the timer reaches zero, the indicators will go out and you will hear four 'beeps'. Microwave energy will stop and the time of day will reappear on the display, after the POWER switch button is released.







If the door is opened during the cooking process, the cooking time in the readout automatically stops. The cooking time starts to count down again when the door is closed and the START pad is touched.

If you have touched START and the oven is operating, you can double-check the cooking function times you have set by touching the retrospective function pad

EXCEPT for any cooking function already in operation or completed. This information will appear on the display window for 3 seconds, then the display will go back to whatever cooking function the oven is in.











Cooking at a different power level

- Suppose you wish to set the cooking time for 20 minutes at 70% power level.

PROCEDURE	PAD ORDER	DISPLAY
1: Push in the switch button	 PRESS	00:00
2: Touch the number 2 pad once, and the number 0 pad three times	  PRESS Once Three Times	20:00
3: Touch the POWER LEVEL pad then the number 7 pad	 	70
4: Touch the START pad		20:00

Using COOK 2 to give two different power levels in one cooking programme. Some recipes require food to be cooked at one power level for a period of time, and a different power level for the remaining period. You can programme the oven to do this automatically.











- Suppose you wish to programme the oven to cook at High (100%) for 8 minutes, and Medium (50%) for 70 minutes. This would give a total cooking time of 1 hour 18 minutes.

PROCEDURE	PAD ORDER	DISPLAY
1: Push in the switch button	 PRESS	00:00
2: Touch COOK 1, then number 8 pad, then 0 pad twice	   PRESS Once Once Twice	8:00
3: Touch COOK 2, then number 7 pad, then 0 pad three times	   PRESS Once Once Three Times	70:00
4: Set the new power level. Touch POWER LEVEL, then number 5 pad	 	50
5: Touch the START pad	 Once	8:00

Using the DELAY/START facility

This enables you to programme the oven to turn on at any time you choose. PLEASE NOTE that if the time/start feature does not work, it is because the clock is not set and running.

- Suppose you want the oven to turn on automatically at 17.30 hours (5.30pm) and cook the food for 35 minutes.





PROCEDURE	PAD ORDER	DISPLAY
1: Push in the switch button	PRESS 	00:00
2: Touch the DELAY/START pad	PRESS 	:
3: Touch the numbers 1, 7, 3 and 0 pads	    PRESS Once Once Once Once	17:30
4: Touch the COOK 1 pad and number 3 pad once, number 5 pad once and number 0 pad twice	    PRESS Once Once Once Twice	35:00
5: Touch the START pad	PRESS 	TIME OF DAY

The 'Hold' indicator light will flash and the time of day will show until it is time for the microwave to start cooking. If the door is opened before cooking begins, touch the START pad again after the door is closed. If this procedure is not carried out, cooking will not start.

Setting the Timer

This facility can be used as a handy timer for many domestic chores. The timer does not control the oven in any way and can only be used when the power switch is not turned on, i.e. when the oven is not being used for cooking. When the timer reaches zero it gives 4 short 'beeps'.

- Suppose you wish to set the timer to 38 seconds.

PROCEDURE	PAD ORDER	DISPLAY
1: Touch the DELAY/START pad	PRESS 	00:00
2: Touch the number 3 pad and the number 8 pad	  PRESS Once Once	:38
3: Touch the START pad	PRESS 	:38

This set time may be changed by touching CANCEL once, then DELAY/START and the new time. Then touch START.

When the time has run out, the display will show 00:00. To restore the clock, touch either CANCEL or CLOCK.





Using the defrost facility

Food is automatically defrosted at a low setting (30%), and you should never attempt to defrost it at a higher power.

The oven automatically cycles on and off which allows the heat to equalize throughout the food. At higher power levels, you will find that before the food is completely defrosted on the inside, the outer edges may begin cooking.

It is important to thoroughly defrost food before cooking.

- Suppose you wish to defrost for six minutes.









PROCEDURE	PAD ORDER	DISPLAY
1: Push in the switch button	PRESS 	00:00
2: Touch DEFROST then number 6 pad once and number 0 pad twice	PRESS  Once  Once  Twice	6:00
3: Touch the START pad	PRESS  Once	6:00

Defrost hold

When using the DEFROST pad, you can programme the oven to automatically start cooking after the defrost time is completed.

There will be an automatic holding time or standing time before the cooking actually starts. The Defrost Hold indicator will flash while this holding time is in progress. During Defrost Hold, the display will count down to equal the original defrost time. During the holding time, temperatures even out throughout the food to give complete defrosting.

- Suppose you wish to defrost food for 2 minutes and automatically cook at on High (100%) for 20 seconds.

PROCEDURE	PAD ORDER	DISPLAY
1: Push in the switch button	PRESS 	00:00
2: Touch the DEFROST pad, then number 2 pad once and the number 0 pad twice	PRESS  Once  Once  Twice	2:00
3: Touch COOK 1, then number 2 pad once and number 0 pad once	PRESS  Once  Once  Once	:20
4: Touch the START pad	PRESS  Once	2:00

PLEASE NOTE: If the door is opened during the Defrost Hold period, the remaining defrost hold period is cancelled, and on closing the door and touching the START pad, the COOK 1 period will start immediately.

Using the browner

The Browner in your microwave gives food a light, golden-brown 'finished' look and adds a little extra crispness to foods. Remember to use heat resistant utensils when using the browner.

The following will give you a guide to browning times. The exact time will depend on the type of food, whether the element is still warm from an earlier browning operation and the amount of browning desired. The food should be browned on the shelf position that places the top of the food close to the element. All excess juices and liquids should be drained before browning.



4 Chicken pieces	10-13 minutes
4 Lamb chops	6-8 minutes
5 Beefburgers.....	8-10 minutes
Victoria Sandwich	6-8 minutes
Meringue Pie	5-6 minutes

Please note a browner element is not a substitute for a full grill on a conventional cooker.



- Suppose you wish to set the oven to brown for 4 minutes.

PROCEDURE	PAD ORDER	DISPLAY
1: Push in the switch button	 PRESS	00:00

2: Place the food to be browned directly under the browning element.
Be sure that the shelf is in the correct position (see Planning and cooking).

3: Touch BROWN, then number 4 pad and number 0 pad twice	 PRESS Once Once Twice	4:00
4: Touch the START pad	 PRESS Once	4:00

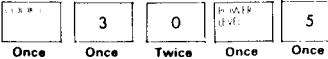
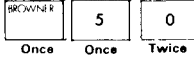
- Suppose you wish to programme the oven to cook a meringue for 3 minutes at 50% power, and then immediately brown it for 5 minutes.

PROCEDURE	PAD ORDER	DISPLAY
1: Push in the switch button	 PRESS	00:00
2: Touch COOK 1, then number 3 pad and number 0 pad twice. Touch POWER LEVEL then number 5 pad	 PRESS Once Once Twice Once Once	3:00
3: Touch BROWNER then number 5 pad and number 0 pad twice	 PRESS Once Once Twice	5:00
4: Touch the START pad	 PRESS Once	3:00

Temperature Probe

Your microwave oven is equipped with a removable temperature probe. It is easy to use but you should follow the steps given here carefully.

To use the Temperature Probe

1. Insert the pointed metal thermometer portion (B) of the temperature probe into the food. It is easier to position the probe correctly if this is done while the food is outside the oven. Be sure to insert the probe at least 25mm/1" into the food.

For casseroles, place the thermometer in the centre of the food. When cooking meat the probe should be inserted from the side so that the tip of the probe penetrates to the centre of the meat, away from boney or fatty sections. For poultry, insert through the breast to thigh area.

2. Place the food inside the oven.
3. Plug the probe jack (A) into the outlet in the cavity wall. A 'bleep' will sound when the probe is securely inserted.
4. Avoid placing the rubber cord (C) directly on or in the food.
5. Programme oven to cook by temperature (see following instructions).
6. When the food reaches the programmed temperature, the oven will turn off automatically. An audible signal will sound 4 beeps and the display will revert to 00 with the probe indicator bar flashing for temperatures below 60°C.
7. Unplug the probe jack from the outlet before removing the food from the oven.

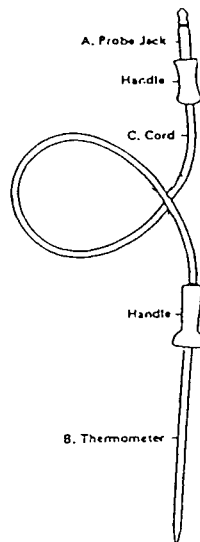

2. The temperature probe should be unplugged and removed from the oven when not in use. Store the probe in a safe, convenient place outside the oven.
3. Carefully wash the temperature probe in warm soapy water and wipe dry. It is immersible, but should not be soaked. Do not wash in dishwasher.
4. Insert the thermometer portion of the probe at least 25mm/1" into the food.
5. The temperature probe should never touch the interior walls or door of the oven.
6. Do not use the temperature probe when browning.
7. The temperature probe is designed specifically for use in this microwave oven. Do not substitute any other probe for this one. The probe cannot be used in conventional cooking or in other microwave ovens.
8. Avoid harsh treatment of the probe. Do not drop the probe. It is a thermometer; handle it carefully.
9. Oven gloves may be needed when removing the temperature probe.

Use and Care of Temperature Probe

1. DO NOT OPERATE THE OVEN EMPTY WITH THE TEMPERATURE PROBE INSIDE. TO AVOID THIS POSSIBILITY, DO NOT LEAVE THE PROBE IN THE OVEN WHEN NOT IN USE.

10. Do not remove the probe from the receptacle or from the food by pulling on the cord. Use the insulated handle.

11. Do not try to force the temperature probe into solidly frozen food. Always defrost before using the probe.

12. Temperature readings are given for some recipes which should be cooked covered. If you wish to use the probe, cover the food with cling film and insert the probe through the cling film.

13. You will often notice a change in the temperature readout after stirring. This is normal and also occurs in conventional cooking.

14. Temperatures may be set from 34°C to 92°C.

15. Important

Only the temperature probe supplied with this oven must be used. Should a replacement be required it must be of the correct type and obtained from Electrolux service organisation

Probe – General Guidelines

- 1.** Always insert the probe into the centre of the leanest/thickest part of the food.
- 2.** Try to ensure the probe doesn't touch any bone and isn't inserted through any fat. This tends to give a false reading.
- 3.** When you first start using the probe, it is a good idea to estimate the time cooking should take. Then, if the temperature rises too quickly, you will know that the probe is not positioned correctly and should be moved. You'll soon learn how best to position the probe.
- 4.** The probe only works well with foods of the same densities e.g. a solid joint of meat (preferably without bone) or all liquid. It would be less effective with cubed meat in liquid.
- 5.** Temperatures for all foods other than meat are only a guideline. Adjust to suit your own personal preference.
- 6.** Ensure probe is fitted so that the metal point doesn't come into contact with the sides of the oven.









Temperature Probe Cooking Chart

Food	Power Setting	Preset Temp	Holding Time	Notes
Beverage				
All water e.g., Tea	High	80°C	–	Place probe in centre of liquid Use ovenware casserole or jug when heating more than one cup
½ water, ½ Milk e.g., Coffee	(100%)	75–80°C		
All milk e.g., Chocolate		70°C		
Chicken (whole)	Med. High	85–90°C	10 mins	Insert probe into leanest part of leg joint
Chicken portion (breast)	(70%)	85–90°C	5 mins	
Fish	Med. High (70%)	64–67°C	–	Insert in thickest part of fish
Lamb (med, well) (well done)	Med. High (70%)	68–71°C 74–77°C	– –	Choose leanest joint e.g., fillet
Mince Meals e.g., Savoury Mince, Bolognaise Sauce	Med. High (70%)	70–80°C	5 Mins	
Pork Loin Roast	Med. High	77–79°C	10 mins	Insert probe into leanest part
Ham Boil in bag	(70%)	77–79°C	10 mins	Insert probe into leanest part
Turkey Boneless Roasts	Med. High	65–70°C	10 mins	Cook breast side down first until temp reaches 50–55°C Turn the right way up. Remove wings. Continue cooking
Whole Turkey	(70%)	85°C	15 mins	
Soup	High	75–80°C		Stir well, halfway through cooking and at end
Tinned Foods (Savoury) e.g., Baked Beans, Spaghetti	High (100%)	80°C		Stir well, halfway through cooking and at end
Tinned Foods (Sweet) e.g., Tinned Rice, Custard	High (100%)	80°C		Stir well, halfway through cooking and at end

To Cook by Temperature

Your oven is equipped with a removable temperature probe which is plugged into the oven cavity wall for cooking by temperature. Directions for correct use of the temperature probe are on page 15.

- Suppose you want to heat a sauce to 54°C on MED HIGH (70%) power.





PROCEDURE	PAD ORDER	DISPLAY
1: Push in the switch button	 PRESS	00:00
2: Place probe in sauce. Insert probe plug in receptacle in cavity wall.		
3: Enter required temperature. Touch number 5 pad then number 4 pad	  PRESS Once Once	:54
4: Touch POWER LEVEL then number 7 pad	  PRESS Once Once	70
5: Touch the START pad	 PRESS Once	-34
NOTE: When temperature is lower than 34°C the display will show - 34°C with probe indicator flashing.		
When the internal temperature reaches 34°C, the display window will show the actual temperature of the food in 2° intervals as it increases to 54°C. At 54°C the oven will automatically cut off and the end of cooking signal will sound. The display will revert to 00 with the probe indicator bar flashing (for temperatures below 60°C). For temperatures above 50°C the oven will automatically operate 'hold' to maintain that temperature until the food is required.		
6: Touch the CANCEL pad and remove probe from receptacle	 PRESS Once	00:00
7: Press the switch button to revert to time of day	 PRESS	TIME OF DAY

Probe Hold Feature

The probe hold feature allows you to keep food at the required serving temperature (60°C or above). Probe hold can also be used to keep food simmering at a specific temperature. Suppose you want to cook poultry to 85°C on MED HIGH (70%) power and then maintain the food at 85°C.

PROCEDURE	PAD ORDER	DISPLAY
1: Push in the switch button	 PRESS	00:00



2: Place probe in meat. Insert probe plug in receptacle in cavity wall.

3: Enter required temperature. Touch number 8 pad then number 5 pad	  PRESS Once Once	:85
4: Touch POWER LEVEL then number 7 pad	  PRESS Once Once	70
5: Touch the START pad	 PRESS Once	-34

NOTE: When temperature is lower than 34°C the display will show - 34°C with the probe indicator flashing.

When the food has reached the desired temperature of 85°C, the end of cooking signal will sound and the oven will automatically revert to a HOLD programme to maintain the food at exactly 85°C until required. (Display - HOLD).

NOTE: Although the temperature may be held indefinitely, it is recommended that the food is served as soon as possible. If the HOLD function is not required, proceed as follows:-

6: Touch the CANCEL pad and remove probe from receptacle	 PRESS Once	00:00
7: Press the switch button to revert to time of day	 PRESS	TIME OF DAY

To Check Programmed Temperature During Cooking

If you are in the process of cooking using the temperature probe and wish to check the temperature you have programmed, simply touch the probe pad. The final temperature will be displayed for 3 seconds.

Suppose you programmed temperature at 70°C on HIGH (100%) power.

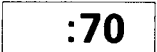
PROCEDURE	PAD ORDER	DISPLAY
1: Touch the temperature probe pad	 PRESS Once	

NOTE: After 3s, current temperature will reappear on the display.

Oven Shelf

Your new microwave oven includes a removable metal shelf to increase the capacity of the oven. The shelf is designed specifically for use in your oven and will not interfere with the correct distribution of microwaves. No other shelf should be used.

The shelf can be used in either of two positions. You should choose the position that suits the sizes of dishes being used. The shelf must be removed when it is not in use.

The shelf is used for

1. Cooking or reheating several items of food at one time in the oven.
2. Increasing the oven capacity so that complete oven meals can be cooked in a simple one or two step operation. See 'Planning and Cooking' for hints on how to benefit from your oven shelf.
3. The metal shelf should only be used when employing both cooking levels, or browning. On no account may it be used when microwave cooking on one level only.
4. The shelf will allow you to select the proper distance between the foods and the browner element.

NOTE: When browning and under some circumstances the metal shelf will become hot. Oven gloves should be used if the shelf is to be handled during or just after cooking.

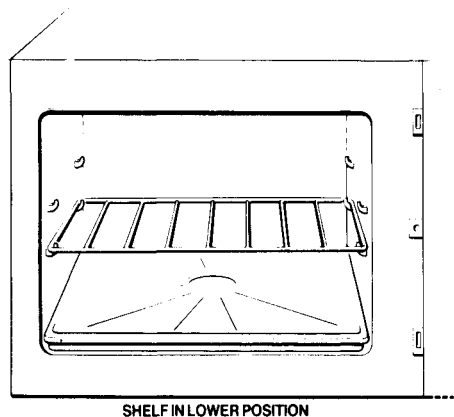
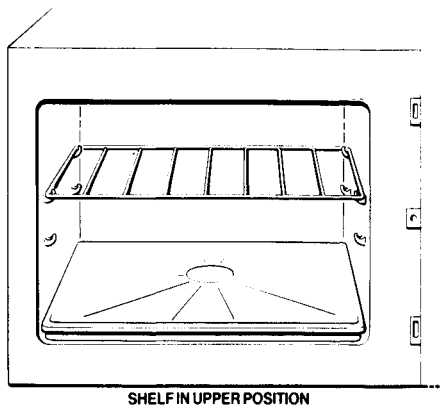

Planning and cooking

. . . multi foods and complete oven meals in the microwave oven

When cooking several food items or complete oven meals, the location of each item is important. When combining cooking of several dishes, those that require the longest cooking times are placed on the shelf whilst those requiring shorter cooking or heating times are placed on the glass tray. This is because the microwaves first start cooking the food at the top of the oven.

Remember that as the amount of food placed in the oven is increased the cooking times must also be increased.

Therefore, complete oven meals will require a longer cooking time than the cooking of one food item.

To get a general idea of how much time a complete meal will require, add up the amount of time required for each food, if

cooked separately, and this will be the approximate cooking time required. In most cases, the cooking of a complete meal at one time will not save significant cooking times. However, the convenience of being able to place all the food in the oven at the same time will make microwave cooking more convenient.

When planning oven meals, take into consideration the types of food and how quickly they cook in the oven. It may be necessary for you to check the food during cooking, removing some food ahead of time or allowing some food to cook for a longer period of time. In most cases you can place several items of food in the microwave oven at the same time.

However, some food that takes longer to cook should be put in the oven earlier, and faster cooking food, such as rolls should be put in the oven later in the cooking period.

Placing food directly over each other on the top and bottom shelves will slow down cooking of the food on the bottom glass tray.

Place small cups or dishes carefully on the shelf so they do not tip.

Questions and Answers

Q Does it harm the oven if it is accidentally operated with no food in it?

A Severe damage can occur if the oven is turned on when it is empty.

Q Is eating food cooked in a microwave oven harmful?

A Microwaves are simply a source of heat energy just like gas and electricity. All three produce cooking in the food itself. Therefore food cooked in a microwave oven is not harmful to eat.

Q Why do I have moisture in the microwave oven after cooking?

A The moisture on the inside of your microwave oven is normal and nothing to worry about. It is caused by the steam from the cooking food hitting a cool oven surface. Wipe excess moisture from the inside of the oven after each use.

Q What causes the oven interior light to dim when using Variable Power?

A This is normal and indicates that the oven is operating and cycling normally.

Q Foods cooked in a microwave oven seem to cool off faster than conventionally cooked foods. Why is that?

A Often the dish used to store foods in the refrigerator is then used for heating the food in the microwave oven. In this case, the cold dish absorbs heat from the food. It may be necessary to heat the food for an additional time.

If the oven does not turn on

★ Check that the appliance is connected correctly.

★ Check that the plug is firmly connected to the wall socket and that the socket is switched on. Check the power supply by plugging in another appliance.

★ Replace the fuse in the plug with another of the appropriate rating.

★ Check that the fuse in the fuse box is intact.

★ Ensure that you have pressed 'Start' to commence cooking, and that the door is firmly closed.

★ If the cooking results are not satisfactory, ensure that you have programmed the oven correctly.

★ Check that the food is not covered with excessive foil and you have not used a metal lid. Also check that the air vents are not obstructed.

★ If the oven light does not operate, check the fuse in the plug.

★ If after all these checks the appliance still does not work, call your local Zanussi Network Service Centre, the details of which can be found in your local telephone directory under 'Z'.

NEVER ATTEMPT TO REMOVE THE REAR PANEL OF THE OVEN OR TAMPER WITH THE OVEN IN ANY WAY.

★ Please note that it will be necessary to provide proof of purchase for any in-guarantee service calls.

Peace of mind for twelve months

Zanussi standard guarantee conditions

This guarantee is in addition to your statutory and other legal rights which will not be excluded or in any way diminished by the return of this guarantee card. We, Zanussi Limited, undertake that if, within twelve months of the date of the purchase, this ZANUSSI appliance or any part thereof is proved to be defective by reason only of faulty workmanship or materials, we will, at our option, repair or replace the same **FREE OF ANY CHARGE** for labour; materials or carriage on condition that:

- The appliance has been correctly installed and used only on the electricity supply stated on the rating plate.
- The appliance has been used for normal domestic purposes only, and in accordance with the manufacturer's operating and maintenance instructions.

- The appliance has not been serviced, maintained, repaired, taken apart or tampered with by any person not authorised by us.
- The appliance is still in the possession of the original purchaser.

All service work under this guarantee must be undertaken by a Zanussi Network Service Centre.

Any appliance or defective part replaced shall become our property.

Exclusions

This guarantee does not cover:

- Damage or calls resulting from transportation, improper use or neglect, the replacement of any light bulbs or removable parts of glass or plastic.
- Cost incurred for calls to put right machines improperly installed or calls to machines outside the UK and the Republic of Ireland.
- Appliances found to be in use within a commercial environment, plus those which are the subject of rental agreements.

Or five years

Zanussi 5 Year Cover Conditions (See enclosed leaflet)

For a once-only payment you can extend your Standard Guarantee, all the conditions and exclusions of which apply.

1. Products supplied as 'seconds', refurbished, damaged or shop-soiled are not eligible for Zanussi cover.
2. The issue of a cover does NOT by virtue of our having done so, nullify the exclusions.

3. The Engineer will need to check the details of your Cover card and will make a charge for his services if it is not presented to him at the time of his call.

4. The date of purchase, or the date of initial payment (deposit) of the appliance will be deemed the date of commencement of cover.

5. Covers issued are not refundable or transferable.

6. Change of address:
Zanussi Cover Card is valid throughout UK, including Isle of Man, Channel Islands, Northern Ireland and Republic of Ireland and does not require amending. Advice in writing, quoting the 'Cover' Card number is necessary to enable correction of our records.



ZANUSSI

The Appliance of Science

Free Manuals Download Website

<http://myh66.com>

<http://usermanuals.us>

<http://www.somanuals.com>

<http://www.4manuals.cc>

<http://www.manual-lib.com>

<http://www.404manual.com>

<http://www.luxmanual.com>

<http://aubethermostatmanual.com>

Golf course search by state

<http://golfingnear.com>

Email search by domain

<http://emailbydomain.com>

Auto manuals search

<http://auto.somanuals.com>

TV manuals search

<http://tv.somanuals.com>