

# INSTRUCTIONS FOR THE USE AND CARE OF ZANUSSI BUILT - IN OVEN

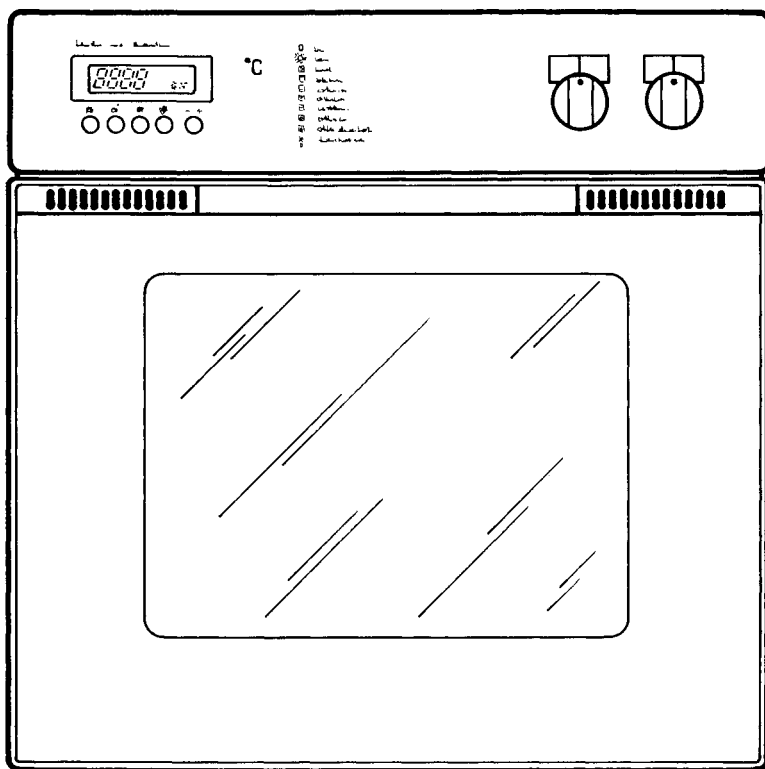

Model No. FM 5611  
FM 9611

**ZANUSSI**  
The appliance of science



# Warnings - Built-in ovens

**It is most important that this instruction book should be retained with the appliance for future reference. Should the appliance be sold or transferred to another owner, or should you move house and leave the appliance, always ensure that the book is supplied with the appliance in order that the new owner can be acquainted with the functioning of the appliance and the relevant warnings.**

**THESE WARNINGS ARE PROVIDED IN THE INTEREST OF SAFETY. YOU MUST READ THEM CAREFULLY BEFORE INSTALLING OR USING THE APPLIANCE.**

**This appliance is designed to be operated by adults. Children should not be allowed to tamper with the controls or play with the product.**

**Any installation work must be undertaken by a qualified electrician or competent person.**

**It is dangerous to alter the specifications or modify the product in any way.**

**This product should be serviced by an authorized Zanussi Network Service Centre, and only genuine Zanussi spare parts should be used.**

**Cookers become very hot with use, and retain their heat for a long period after use. Children should be supervised at all times and should not be allowed to touch the hot surfaces or be in the vicinity when in use or until the appliance has cooled after use.**

**Always ensure that the control knobs are in the «off» position when not in use.**

**For hygiene and safety reasons, this appliance should be kept clean at all times. A build-up of fats or foodstuffs could result in a fire.**

**This appliance has been designed for cooking edible foodstuffs only, and must not be used for any other purposes.**

**Never line any part of the oven with aluminium foil.**

**Easy clean liners should never be cleaned with any other than soapy water (see cleaning instructions).**

**Before any maintenance or cleaning work is carried out on the appliance, always turn off the isolator switch at the cooker point, and allow to cool.**

**Ensure that the anti-tip oven shelves are put in place in the correct way (see instructions).**

**Under no circumstances should you attempt to repair the appliance yourself. Repairs carried out by inexperienced persons may cause injury or serious malfunctioning. Refer to your local Zanussi Service Centre. Always insist on genuine Zanussi spare parts.**

# Contents

When the oven is first installed	Page 5
Use and care	Page 6
Using the oven	Page 7
Electronic programmer	Page 9
Cleaning	Page 12
What happens if something goes wrong	Page 16
Zanussi guarantee conditions	Page 17

**Important:** The installation of the oven and electricity connection must always be done by competent installers to standards and regulations currently in force.

# When the oven is first installed

Once the oven is installed it is important to remove the protective materials which were put on in the factory.

Remove from these parts the plastic film, then wipe with a cloth dipped in methylated spirit.

Switch the oven control to MAX and leave it to run empty for 30 minutes to burn off any other protective materials. This will also remove any unpleasant new smells.

The oven is evenly heated throughout. A fan in the back wall distributes heated air round the food during cooking so that everything cooks in approximately the same time regardless of where it is placed in the oven.

Foods of different types, provided they require the same cooking temperature can be cooked together and there is little possibility of flavour transference.

## Cooling fan

The cooling fan is designed to cool the walls and the components of the oven itself.

The fan switches on automatically when the oven control knob is turned on.

Warm air is blown out through the aperture near the oven door handle.

## Technical data

Model Number: FM 5611 - FM 9611

## Recess dimensions

Height	580 mm
Width	560-570 mm
Depth	550 mm
Oven capacity	1.9 cu.ft

## Internal oven dimensions

Height	32 cm
Width	42 cm
Depth	39 cm

## Oven ratings

Traditional system	2.0 kW
Convection system	2.5 kW
Convection fan	25 W
Grill element	2.0 kW
Double grill element	3.0 kW
Oven lamp	15 W
Cooling fan	25 W
Total rating	3.040 kW

# Use and care

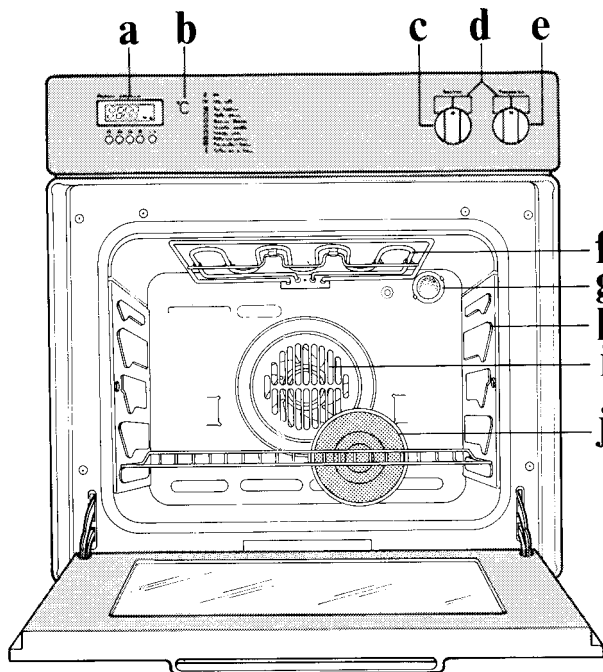

- a - Electronic/programmer
- b - Oven temperature light
- c - Oven control knob
- d - Dial
- e - Oven/grill temperature control knob
- f - Grill
- g - Interior light
- h - Removable oven liner panels
- i - Fan
- j - Removable grease filter

- k - Grill or roasting pan
- l - Reversible grill pan insert
- m - Removable handles (2 Off.)

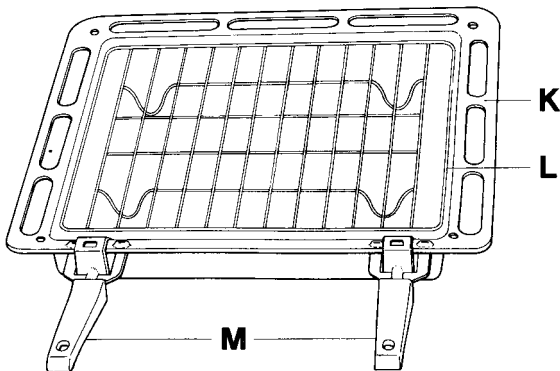

# Using the oven (Multifunction)

The multifunction oven makes it possible to carry out various types of cooking, depending on the nature of the food and its volume.

All cooking must be done with the oven door closed.

The oven light remains on with all cooking functions.

The oven control knob symbols are listed together with a brief description of the functions (a more detailed explanation of the functions and how to use them are given in the «Art of Cookery» book).

## Oven control knob (Fig. 1)

By turning this control knob, you can select any of the following functions:

- ☀ Oven light, this will come on whenever the oven is in use.
- ☐ Traditional cooking, uses the top and bottom element; this function will enable you to use your favourite recipes without having to adapt the

temperatures. It is necessary to pre-heat the oven in this instance.

- ☐ Top oven element only, enables you to finish off dishes on the top only.
- ☐ Bottom oven element only, enables you to finish off dishes on the bottom only.
- ☒ Inner grill element only for grilling small quantities.
- ☒ Inner and outer grill elements together for a full width grill.
- ☒ Ventilated grilling, gives a spit roast effect to all joints. Using this system eliminates the need to turn food during cooking, although large food items may require to be turned half way through the cooking time.
- ☒ Cuisinair cooking; this fan ducted system will allow you to roast or bake at the same time with very little flavour transference, and on any shelf. For this function the circular element and fan behind the back wall of the oven are used.
- ⊗ Defrost setting (N.B: This is NOT a cooking position). This position is intended to assist thawing of frozen foods.

Fig. 1

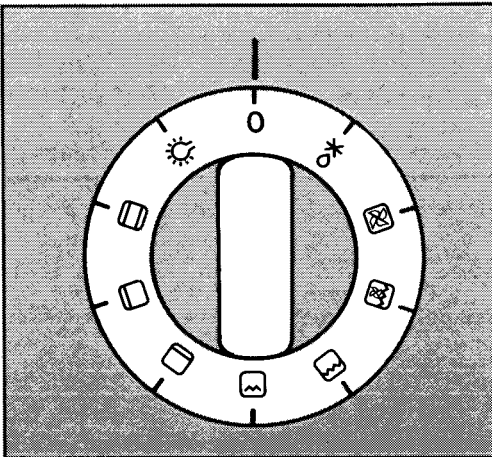

## Caution

Do not place pans, dripping pans, biscuit pans or aluminium foil on the oven bottom. This could cause a heath build-up which would affect the baking results and damage the oven enamel.

## Electric grill

To switch on the grill turn the oven control knob to (☐) or (☐) then turn the thermostat knob to the required temperature setting.

On this oven, the grill has two elements. In this case turning the oven control knob to (☐) symbol operates the inner element only, when the oven control knob is turned to (☐) symbol both the inner and outer elements operate. The result of the latter provides a larger grilling area. This is known as a dual element.

Foods to be grilled should be placed on the wire trivet in the grill pan. The trivet can be positioned either way up to give the required distance from the element.

### Caution

**The appliance must never be left unattended whilst grilling.**

Fig. 2

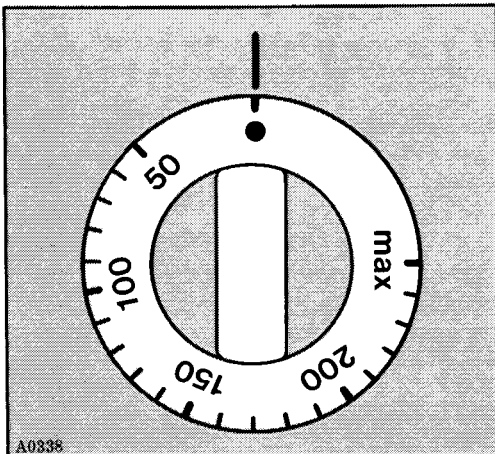

### Note:

We recommend that you wipe fat splashes off the grill element **when it is cold** in order to prevent smoking from the fat as it burns off when the grill is next used.

### Important

Your oven is fitted with hinges, giving two door positions, fully open or fully closed.

When grilling, the oven door must be closed.

Grilling with the door open could cause areas of the oven and surrounding furniture to become excessively hot as well as reducing the performance, efficiency and economy of the grill.

### Thermostat control knob (Fig. 2).

By turning the thermostat control knob clockwise you select the cooking temperature. Temperature selection starts at 50°C and is marked in 25°C increments up to maximum, where the temperature at the centre of the oven will reach approximately 250°C. The thermostat controlling the temperature is totally variable so it is possible to select temperatures between those marked. The MAX setting is particularly suitable for grilling. Once the oven temperature has been selected, the temperature light will come on and remain on until the oven has reached the correct setting; after that it will come on and off with the thermostat showing how the temperature is being maintained.



During cooking the oven door should be opened as little as possible to avoid heat loss and so excessive electricity consumption.





## Safety thermostat

Should the main oven thermostat fail, the oven is protected by a safety thermostat which will operate if the temperature within the oven reaches too high a level. Once the temperature has returned to a safe level the main oven thermostat will function.

In cases where there is a permanent failure it is necessary to contact the Zanussi Network Service Engineer.

## Electronic programmer (Fig. 3).

The programmer performs the following functions: presetting of cooking time when using the oven; displaying the correct time of the day.

Symbol	Reference	Function
	A	Setting of the minute minder and display. To stop the buzzer.
	B	Setting and visualizing of the cooking period.
	C	Setting and visualizing of the end time of the cooking period.
	D	Manual operation
	E	Setting of the times (forward/backward)

## Operation pilot lamps

The lighting up of a pilot lamp indicates that the relevant function is operating.







Pilot lamp	Reference	Control
	1	General functioning
	2	Programme functioning
		Manual operation
	3	Automatic functioning



Fig. 3



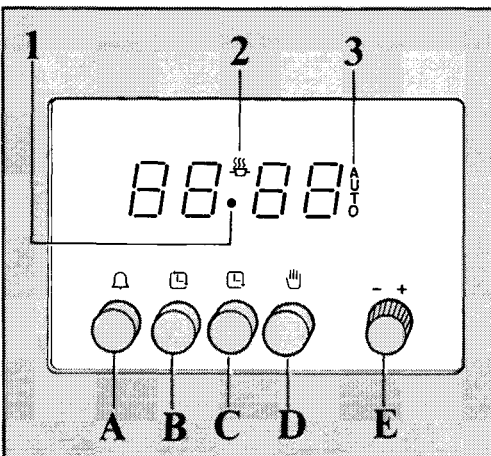



## Use

### Current time setting

The clock is preset to show the hours from 1 to 24 and the minutes from 0 to 60. When first connecting the appliance to the power supply, the numbers of the display and the pilot lamp  will flash indicating that the clock needs to be set. To enter the current time proceed as follows:

simultaneously depress pushbuttons  (A)  (B) and turn knob - + (E) as required until the correct hour and minutes are entered.



The electronic clock starts when you release pushbuttons  (A) and  (B) (pilot lamp  off and lamp  switched on).

For further resetting repeat the above sequence.

### Setting the minute minder with sound signal (buzzer)

The minute minder can be used only with the programmer set on manual operation (knob (D) depressed).

The maximum programmable time for the buzzer is 23 hrs. and 59 mins. Proceed as follows to set the minute minder:

depress knob (D) (pilot lamp  switches off and lamp  switches on);

depress pushbutton  (A) and at the same time turn knob - + (E) and set the desired time period.

Release pushbutton (A).







When the programmed time is up, the buzzer will ring for 2 minutes unless it is switched off by depressing pushbutton  (A).

**The minute minder, even though signaling other functions, will always buzz for a maximum of 2 minutes unless interrupted by depressing pushbutton  (A).**

### Semi-automatic operation of the oven

It is possible to start cooking immediately and to programme the period of the cooking process. The maximum programmable cooking period is of 23 hrs. and 59 mins.

Place the food to be cooked into the oven, turn the selector and thermostat knobs (Fig. 1 and 3) to the desired setting and proceed as follows:



depress pushbutton  (B) and, keeping it depressed, enter the required cooking period with knob - + (E); when you release pushbutton  (B) pilot lamps  and  will remain switched on indicating that the programme is operating. At the end of the cooking process the buzzer will ring. At the same time pilot lamp  switches off and pilot lamp  flashes; to switch it off depress pushbutton (D), lamp  switches on.





## Automatic operation of the oven

Cooking can be started and finished automatically.



The maximum programmable cooking period is of 23 hrs. and 59 mins.

Place the food to be cooked into the oven, turn the selector and thermostat knobs to the desired setting and proceed as follows:



depress pushbutton  (C) and, keeping it depressed, enter the required end time of the cooking period with knob - +; when you release pushbutton  (C) pilot lamp  will remain switched on indicating that the desired function has been set.

Depress pushbutton  (B) and, keeping it depressed, enter the required cooking period with knob - + (E); when you release pushbutton  (B) pilot lamp  will remain switched on and lamp  switches off indicating that the programme is operating.

When the cooking starts pilot lamp  switches on, at the end of the cooking period the buzzer will ring.

When the buzzer stops pilot lamp  switches off. At the same time pilot lamp  flashes; to switch it off depress pushbutton (D) (lamp  switches on).

## Manual (non-automatic) operation of the oven

The oven may be operated manually i.e. without programming. In this case it is necessary to depress pushbutton (D) (pilot lamp  switches off and lamp  switches on).

## Power cuts

In case of a power cut all data stored in the programmer are cancelled (i.e. current time, presetting and operating programmes).

When power is restored, the display starts flashing (digits on zero) indicating that it needs to be set.

# Cleaning the oven

## Grease filter

When roasting meat, be sure to install the special grease filter to protect the fan in the rear wall of the oven from fat splashes. After roasting is completed, remove the grease filter and clean thoroughly with warm soapy water. As it is stainless steel you can safely wash it in the dishwasher.

To remove the grease filter, pull up the protruding tongue and then pull the filter outwards removing it from the rear panel (Fig. 4).

## Glass door

This should be cleaned with a soft cloth soaked in warm detergent water. Do not use abrasive scourers or steel wool.

Fig. 4

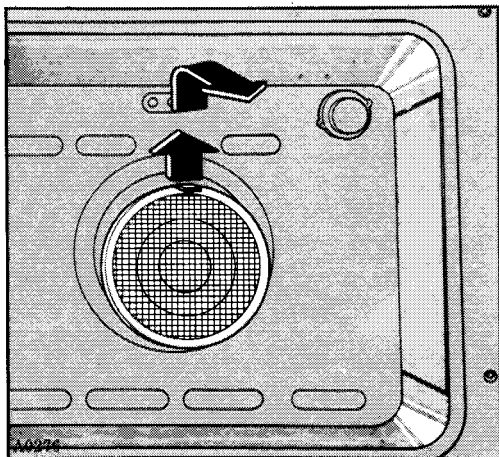

## Shelves

To clean the chrome parts of the oven, soak in warm detergent water and remove stubborn marks with a well wetted soap impregnated pad. Rinse well and dry with a soft cloth. Do not use abrasive scourers or steel wool.

## Special oven linings

This oven is fitted with a set of coated liners. These are known as «stay clean» or «easy care».

To obtain the maximum efficiency from your liners follow the guide lines carefully for their use and care.

The linings are coated with a special substance which helps to clean itself by a process of oxidization. Although the linings will not remain absolutely spotless they will reduce your oven cleaning chores considerably when used in the correct way.

The linings work most effectively if the splashes are kept to a minimum, and the soil is not allowed to build up, as this will retard the cleaning action. If the oven has been used at low temperatures it is advisable to wipe the soiled linings and oven interior with a soapy cloth. The linings should be rinsed with a clean cloth and then the oven should be heated for one hour on 200°C. Never use abrasive wools or pads or an aerosol oven cleaner on the coated linings.

## Oven cavity

The enamelled oven cavity is best cleaned whilst the oven is still warm. The oven linings can be removed for a more thorough cleaning of the oven interior. To do this remove the side panels after sliding them out of their retaining pins (Fig. 5).

**Before removing the back panel the oven must be disconnected from the electricity supply.**

To remove the back panel use a screwdriver (Fig. 6).

It is preferable/advisable to wipe the oven over with a soft cloth soaked in warm detergent water after each use. However, from time to time it will be necessary to do a more thorough cleaning, using a proprietary oven cleaner. Do not use aerosol oven cleaners, abrasive scourers or steel wool.

If the panels become very soiled, use a standard caustic product specially made for cleaning ovens.

Fig. 5

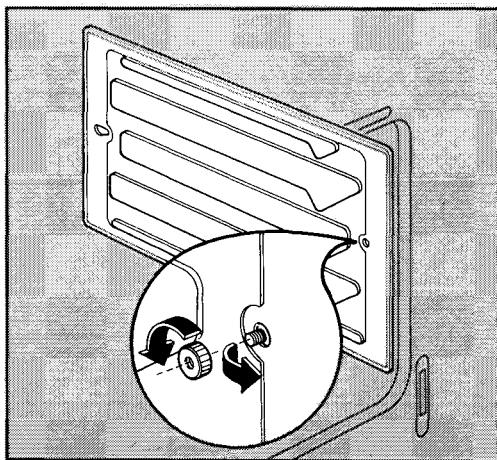
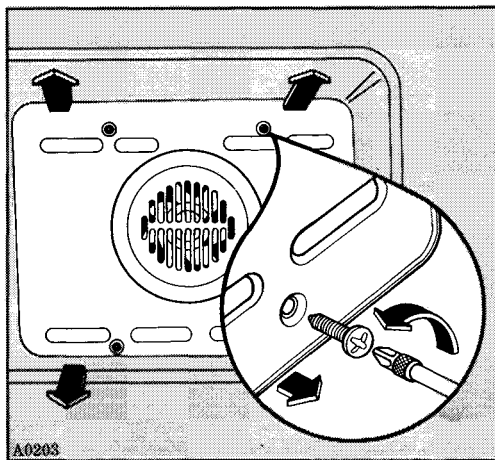

Fig. 6



## Replacing appliance components

Prior to undertaking any maintenance work or replacing the oven lamp or grill heating element, be sure to disconnect the appliance from the electricity supply.

### Oven lamp replacement

Push in and unscrew anticlockwise the glass cap (fig. 7). Remove the faulty bulb and replace with one that resists to high temperatures (300°C). Electric bulb: 15W, 240V, 50Hz, 300°C, E14. Bulbs are available from your Zanussi Service Network.

## Removing the oven door

1. Open the oven door so that it is in the horizontal position.
2. With the aid of a coin move the two retaining discs a quarter turn clockwise, so that the two raised bars are to the left hand side of the hinges (Fig. 8).
3. Raise the door halfway (Fig. 9).
4. At this stage the two hinges on either side of the door must be clasped together simultaneously. The door can then be removed by pulling out and downwards, maintaining the angle (Fig. 10).

Fig. 7

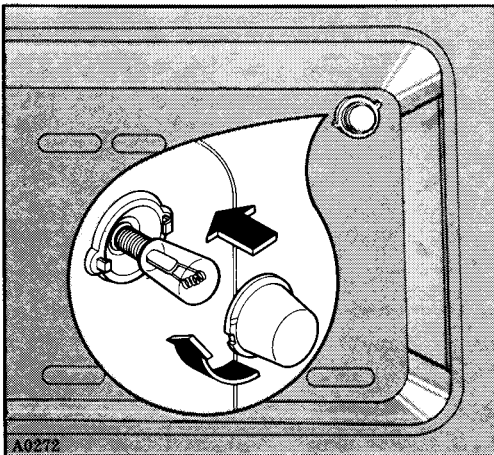
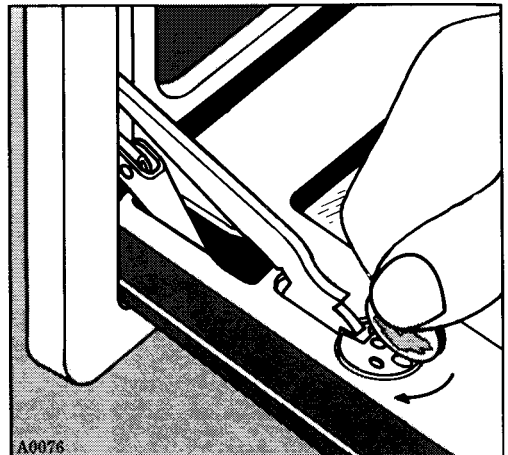

Fig. 8



### To replace the door

1. Clasp the two hinges on either side of the door together simultaneously.
2. Hook the top hinge into the top slot so that the hook is engaged with the roller.
3. Drop the lower hinge into the lower slot, so that the notch is engaged. Drop the door down so it is in the horizontal position.

**Note:** It is very important when carrying out this operation that both hinges should be located simultaneously.

4. Turn the retaining discs back a quarter turn so that the two raised bars are opposite the hinges. The door can then be closed.

Fig. 9

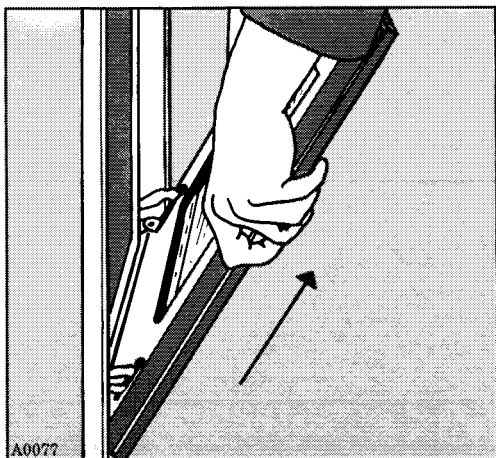
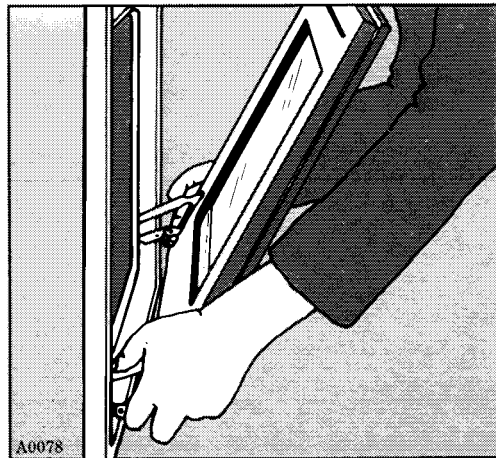



Fig. 10



# What happens if something goes wrong

If the oven does not come on when cooking manually, first check that the programmer is set for manual, ie. in the (  ) position.

If this is as it should be and the oven still does not come on:

- a) Check that it is plugged in properly.
- b) Check that the socket switch and/or switch from the supply to the oven are ON.
- c) Replace the fuse in the plug, when present, with another of the appropriate rating and check that this plug has been wired up properly.
- d) Check that the socket, when present, is supplying power - do this by plugging in another appliance that is known to be working properly.
- e) Check that the fuse in the fuse box is intact.

If, after all these checks, the oven still does not work, send for your local Zanussi network service centre listed in the telephone directory, under «Z».

It helps to jot down the name and address and telephone number in the space below.

---

Name

---

Address

---

Telephone number

---

**IN-GUARANTEE CUSTOMERS SHOULD ENSURE THAT THE ABOVE CHECKS HAVE BEEN MADE AS THE ENGINEER WILL MAKE A CHARGE IF THE FAULT IS NOT A MECHANICAL OR ELECTRICAL BREAKDOWN.**

Please note that it will be necessary to provide proof of purchase for any in-guarantee service calls.



# Peace of mind for twelve months

## **ZANUSSI STANDARD GUARANTEE CONDITIONS**

This guarantee is in addition to your statutory and other legal rights which will not be excluded or in any way diminished by the return of this guarantee card.

We, Zanussi Ltd., undertake that if, within twelve months of the date of the purchase, this ZANUSSI appliance or any part thereof is proved to be defective by reason only of faulty workmanship or materials, we will, at our option, repair or replace the same **FREE OF ANY CHARGE** for labour, materials or carriage on condition that:

- The appliance has been correctly installed and used only on the electricity supply stated on the rating plate.
- The appliance has been used for normal domestic purposes only, and in accordance with the manufacturer's operating and maintenance instructions.
- The appliance has not been serviced, maintained, repaired, taken apart or tampered with by any person not authorised by us.
- The appliance is still in the possession of the original purchaser.

All service work under this guarantee must be undertaken by a Zanussi Service Force Centre.

Any appliance or defective part replaced shall become our property.

## **Exclusions**

### **This guarantee does not cover:**

- Damage or calls resulting from transportation, improper use or neglect, the replacement of any light bulbs or removable parts of glass or plastic.
- Costs incurred for calls to put right machines improperly installed or calls to machines outside the United Kingdom.
- Appliances found to be in use within a commercial environment, plus those which are the subject of rental agreements.
- Products of Zanussi manufacture which are **NOT** marketed by Zanussi Ltd.
- EEC Countries - the standard guarantee is applicable but is subject to the owner's responsibility and cost to ensure the appliance meets the standards set by the country to which the product is taken. The Zanussi company in the country concerned will be pleased to advise further. Sight of your purchase receipt will be required by them.

# or five years

## ZANUSSI 5 YEAR COVER CONDITIONS

For a once-only payment you can extend your Standard Guarantee to 5 years. All the conditions and exclusions of the Standard Guarantee apply.

### Notes

1. Products supplied as "seconds", refurbished, damaged or shop-soiled are not eligible for Zanussi 5 Year Cover.
2. The issue of a cover does NOT by virtue of our having done so, nullify the exclusions.

3. The Engineer will need to check the details of your Cover card and may make a charge for his services if it is not presented to him at the time of his call.

4. The date of purchase, or the date of initial payment (deposit) of the appliance will be deemed the date of commencement of cover.

5. Covers issued are not refundable or transferable.

---

## Guarantee Record

Appliance purchased from \_\_\_\_\_ on \_\_\_\_\_  
Guarantee card no \_\_\_\_\_ Model no \_\_\_\_\_  
Serial no \_\_\_\_\_ (These details may be  
Your name \_\_\_\_\_ taken from your  
Address \_\_\_\_\_ Guarantee Record Card)

---



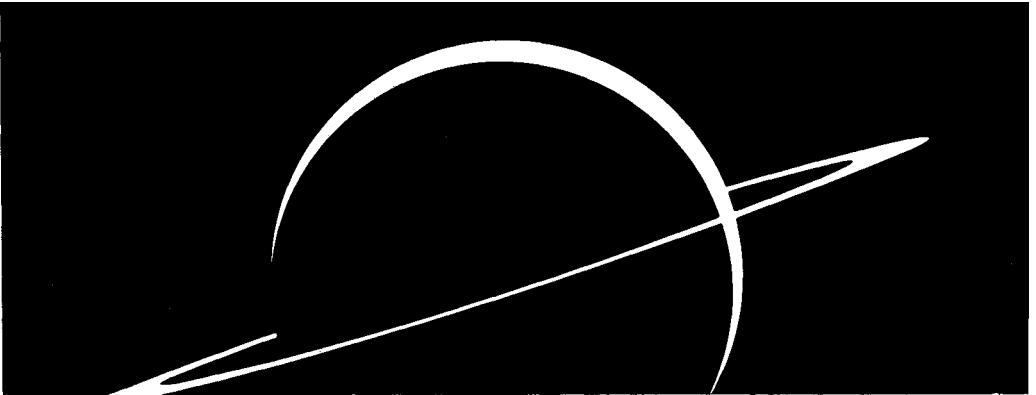

# ZANUSSI

The appliance of science

Zanussi Ltd., Zanussi House, Newbury.

The information in this manual is correct at time of going to press  
Zanussi reserve the right to alter specifications without notice.

## Free Manuals Download Website

<http://myh66.com>

<http://usermanuals.us>

<http://www.somanuals.com>

<http://www.4manuals.cc>

<http://www.manual-lib.com>

<http://www.404manual.com>

<http://www.luxmanual.com>

<http://aubethermostatmanual.com>

Golf course search by state

<http://golfingnear.com>

Email search by domain

<http://emailbydomain.com>

Auto manuals search

<http://auto.somanuals.com>

TV manuals search

<http://tv.somanuals.com>