

Zebra[®]

ZXP Series 8



**Card
Printer
Solutions**

© 2009, ZIH Corp.

1

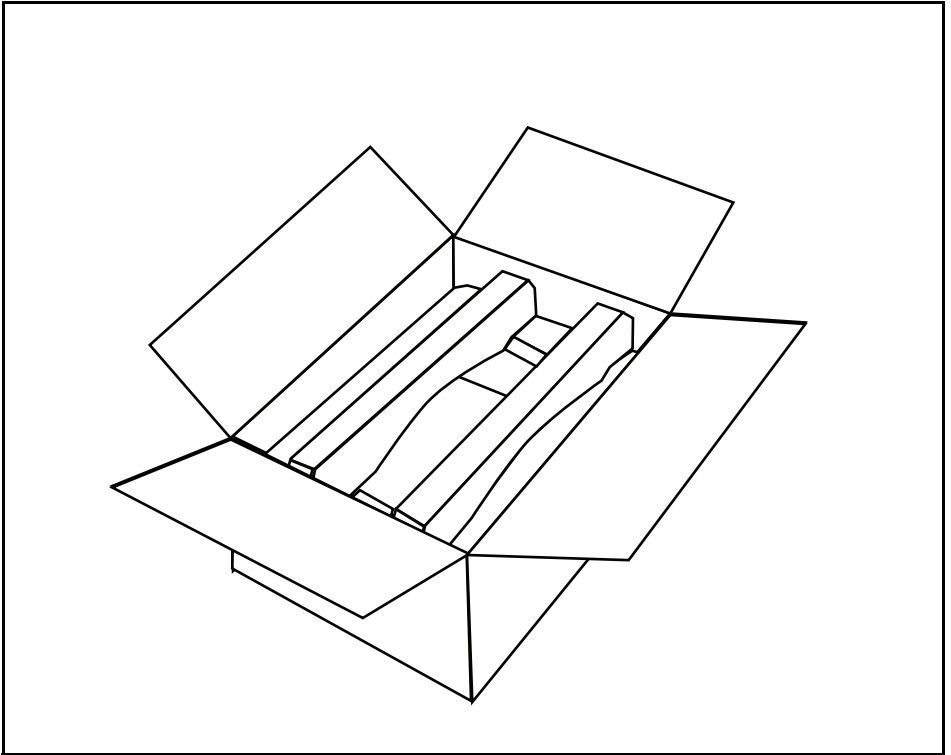
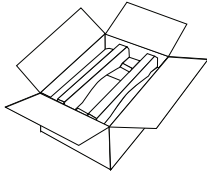

FCC - DECLARATION OF CONFORMITY

Model ZXP Series 8 has been tested and found to comply with the limits for a Class A device, pursuant to Part 15 of the FCC Rules. These limits are designed to provide reasonable protection against harmful interference when the equipment is operated in a commercial environment. This equipment generates, uses, and can radiate radio frequency energy and, if not installed and operated in accordance with the Model ZXP Series 8 User's Manual, may cause harmful interference to radio communications. Operation of this equipment in a residential area is likely to cause harmful interference, in which case the user will be required to correct the interference at his own expense.

Pursuant to Part 15.21 of the FCC Rules, any changes or modifications to this equipment not expressly approved by Zebra may cause harmful interference and void the FCC authorization to operate this equipment.

INDUSTRY CANADA NOTICE:

This device complies with Industry Canada ICES-003 class A requirements.

Cet équipement est conforme à l'ICES-003 classe A de la Norme Industrielle Canadienne.

2

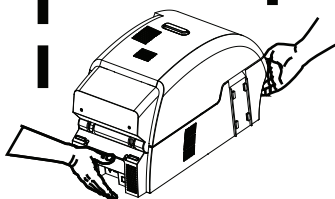
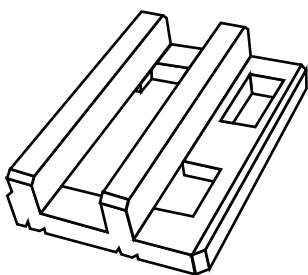
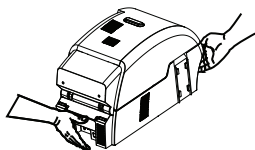

**27.5 lbs
(12.5 kg)**

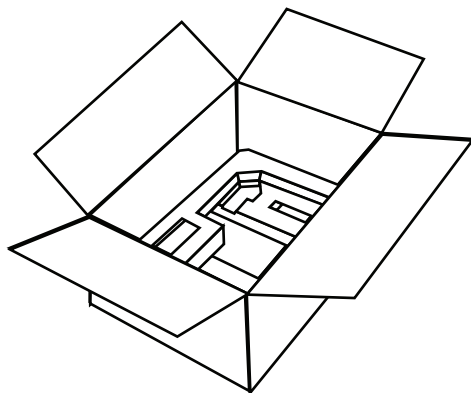

3

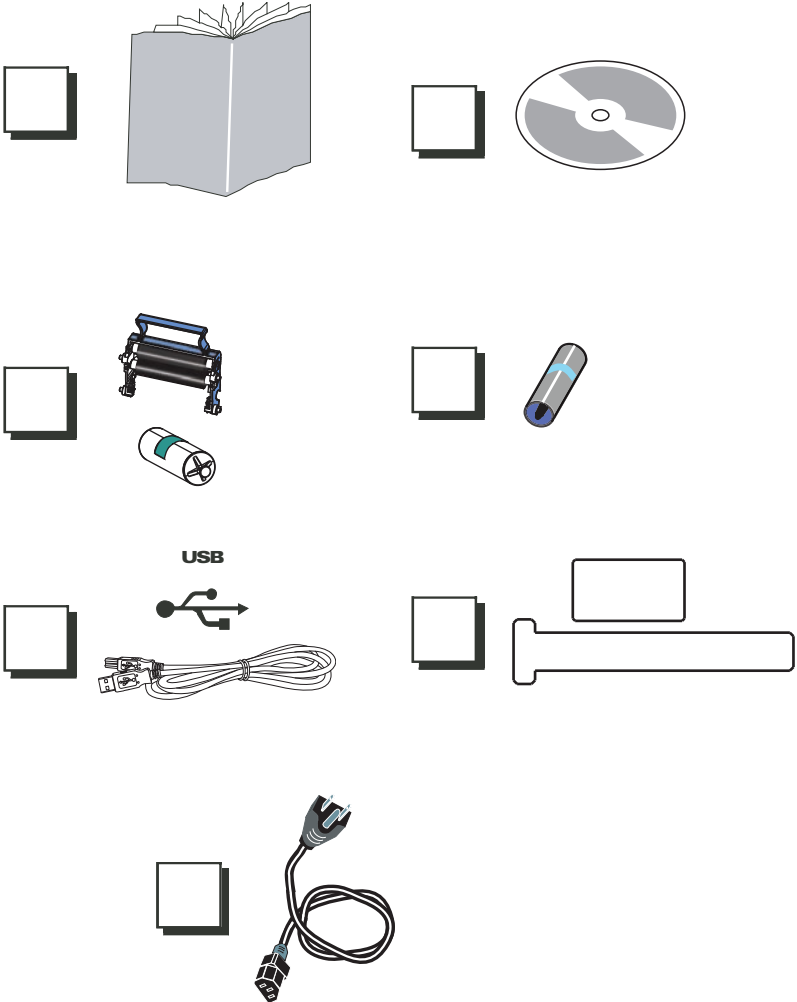
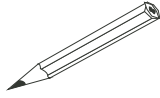

4

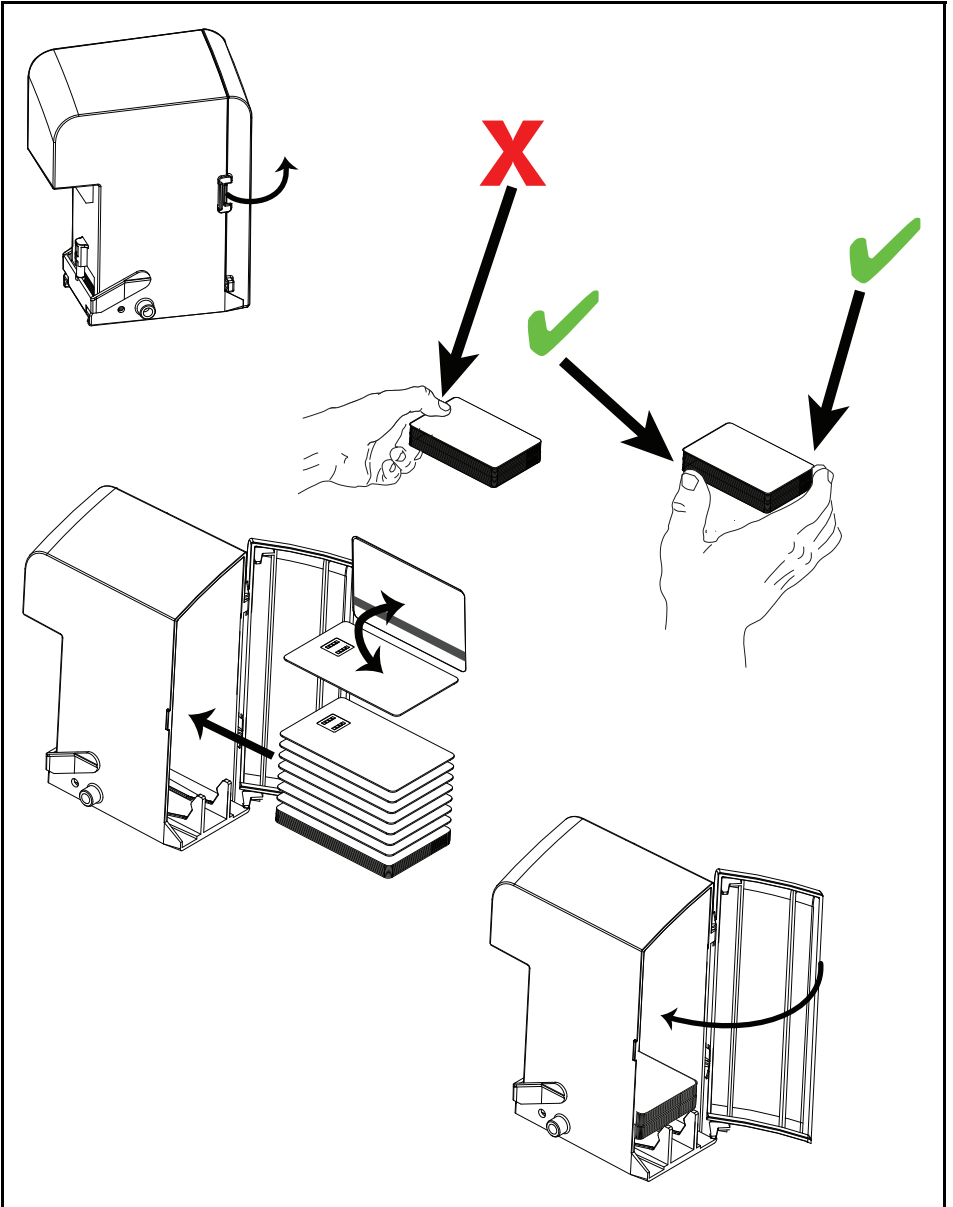
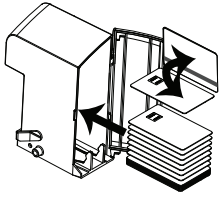

5

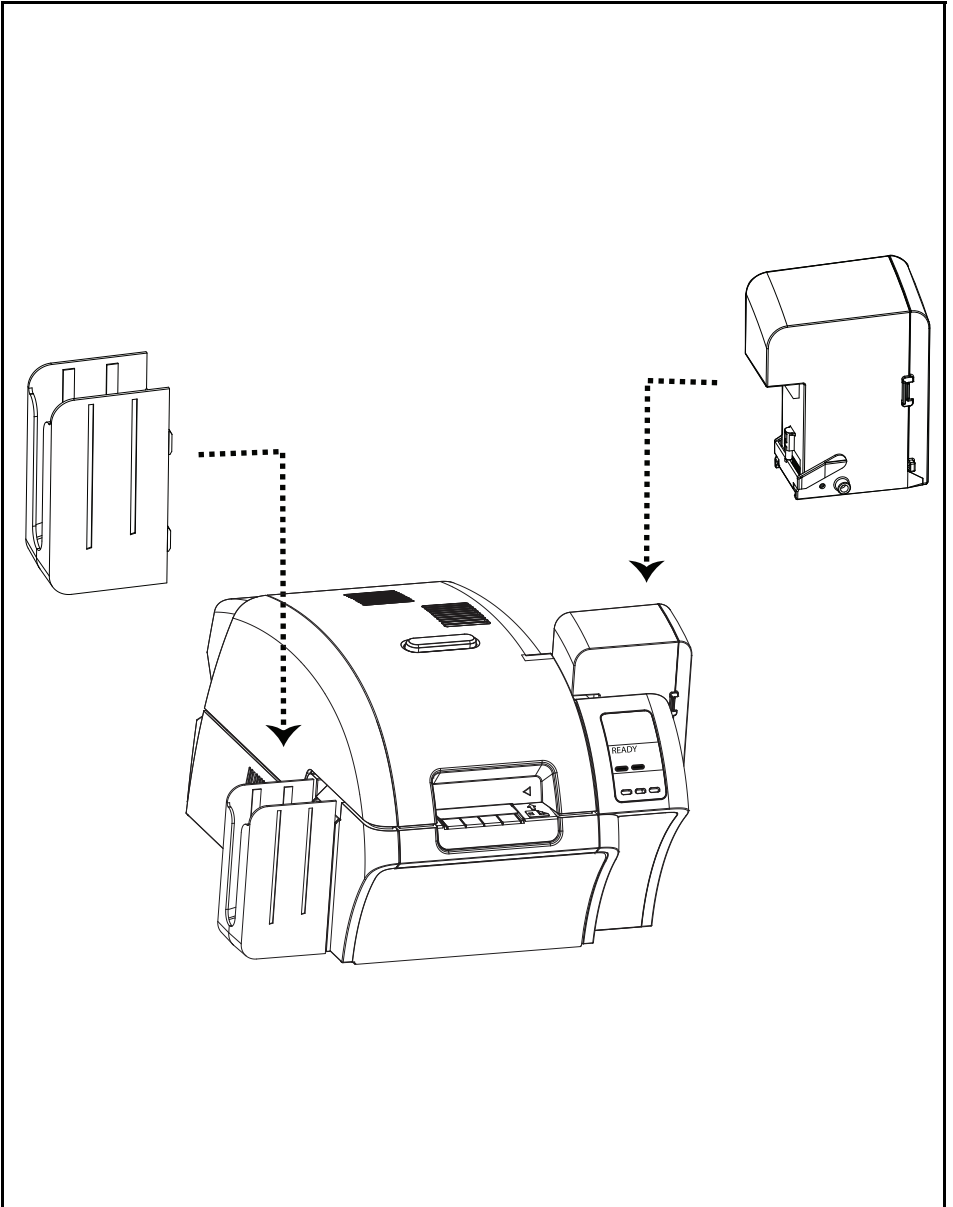
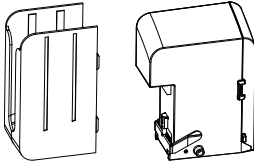

6

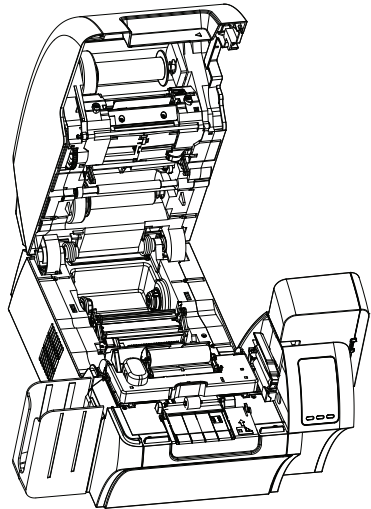
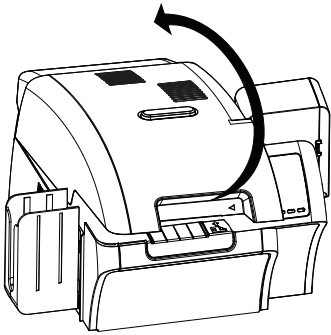
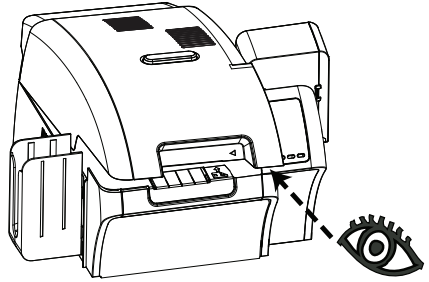
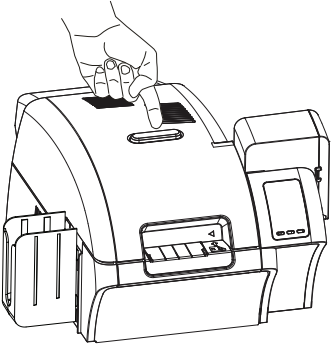
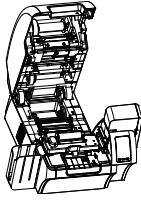

7

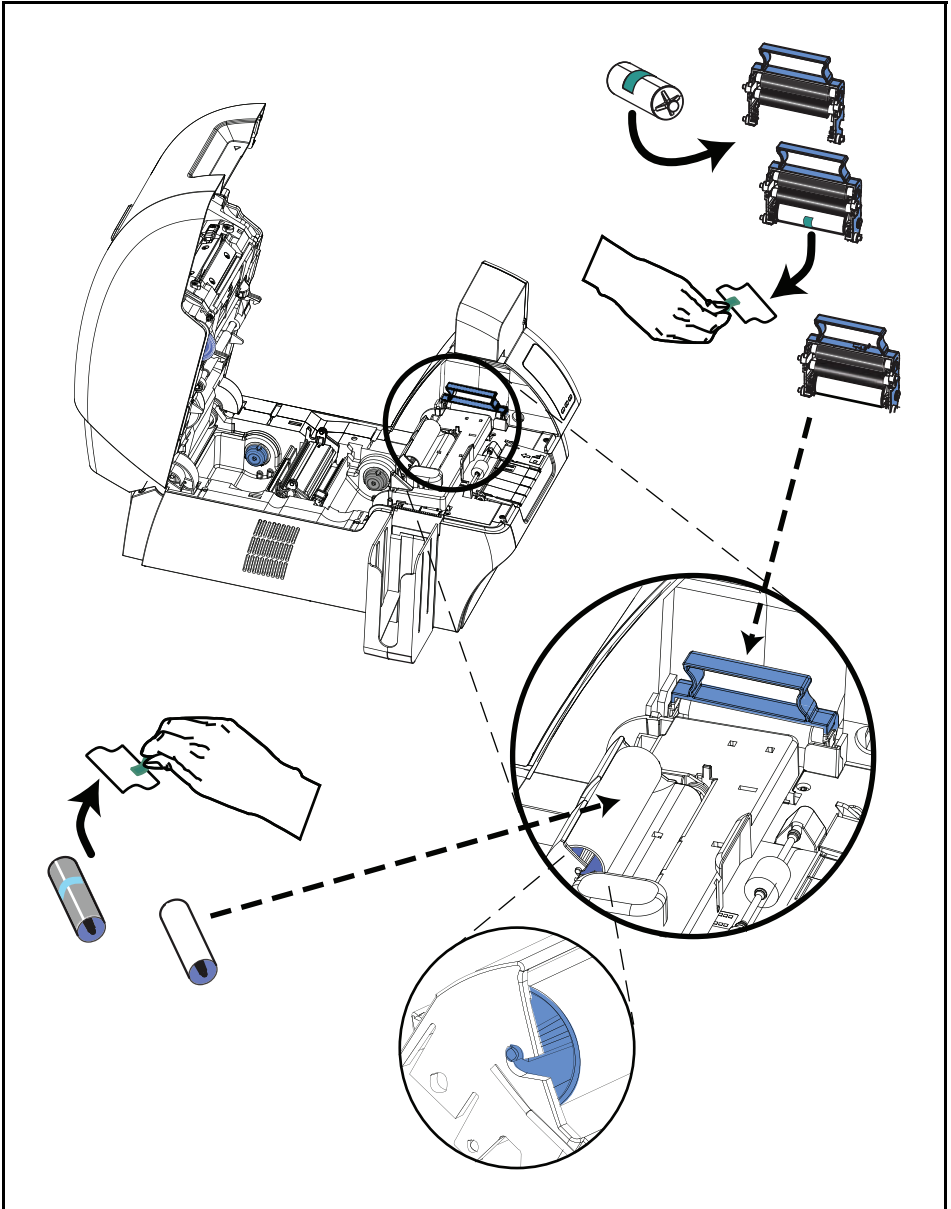
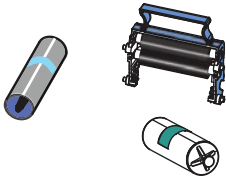

8

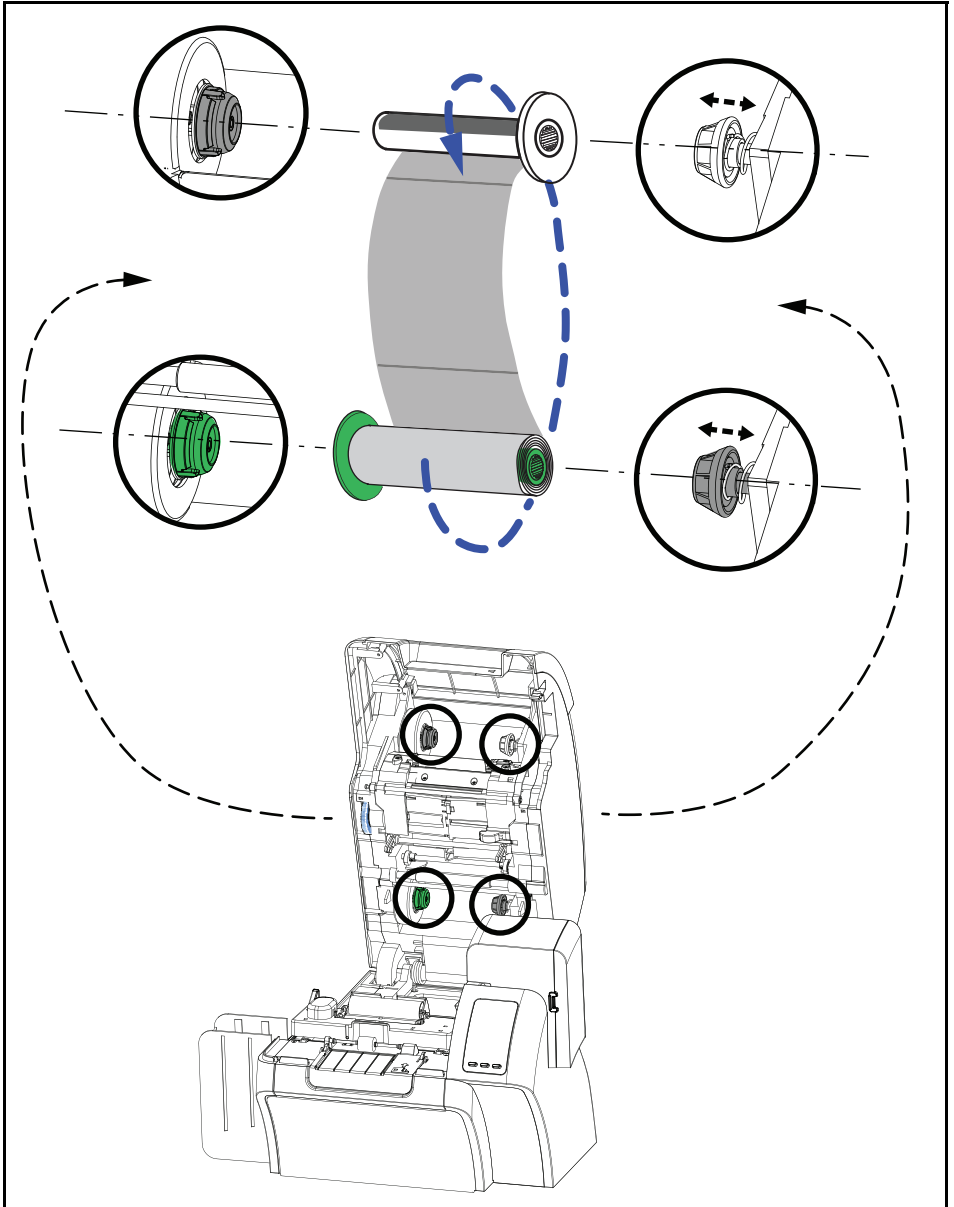
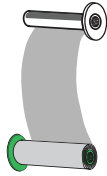

9

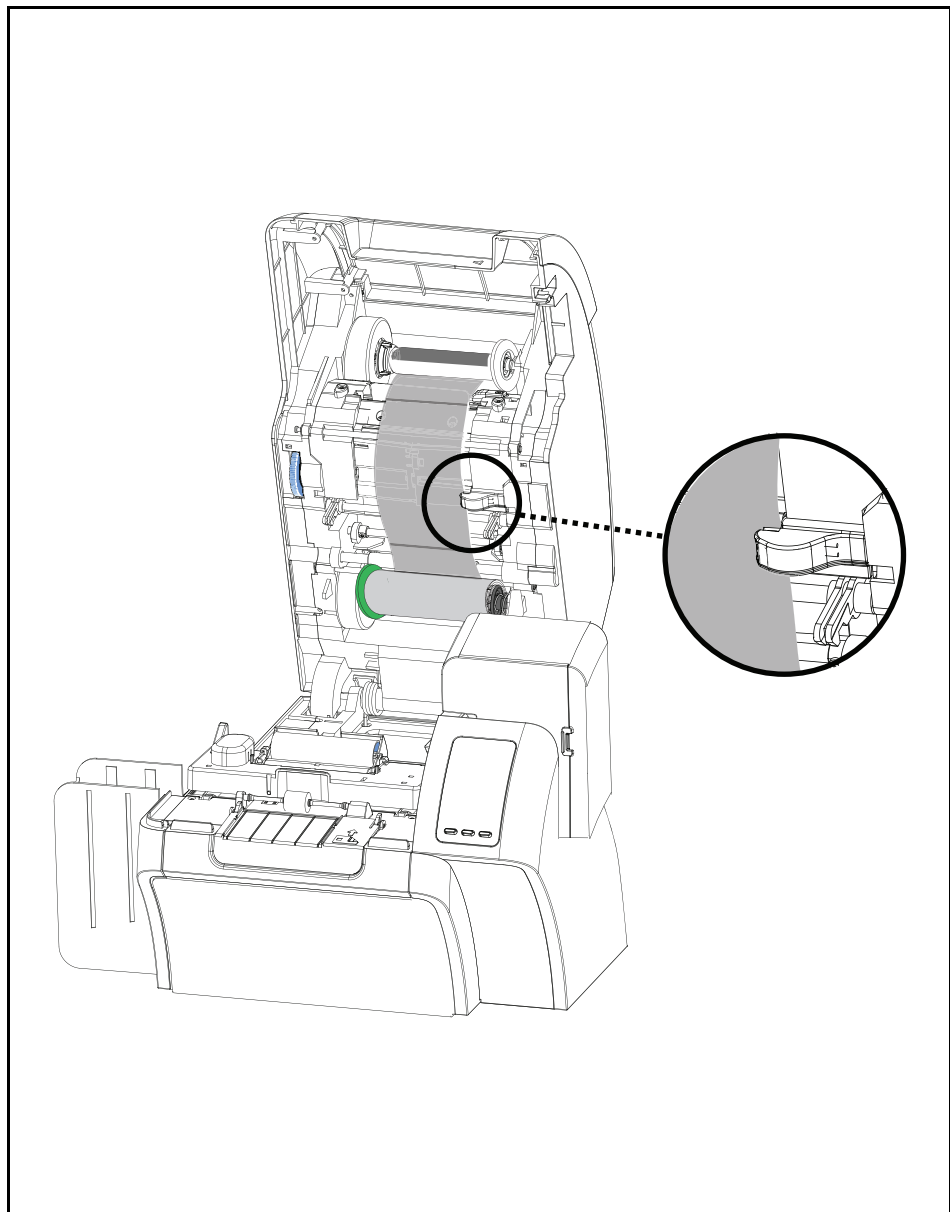
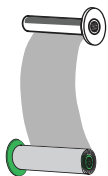

10

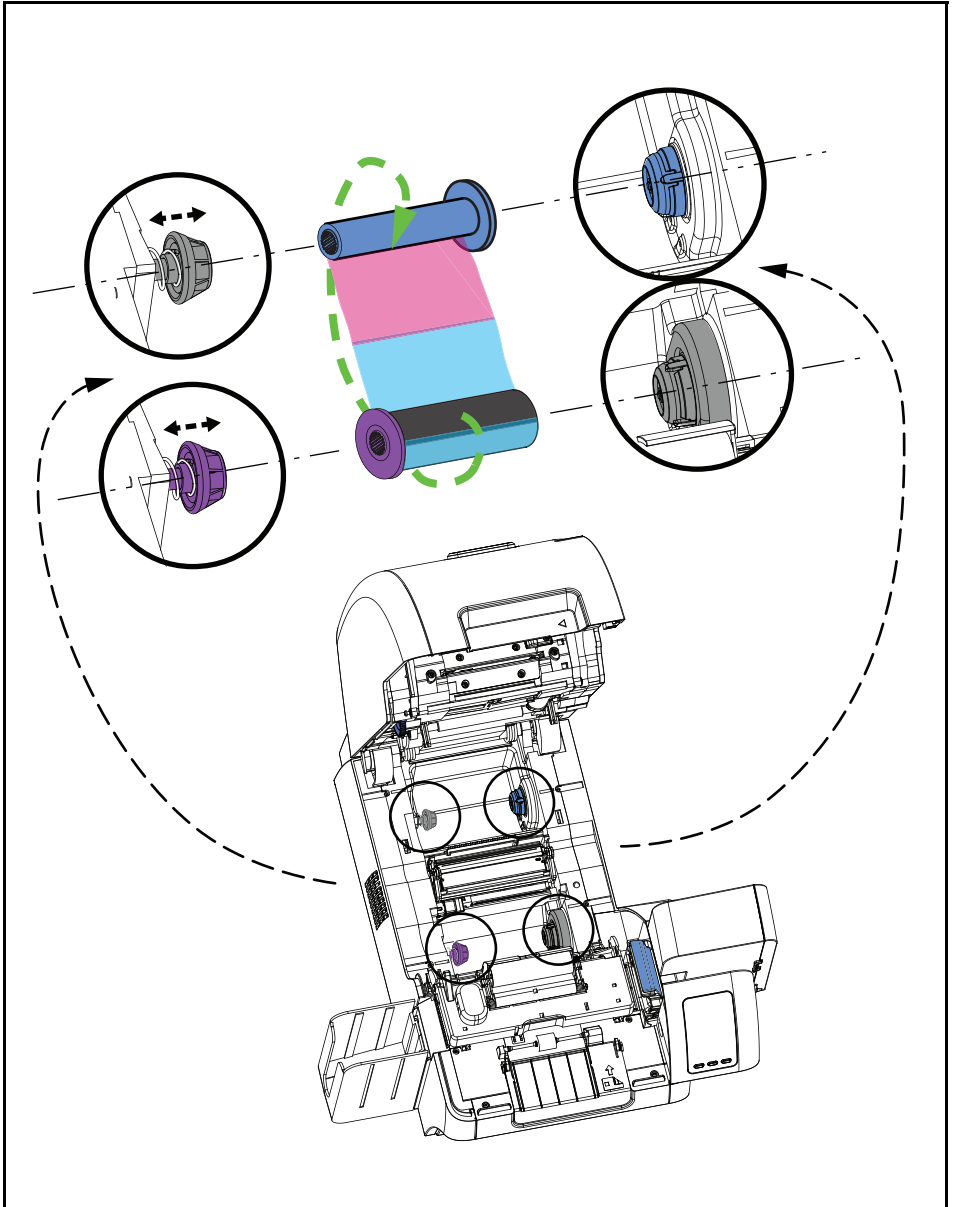
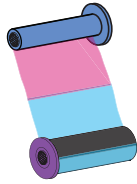

11

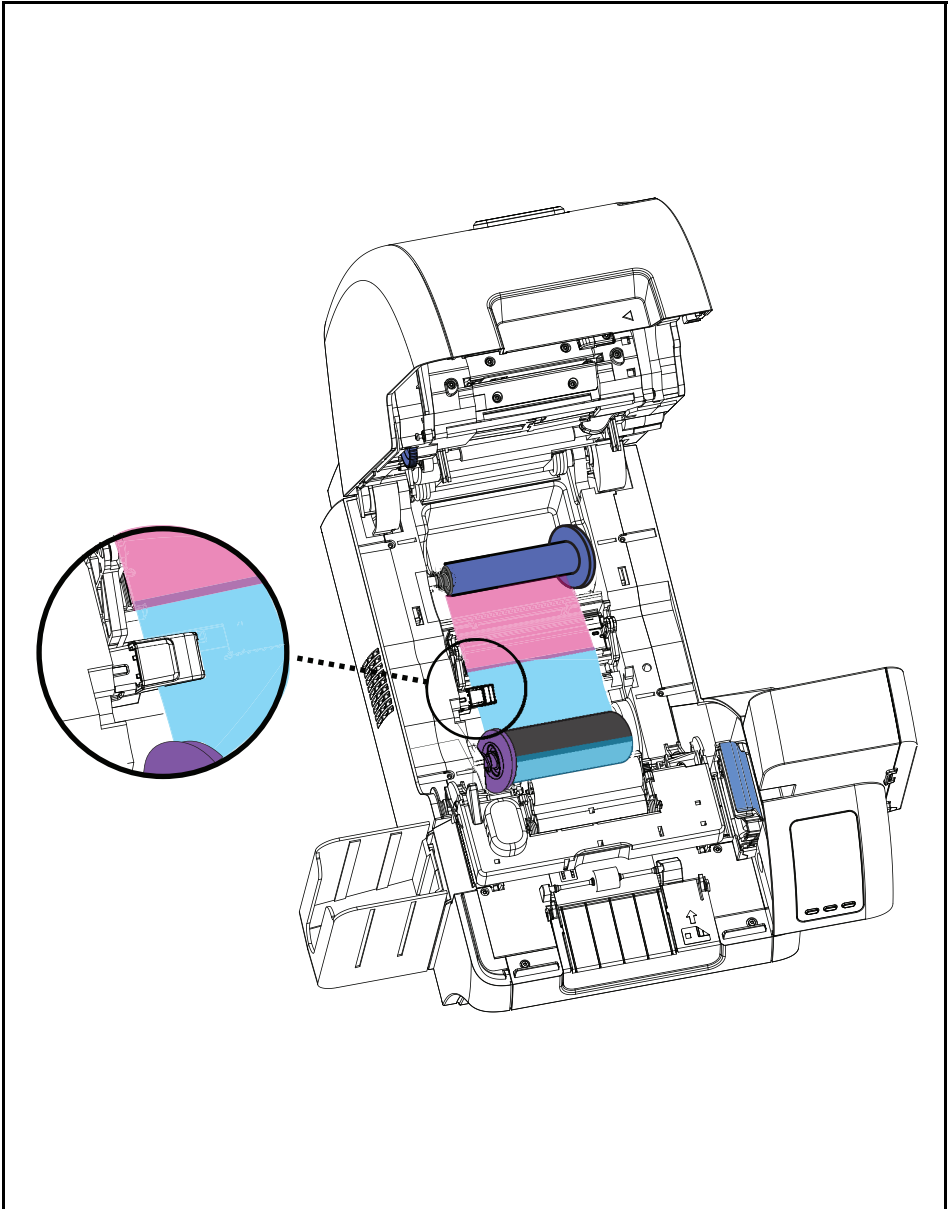
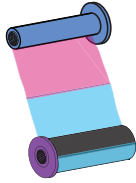

12

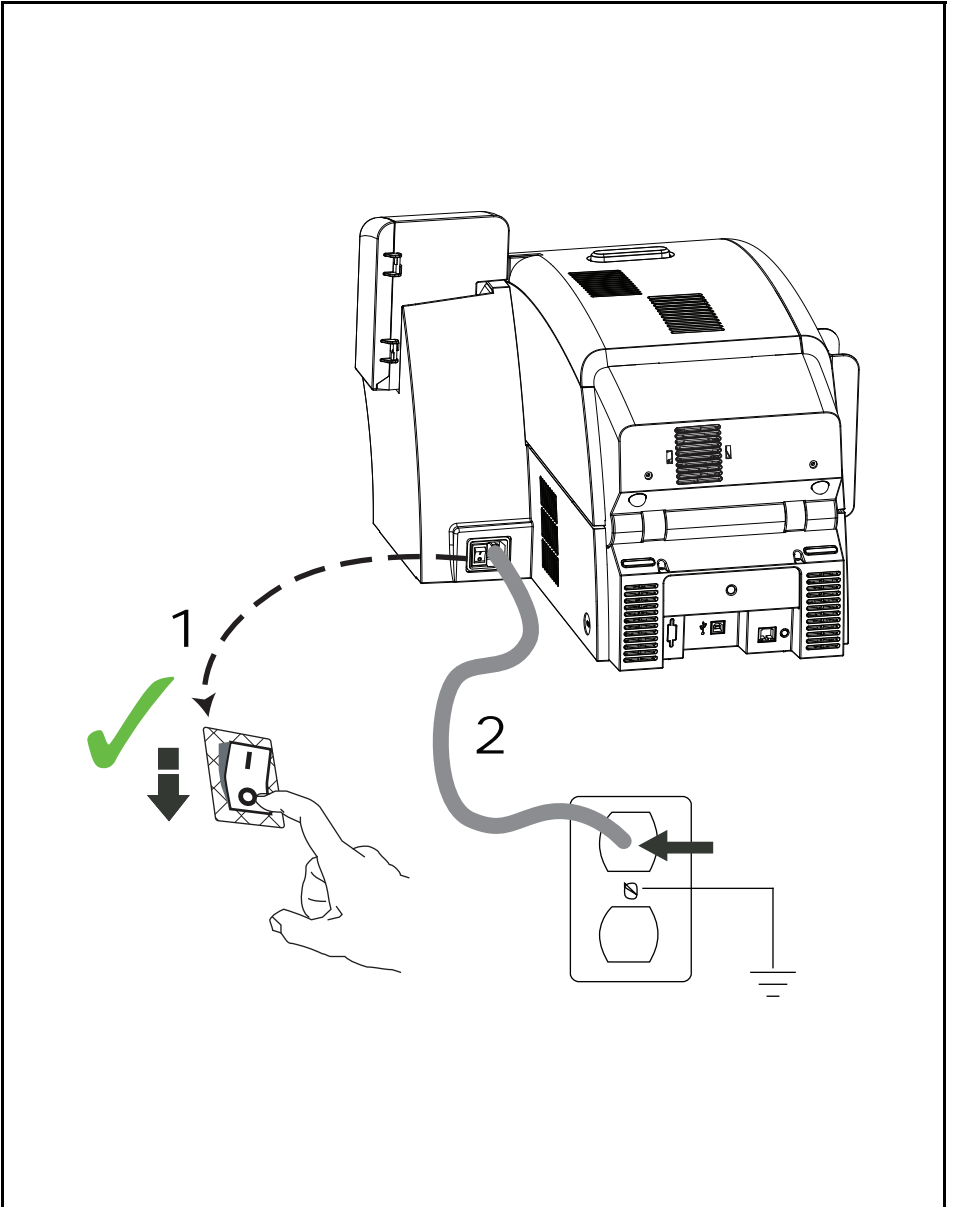
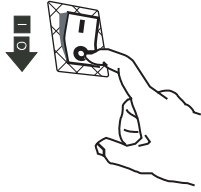

13

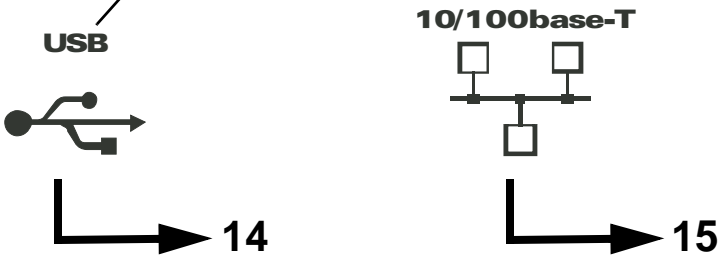
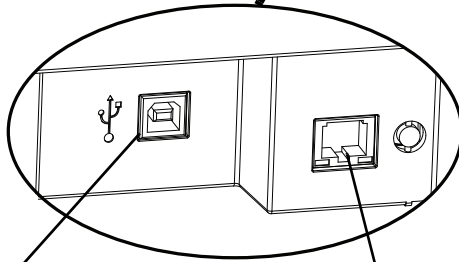
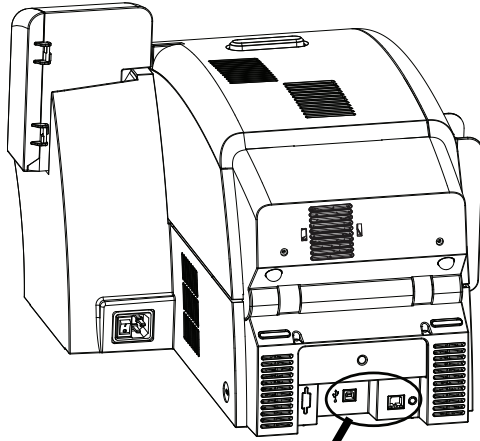
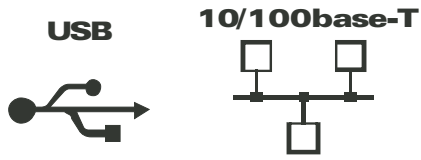

14

USB

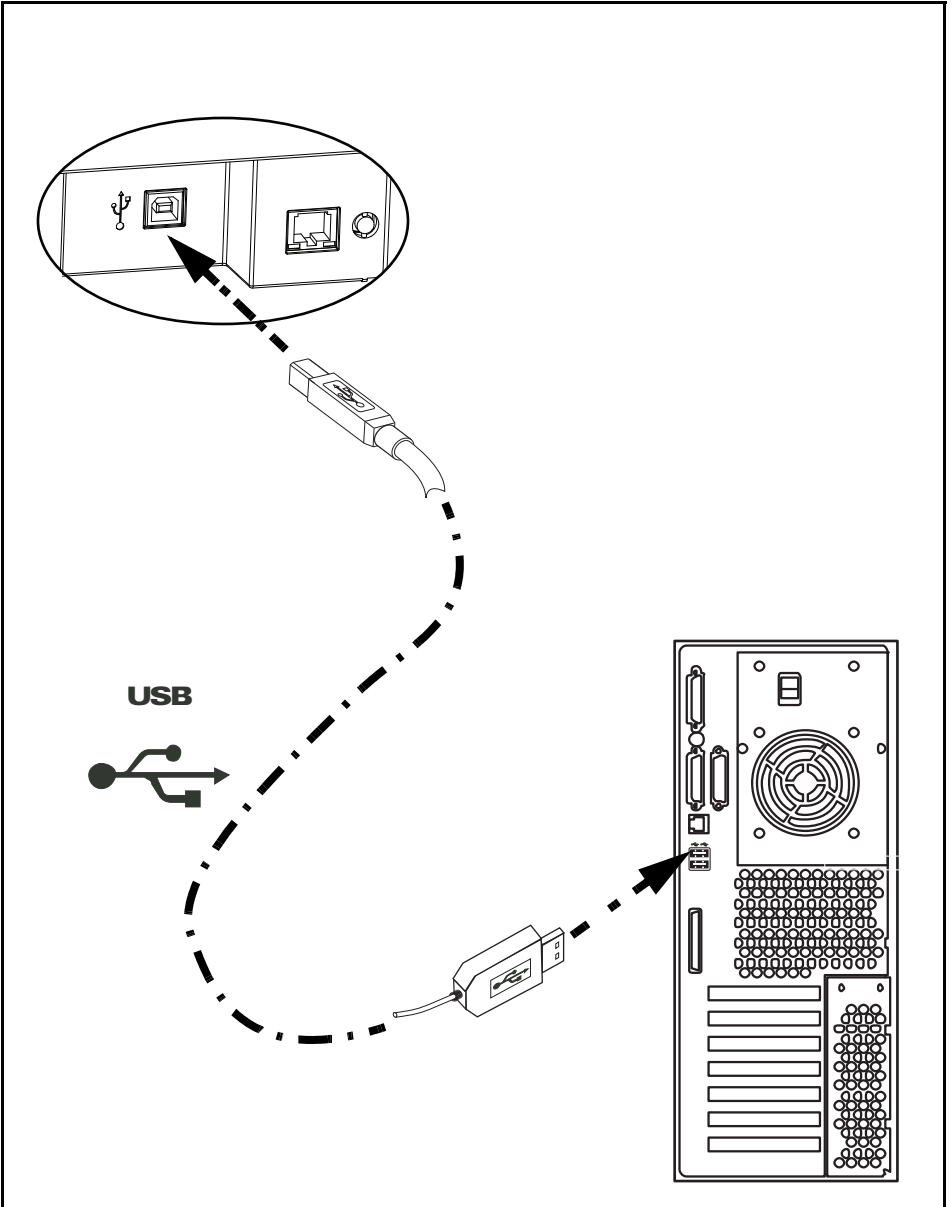

15

10/100base-T

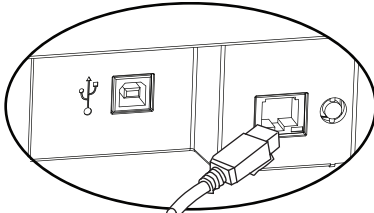
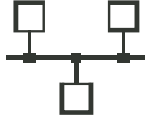

10/100base-T

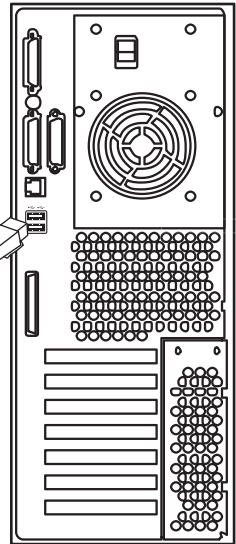
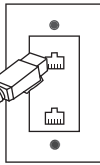
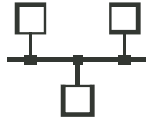

10/100base-T

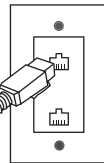
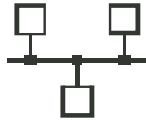

16

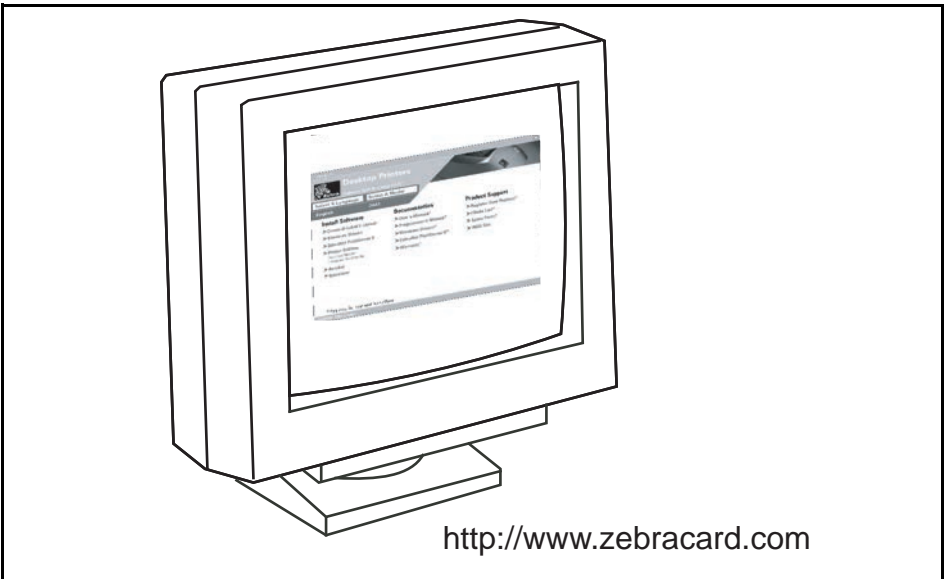
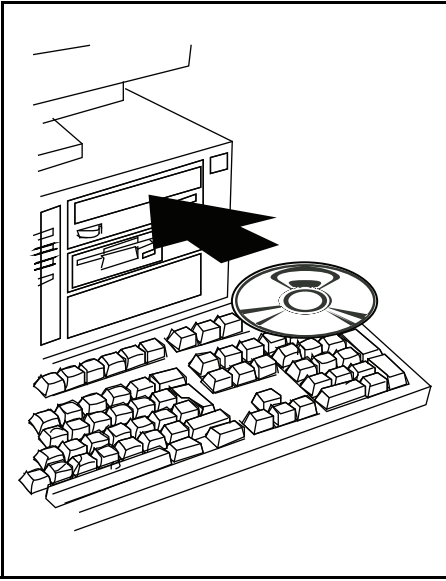

17

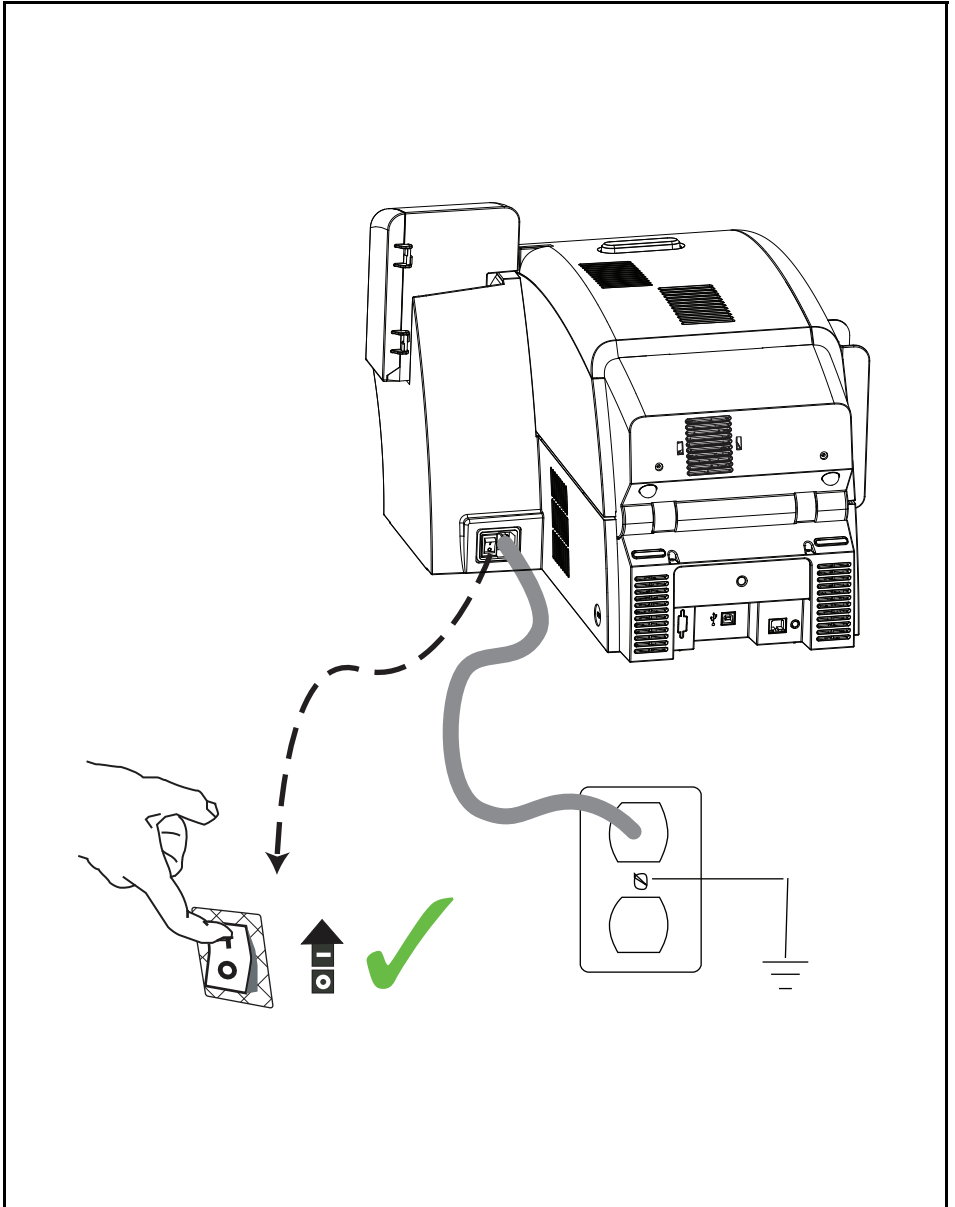
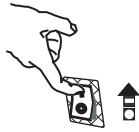

18

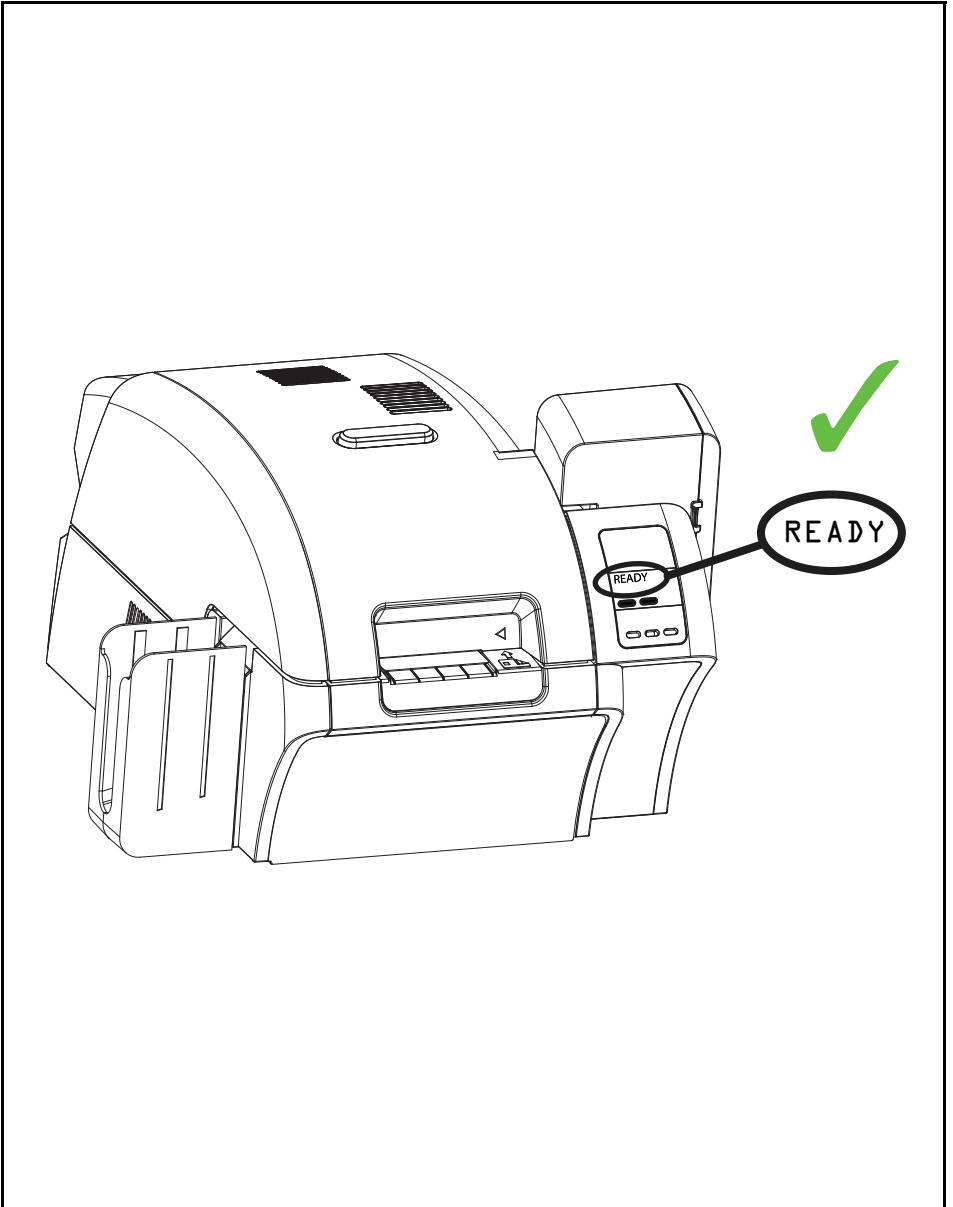

North America and Latin America:

Zebra Technologies
Card Printer Solutions
1001 Flynn Road
Camarillo, CA 93012-8706 USA
Phone: 800-511-9909 (when calling within the U.S.)
Phone: +1 805 577-7002, option 1 (when calling from Latin America)
e-mail: techsupport@zebra.com



Europe, Middle East, and Africa:

Zebra Technologies
Card Printer Solutions, Europe, Middle East, Africa
Dukes Meadow
Millboard Road, Bourne End
Buckinghamshire SL8 5XF, England
Phone: + 44 (0) 1628 556 000 (from outside U.K.)
Phone: 1628 556 000 (from inside U.K.)
FAX: + 44 (0) 1628 556 001
e-mail: tseurope@zebra.com



Asia Pacific:

Zebra Technologies Asia Pacific, LLC
120 Robinson Road
#06-01 Parakou Building
Singapore 068913
Phone: + 65 6885 0772
e-mail: tsasiapacific@zebra.com

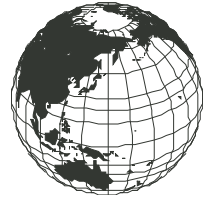

Website

www.zebracard.com



**Printed on
chlorine-free
recycled paper.**



**Card
Printer
Solutions**



P1004624- 002

Free Manuals Download Website

<http://myh66.com>

<http://usermanuals.us>

<http://www.somanuals.com>

<http://www.4manuals.cc>

<http://www.manual-lib.com>

<http://www.404manual.com>

<http://www.luxmanual.com>

<http://aubethermostatmanual.com>

Golf course search by state

<http://golfingnear.com>

Email search by domain

<http://emailbydomain.com>

Auto manuals search

<http://auto.somanuals.com>

TV manuals search

<http://tv.somanuals.com>