

Installation and Operating Guide

Model Numbers | P42W34, P42W34H | PLASMA TV



Warning



CAUTION
RISK OF ELECTRIC SHOCK
DO NOT OPEN



WARNING:

TO REDUCE THE RISK OF ELECTRIC SHOCK DO NOT REMOVE COVER (OR BACK). NO USER SERVICEABLE PARTS INSIDE. REFER TO QUALIFIED SERVICE PERSONNEL.



The lightning flash with arrowhead symbol, within an equilateral triangle, is intended to alert the user to the presence of uninsulated "dangerous voltage" within the product's enclosure that may be of sufficient magnitude to constitute a risk of electric shock to persons.



The exclamation point within an equilateral triangle is intended to alert the user to the presence of important operating and maintenance (servicing) instructions in the literature accompanying the appliance.

WARNING:

TO PREVENT FIRE OR SHOCK HAZARDS, DO NOT EXPOSE THIS PRODUCT TO RAIN OR MOISTURE.

NOTE TO CABLE/TV INSTALLER:

This reminder is provided to call the CATV system installer's attention to Article 820-40 of the National Electric Code (U.S.A.). The code provides guidelines for proper grounding and, in particular, specifies that the cable ground shall be connected to the grounding system of the building, as close to the point of the cable entry as practical.

REGULATORY INFORMATION

This equipment has been tested and found to comply with the limits for a Class B digital device, pursuant to Part 15 of the FCC Rules. These limits are designed to provide reasonable protection against harmful interference in a residential installation. This equipment generates, uses and can radiate radio frequency energy and, if not installed and used in accordance with the instructions, may cause harmful interference to radio communications. However, there is no guarantee that interference will not occur in a particular installation. If this equipment does cause harmful interference to radio or television reception, which can be determined by turning the equipment off and on, the user is encouraged to try to correct the interference by one or more of the following measures:

- Reorient or relocate the receiving antenna.
- Increase the separation between the equipment and receiver.
- Connect the equipment into an outlet on a circuit different from that to which the receiver is connected.
- Consult the dealer or an experienced radio/TV technician for help.

Any changes or modifications not expressly approved by the party responsible for compliance could void the user's authority to operate the equipment.

CAUTION:

Do not attempt to modify this product in any way without written authorization from Zenith Electronics Corporation. Unauthorized modification could void the user's authority to operate this product.

COMPLIANCE:

The responsible party for this product's compliance is:
Zenith Electronics Corporation
2000 Millbrook Drive
Lincolnshire, IL 60069, USA
Phone: 1-847-941-8000

Safety Instructions

Important safeguards for you and your new product

Your product has been manufactured and tested with your safety in mind. However, improper use can result in potential electrical shock or fire hazards. To avoid defeating the safeguards that have been built into your new product, please read and observe the following safety points when installing and using your new product, and save them for future reference.

Observing the simple precautions discussed in this booklet can help you get many years of enjoyment and safe operation that are built into your new product.

This product complies with all applicable U.S. Federal safety requirements, and those of the Canadian Standards Association.

1. Read Instructions

All the safety and operating instructions should be read before the product is operated.

2. Follow Instructions

All operating and use instructions should be followed.

3. Retain Instructions

The safety and operating instructions should be retained for future reference.

4. Heed Warnings

All warnings on the product and in the operating instructions should be adhered to.

5. Cleaning

Unplug this product from the wall outlet before cleaning. Do not use liquid cleaners or aerosol cleaners. Use a damp cloth for cleaning.

6. Water and Moisture

Do not use this product near water, for example, near a bath tub, wash bowl, kitchen sink, or laundry tub, in a wet basement, or near a swimming pool.

7. Accessories, Carts, and Stands

Do not place this product on a slippery or tilted surface, or on an unstable cart, stand, tripod, bracket, or table. The product may slide or fall, causing serious injury to a child or adult, and serious damage to the product. Use only with a cart, stand, tripod, bracket, or table recommended by the manufacturer, or sold with the product. Any mounting of the product should follow the manufacturer's instructions, and should use a mounting accessory recommended by the manufacturer.

8. Transporting Product

A product and cart combination should be moved with care. Quick stops, excessive force, and uneven surfaces may cause the product and cart combination to overturn.

9. Attachments

Do not use attachments not recommended by the product manufacturer as they may cause hazards.

10. Ventilation

Slots and openings in the cabinet are provided for ventilation and to ensure reliable operation of the product and to protect it from overheating, and these openings must not be blocked or covered. The openings should never be blocked by placing the product on a bed, sofa, rug, or other similar surface. This product should not be placed in a built-in installation such as a bookcase or rack unless proper ventilation is provided or the manufacturer's instructions have been adhered to.

11. Power Sources

This product should be operated only from the type of power source indicated on the marking label. If you are not sure of the type of power supply to your home, consult your product dealer or local power company. For products intended to operate from battery power, or other sources, refer to the operating instructions.

12. Power-Cord Polarization

This product is equipped with a three-wire grounding type plug, a plug having a third (grounding) pin. This plug will only fit into the grounding-type power outlet. This is a safety feature. If you are unable to insert the plug into the outlet, contact your electrician to replace your obsolete outlet. Do not defeat the safety purpose of the grounding-type plug.

13. Power-Cord Protection

Power-supply cords should be routed so that they are not likely to be walked on or pinched by items placed upon or against them, paying particular attention to cords at plugs, convenience receptacles, and the point where they exit from the product.



PORTABLE CART WARNING

(Continued on next page)

Safety Instructions continued

14. Outdoor Antenna Grounding

If an outside antenna or cable system is connected to the product, be sure the antenna or cable system is grounded so as to provide some protection against voltage surges and built-up static charges. Article 810 of the National Electrical Code (U.S.A.), ANSI/ NFPA 70 provides information with regard to proper grounding of the mast and supporting structure, grounding of the lead-in wire to an antenna discharge unit, size of grounding conductors, location of antenna-discharge unit, connection to grounding electrodes, and requirements for the grounding electrode.

Example of Grounding According to National Electrical Code Instructions

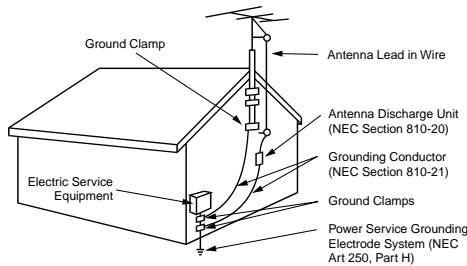

NEC - National Electrical Code

15. Lightning

For added protection for this product (receiver) during a lightning storm, or when it is left unattended and unused for long periods of time, unplug it from the wall outlet and disconnect the antenna or cable system. This will prevent damage to the product due to lightning and power-line surges.

16. Power Lines

An outside antenna system should not be located in the vicinity of overhead power lines or other electric light or power circuits, or where it can fall into such power lines or circuits. When installing an outside antenna system, extreme care should be taken to keep from touching such power lines or circuits as contact with them might be fatal.

17. Overloading

Do not overload wall outlets and extension cords as this can result in a risk of fire or electric shock.

18. Object and Liquid Entry

Never push objects of any kind into this product through openings as they may touch dangerous voltage points or short-out parts that could result in a fire or electric shock. Never spill liquid of any kind on the product.

19. Servicing

Do not attempt to service this product yourself as opening or removing covers may expose you to dangerous voltage or other hazards. Refer all servicing to qualified service personnel.

20. Damage Requiring Service

Unplug this product from the wall outlet and refer servicing to qualified service personnel under the following conditions:

- a. If the power-supply cord or plug is damaged.
- b. If liquid has been spilled, or objects have fallen into the product.
- c. If the product has been exposed to rain or water.
- d. If the product does not operate normally by following the operating instructions. Adjust only those controls that are covered by the operating instructions as an improper adjustment of other controls may result in damage and will often require extensive work by a qualified technician to restore the product to its normal operation.
- e. If the product has been dropped or the cabinet has been damaged.
- f. If the product exhibits a distinct change in performance.

21. Replacement Parts

When replacement parts are required, be sure the service technician has used replacement parts specified by the manufacturer or have the same characteristics as the original part. Unauthorized substitutions may result in fire, electric shock, or other hazards.

22. Safety Check

Upon completion of any service or repairs to this product, ask the service technician to perform safety checks to determine that the product is in proper operating condition.

23. Wall or Ceiling Mounting

The product should be mounted to a wall or ceiling only as recommended by the manufacturer. The product may slide or fall, causing serious injury to a child or adult, and serious damage to the product.

24. Heat

The product should be situated away from heat sources such as radiators, heat registers, stoves, or other products (including amplifiers) that produce heat.

Contents

Warnings2	Special Menu Options	
Safety Instructions3~4	Key Lock23
Introduction		ISM Method23
Controls7	Low power23
Connection Options8	Caption/Text25
Remote Control Key Functions9	Captions25
Installation		Screen Menu Options	
External Equipment Connections12~16	Auto Adjustment26
Antenna Connection12	Setting Picture Format26
VCR Setup13	Picture Size Zoom26
Cable TV Setup13	Adjusting Horizontal/Vertical Position27
External A/V Source Setup14	Manual Configure27
DVD Setup14	Screen Adjustments27
DTV Setup14	Initializing27
Monitor Out Setup15	Luminance Noise Reduction28
PC Setup15~16	Selecting Wide VGA mode28
		Split Zoom28
Operation		PIP (Picture-in-Picture) Feature	
Turning on the TV17	Watching PIP29
Menu Language Selection17	Swapping PIP29
Channel Menu Options		Moving PIP29
Memorizing the Channels with Auto program ..	.18	TV Program selection for PIP29
Memorizing the Channels with Manual Program ..	.18	Selecting an Input Signal Source for PIP29
Fine Tuning Adjustment18	PIP Aspect Ratio29
Favorite Channel Memory18	Double Window Setup Options	
Picture Menu Options		Watching the Double Window30
APC (Auto Picture Control)19	Sub Picture Size Adjustment30
Manual Picture Control19	Swapping the Double Window30
Auto Color Temperature Control19	Selecting a Source for the Double Window30
Manual Color Temperature Control19	Lock Menu Options	
Sound Menu Options		Lock Setup31~32
DASP (Digital Auto Sound Processing)20	External Control Device Setup33~38
AVL (Auto Volume Leveler)20	IR Code (NEC format)39~40
Manual Sound Control20	Troubleshooting Checklist41~42
Stereo/SAP Broadcasts Setup20	Maintenance43
Time Menu Options		Specifications44
Auto Clock Setup21		
Manual Clock Setup21		
On/Off Timer Setup21		
Auto Off22		
Sleep Timer22		

Setup and Operation Checklist

Setup and Operation Checklist

(See pages 12~15 for available connection and operational setup options.)

1. Unpack the TV and all accessories.
2. Connect all external video and audio equipment.
see pages 13 ~ 15.
3. Install batteries in remote control.
See page 9.
4. Turn the TV on.
See page 17.
5. Turn video source equipment on.
6. Select viewing source for the TV.
See page 9.
7. Fine-tune source image and sound to personal preference
or as required by source.
See pages 19 ~ 20.
8. Additional features Setup
See Contents above.

After reading this manual, keep it handy for future reference.

Introduction

What is a Plasma Display Panel (PDP)?

If voltage is applied to gas within glass panels, ultraviolet rays are produced and fused with a fluorescent substance. At that instant, light is emitted. A Plasma Display is a next generation flat Display using this phenomenon.

160° - Wide angle range of vision

Your flat panel plasma screen offers an exceptionally broad viewing angle -- over 160 degrees. This means that the display is clear and visible to viewers anywhere in the room.

Wide Screen

The screen of the Plasma Display is 42" so wide that your viewing experience is as if you are in a theater.

Multimedia

Connect your plasma display to a PC and you can use it for conferencing, games, and internet browsing. The Picture-in-Picture feature allows you to view your PC and video images simultaneously.

Versatile

The light weight and thin size makes it easy to install your plasma display in a variety of locations where conventional TVs will not fit.

The PDP Manufacturing Process: Why minute colored dots may be present on the PDP screen

The PDP (Plasma Display Panel) which is the display device of this product is composed of 0.9 to 2.2 million cells. A few cell defects will normally occur in the PDP manufacturing process. Several minute colored dots visible on the screen should be acceptable. This also occurs in other PDP manufacturers' products and the tiny dots appearing does not mean that this PDP is defective. Thus a few cell defects are not sufficient cause for the PDP to be exchanged or returned. Our production technology is designed to minimize cell defects during the manufacture and operation of this product.

WARNING

TO REDUCE THE RISK OF FIRE AND ELECTRIC SHOCK, DO NOT EXPOSE THIS PRODUCT TO RAIN OR MOISTURE.

Controls

Front Panel Controls

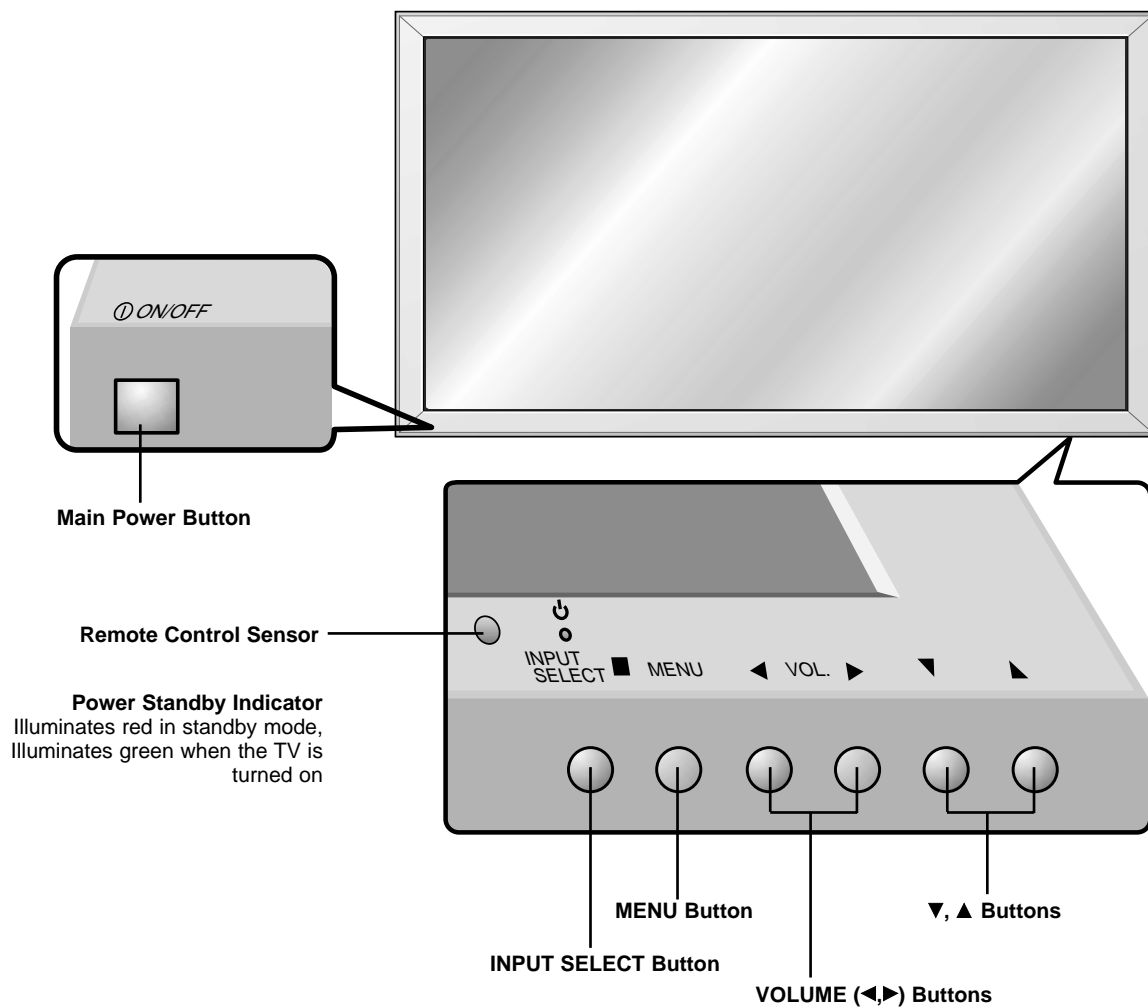

Connection Options

Back Connection Panel

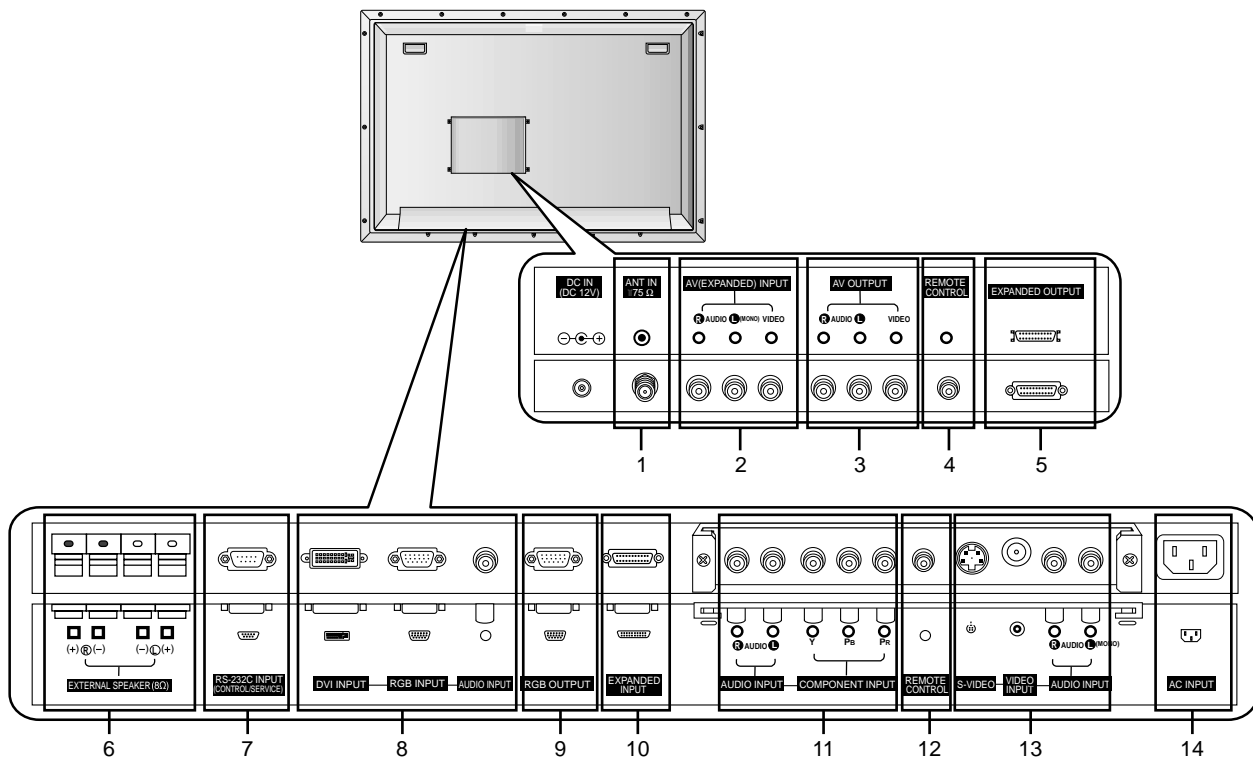

1. ANTENNA INPUT PORT

Connection for an over-the-air or terrestrial antenna, your cable TV wire, or cable box.

2. AV (EXPANDED) INPUT

Connection for audio/video out from external equipment.

3. AV OUTPUT

Connection for a second TV or monitor.

4. REMOTE CONTROL

Connect your wired remote control to the remote control port on the TV.

5. EXPANDED OUTPUT

Connect the TV to the TV with the tuner box cable.

6. EXTERNAL SPEAKER (8 ohm output)

Connect to optional external speaker(s).

* For further information, refer to 'Speaker & Speaker Stand' manual.

7. RS-232C INPUT (CONTROL/SERVICE) PORT

Connect to the RS-232C port on a PC.

8. DVI (Digital Visual Interface) INPUT/ RGB INPUT/AUDIO INPUT JACKS

Connect the TV output connector from a PC to the appropriate input port.

9. RGB OUTPUT PORT

You can watch the RGB signal on another monitor, connect RGB OUTPUT to another monitor's PC input port.

10. EXPANDED INPUT

Connect the plasma display to the Tuner with the tuner box cable supplied.

11. COMPONENT INPUT/AUDIO INPUT JACKS

Connect a component video device to these jacks.

12. REMOTE CONTROL

Connect your wired remote control to the remote control port on the TV.

13. S-VIDEO INPUTS

Connect S-Video out from an S-VIDEO VCR to the S-VIDEO input.

AUDIO/VIDEO INPUT JACKS

Connect audio/video out from external equipment to these jacks.

14. POWER CORD SOCKET

This TV operates on an AC power. The voltage is indicated on the Specifications page. Never attempt to operate the TV on DC power.

Remote Control Key Functions

- When using the remote control, aim it at the remote control sensor on the TV.
- Under certain conditions such as if the remote IR signal is interrupted, the remote control may not function. Press the key again as necessary.

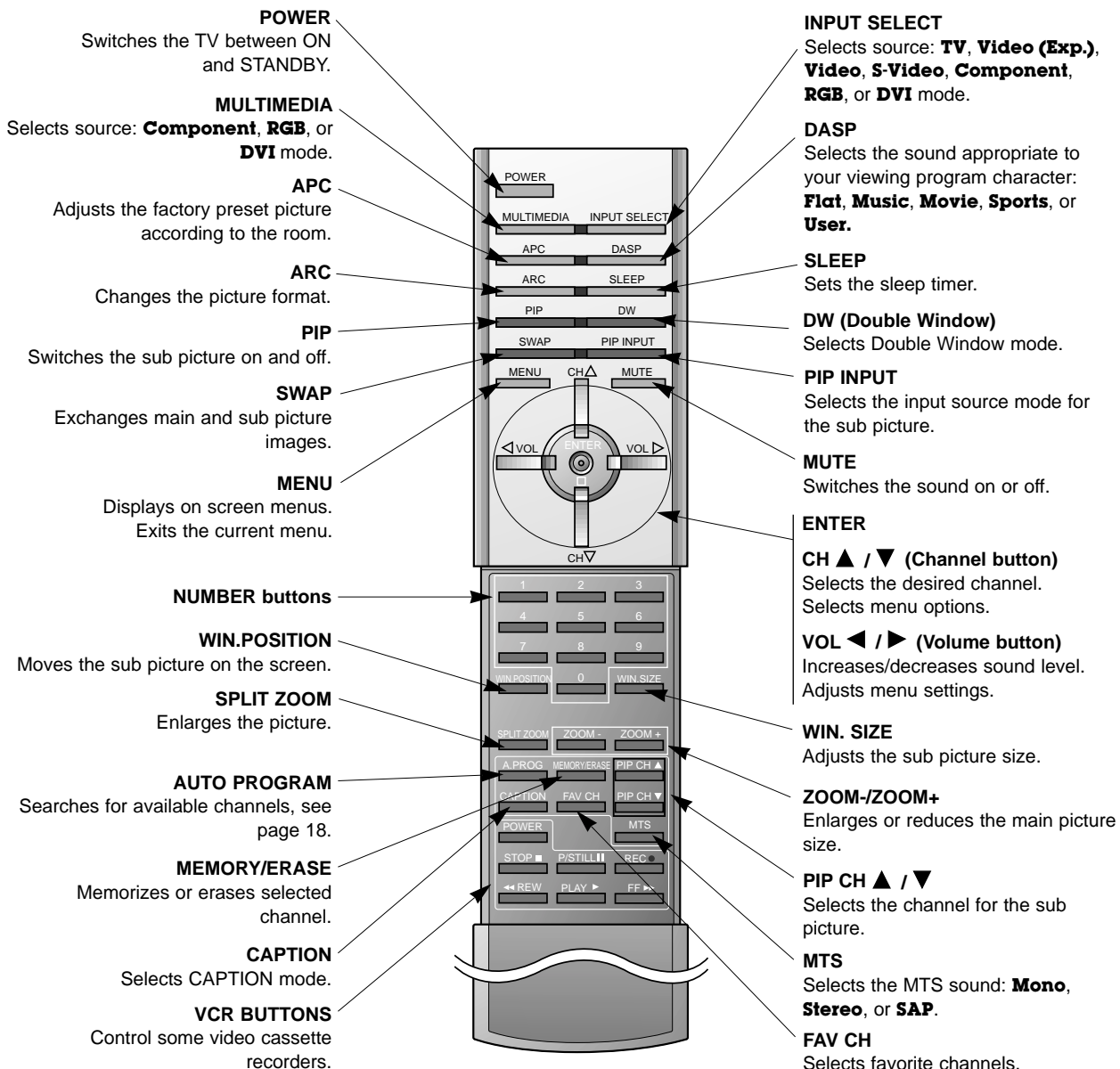

Installing Batteries

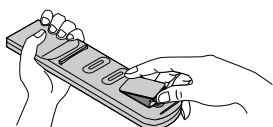

- Open the battery compartment cover on the back side and insert the batteries with correct polarity.
- Install two 1.5V batteries of AAA type. Don't mix used batteries with new batteries.

Installation

Ensure that the following accessories are included with your TV. If an accessory is missing, please contact the dealer where you purchased the product.

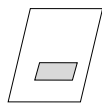

Owner's Manual

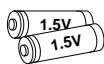

Batteries



BNC-RCA Adapter



Remote Control

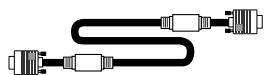

D-sub 15 pin Cable



Power Cord



DVI-D Cable



Tuner Box Cable

Installation Instructions

GROUNDING

Ensure that you connect the grounding / earth wire to prevent possible electric shock. If grounding methods are not possible, have a qualified electrician install a separate circuit breaker. Do not try to ground the unit by connecting it to telephone wires, lightening rods, or gas pipes.

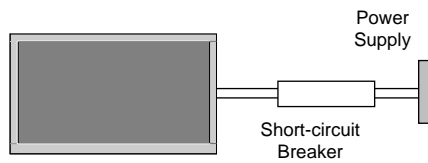

- The TV can be installed in various ways such as on a wall, or on a desktop etc.
- The TV is designed to be mounted horizontally. The speakers shown are optional.

Wall Mount Installation



For proper ventilation, allow a clearance of 4" on each side and 2" from the wall. Detailed installation instructions are included in the optional Wall Mounting Bracket Installation and Setup Guide, see your dealer.

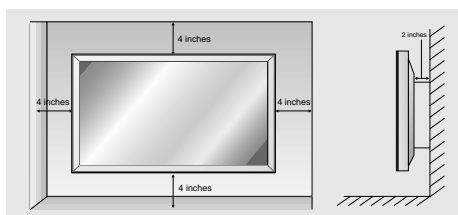

Desktop Pedestal Installation

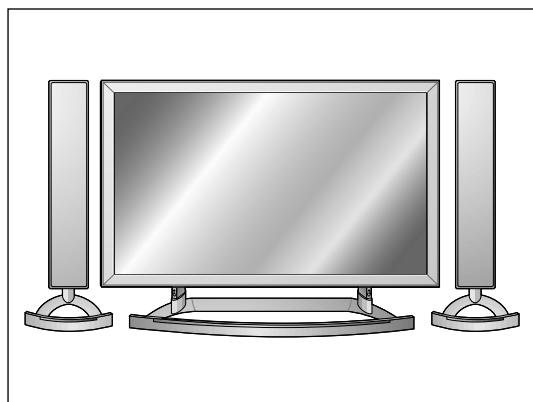

For proper ventilation, allow a clearance of 4" on each side and the top, 2.36" on the bottom, and 2" from the wall. Detailed installation instructions are included in the optional Desktop Stand Installation and Setup Guide, see your dealer.

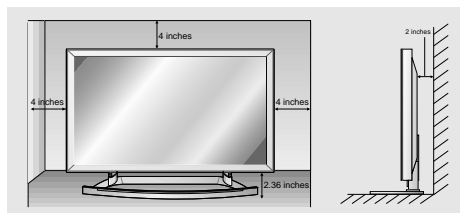

External Equipment Connections

Antenna Connection

- Antenna or Cable Service without a Cable Box Connections
- For optimum picture quality, adjust antenna direction if needed.

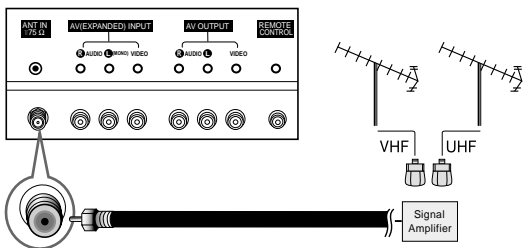
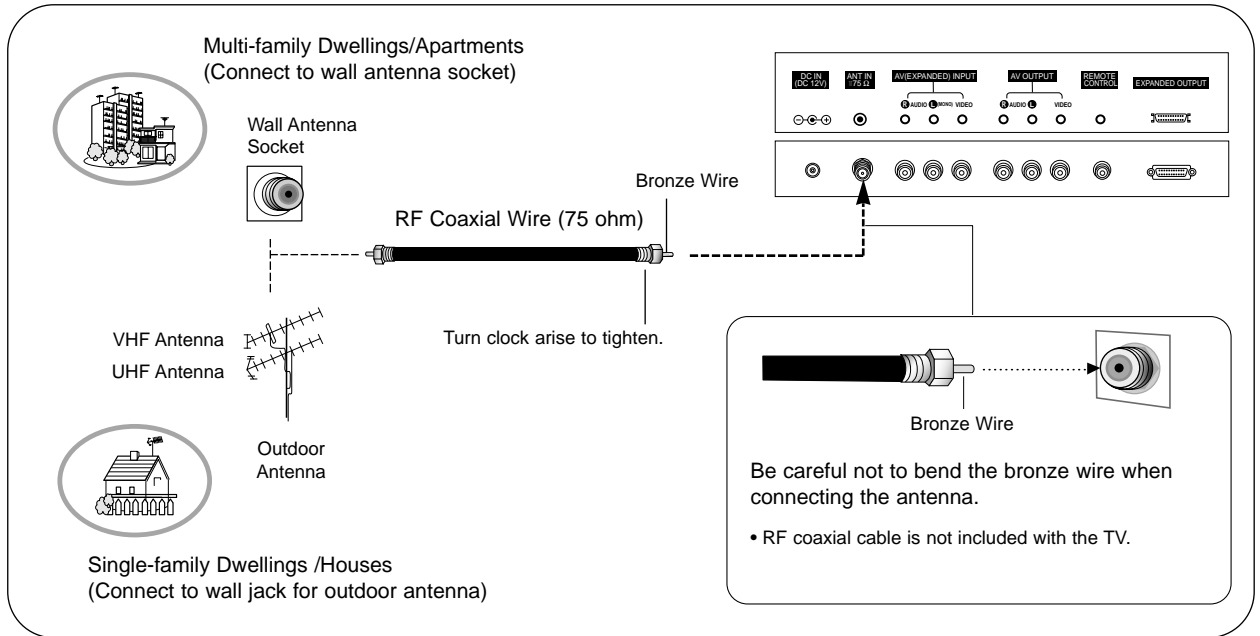

- In a poor signal area, purchase and install a signal amplifier for better picture quality.
- If the antenna needs to be split for two TV, include a "2-Way Signal Splitter" in the connections.
- If the antenna is not installed properly, contact your dealer for assistance.

NOTE: Not all cables shown are included with the TV.

VCR Setup

- To avoid picture noise (interference), leave an adequate distance between the VCR and TV.
- Use the ISM Method feature to avoid having a fixed image remain on the screen for a long period of time. Typically a frozen still picture from a VCR. If the 4:3 picture format is used; the fixed image may remain visible on the screen.

Connection 1

Set VCR switch to 3 or 4 and then tune TV to the same channel number.

Connection 2

1. Connect the audio and video cables from the VCR's output jacks to the TV input jacks, as shown in the figure.
When connecting the TV to VCR, match the jack colors (Video = yellow, Audio Left = white, and Audio Right = red).
2. Insert a video tape into the VCR and press PLAY on the VCR. (Refer to the VCR owner's manual.)
3. Use the **INPUT SELECT** button on the remote control to select **Video (Exp.)**.

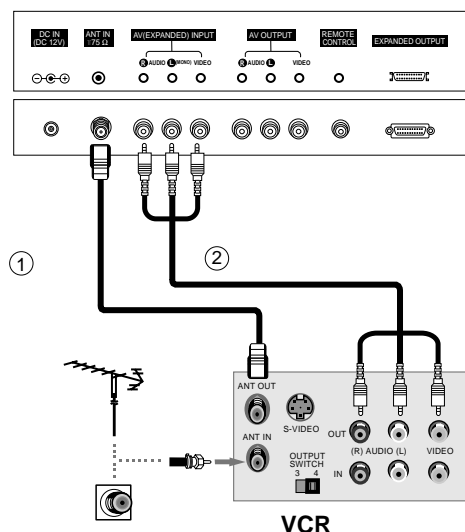

Cable TV Setup

- After subscribing to a cable TV service from a local provider and installing a converter, you can watch cable TV programming.
- For further information regarding cable TV service, contact your local cable TV service provider(s).

Connection 1

1. Select 3 or 4 with channel switch on cable box.
2. Tune the TV channel to the same selected output channel of cable box.
3. Select channels at the cable box or with the cable box remote control.

Connection 2

1. Connect the audio and video cables from the cable box's output jacks to the TV input jacks, as shown in the figure.
When connecting the TV to cable box, match the jack colors (Video = yellow, Audio Left = white, and Audio Right = red).
2. Use the **INPUT SELECT** button on the remote control to select **Video (Exp.)**.
3. Select channels with the cable box remote control.

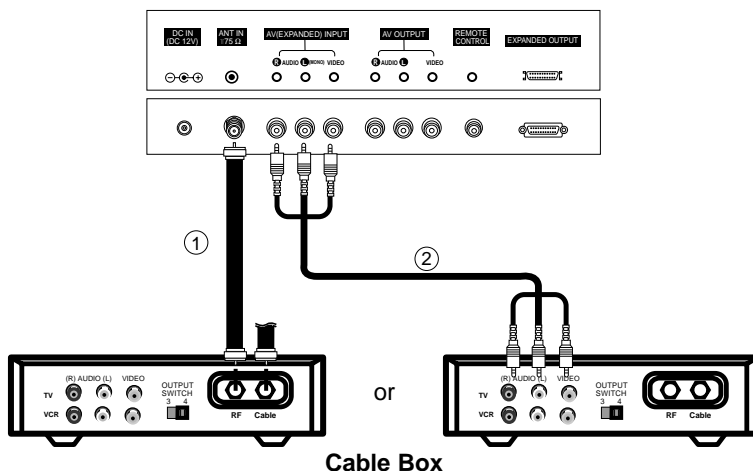

External A/V Source Setup

How to connect

Connect the audio and video cables from the external equipment's output jacks to the TV input jacks, as shown in the figure.

When connecting the TV to external equipment, match the jack colors (Video = yellow, Audio Left = white, and Audio Right = red).

How to use

1. Use the **INPUT SELECT** button on the remote control to select **Video (Exp.)**.
2. Operate the corresponding external equipment. Refer to external equipment operating guide.

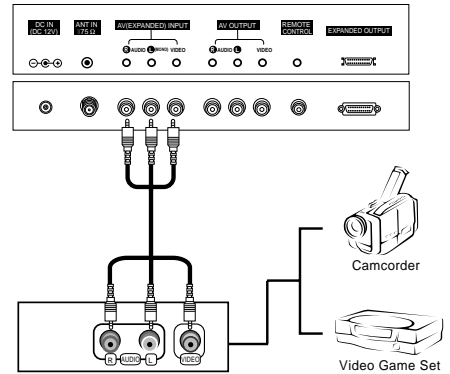

DVD Setup

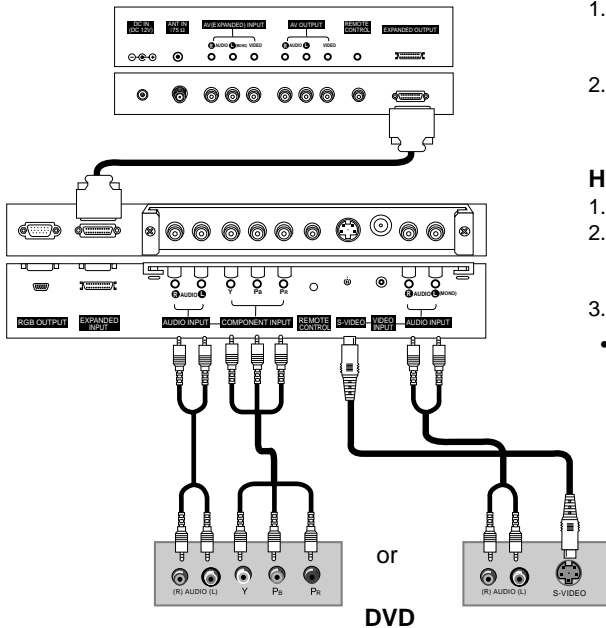

How to connect

1. Connect the DVD video outputs to the **COMPONENT INPUT** jacks (Y, Pb, Pr) and connect the DVD audio outputs to the **AUDIO INPUT** jacks.
2. If your DVD only has an S-Video output jack, connect this to the **S-VIDEO** input on the TV and connect the DVD audio outputs to the **AUDIO INPUT** jacks.

How to use

1. Turn on the DVD player, insert a DVD.
2. Use the **INPUT SELECT** button on the remote control to select **Component**. (If connected to S-VIDEO, select the **S-Video** external input source.)
3. Refer to the DVD player's manual for operating instructions.

• Component Input ports

To get better picture quality, connect a DVD player to the component input ports as shown below.

The TV Component Ports	Y	Pb	Pr
DVD Player Video Output Ports	Y	Pb	Pr
	Y	B-Y	R-Y
	Y	Cb	Cr
	Y	PB	PR

DTV Setup

- To watch digitally broadcast programs, purchase and connect a digital set-top box.
- This TV supports HDCP (High-bandwidth Digital Contents Protection) protocol for DTV (480p, 720p, 1080i) modes.

How to connect

1. Use the TV's **COMPONENT** (Y, Pb, Pr) **INPUT**, **RGB**, or **DVI** jack for video connections, depending on your set-top box connector. Then, make the corresponding audio connections.

How to use

1. Turn on the digital set-top box. (Refer to the owner's manual for the digital set-top box.)
2. Use **INPUT SELECT** on the remote control to select **Component**, **RGB** or **DVI**.

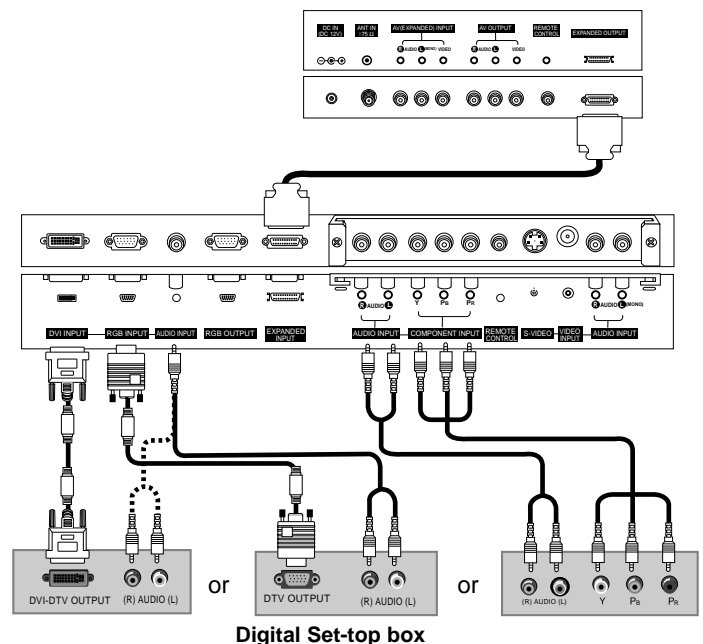

Monitor Out Setup

The TV has a special signal output capability which allows you to hook up a second TV or monitor.

Connect the second TV or monitor to the TV's AV OUTPUT. See the Operating Manual of the second TV or monitor for further details regarding that device's input settings.

NOTE: • Component, RGB-PC/DTV 480p/720p/1080i input sources cannot be used for Monitor out.

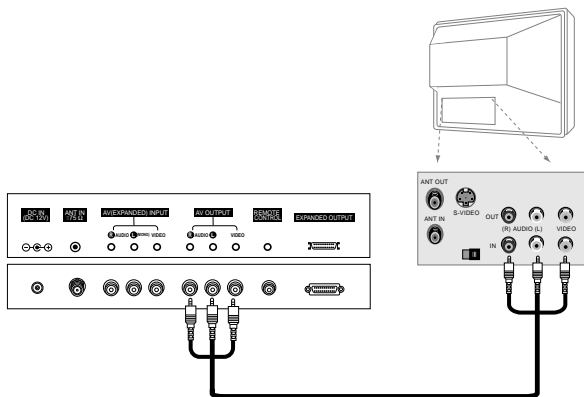

PC Setup

- This TV provides Plug and Play capability, meaning that the PC adjusts automatically to its settings. The TV sends configuration information (EDID) to the PC using the Video Electronics Standard Association (VESA) Display Data Channel (DDC) protocol.

How to connect

1. To get the best picture quality, adjust the PC graphics card to a 640x480, 60Hz.
2. Use the TV's RGB INPUT or DVI (Digital Visual Interface) INPUT port for video connections, depending on your PC connector. If the graphic card on the PC does not output analog and digital RGB simultaneously, connect only one of both RGB INPUT or DVI INPUT to display the PC on the TV. If the graphic card on the PC does output analog and digital RGB simultaneously, set the TV to either RGB or DVI; (the other mode is set to Plug and Play automatically by the TV.)
3. Then, make the corresponding audio connections. If using a sound card, adjust the PC sound as required.

How to use

1. Turn on the PC and the TV.
2. Turn on the display by pressing the POWER button on the TV's remote control.
3. Use the **INPUT SELECT** button on the remote control to select **RGB** or **DVI**.
4. Check the image on your TV. There may be noise associated with the resolution, vertical pattern, contrast or brightness in PC mode. If noise is present, change the PC mode to another resolution, change the refresh rate to another rate or adjust the brightness and contrast on the menu until the picture is clear. If the refresh rate of the PC graphic card can not be changed, change the PC graphic card or consult the manufacturer of the PC graphic card.

- NOTES:**
- Depending on the graphics card, DOS mode may not work if you use a DVI-I cable.
 - Avoid keeping a fixed image on the TV's screen for a long period of time. The fixed image may become permanently imprinted on the screen. Use the Orbiter screen saver when possible.
 - The synchronization input form for Horizontal and Vertical frequencies is separate.

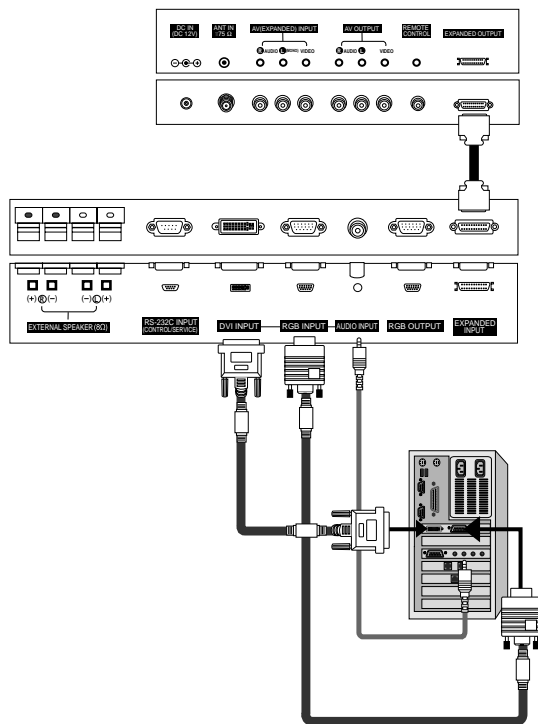

Monitor Display Specifications (RGB-PC /DVI-PC Mode)

Resolution	Horizontal Frequency(KHz)	Vertical Frequency(Hz)	Resolution	Horizontal Frequency(KHz)	Vertical Frequency(Hz)
640x350	31.468	70.09	800x600	35.156	56.25
	37.861	85.08		37.879	60.31
720x400	31.469	70.08		48.077	72.18
	37.927	85.03		46.875	75.00
640x480	31.469	59.94		53.674	85.06
	35.000	66.66		832x624	49.725
	37.861	72.80	1024x768	48.363	60.00
	37.500	75.00		56.476	70.06
	43.269	85.00		60.023	75.02
848x480	31.500	60.00	1152x864	54.348	60.05
	35.00	70.00		63.995	70.01
	37.500	75.00		67.500	75.00
852x480	31.500	60.00	1152x870	68.681	75.06
	35.000	70.00	1280x960	60.000	60.00
	37.500	75.00	1280x1024	63.981	60.02

Operation

Turning on the TV

Turning on the TV just after installation

1. Connect power cord correctly.
2. Press the **ON/OFF** button on the TV. At this moment, the TV is switched to standby mode. Press the **INPUT SELECT**, **▲ / ▼** button on the TV or press the **POWER**, **INPUT SELECT**, **MULTIMEDIA**, **CH (▲ / ▼)**, **FAV CH**, **Number** button on the remote control to switch the TV on.

Turning on the TV (power cord is still connected)

1. If the TV was turned off with the **ON/OFF** button on the TV
 - Press the **ON/OFF** button on the TV to turn the TV on.
 2. If the TV was turned off with the remote control and the **ON/OFF** button on the TV
 - Press the **ON/OFF** button on the TV and then press the **INPUT SELECT** button on the TV. Or, on the remote control, press either **POWER**, **INPUT SELECT**, **MULTIMEDIA**, **CH (▲ / ▼)**, **FAV CH**, **Number** to turn the TV on.
- **CAUTION**
If you connect or disconnect the Tuner Box cable to the TV, the TV is switched to standby mode.

Menu Language Selection

- The menus can be shown on the screen in the selected language. First select your language.

1. Press the **MENU** button and then use **▲ / ▼** button to select the **SPECIAL** menu.
2. Press the **▶** button and then use **▲ / ▼** button to select **Language**.
3. Press the **▶** button and then use **▲ / ▼** button to select your desired language.
From this point on, the on-screen menus will be shown in the language of your choice.
4. Press the **MENU** button to save.



Channel Menu Options

Auto Programming is used to memorize all the active channels in your area before you can use the TV.

There are two ways of storing channels in the Tuner's memory. You can use either.

One is called AUTO PROGRAM and the other is called MANUAL PROGRAM.

In AUTO PROGRAM mode, the TV will memorize the channels in ascending numerical order. If there are additional channels you want to add or delete, you can manually add or delete those channels with Manual Program.

Memorizing the Channels with Auto Program

- Redo Auto Program if the TV is ever moved to another location.
- Auto Program will only operate with the ANT. connected.
- If channels numbers for broadcast over-the air TV and cable TV are duplicated where different channels have the same number, press the same number buttons again to toggle between:



: (For example, press 17 to go to the channel, press 17 again to go to the duplicated channel.)

1. Press the **A.PROG** button and then press the ► button. AUTO PROGRAM starts the channel search.

If you want to stop auto programming, press the **ENTER** button. Only the channels searched up to that time are memorized.

- You can also select the **Auto program** option and do a channel search in the **CHANNEL** menu.



Memorizing the Channels with Manual Program

- You can memorize or erase channels manually.

1. Use the ▲ / ▼ or NUMBER buttons to select the channel number you want to memorize or erase.
2. Press the **MEMORY/ERASE** button.
3. Use the **MEMORY/ERASE** button to select **Memory** or **Erase**.
4. Press the **ENTER** button.

- You can also do **Manual program** with the **CHANNEL** menu.

Fine Tuning Adjustment

- This function adjusts the pictures stability and condition when it is poor.

1. Press the **MENU** button and then use ▲ / ▼ button to select the **CHANNEL** menu.
2. Press the ► button and then use ▲ / ▼ button to select **Manual program**.
3. Press the ► button and then use ◀ / ▶ button to select **Fine**.
4. Use the ▲ / ▼ button to adjust the picture to your preference.
5. Press the **ENTER** button to save.



Favorite Channel Memory

- Favorite channel memory is a convenient feature that lets you quickly scan up to 5 channels of your choice without having to wait for the TV to scan through all the in-between channels.

1. Press the **MENU** button and then use ▲ / ▼ button to select the **CHANNEL** menu.
2. Press the ► button and then use ▲ / ▼ button to select **Favorite ch..**
3. Press the ► button and then use ▲ / ▼ button to select the first favorite channel position.
4. Use the ◀ / ▶ button to set the desired channel number for first favorite channel.
5. Repeat steps 3 to 4 to memorize other favorite channels.
6. Press the **ENTER** button to save.

- To tune to a favorite channel, press the **FAV CH** (Favorite channel) button repeatedly. The five favorite channels appear on the screen in numerical order.

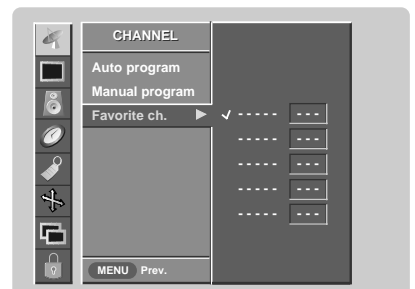

Picture Menu Options

- Picture menu adjustment are unique to each input source. Readjust Picture menu settings for each following input source as preferred.
 - RGB (PC) / DVI (PC),
 - RGB (DTV) / DVI (DTV) / Component (480p, 720p, 1080i)
 - Video / S-Video / Component (480i)

APC (Auto Picture Control)

- APC adjusts the TV for the best picture appearance.
- When adjusting picture options (contrast, brightness, color, sharpness and tint) manually, APC automatically changes to **User**.

1. Press the **APC** button repeatedly to select the picture appearance setup option as shown below.

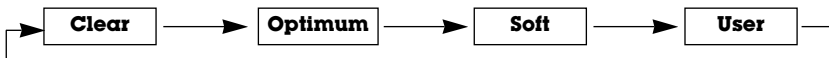

- You can also adjust **APC** in the **PICTURE** menu.
- **Clear**, **Optimum**, and **Soft** settings are preset for optimum picture quality at the factory and cannot be changed.

Manual Picture Control (**User** option)

- You can adjust picture contrast, brightness, color, sharpness and tint to the levels you prefer.

1. Press the **MENU** button and then use **▲ / ▼** button to select the **PICTURE** menu.
2. Press the **▶** button and then use **▲ / ▼** button to select the desired picture option (**Contrast**, **Brightness**, **Color**, **Sharpness**, **Tint**).
3. Press the **▶** button and then use **◀ / ▶** button to make appropriate adjustments.
4. Press the **ENTER** button to save.

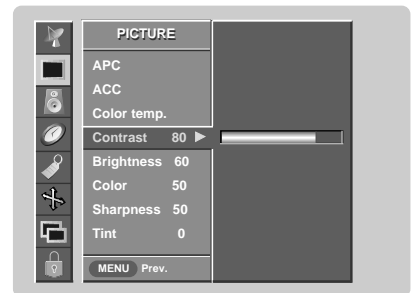

Auto Color Temperature Control

- To initialize values (reset to default settings), select the **Normal** option.
- When adjusting color temperature options (red, green, or blue) manually, ACC automatically changes to **User**.

1. Press the **MENU** button and then use **▲ / ▼** button to select the **PICTURE** menu.
2. Press the **▶** button and then use **▲ / ▼** button to select **ACC**.
3. Press the **▶** button and then use **▲ / ▼** button to select either **Normal** (Default), **Cool** (Preset), **Warm** (Preset) or **User** (Manual Adjustment).
4. Press the **ENTER** button to save.

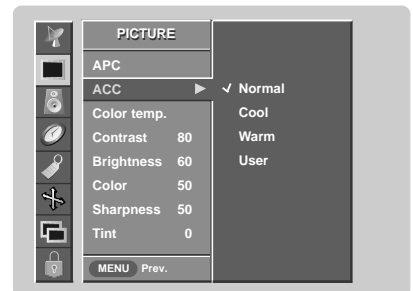

Manual Color Temperature Control (**User** option)

- You can adjust red, green, and blue to any color temperature you prefer.

1. Press the **MENU** button and then use **▲ / ▼** button to select the **PICTURE** menu.
2. Press the **▶** button and then use **▲ / ▼** button to select **Color temp.**
3. Press the **▶** button and then use **▲ / ▼** button to select **Red**, **Green** or **Blue**.
 - The adjustment range for **Red**, **Green**, and **Blue** is -20 ~ +20.
4. Use the **◀ / ▶** button to make appropriate adjustments.
5. Press the **ENTER** button to save.

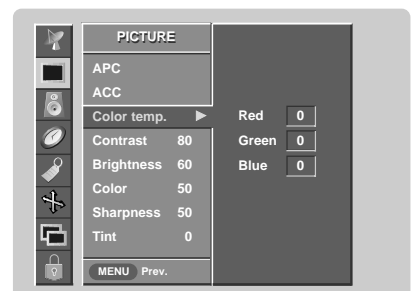

Sound Menu Options

DASP (Digital Auto Sound Processing)

- DASP lets you enjoy the best sound without any special adjustment because the TV has the appropriate sound option based on the program content.
- When adjusting sound options (treble, bass, and balance) manually, DASP automatically changes to **User**.

1. Press the **DASP** button repeatedly to select the appropriate sound setup as shown below.



- You can also adjust **DASP** in the **SOUND** menu.
- **Flat, Music, Movie** and **Sports** are preset for good sound quality at the factory and cannot be changed.

AVL (Auto Volume Leveler)

- AVL maintains an equal volume level; even if you change channels.

1. Press the **MENU** button and then use **▲ / ▼** button to select the **SOUND** menu.
2. Press the **▶** button and then use **▲ / ▼** button to select **AVL**.
3. Press the **▶** button and then use **▲ / ▼** button to select **On** or **Off**.
4. Press the **ENTER** button to save.

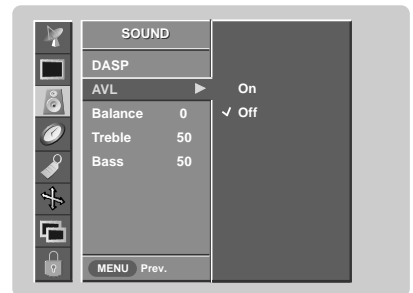

Manual Sound Control (**User** option)

- You can adjust sound treble, bass, and balance to the levels you prefer.

1. Press the **MENU** button and then use **▲ / ▼** button to select the **SOUND** menu.
2. Press the **▶** button and then use **▲ / ▼** button to select the desired sound option (**Balance, Treble, Bass**).
3. Press the **▶** button and then use **◀ / ▶** button to make appropriate adjustments.
4. Press the **ENTER** button to save.

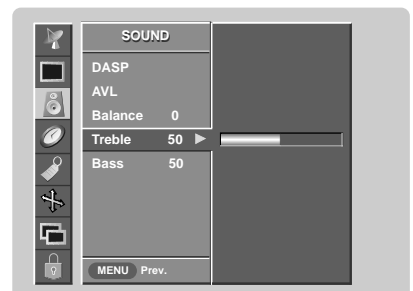

Stereo/SAP Broadcasts Setup

- The TV can receive MTS stereo programs and any SAP (Secondary Audio Program) that accompanies the stereo program, as the system to be transmitted one additional sound signal as well as the original one.
- Mono : The primary language is heard from left and right speakers. Signal mode is mono.
- Stereo : The primary language is heard from left and right speakers. Signal mode is stereo.
- SAP : The secondary language is heard from left and right speakers.

1. Press the **MTS** button repeatedly.



- Select mono sound mode if the signal is not clear or in poor signal reception areas.
- **Stereo, SAP** mode are available only if included on the broadcast signal.

Timer Menu Options

Auto Clock Setup

- The time is set automatically from the PBS broadcast signal.
 - The PBS channel signal includes information for the correct time and daylight saving time.
1. Press the **MENU** button and then use **▲ / ▼** button to select the **TIMER** menu.
 2. Press the **▶** button and then use **▲ / ▼** button to select **Clock**.
 3. Press the **▶** button and then use **▲ / ▼** button to select **Auto**.
 4. Press the **▶** button and then use **▲ / ▼** button to select your viewing area time zone. Your choices are: **E.S.T.** (Eastern Standard Time), **C.S.T.** (Central Standard Time), **M.S.T.** (Mountain Standard Time), **P.S.T.** (Pacific Standard Time), **Alaska**, or **Hawaii**.
 5. Press the **▶** button and then use **▲ / ▼** button to set **PBS channel**.
 6. Press the **▶** button and then use **▲ / ▼** button to set **D.S.T.** (Daylight Savings Time) **Auto**, **On**, or **Off** depending on whether or not your viewing area observes Daylight Savings Time.
 7. Press the **ENTER** button to save.



Manual Clock Setup

- If current time setting is not correct, set the clock manually.
1. Press the **MENU** button and then use **▲ / ▼** button to select the **TIMER** menu.
 2. Press the **▶** button and then use **▲ / ▼** button to select **Clock**.
 3. Press the **▶** button and then use **▲ / ▼** button to select **Manual**.
 4. Press the **▶** button and then use **▲ / ▼** button to set the hour.
 5. Press the **▶** button and then use **▲ / ▼** button to set the minutes.
 6. Press the **ENTER** button to save.

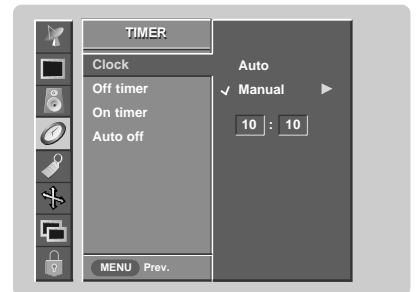

On/Off Timer Setup

- Timer function operates only if current time has been set.
- Off-Timer function overrides On-Timer function if they are set to the same time.
- The TV must be in standby mode for the On Timer to work.
- If you don't press any button within 2 hours after turning on the set with the On Timer function, the set will automatically switch back to standby mode.

1. Press the **MENU** button and then use **▲ / ▼** button to select the **TIMER** menu.
2. Press the **▶** button and then use **▲ / ▼** button to select **Off timer** or **On timer**.
3. Press the **▶** button and then use **▲ / ▼** button to select **On**.
 - To cancel **On/Off timer** function, select **Off**.
4. Press the **▶** button and then use **▲ / ▼** button to set the hour.
5. Press the **▶** button and then use **▲ / ▼** button to set the minutes.
6. **For only On timer function;** Press the **▶** button and then use **▲ / ▼** button to set sound level. Then, press the **▶** button and then use **▲ / ▼** button to select the channel at turn-on.
7. Press the **ENTER** button to save.



Timer Menu Options continued

Auto Off

- If there is no input signal, Auto off can be set to turn the TV off automatically after 10 minutes.

1. Press the **MENU** button and then use **▲ / ▼** button to select the **TIMER** menu.
2. Press the **▶** button and then use **▲ / ▼** button to select **Auto off**.
3. Press the **▶** button and then use **▲ / ▼** button to select **On** or **Off**.
4. Press the **ENTER** button to save.

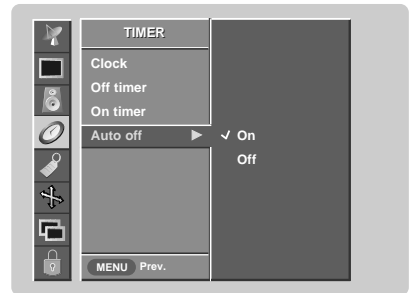

Sleep Timer

- Sleep Timer turns the TV off at a preset time. Note that this setting is cleared when the TV is turned off.

1. Press the **SLEEP** button repeatedly to select the number of preset minutes. First the **⌚ --- Min** option appears on the screen, followed by the following sleep timer turn off times: 10, 20, 30, 60, 90, 120, 180, and 240 minutes.
2. When the number of minutes you want is displayed on the screen, press the **ENTER** button. The timer begins to count down from the number of minutes selected.
3. To check the remaining minutes before the TV turns off, press the **SLEEP** or **ENTER** button once.
4. To cancel the Sleep Timer, press the **SLEEP** button repeatedly until **⌚ --- Min** appears.

Special Menu Options

Key Lock

- The TV can be set up so that it can only be used with the remote control.
- This feature can be used to prevent unauthorized viewing by locking out the front panel controls.
- This TV is programmed to remember which option it was last set to even if you turn the TV off.

1. Press the **MENU** button and then use ▲ / ▼ button to select the **SPECIAL** menu.
2. Press the ► button and then use ▲ / ▼ button to select **Key lock**.
3. Press the ► button and then use ▲ / ▼ button to select **On** or **Off**.
4. Press the **ENTER** button to save.

- With the KEY LOCK ON, the display '⚠ **Key lock**' appears on the screen if any button on the front panel is pressed.



ISM (Image Sticking Minimization) Method

- A frozen still picture from a PC/video game displayed on the screen for prolonged periods will result in an ghost image remaining; even when you change the image. Avoid allowing a fixed image to remain on the TV's screen for a long period of time.

1. Press the **MENU** button and then use ▲ / ▼ button to select the **SPECIAL** menu.
2. Press the ► button and then use ▲ / ▼ button to select **ISM method**.
3. Press the ► button and then use ▲ / ▼ button to select either **Normal**, **White wash**, **Orbiter** or **Inversion**.

• Normal

If image sticking is never a problem, ISM is not necessary - set to Normal.

• White wash

White Wash removes permanent images from the screen. Note: An excessive permanent image may be impossible to clear entirely with White Wash. To return to normal viewing, press the any button.

• Orbiter

Orbiter may help prevent ghost images. However, it is best not to allow any fixed image to remain on the screen. To avoid a permanent image on the screen, the image will move every 1 minutes: Right → Right → Downside → Downside → Left → Left → Upside → Upside.

• Inversion

Inversion will automatically invert the TV panel color every 30 minutes.

4. Press the **ENTER** button to save.

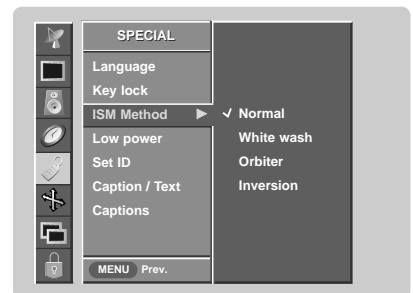

Low Power

- Low power reduces the TV power consumption.

1. Press the **MENU** button and then use ▲ / ▼ button to select the **SPECIAL** menu.
2. Press the ► button and then use ▲ / ▼ button to select **Low power**.
3. Press the ► button and then use ▲ / ▼ button to select **On** or **Off**.
 - When you select **On**, the screen darkens.
4. Press the **ENTER** button to save.

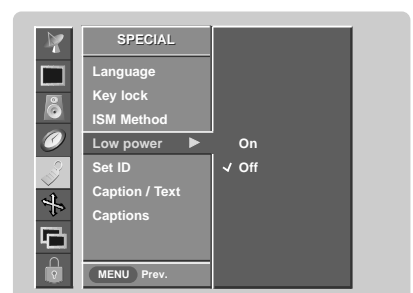

Special Menu Options continued

Closed Captions

Closed captioning is a process which converts the audio portion of a television program into written words which then appear as subtitles on the television screen. Closed captions allow viewers to read the dialogue and narration of television programs.

Using Closed Captions

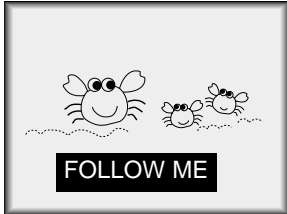

Captions are the subtitles of the dialogue and narration of television programs. For prerecorded programs, program dialogue can be arranged into captions in advance. Its possible to caption a live program by using a process called real-time captioning, which creates captions instantly. Real-time captioning is normally done by professional reporters using a machine shorthand system and computer for translation into English.

Captioning is an effective system for the hearing-impaired, and it can also aid in teaching language skills.

- The picture at left shows a typical caption.

Caption Tips

- Not all TV broadcasts include closed caption signals.
- Sometimes TV stations broadcast four different caption signals on the same channel. By selecting **From CC 1 to CC 4**, you can choose which signal you view. **CC 1** is usually the signal with the captions, while **Another mode** might show demonstration or programming information.
- Your TV might not receive caption signals normally in the following situations.

1. Poor reception conditions are encountered:



- **IGNITION:**
Picture may flutter, drift, suffer from black spots, or horizontal streaking. Usually caused by interference from automobile ignition systems, neon lamps, electrical drills, and other electrical appliances.



- **GHOSTS:**
Ghosts are caused when the TV signal splits and follows two paths. One is the direct path and the other is reflected off tall buildings, hills or other objects. Changing the direction or position of the antenna may improve reception.



- **SNOW:**
If your receiver is located at the weak, fringe area of a TV signal, your picture may be marred by small dots. It may be necessary to install a special antenna to improve the picture.

2. An old, bad, or illegally recorded tape is being played.
3. Strong, random signals from a car or airplane interfere with the TV signal.
4. The signal from the antenna is weak.
5. The program wasn't captioned when it was produced, transmitted, or taped.

Caption/Text

1. Press the **MENU** button and then use **▲ / ▼** button to select the **SPECIAL** menu.
2. Press the **▶** button and then use **▲ / ▼** button to select **Caption/Text**.
3. Press the **▶** button and then use **▲ / ▼** button to select your caption selection.
Your choices are: **CC1, CC2, CC3, CC4, Text 1, Text 2, Text3** and **Text4**.
4. Press the **ENTER** button to save.



Captions

1. Press the **CAPTION** button repeatedly to select **Off**, **On**, or **EZ mute**

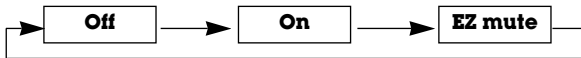

- You can also adjust **Captions** in the **SPECIAL** menu.
- **Ez mute** shows the selected captions option (if available on program) when the TV sound is muted.

Screen Menu Options

Auto Adjustment

- RGB (PC) mode only; This function doesn't work for RGB-DTV mode.
- Automatically adjusts picture position and minimizes image shaking.
- After adjustment, if the image is still not correct, your TV is functioning properly but needs further adjustment.
- **Auto config.** and **Manual config.** are not active in DVI mode.

1. Press the **MENU** button and then use **▲ / ▼** button to select the **SCREEN** menu.
2. Press the **▶** button and then use **▲ / ▼** button to select **Auto config.**.
3. Press the **▶** button to run Auto configure.
 - When **Auto config.** has finished, **OK** will be shown on screen.
 - If the position of the image is still not correct, try Auto adjustment again.
4. In RGB (PC) mode, if the image needs to be adjusted more after using **Auto config.**, you can make further adjustments with the **Manual config.** option.

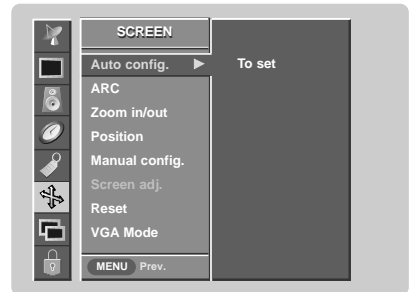

Setting Picture Format

- Caution: If a 4:3 fixed image is on the screen for a long time, it may remain visible.
- Set every aspect ratio for RGB 480p, DVI 480p, Component 480i/480p, Video, and S-Video sources.
- Use 4:3, or 16:9 for other input sources.

1. Press the **ARC** button repeatedly to select the desired picture format. You can also adjust **ARC** in the **SCREEN** menu.
 - **4:3**
 - Choose **4:3** when you want to view a picture with an original 4:3 aspect ratio, with gray bars appearing at both the left and right sides.
 - **16:9**
 - Choose **16:9** when you want to adjust the picture horizontally, in a linear proportion to fill the entire screen.
 - **Horizon**
 - Choose **Horizon** when you want to adjust the picture in a non-linear proportion, that is, more enlarged at both sides, to create a spectacular view.
 - **Zoom**
 - Choose **Zoom** when you want to view the picture without any alteration. However, the top and bottom portions of the picture will be cropped.

Picture Size Zoom

- When enlarging or reducing the picture, the image may become distorted.

1. Use **ZOOM+/ZOOM-** button to enlarge or reduce the picture size.
 - Zoom adjustment range is 100~300.
2. Adjust the main picture position using the **▲ / ▼ / ◀ / ▶** buttons while in enlarged picture mode.

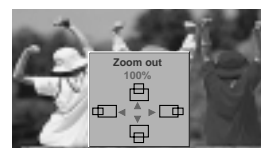

Adjusting Horizontal/ Vertical Position

- This function works in the following mode:
RGB-PC, RGB-DTV (480p,720p,1080i), COMPONENT (480p,720p,1080i).
1. Press the **MENU** button and then use **▲ / ▼** button to select the **SCREEN** menu.
 2. Press the **▶** button and then use **▲ / ▼** button to select **Position**.
 3. Press the **▶** button and then use **▲ / ▼ / ◀ / ▶** button to adjust the position.
 4. Press the **ENTER** button to save.

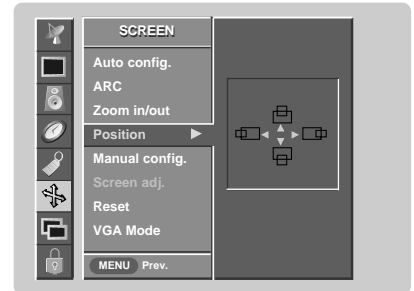

Manual Configure (RGB-PC mode only)

- If the image still isn't clear after auto adjustment and especially if characters are still jittery, adjust the picture Phase manually.
 - To correct the screen size, adjust **Clock**.
1. Press the **MENU** button and then use **▲ / ▼** button to select the **SCREEN** menu.
 2. Press the **▶** button and then use **▲ / ▼** button to select **Manual config.**
 3. Press the **▶** button and then use **▲ / ▼** button to select **Phase** or **Clock**.
 4. Use the **◀ / ▶** button to make appropriate adjustments.
 - The **Phase** adjustment range is 0 ~ 31.
 - The **Clock** adjustment range is -50 ~ +50.
 5. Press the **ENTER** button to save.

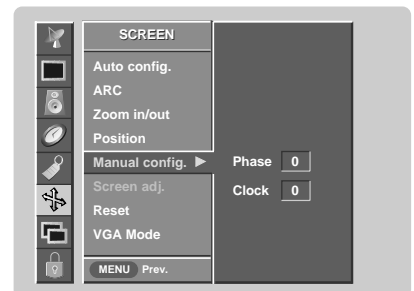

Screen Adjustments (TV, Video(Exp.), Video, S-Video and Component 480i mode only)

- Use this function to correct jittering or picture instability while viewing a video tape.
1. Press the **MENU** button and then use **▲ / ▼** button to select the **SCREEN** menu.
 2. Press the **▶** button and then use **▲ / ▼** button to select **Screen adj.**
 3. Press the **▶** button and then use **▲ / ▼** button to select **TV** or **VCR**.
 - Select the **VCR** option if watching a VCR.
 - Select the **TV** option for other equipment. (Except VCR)
 4. Press the **ENTER** button to save.

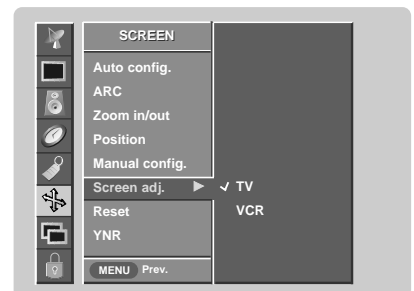

Initializing (Reset to original factory value)

- This function operates in every mode.
 - Use the Reset option to initialize the adjusted settings.
1. Press the **MENU** button and then use **▲ / ▼** button to select the **SCREEN** menu.
 2. Press the **▶** button and then use **▲ / ▼** button to select **Reset**.
 3. Press the **▶** button.
 - You can initialize Zoom in/out, Manual config., Position, Split zoom, PIP size, PIP position and sub picture size for double window.

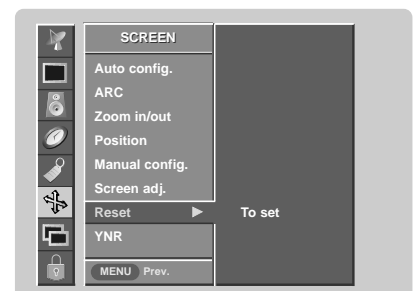

Screen Menu Options continued

Luminance Noise Reduction (TV, Video(Exp.), Video, S-Video and Component 480i modes only)

- Use YNR to reduce the picture noise that may appear on the screen.
1. Press the **MENU** button and then use **▲ / ▼** button to select the **SCREEN** menu.
 2. Press the **▶** button and then use **▲ / ▼** button to select **YNR**.
 3. Press the **▶** button and then use **▲ / ▼** button to select **On** or **Off**.
 4. Press the **ENTER** button to save.

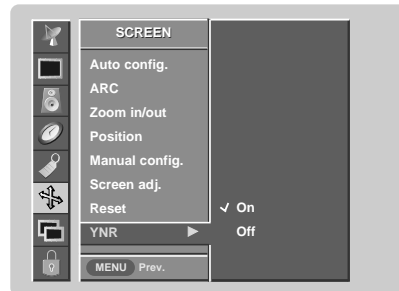

Selecting Wide VGA mode (RGB-PC, DVI-PC mode only)

- To see a normal picture, match the resolution of RGB mode and selection of VGA mode.

1. Press the **MENU** button and then use **▲ / ▼** button to select the **SCREEN** menu.
2. Press the **▶** button and then use **▲ / ▼** button to select **VGA mode**.
3. Press the **▶** button and then use **▲ / ▼** button to select the desired VGA resolution.
4. Press the **ENTER** button to save.

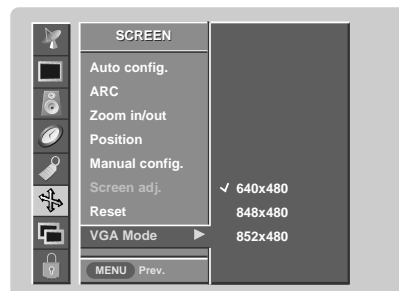

Split Zoom

- Enlarges the picture in correct proportions.
- Split Zoom can be used for all input sources.
- In 2-Split Zoom mode, you can only move the image up or down.
- If an image is enlarged, a section can be viewed without using Split Zoom.
- Split Zoom is not available if **OSD rotate** is **rotate**.

1. Press the **SPLIT ZOOM** button repeatedly to select either 2, 4, or 9 Split Zoom.

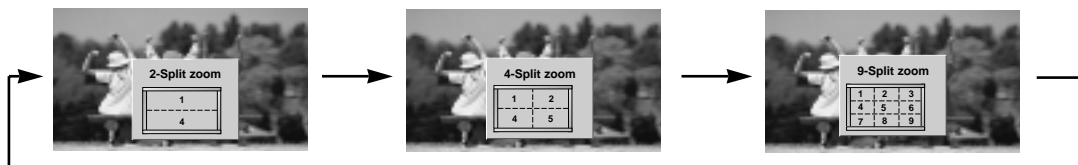

2. Press the number button corresponding to the section you wish to enlarge. You can move within the enlarged picture using the **▲ / ▼ / ◀ / ▶** button.



Example of choosing 5.



Section 5 is enlarged to fill the screen.

PIP (Picture-In-Picture) Feature

- PIP lets you view 2 different inputs pictures (sources) on your monitor screen at the same time. One source will be large, and the other source will show a smaller inset image.
- PIP is not available if the **lock on/off** option in **LOCK** menu is set to **On**.
- You can also adjust the PIP features in the PIP/DW menu (Except Swap function).

Watching PIP

Press the **PIP** button repeatedly to turn PIP on or off.



Swapping the PIP

Press the **SWAP** button to exchange the main and sub pictures.

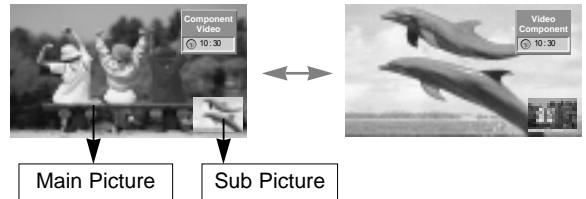

Moving the PIP

Press the **WIN.POSITION** button.

Press the **▲ / ▼ / ◀ / ▶** button repeatedly until desired position is achieved. The sub picture moves up/down/left/right.

You can also move the PIP position with **Win.position** in the **PIP/DW** menu.



TV Program Selection for PIP

Press the **PIP CH ▲ / PIP CH ▼** button to select a channel for the sub picture in PIP mode.

Selecting an Input Signal Source for the PIP

Use the **PIP INPUT** button to select the input source for the sub picture.

Main Picture Source	Available Sub Picture Sources
TV	Video (Exp.), Video, S-Video, Component 480i/480p/720p/1080i, RGB and DVI
Video (Exp.)	TV, Video, S-Video, Component 480i/480p/720p/1080i, RGB and DVI
Video	TV, Video (Exp.), S-Video, Component 480i/480p/720p/1080i, RGB and DVI
S-Video	TV, Video (Exp.), Video, Component 480i/480p/720p/1080i, RGB and DVI
Component 480i	TV, Video (Exp.), RGB, DVI, Video and S-Video
Component 480p/720p/1080i	TV, Video (Exp.), Video and S-Video
RGB and DVI	TV, Video (Exp.), Video, S-Video, Component 480i

PIP Aspect Ratio

- Press the **WIN.SIZE** button and then use **◀ / ▶** button to change the sub picture size.



- To watch 4:3 or 16:9 aspect ratio for sub picture

1. Press the **MENU** button and then use **▲ / ▼** button to select the **PIP/DW** menu.
2. Press the **▶** button and then use **▲ / ▼** button to select **PIP ARC**.
3. Press the **▶** button and then use **▲ / ▼** button to select **4:3** or **16:9**.
4. Press the **ENTER** button to save.

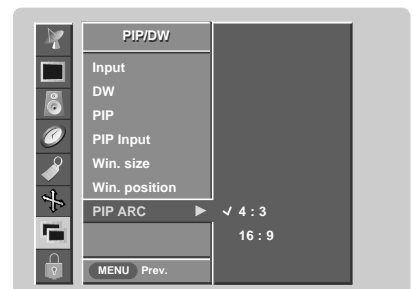

Double Window Setup Options

- As the name suggests, this mode splits the screen into 2, allowing 2 picture sources to be shown on the TV screen at the same time. Each source is given half the screen.
- Double Window is not available if the **lock on/off** option in **LOCK** menu is set to **On**.

Watching the Double Window

Press the **DW** button repeatedly to select one of the Double Window options.



Sub Picture Size Adjustment

Press the **WIN.SIZE** button.

- Use the ◀ / ▶ button to change the sub picture size.
- Using the Win.size function in Double Window mode, main and sub picture sizes are changed simultaneously.
Using the Win.size function in PIP mode, sub picture size is changed.
- Win.position is not functional in Double Window mode.



Swapping the Double Window

Use the **SWAP** button to switch the main and sub pictures in Double Window mode.

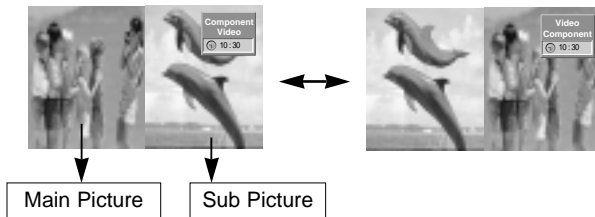

Selecting a Source for the Double Window

Use the **PIP INPUT** button to select the input source for the sub picture. You can also select **PIP Input** in the **PIP/DW** menu.

Main Picture Source	Available Sub Picture Sources
TV	Video (Exp.), Video, S-Video, Component 480i/480p/720p/1080i, RGB and DVI
Video (Exp.)	TV, Video, S-Video, Component 480i/480p/720p/1080i, RGB and DVI
Video	TV, Video (Exp.), S-Video, Component 480i/480p/720p/1080i, RGB and DVI
S-Video	TV, Video (Exp.), Video, Component 480i/480p/720p/1080i, RGB and DVI
Component 480i	TV, Video (Exp.), RGB, DVI, Video and S-Video
Component 480p/720p/1080i	TV, Video (Exp.), Video and S-Video
RGB and DVI	TV, Video (Exp.), Video, S-Video, Component 480i

Lock Menu Options

Parental Control can be used to block specific channels, ratings and other viewing sources. The password will be required to gain access to Parental Control.

The Parental Control Function (V-Chip) is used to block program viewing based on the ratings sent by the broadcasting station. The default setting is to allow all programs to be viewed. Viewing can be blocked by the type of program and by the categories chosen to be blocked. It is also possible to block all program viewing for a time period. To use this function, the following must be set :

1. Ratings and categories to be blocked.
2. Specifying a password
3. Enabling the lock

V-Chip rating and categories

Rating guidelines are provided by broadcasting stations. Most television programs and television movies can be blocked by TV Rating and/or Individual Categories. Movies that have been shown at the theaters or direct-to-video movies use the Movie Rating System (MPAA) only.

For Movies previously shown in theaters:

Movie Ratings :

- Blocking off
- G (general audience)
- PG (parental guidance suggested)
- PG-13 (13 years and up)
- R (restricted)
- NC-17 (18 years and up)
- X (adult)

If you set PG-13 and Above : G and PG movies will be available , PG-13, R, NC-17 and X will be blocked.

For Television programs including made-for-TV movies :

General TV Ratings :

- Blocking off
- TV-G (general audience) (individual categories do not apply)
- TV-PG (parental guidance suggested)
- TV-14 (14 years and up)
- TV-MA (mature audience)

Children TV Ratings :

- Blocking off
- TV-Y (youth) (individual content categories do not apply)
- TV-Y7 (youth, 7 years and up)

Content Categories :

- Dialog - sexual dialogue (applies to TV-PG, TV-14)
- Language - adult language (applies to TV-PG, TV-14, TV-MA)
- Sex scenes - sexual situations (applies to TV-PG, TV-14, TV-MA)
- Violence (applies to TV-PG, TV-14, TV-MA)
- F Violence - fantasy violence (applies only to TV-Y7)
- No Rating (blocks all viewing)

Aux.Block Ratings :

- Video (Exp.) (Blocking On/off)
- Video (Blocking On/off)
- S-Video (Blocking On/off)

For Canadian English/French language rating system:

Canadian English language rating system:

- C (Children)
- C8+ (8 years and up)
- G (General programming. Suitable for all audiences.)
- PG (Parental guidance suggested)
- 14+ (Viewer 14 years and up)
- 18+ (Adult programming)

Canadian French language rating system:

- G (General)
- 8 ans+ (8 years and up)
- 13 ans+ (13 years and up)
- 16 ans+ (16 years and up)
- 18 ans+ (Adults only)

Lock Menu Options continued

Lock setup

- Select TV, Video (Exp.), Video, or S-video input source to use this function.
1. Press the **MENU** button and then use **▲ / ▼** button to select the **Lock** menu. Then, press the **▶** button.
 - If **Lock** is already set, enter the password then requested.
 - The TV is set with the initial password "0-0-0-0".
 2. **Setting lock on/off:**

Press the **▲ / ▼** button to select **Lock on/off**.

Press the **▶** button and then use **▲ / ▼** button to select **on** or **off**.
 3. **Set password:**

Press the **▲ / ▼** button to select **Set password**.

Press the **▶** button and then enter a four digit password.
Enter it again when requested.
 4. Press the **▲ / ▼** button to select type of blocking to be set.
 5. Press the **▶** button and then use **▲ / ▼** button to select type of ratings to block.
 - **Age block**, **Content block**, and **Canadian opt.** options, also have sub menus. So repeat step 4 to 5 in the sub menu, to set the types of blocking and rating.



External Control Device Setup

- Connect the RS-232C input jack to an external control device (such as a computer or an A/V control system) and control the TV's functions externally.
- Connect the serial port of the control device to the RS-232C jack on the TV back panel.
- RS-232C connection cables are not supplied with the TV.

RS-232C Setup

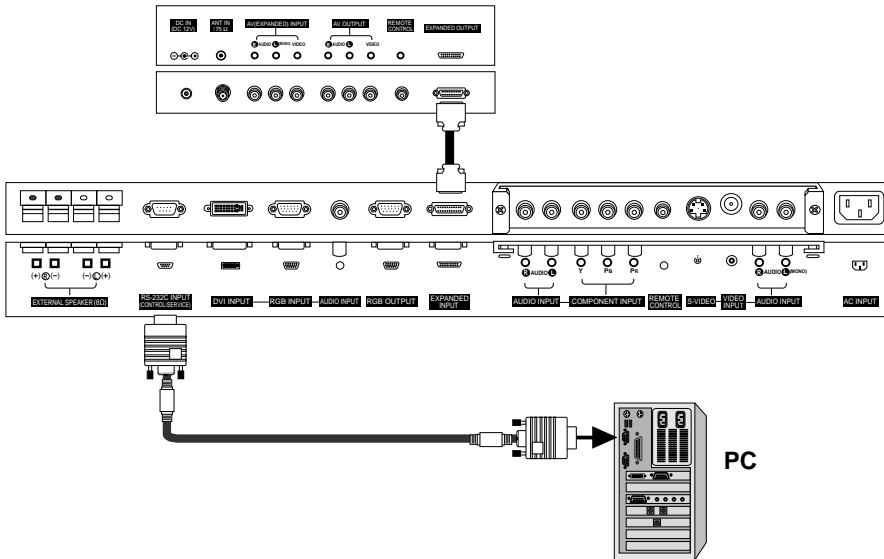

Type of Connector; D-Sub 9-Pin Male

No.	Pin name
1	No connection
2	RXD (Receive data)
3	TXD (Transmit data)
4	DTR (DTE side ready)
5	GND
6	DSR (DCE side ready)
7	RTS (Ready to send)
8	CTS (Clear to send)
9	No Connection

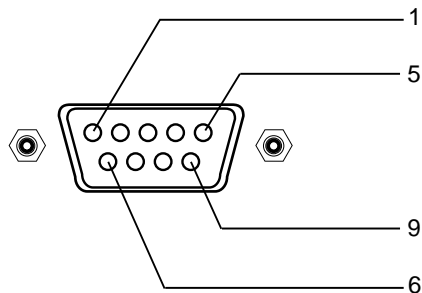

RS-232C Configurations

7-Wire Configurations (Standard RS-232C cable)

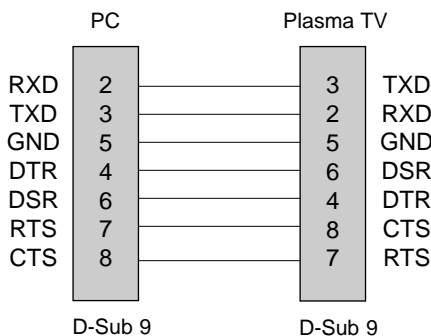

3-Wire Configurations (Not standard)

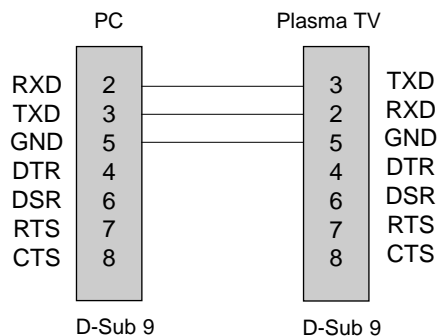

Set ID

- Use this function to specify a TV ID number.
- Refer to 'Real Data Mapping 1'. See page 35.

1. Press the **MENU** button and then use **▲ / ▼** button to select the **SPECIAL** menu.
2. Press the **▶** button and then use **▲ / ▼** button to select **Set ID**.
3. Press the **▶** button and then use **◀ / ▶** button to adjust **Set ID** to choose the desired TV ID number. The adjustment range of **Set ID** is 1 ~ 99.
4. Press the **ENTER** button to save.



Communication Parameters

- Baud rate : 115200 bps (UART)
- Data length : 8 bits
- Parity : None
- Stop bit : 1 bit
- Communication code : ASCII code

* Use a crossed (reverse) cable.

Command Reference List

	COMMAND 1	COMMAND 2	DATA (Hexadecimal)
01. Power	k	a	0 ~ 1
02. Input Select	k	b	0 ~ 6
03. Aspect Ratio	k	c	0 ~ 3
04. Screen Mute	k	d	0 ~ 1
05. Volume Mute	k	e	0 ~ 1
06. Volume Control	k	f	0 ~ 64
07. Contrast	k	g	0 ~ 64
08. Brightness	k	h	0 ~ 64
09. Color	k	i	0 ~ 64
10. Tint	k	j	0 ~ 64
11. Sharpness	k	k	0 ~ 64
12. OSD Select	k	l	0 ~ 1
13. Remote Control Lock Mode	k	m	0 ~ 1
14. PIP/DW	k	n	0 ~ 3
15. PIP Aspect Ratio	k	o	0 ~ 1
16. Split Zoom	k	p	21 ~ 99
17. PIP Position	k	q	0 ~ 3
18. Treble	k	r	0 ~ 64
19. Bass	k	s	0 ~ 64
20. Balance	k	t	0 ~ 64
21. Color Temperature	k	u	0 ~ 3
22. Red Adjustment	k	v	0 ~ C8
23. Green Adjustment	k	w	0 ~ C8
24. Blue Adjustment	k	\$	0 ~ C8
25. PIP Input Source	k	y	0 ~ 6
26. Abnormal State	k	z	0 ~ a
27. ISM Method	j	p	0 ~ 3
28. Low Power	j	q	0 ~ 1
29. Orbiter Time Setting	j	r	1 ~ FE
30. Orbiter Pixel Setting	j	s	0 ~ 9
31. Picture Size Setting for Double Window mode	j	t	0 ~ 64
32. Auto Configure	j	u	1

- Menu doesn't display on screen when setting the 4, 12, 13, and 26 ~ 32.

Transmission / Receiving Protocol

Transmission

[Command1][Command2][][Set ID][][Data][Cr]

- * [Command 1]: First command to control the TV. (j or k)
- * [Command 2]: Second command to control the TV.
- * [Set ID]: You can adjust the set ID to choose desired TV ID number in Special menu. Adjustment range is 1 ~ 99. When selecting Set ID '0', every connected the TV is controlled. Set ID is indicated as decimal (1~99) on menu and as Hexa decimal (0x0~0x63) on transmission/receiving protocol.
- * [DATA]: To transmit command data.
Transmit 'FF' data to read status of command.
- * [Cr]: Carriage Return
ASCII code '0x0D'
- * []: ASCII code 'space (0x20)'

OK Acknowledgement

[Command2][][Set ID][][OK][Data][x]

- * The TV transmits ACK (acknowledgement) based on this format when receiving normal data. At this time, if the data is data read mode, it indicates present status data. If the data is data write mode, it returns the data of the PC computer.

Error Acknowledgement

[Command2][][Set ID][][NG][Data][x]

- * The TV transmits ACK (acknowledgement) based on this format when receiving abnormal data from non-viable functions or communication errors.

- Data
- 1: Illegal Code
 - 2: Not supported function
 - 3: Wait more time

08. Brightness (Command2:h)

- ▶ To adjust screen brightness.
You can also adjust brightness in the Video menu.

Transmission

[k][h][][Set ID][][Data][Cr]

Data Min : 0 ~ Max : 64

- Refer to 'Real data mapping 1'. See page 35.

Acknowledgement

[h][][Set ID][][OK][Data][x]

09. Color (Command2:i)

- ▶ To adjust the screen color.
You can also adjust color in the Video menu.

Transmission

[k][i][][Set ID][][Data][Cr]

Data Min : 0 ~ Max : 64

- Refer to 'Real data mapping 1'. See page 35.

Acknowledgement

[i][][Set ID][][OK][Data][x]

10. Tint (Command2:j)

- ▶ To adjust the screen tint.
You can also adjust tint in the Video menu.

Transmission

[k][j][][Set ID][][Data][Cr]

Data Red : 0 ~ Green : 64

- Refer to 'Real data mapping 1'. See page 35.

Acknowledgement

[j][][Set ID][][OK][Data][x]

11. Sharpness (Command2:k)

- ▶ To adjust the screen sharpness.
You can also adjust sharpness in the Video menu.

Transmission

[k][k][][Set ID][][Data][Cr]

Data Min: 0 ~ Max: 64

- Refer to 'Real data mapping 1'. See page 35.

Acknowledgement

[k][][Set ID][][OK][Data][x]

12. OSD Select (Command2:l)

- ▶ To select OSD (On Screen Display) on/off.

Transmission

[k][l][][Set ID][][Data][Cr]

Data 0: OSD off 1: OSD on

Acknowledgement

[l][][Set ID][][OK][Data][x]

13. Remote Control Lock Mode (Command2:m)

- ▶ To lock the remote control and the front panel controls on the TV.

Transmission

[k][m][][Set ID][][Data][Cr]

Data 0: Lock off 1: Lock on

Acknowledgement

[m][][Set ID][][OK][Data][x]

- If you're not using the remote control and front panel controls on the monitor, use this mode. When main power is on/off, remote control lock is released.

14. PIP / DW (Command2:n)

- ▶ To control the PIP (Picture In picture)/DW (Double Window).
You can also control the PIP/DW using the PIP or DW button on the remote control or in the PIP/DW menu.

Transmission

[k][n][][Set ID][][Data][Cr]

Data 0: PIP/DW off 2: DW1
1: PIP 3: DW2Acknowledgement

[n][][Set ID][][OK][Data][x]

15. PIP Aspect Ratio (Command2:o)

- ▶ To select the PIP picture format.
You can also select the PIP picture format using WIN.SIZE on the remote control.

Transmission

[k][o][][Set ID][][Data][Cr]

Data 0: 4:3 1: 16:9

Acknowledgement

[o][][Set ID][][OK][Data][x]

16. Split Zoom (Command2:p)

- ▶ To operate split zoom function and select the split zoom section number.

Transmission

[k][p][][Set ID][][Data][Cr]

Data Min: 21 ~ Max: 99

- Refer to 'Real data mapping 2'.

Acknowledgement

[p][][Set ID][][OK][Data][x]

*** Real data mapping 2**

21: Selection 1 of 2 split zoom
24: Selection 4 of 2 split zoom
41: Selection 1 of 4 split zoom
42: Selection 2 of 4 split zoom
44: Selection 4 of 4 split zoom
45: Selection 5 of 4 split zoom
91: Selection 1 of 9 split zoom
⋮
99: Selection 9 of 9 split zoom

17. PIP Position (Command2:q)

- ▶ To select sub picture position for PIP.
You can also adjust the sub picture position using WIN.POSITION on the remote control or in the PIP/DW menu.

Transmission

[k][q][][Set ID][][Data][Cr]

Data 0: Right down on screen
1: Left down on screen
2: Left up on screen
3: Right up on screen

Acknowledgement

[q][][Set ID][][OK][Data][x]

18. Treble (Command2:r)

- ▶ To adjust treble.
You can also adjust treble in the Audio menu.

Transmission

[k][r][][Set ID][][Data][Cr]

Data Min: 0 ~ Max: 64
• Refer to 'Real data mapping 1'. See page 35.

Acknowledgement

[r][][Set ID][][OK][Data][x]

19. Bass (Command2:s)

- ▶ To adjust bass.
You can also adjust bass in the Audio menu.

Transmission

[k][s][][Set ID][][Data][Cr]

Data Min: 0 ~ Max: 64
• Refer to 'Real data mapping 1'. See page 35.

Acknowledgement

[s][][Set ID][][OK][Data][x]

20. Balance (Command2:t)

- ▶ To adjust balance.
You can also adjust balance in the Audio menu.

Transmission

[k][t][][Set ID][][Data][Cr]

Data Min: 0 ~ Max: 64
• Refer to 'Real data mapping 1'. See page 35.

Acknowledgement

[t][][Set ID][][OK][Data][x]

21. Color Temperature (Command2:u)

- ▶ To adjust color temperature.
You can also adjust ACC in the Video menu.

Transmission

[k][u][][Set ID][][Data][Cr]

Data 0: Normal 1: Cool 2: Warm 3: User

Acknowledgement

[u][][Set ID][][OK][Data][x]

22. Red Adjustment (Command2:v)

- ▶ To adjust red in color temperature.

Transmission

[k][v][][Set ID][][Data][Cr]

Data Min: 0 ~ Max: C8
• Refer to 'Real data mapping 3' as shown below.

Acknowledgement

[v][][Set ID][][OK][Data][x]

23. Green Adjustment (Command2:w)

- ▶ To adjust green in color temperature.

Transmission

[k][w][][Set ID][][Data][Cr]

Data Min: 0 ~ Max: C8
• Refer to 'Real data mapping 3' as shown below.

Acknowledgement

[w][][Set ID][][OK][Data][x]

24. Blue Adjustment (Command2:\$)

- ▶ To adjust blue in color temperature.

Transmission

[k][\$][][Set ID][][Data][Cr]

Data Min: 0 ~ Max: C8
• Refer to 'Real data mapping 3' as shown below.

Acknowledgement

[\$][][Set ID][][OK][Data][x]

*** Real data mapping 3**

0 : -20
5 : -19
A : -18
⋮
5F: -1
64: 0
69: +1
⋮
C3: +19
C8: +20

25. PIP Input Select (Command2:y)

- ▶ To select input source for sub picture in PIP mode.

Transmission

```
[k][y][ ][Set ID][ ][Data][Cr]
```

Data 0 : RGB 4 : DVI
 1 : Component 5 : TV
 2 : Video 6 : Video (Exp.)
 3 : S-Video

Acknowledgement

```
[y][ ][Set ID][ ][OK][Data][x]
```

26. Abnormal State (Command2:z)

- ▶ To recognize an abnormal state.

Transmission

```
[k][z][ ][Set ID][ ][FF][Cr]
```

Data FF:Read

Acknowledgement

```
[z][ ][Set ID][ ][OK][Data][x]
```

Data 0: Normal (Power on and signal exist)
 1: No signal (Power on)
 2: Turn the monitor off by remote control
 3: Turn the monitor off by sleep time function
 4: Turn the monitor off by RS-232C function
 5: 5V down
 6: AC down
 7: Turn the monitor off by Fan Alarm function
 8: Turn the monitor off by off time function
 9: Turn the monitor off by auto off function
 a: Turn the monitor off by AV board detect

27. ISM Method (Command2:p)

- ▶ To avoid having a fixed image remain on screen.

Transmission

```
[j][p][ ][Set ID][ ][Data][Cr]
```

Data 0: Normal 2: Orbiter
 1: White wash 3: Inversion

Acknowledgement

```
[p][ ][Set ID][ ][OK][Data][x]
```

28. Low Power (Command2:q)

- ▶ To control the low power function on/off.

Transmission

```
[j][q][ ][Set ID][ ][Data][Cr]
```

Data 0: Low power off
 1: Low power on

Acknowledgement

```
[q][ ][Set ID][ ][OK][Data][x]
```

29. Orbiter Time Setting (Command2:r)

- ▶ To adjust orbiter operation time term.

Transmission

```
[i][r][ ][Set ID][ ][Data][Cr]
```

Data Min: 1 ~ Max: FE

Acknowledgement

```
[r][ ][Set ID][ ][OK][Data][x]
```

30. Orbiter Pixel Setting (Command2:s)

- ▶ To adjust pixel number in orbiter function.

Transmission

```
[j][s][ ][Set ID][ ][Data][Cr]
```

Data Min: 0 ~ Max: 9

Acknowledgement

```
[s][ ][Set ID][ ][OK][Data][x]
```

31. Picture Size Setting for Double Window mode (Command2:t)

- ▶ To adjust main window size in Double Window mode.

Transmission

```
[j][t][ ][Set ID][ ][Data][Cr]
```

Data Min: 0 ~ Max: 64

- Refer to 'Real data mapping1'. See page 35.

Acknowledgement

```
[t][ ][Set ID][ ][OK][Data][x]
```

32. Auto Configure (Command2:u)

- ▶ To adjust picture position and minimize image shaking automatically. It works only in RGB (PC) mode.

Transmission

```
[j][u][ ][Set ID][ ][Data][Cr]
```

Data 1: To set

Acknowledgement

```
[u][ ][Set ID][ ][OK][Data][x]
```

IR Code

How to Connect

- ▶ Connect your wired remote control to the Remote control port on the TV.

Remote Control IR Code

▶ Output waveform

Single pulse, modulated with 37.917KHz signal at 455KHz

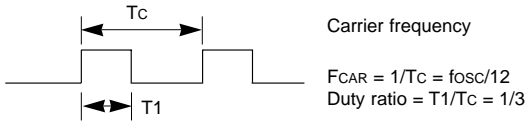

▶ Configuration of frame

- 1st frame

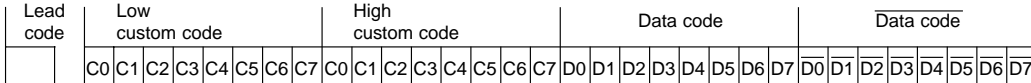

- Repeat frame

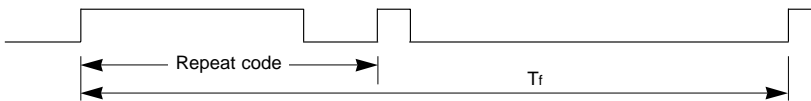

▶ Lead code



▶ Repeat code

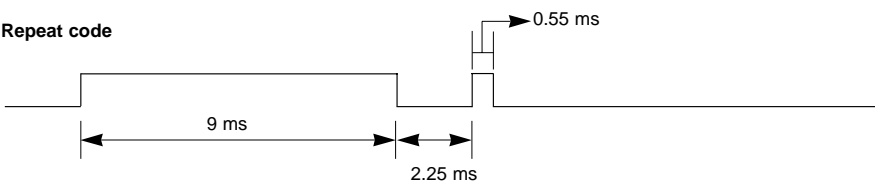

▶ Bit description

- Bit "0"

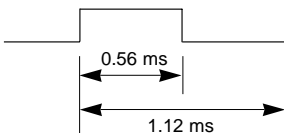

- Bit "1"

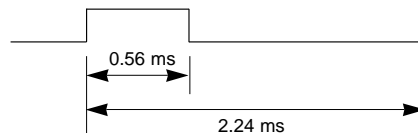

▶ Frame interval : Tf

The waveform is transmitted as long as a key is depressed.

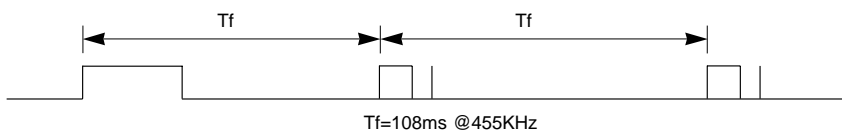

IR Code continued

Code (Hexa)	Function	Note
00H	UP (▲)	R/C Button
01H	DOWN (▼)	R/C Button
02H	VOL+ (▶)	R/C Button
03H	VOL- (◀)	R/C Button
08H	POWER ON/OFF	R/C Button (Power On/Off)
C4H	POWER ON	Discrete IR Code (Only Power On)
C5H	POWER OFF	Discrete IR Code (Only Power Off)
09H	MUTE	R/C Button
10H	Number Key 0	R/C Button
11H	Number Key 1	R/C Button
12H	Number Key 2	R/C Button
13H	Number Key 3	R/C Button
14H	Number Key 4	R/C Button
15H	Number Key 5	R/C Button
16H	Number Key 6	R/C Button
17H	Number Key 7	R/C Button
18H	Number Key 8	R/C Button
19H	Number Key 9	R/C Button
0BH	INPUT SELECT	R/C Button (Video/S-video/Component/RGB/DVI)
98H	MULTIMEDIA	R/C Button (Component/RGB/DVI)
D5H	RGB	Discrete IR Code (Input RGB Selection)
C6H	DVI	Discrete IR Code (Input DVI Selection)
BFH	Component	Discrete IR Code (Input Component Selection)
5AH	Video	Discrete IR Code (Input Video Selection)
D8H	S-video	Discrete IR Code (Input S-video Selection)
D6H	TV	Discrete IR Code (Input TV Selection)
D0H	Video (Exp.)	Discrete IR Code (Input Expanded Video Selection)
0EH	SLEEP	R/C Button
44H	ENTER (■)	R/C Button
43H	MENU	R/C Button
52H	DASP	R/C Button
4DH	APC	R/C Button
60H	PIP	R/C Button
61H	PIP INPUT	R/C Button
63H	SWAP	R/C Button (PIP/DW picture Exchange)
64H	PIP ARC	R/C Button (4:3/16:9)
6BH	DOUBLE WINDOW	R/C Button
40H	ZOOM +	R/C Button
41H	ZOOM -	R/C Button
69H	Window Size	R/C Button
6AH	Window Position	R/C Button
7BH	Split Zoom	R/C Button
79H	ARC	R/C Button (4:3/16:9/Zoom mode Selection)
76H	ARC (4:3)	Discrete (Only 4:3 mode)
77H	ARC (16:9)	Discrete (Only 16:9 mode)
AFH	ARC (Zoom)	Discrete (Only Zoom mode)
99H	AUTO CONFIG	Discrete IR Code
54H	AUTO PROGRAM	R/C Button
55H	MEMORY/ERASE	R/C Button
1EH	FAVORITE CH	R/C Button
39H	CAPTION	R/C Button
0AH	MTS	R/C Button
71H	PIP UP (▲)	R/C Button
72H	PIP DOWN (▼)	R/C Button

Troubleshooting Checklist

No picture & No sound

- Check whether the TV is turned on.
- Power cord inserted into wall outlet?
- Test the wall power outlet, plug other product's power cord into the wall outlet where the TV's power cord was plugged in.

Picture OK & No sound

- Press the **VOLUME** (▶) button.
- Sound muted? Press **MUTE** button.

The remote control doesn't work

- Check to see if there is any object between the TV and the remote control causing obstruction.
- Are batteries installed with correct polarity (+ to +, - to -)? (Refer to p.9)
- Install new batteries. (Refer to p.9)

Picture appears slowly after switching on

- This is normal as the image is muted during the startup process of the TV. Please contact your service center, if the picture has not appeared after five minutes.

No or Poor color or Poor picture

- Select **COLOR** in the **PICTURE** menu and press the **VOLUME** (▶) button. (Refer to p.19)
- Keep a sufficient distance between the TV and the VCR.
- Activate any function to restore the brightness of the picture. (If still picture is on the screen for more than 5 minutes, the screen gets dark.)

Horizontal/vertical bars or picture shaking

- Check for local interference such as an electrical appliance or power tool.

Troubleshooting Checklist continued

No output from one of the speakers

- Adjust **BALANCE** in the **SOUND** menu. (Refer to p.20)

Unusual sound from inside the TV

- A change in ambient humidity or temperature may result in an unusual noise when the TV is turned on or off and does not indicate a fault with the TV.

Lines or streaks in picture

- Check antenna (Change the direction of the antenna).

Poor stereo sound

- Check the kind of input signal and select **Mono**, **Stereo** or **SAP** with the **MTS** button.

Auto programming doesn't stop

- Press the **ENTER** button again.

Maintenance

- Early malfunctions can be prevented. Careful and regular cleaning can extend the amount of time you will have your new TV. Be sure to turn the power off and unplug the power cord before you begin any cleaning.

Cleaning the Screen

1. Here's a great way to keep the dust off your screen for a while. Wet a soft cloth in a mixture of lukewarm water and a little fabric softener or dish washing detergent. Wring the cloth until it's almost dry, and then use it to wipe the screen.
2. Make sure the excess water is off the screen, and then let it air-dry before you turn on your TV.

Cleaning the Cabinet

To remove dirt or dust, wipe the cabinet with a soft, dry, lint-free cloth. Please be sure not to use a wet cloth.

Extended Absence



If you expect to leave your TV dormant for a long time (such as a vacation), it's a good idea to unplug the power cord to protect against possible damage from lightning or power surges.

Product Specifications

MODEL	P42W34, P42W34H
Width (inches / mm)	48.9 / 1241
Height (inches / mm)	31.6 / 801.5
Depth (inches / mm)	4.4 / 111.7
Weight (pounds / kg)	77.2 / 35
Power requirement	AC100-240V ~ 50/60Hz
Television System	NTSC
Program Coverage	VHF 2 ~ 13, UHF 14 ~ 69, CATV 1 ~ 125
Resolution	852 x 480 (Dot)
Color	16,770,000 (256 steps of each R, G and B)
Operating Temperature Range	32 ~ 104°F (0 ~ 40°C)
Operating Humidity Range	Less than 80%
Maximum Elevation	6561 feet (2000m)

- The specifications shown above may be changed without notice for quality improvement.

Notes

Notes

ZENITH ELECTRONICS CORPORATION
PLASMA TV P42W34 & P42W34H LIMITED WARRANTY – USA

Zenith will repair or replace your product, at Zenith's option, if it proves to be defective in material or workmanship under normal use, during the warranty period ("Warranty Period") listed below, effective from the date of original consumer/end user purchase. This warranty is good only to the original consumer/end user of the product and is effective only when used in the United States.

<p><u>WARRANTY PERIOD:</u></p> <p>LABOR: ONE YEAR from the Date of Purchase.</p> <p>PARTS: ONE YEAR from the Date of Purchase.</p> <p>Effective Date of Warranty: Your warranty period Begins on the date of sale to the original consumer/end user. KEEP THE DEALER'S DATED BILL OF SALE OR PROOF OF DELIVERY as evidence of the purchase date. You will be required to submit a legible copy of your bill of sale or proof of delivery when requesting warranty service.</p> <p>Repair Parts and Replacement Units are warranted for the remaining period of the original warranty.</p>	<p><u>HOW SERVICE IS HANDLED:</u></p> <p>In Home Service. Please Call the Zenith Interactive Center at 1-877-9ZENITH (1-877-993-6484) to schedule a service appointment.</p> <p>Your unit will be repaired or replaced with a new, substitute model or factory reconditioned unit, at Zenith's option. If repaired, parts used in the repair may be new or remanufactured.</p> <p>Visit our website at http://www.zenithservice.com</p>
--	--

THIS WARRANTY IS IN LIEU OF ANY OTHER WARRANTIES, EXPRESS OR IMPLIED, INCLUDING WITHOUT LIMITATION, ANY WARRANTY OF MERCHANTABILITY OR FITNESS FOR A PARTICULAR PURPOSE. TO THE EXTENT ANY IMPLIED WARRANTY IS REQUIRED BY LAW, IT IS LIMITED IN DURATION TO THE EXPRESS WARRANTY PERIOD ABOVE. ZENITH WILL NOT BE LIABLE FOR ANY INCIDENTAL, CONSEQUENTIAL, INDIRECT, SPECIAL, OR PUNITIVE DAMAGES OF ANY NATURE, INCLUDING, WITHOUT LIMITATION, LOST PROFITS, LOST OR CORRUPTED PROGRAMMING OR DATA, OR ANY OTHER DAMAGE WHETHER BASED IN CONTRACT, TORT, OR OTHERWISE. Some states do not allow the exclusion or limitation of incidental or consequential damages or limitations on how long an implied warranty lasts, so the above exclusion or limitation may not apply to you. This warranty gives you specific legal rights and you may also have other rights that vary from state to state.

THIS LIMITED WARRANTY DOES NOT APPLY TO:

<ul style="list-style-type: none"> ● damage caused in shipping or transit ● service required as a result of improper installation, including incorrect or insufficient AC supply (please consult the owner's manual for power supply requirements) ● installation or repair of antenna systems, cable converters, cable company supplied equipment, or other components in a video system ● set-up or adjustment on consumer controls, or damage caused by improper adjustments ● damage caused by other system components ● any unit that has been modified or incorporated into any other product ● replacement of batteries on the remote control. ● damage (including cosmetic damage), failure, loss 	<p>or personal injury due to misuse, abuse, negligence, improper maintenance or storage, or to acts of nature or other causes beyond Zenith's control. (Causes beyond Zenith's control include but are not limited to lightning strike, power surges, power outages and water damage.)</p> <ul style="list-style-type: none"> ● Image burn-in ● repair or replacement of warranted parts by other than Zenith Authorized Service Centers. ● units purchased or serviced outside of the U.S.A. ● product where the original factory serial numbers have been removed, defaced or changed in any way. ● product sold and labeled as "as is, where is" or similar disclaimer.
---	---

The costs of repair or replacement under these excluded circumstances shall be borne by the consumer.

CONCERNING PIXEL FUNCTIONALITY: Your Plasma Television contains about one million individual pixels. Plasma TVs typically contain a small number of pixels that do not function normally. Your display has been inspected and is in compliance with manufacturer's specifications, indicating that any pixel defects do not affect the operation or use of your display.

CUSTOMER INTER-ACTIVE CENTER NUMBERS:

<p>To obtain customer assistance, product information, or Dealer or Service locations</p>	<p>Call 1-877-9Zenith (1-877-993-6484) (Monday - Friday, 7 AM - 8 PM CT; and Saturday, 8 AM - 5 PM CT) and select appropriate options from the menu. Or visit our website at http://www.zenithservice.com</p>
--	---

BEFORE CALLING FOR SERVICE:

- Please check your operating guide – you may avoid a service call.
- Please have your product model number, serial number and the date of purchase or the date of original installation available.
- If a replacement unit is required, under some circumstances you may be asked to provide a reserve deposit to Zenith against a credit card number as surety for advanced shipment. Your credit card will not be charged if you return the defective unit within 10 working days.
- If a replacement unit is received, please use the carton and packaging from that unit in returning the defective unit to Zenith.
- Parts and service in accordance with the Zenith warranty are Zenith's responsibility and will be provided without charge. Other service requirements will be at the owner's expense. If you have problems in obtaining satisfactory warranty service, write or call the Zenith Customer Interactive Center. Service may be provided by independently owned and operated service organizations.
- To assure proper credit and avoid unnecessary charges, you must obtain a Return Authorization before returning any product for Zenith Warranty Service. Contact the number below or your authorized Zenith repair facility for details.

IMPORTANT: Please fill out and mail your Product Registration Card or go to www.zenithservice.com to register your product online. This information allows Zenith to reach you promptly should we discover a safety or reliability problem that could affect you.

TO CONTACT ZENITH BY MAIL:

Zenith Customer Interactive Center
P.O. Box 240007
201 James Record Road
Huntsville, AL 35824
ATTN: CIC Plasma TV, Building 3

Free Manuals Download Website

<http://myh66.com>

<http://usermanuals.us>

<http://www.somanuals.com>

<http://www.4manuals.cc>

<http://www.manual-lib.com>

<http://www.404manual.com>

<http://www.luxmanual.com>

<http://aubethermostatmanual.com>

Golf course search by state

<http://golfingnear.com>

Email search by domain

<http://emailbydomain.com>

Auto manuals search

<http://auto.somanuals.com>

TV manuals search

<http://tv.somanuals.com>