

Z2179-93110

ZENOAH
KOMATSU
BRUSHCUTTER
OPERATOR'S MANUAL

BC340DLM
BC340DWM

FOR SAFE OPERATION

1. Read this manual carefully until you completely understand and can follow all safety notes, precautions, and operating instructions before starting use of the unit.
2. Do not operate this tool when you are tired, ill, or under the influence of alcohol, drugs, or medication.
3. Use protection gears for your eyes and ears.
4. Always wear long pants, boots, and gloves. Do not wear loose clothing, jewelry, short pants, or go barefoot.
5. Never start or run the engine inside a closed room or building. Exhaust gases contain dangerous carbon monoxide.
6. Before starting the engine, inspect the entire unit for loose fasteners and fuel leakage. Make sure that the cutting attachment is properly installed and securely fastened.
7. Be sure the blade guard is attached in place.
8. Fuel is highly flammable. Always keep open flames and sparks away from the unit and fuel depot. Do not smoke while refueling the unit or mixing fuel.
9. When refueling the unit, make sure to stop the engine and allow it to cool down. Wipe spilled fuel completely from the unit. Move at least 3 meters away from fueling site before starting the engine.
10. Check the condition of working area to avoid any accident by hitting hidden obstacles such as stumps, stones, cans, or broken grass.
11. Keep bystanders and animals at least 15 meters away from the operating point. If you are approached, immediately stop the engine.
12. Keep firm footholds and balance at all times. Do not use the unit where footing is unsteady or slippery.
13. Keep cutting attachment below waist level.
14. Keep all parts of your body away from the rotating cutting attachment and hot surfaces.
15. A sharp reaction of the unit may occur when spinning blade contacts an object that it cannot cut. To avoid losing control, always keep a firm grip on the unit with both hands, and watch for rocks, woods, or metal poles behind weeds.
16. When inspecting or servicing the unit, make sure to stop the engine and disconnect the spark plug as necessary.
17. Cover the blade when the transporting or storing the unit.
18. When replacing cutting attachment or other components, be sure to use the parts supplied or recommended by Komatsu Zenoh.

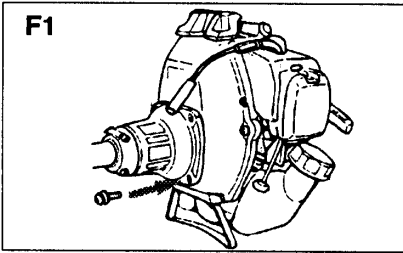

F1

ENGINE

1. Using attached 4 socket screws, secure the connection firmly with equal force. (F1)
2. Pry open the joint case by using the tip of a screwdriver, and connect the throttle cable(F2). After connecting the switch wires, put the protection tube onto the cable and wires.

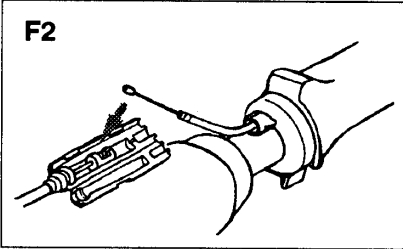

F2

FRONT HANDLE

- Put the handle onto the main pipe and fix it with 3 screws. (F3)

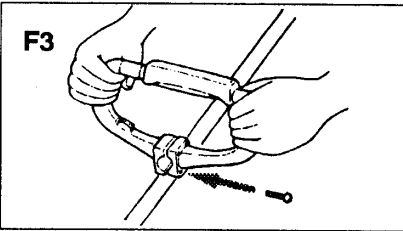

F3

BLADE GUARD

- Attach the guard to the bracket on the main pipe and fix it with 4 screws and nuts. (F4)

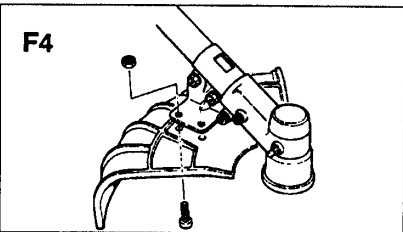

F4

BLADE

1. Put the angled bar(F5-1) into the side holes of the inner holder and the gearcase.
2. Remove the blade bolt(F5-2, Left-handed) and the outer holder (F5-3) from the gearshaft.
3. Put the blade onto the inner holder(F5-4). Make the marked side face the holder.
4. Put the outer holder onto the gearshaft making the recessed side face the blade.
5. Fasten the blade by the blade bolt with the washers(F5-5) and the bolt cover(F5-6).

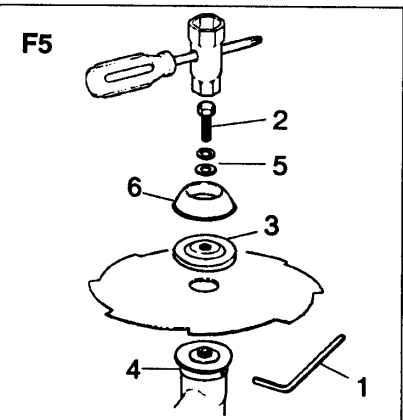

F5

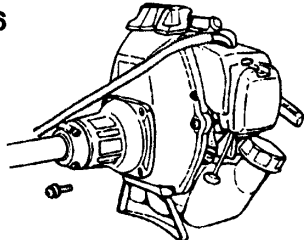
F6**ENGINE**

Using attached 4 socket screws, secure the connection firmly with equal force. (F6)

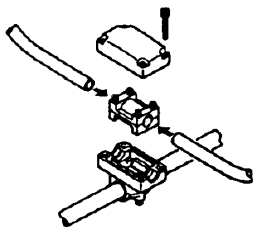
F7**HANDLE**

1. Remove the upper cap from the bracket.
2. Loosen the 4 bolts on the clamp and insert the handles equally. Retighten the bolts.
3. Put the handle assembly into the bracket and put the upper cap over it. Tighten the cap securely. (F7)
4. Remove the screw (F8-1) from the right grip (F8-2) and put the grip onto the right handle. Align the positioning holes and put the screw through them. Fasten the clamp (F8-3).

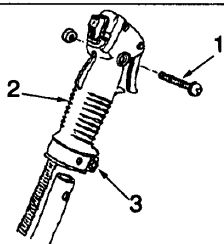
F8**PROTECTOR**

Wrap the protector around the outer pipe as shown in the figure (F9), and fasten the hooks.

F9**BLADE GUARD**

Attach the guard to the bracket on the main pipe and fix it with 4 screws and nuts (F10).

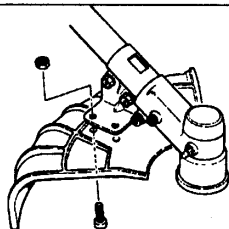
F10**BLADE**

1. Put the angled bar (F11-1) into the side holes of the inner holder and the gearcase.
2. Remove the blade bolt (F11-2, Left-handed) and the outer holder (F11-3) from the gearshaft.
3. Put the blade onto the inner holder (F11-4). Make the marked side face the holder.
4. Put the outer holder onto the gearshaft making the recessed side face the blade.
5. Fasten the blade by the blade bolt with the washers (F11-5) and the bolt cover (F11-6).

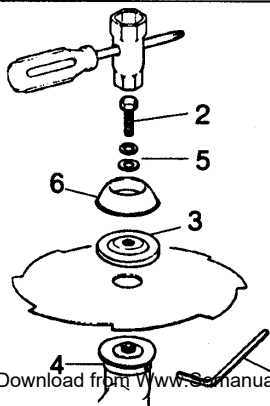
F11

FUEL



- Keep open flames away from the area where fuel is handled or stored.
- Mix and store fuel only in an approved gasoline container.

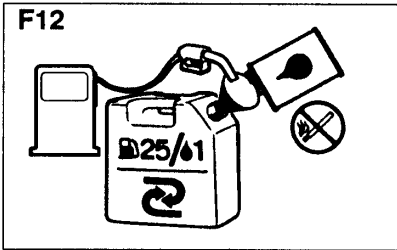

Mix a regular grade gasoline (leaded or unleaded, alcohol-free) and a quality-proven motor oil for air cooled 2-stroke gasoline engine use.

Recommended mixing ratio:

Term	Gasoline: Oil
Upto 20 use hours	20 : 1
After 20 use hours	25 : 1

25 : 1 Mix Chart

Gasoline liter	1	2	3	4	5
2-cycle oil ml.	40	80	120	160	200

NOTE: Most engine troubles are caused, directly or indirectly, by the fuel used on the machine. Take special care not to mix a motor oil for 4-stroke engine use.

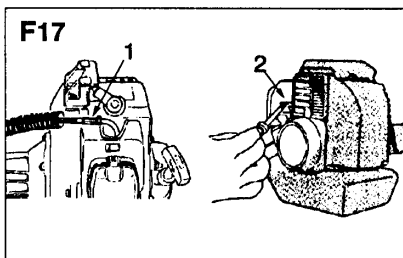
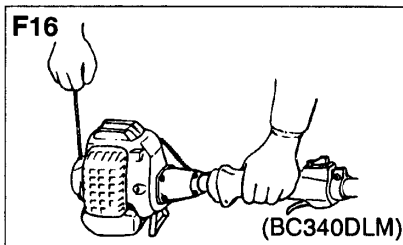
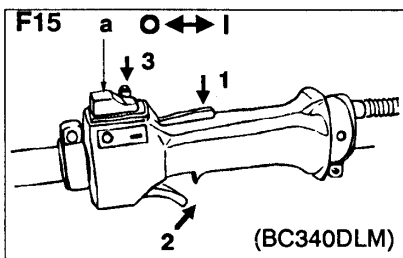
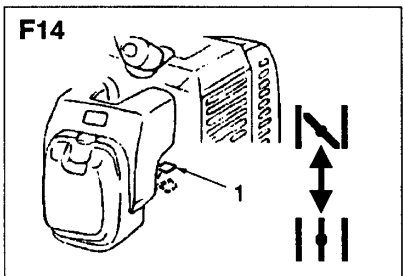
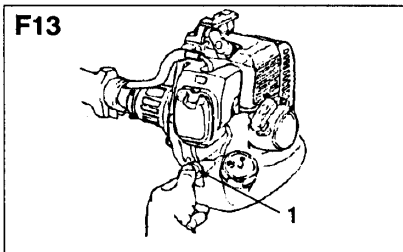

STARTING THE ENGINE



Take care that the cutting head will start rotating upon the engine starts.

1. Push the primer pump (F13-1) several times until overflow fuel flows out in the clear tube.
2. Move the choke lever (F14-1) to the closed position.
3. Set the engine switch (F15-a) to the " I " position. Set the throttle lever to the start position (F15, 1-2-3).
4. Place the unit on a flat, firm place. Keep the cutting head clear of everything around it.
5. While holding the unit firmly, pull out the starter rope quickly. (F16)
6. After the engine has started, open the choke gradually and allow the engine to warm up. Pull the throttle lever to unlock it.

STOPPING THE ENGINE

1. Release the throttle lever.
2. Move the engine switch to the " O " position.

ADJUSTMENTS

Throttle cable: The normal play is 1 or 2 mm when measured at the carburetor side end. Readjust with the cable adjuster (F17-1) as required.

Engine idling speed: It is normal that the engine keeps running without the blade rotation, when the throttle lever is released. When the engine speed is too high or too slow, readjust the idle set screw (F17-2).

■ CUTTING WORK

F18



- By using the shoulder strap, hang the unit on your right side. Adjust the strap length so that the cutting head may become parallel to the ground. (F18)

- Choose a suitable attachment according to the object to be cut. (F19)

F19

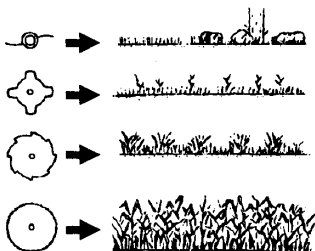

- When using a metal blade:

a) Use the front left side for cutting.

b) Guide the blade from your right to left with it tilted slightly to your left. (F20)

c) When mowing a wide area, start working from your left end to avoid interference of cut grass.

d) The blade may be seized by weeds if the engine speed is too low, or the blade cuts too deep into weeds. Adjust the engine speed and cutting depth according to the condition of object.

F20

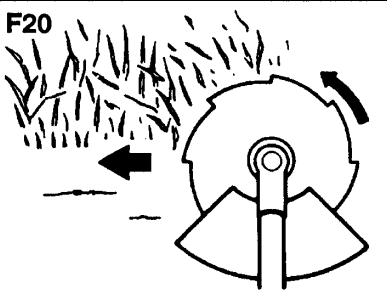

- When using a nylon line head:

a) Guide the head from your left to right to let the cut grass be thrown away from you. (F21)

b) Always do cutting with the engine running at full throttle.

c) Use only the tip of the line for cutting, and allow it to trim at its own pace.

F21

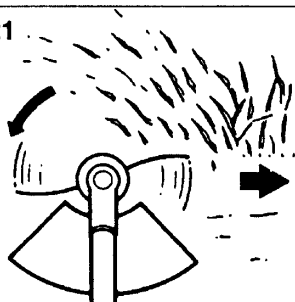



Before cleaning, inspecting, or repairing the unit, make sure that the engine has stopped and is cool.

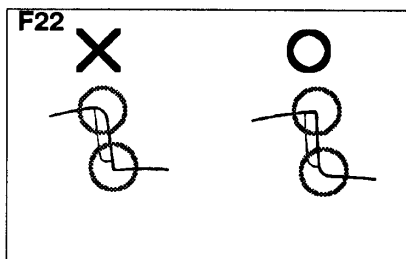

■ BLADE

- Check the blade and the fasteners for looseness, cracking, or bending.

- Check the cutting edges and re-form with a flat file.

Point(F22):

1. Keep the end corner sharp.
2. Round the root of the edge.
3. Do not use water when using a grinder.

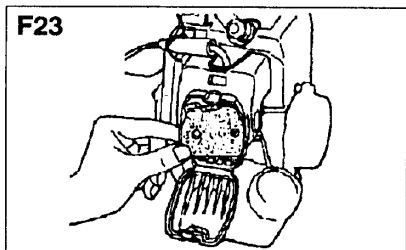

■ AIR FILTER(F23)

A clogged air filter will reduce the engine performance. Check periodically and clean the filter element in warm, soapy water as required. Dry completely before installing. If the element is broken or shrunk, replace with a new one.

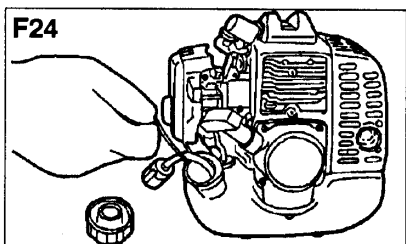

■ FUEL FILTER(F24)

When the engine runs short of fuel supply, check the fuel strainer for blockage.

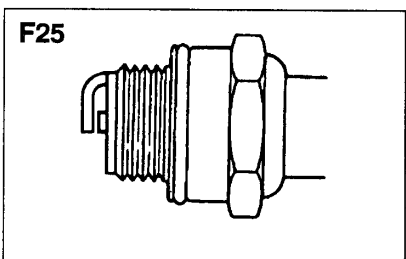

■ SPARK PLUG(F25)

Starting failure and mis-firing are often caused by a fouled spark plug. Periodically clean the spark plug, and replace with a new one as required.

Type of Plug	Spark Gap
Champion RCJ8Y	0.6 – 0.7 mm

F26

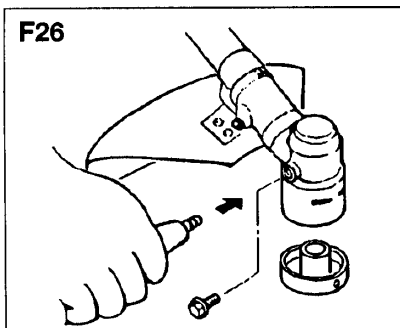

■ GEARCASE

Supply multi-purpose grease at every 25 hours of use.

1. Remove the cutter holders.
2. Charge grease until waste grease appears around the gear shaft. (F26)

■ MAINTENANCE BEFORE STORAGE

Old fuel left in the carburetor may cause starting failure. When a series of operation finished, make sure to empty the fuel tank and drain the carburetor.

SPECIFICATIONS

Model name	BC340DLM [BC340DWM]
Engine model Zenoah G3KD
Displacement 33.6 cc
Carburetor Diaphragm type
Ignition system I.C.controlled flywheel magneto
Spark plug Champion RCJ8Y
Fuel Mixture (Gasoline 25 : 2-cycle oil 1)
Fuel tank capacity 0.65 litres
Starter Recoil starter
Clutch Centrifugal type
Reduction ratio 1.235
Cutter rotation Counter-clockwise as viewed from operator
Overall dimensions(L × W × H) 1790 × 275 [630] × 335 [435] :mm
Dry weight 7.3 [7.7] kg

Specifications are subject to change without notice.

LIMITED WARRANTY

Should any failure occur on the product under normal operating conditions within the applicable warranty period, the failed part will be replaced or repaired at free of charge by Komatsu Zenoah authorized dealer.

WARRANTY PERIOD: 1 year (6 months if used professionally, and 30 days if used for rental purpose) from the date of initial purchase.

IMPORTANT: The following cases are not covered by this warranty:

- (a) Any failure resulted from neglect of instructions for proper operation and maintenance of the product described in the operator's manual.
- (b) Any damage due to accidents, abuse, negligence, alteration, or use of any parts or accessories other than those specified by Komatsu Zenoah.
- (c) Any failure due to use of improper fuel.
- (d) Replacement of normally consumed parts: cutter blades, spark plugs, filters, starter ropes, etc.
- (e) Regular maintenance and adjustments explained in the operator's manual.
- (f) Incidental or consequential damages.
- (g) Transportation charge for failed/repaired unit.

Nothing contained in this warranty affects the consumer's statutory rights.

Free Manuals Download Website

<http://myh66.com>

<http://usermanuals.us>

<http://www.somanuals.com>

<http://www.4manuals.cc>

<http://www.manual-lib.com>

<http://www.404manual.com>

<http://www.luxmanual.com>

<http://aubethermostatmanual.com>

Golf course search by state

<http://golfingnear.com>

Email search by domain

<http://emailbydomain.com>

Auto manuals search

<http://auto.somanuals.com>

TV manuals search

<http://tv.somanuals.com>