

ZENOAH
KOMATSU



OWNER'S MANUAL

BRUSHCUTTERS



BCZ4500DL / DW
BCZ5000DL / DW
BCZ4500 / 5000CL

▲ SAFETY FIRST

Instructions contained in warnings within this manual marked with a ▲ symbol concern critical points which must be taken into consideration to prevent possible serious bodily injury, and for this reason you are requested to read all such instructions carefully and follow them without fail.

WARNINGS IN THE MANUAL

▲ WARNING

This mark indicates instructions, which must be followed in order to prevent accidents, which could lead to serious bodily injury or death.

❗ IMPORTANT

This mark indicates instructions, which must be followed, or it leads to mechanical failure, breakdown, or damage.

📖 NOTE

This mark indicates hints or directions useful in the use of the product.

Contents

1. Parts location	2
2. Specifications	3
3. Warning labels on the machine	3
4. Symbols on the machine	3
5. For safe operation	4
6. Set up	7
7. Fuel	8
8. Operation	9
9. Maintenance	12
10. Storage	14
11. Troubleshooting guide	15

1. Parts location

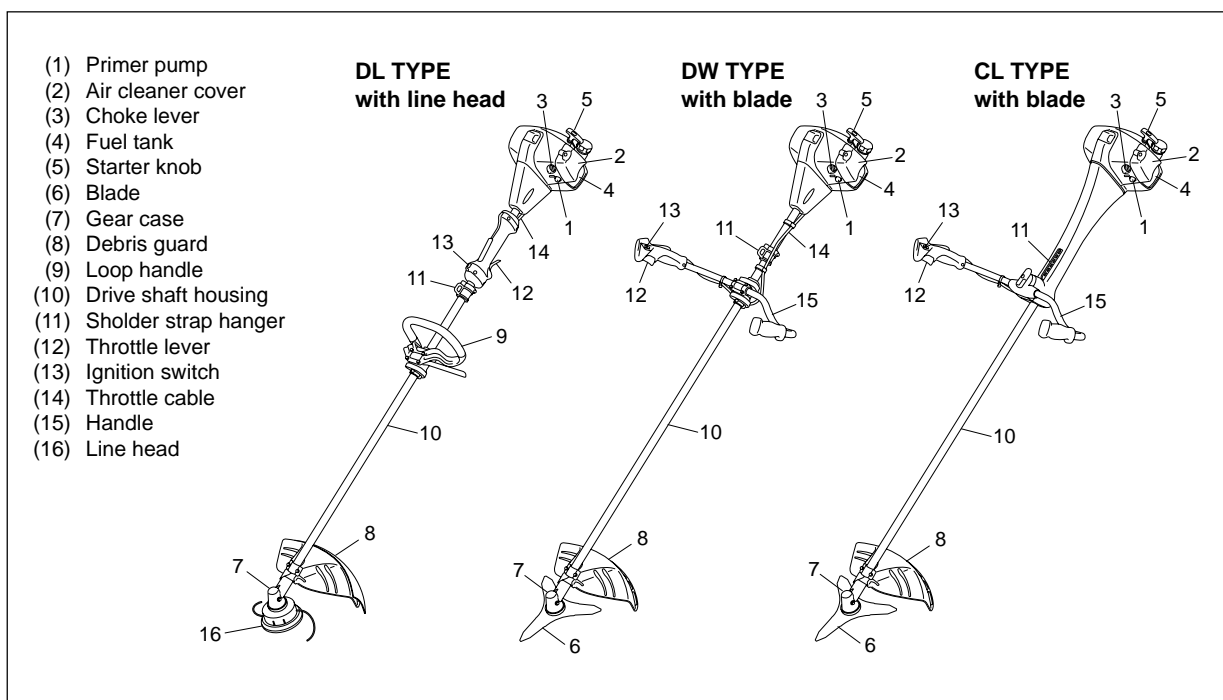

2. Specification

Model		BCZ4500DL/DW	BCZ5000DL/DW	BCZ4500/5000CL
Overall size (LxWxH)	mm	DL: 1915x420x260 DW: 1915x655x450		1915x655x530
Dry weight	kg	8.5		9.0
Engine	Model	Zenoah GZ45N	Zenoah GZ50N	Zenoah GZ45N/GZ50N
	Displacement	cm ³	45.2	50.6
	Fuel	Mixture (Gasoline 50 : Oil 1)*		
	Carburetor	Diaphragm type		
	Ignition system	Flywheel magneto (C.D.I.)		
	Spark plug	NGK CMR7H		
Fuel tank capacity	L	0.8		
Starter		Recoil starter		
Clutch		Centrifugal type		
Reduction ratio		1.4		
Cutting head rotating direction		Counter-clockwise (Operator view)		

*When using Zenoah genuine oil

Specifications are subject to change without notice.

3. Warning labels on the machine



Read owner's manual before operating this machine.



Wear head, eye and ear protection.



Warning / Attention

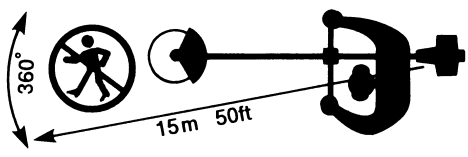

Keep all children, bystanders and helpers 15 meters away from the machine.



If warning label peels off or becomes soiled and impossible to read, you should contact the dealer from which you purchased the product to order new labels and affix them in the required location(s).



Never modify your machine.
We won't warrant the machine, if you use the remodeled brushcutter or if you don't observe the proper usage written in the manual.

4. Symbols on the machine

For safe operation and maintenance, symbols are carved in relief on the machine. According to these indications, please be careful not to make a mistake.
 The port to refuel the "MIX GASOLINE"



Position: FUEL TANK CAP



The direction to close the choke
Position: ENGINE COVER



The direction to open the choke
Position: ENGINE COVER

▲ 5. For safe operation



1. Read this manual carefully until you completely understand and follow all safety and operating instructions.
2. Keep this manual handy so that you may refer to it later whenever any questions arise. Also note, if you have any questions which cannot be answered herein, contact the dealer from whom you purchased the product.
3. Always be sure to include this manual when selling, lending, or otherwise transferring the ownership of this product.
4. Never allow children or anyone unable to fully understand the directions given in the manual to use the machine.



WORKING CONDITION

1. When using the product, you should wear proper clothing and protective equipment.

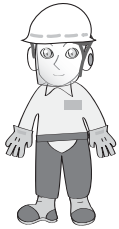

- (1) Helmet
- (2) Ear protectors
- (3) Protection goggles or face protector
- (4) Thick work gloves
- (5) Non-slip-sole work boots

2. And you should carry with you.
 - (1) Attached tools
 - (2) Properly reserved fuel
 - (3) Spare blade
 - (4) Things to notify your working area (rope, warning signs)
 - (5) Whistle (for collaboration or emergency)
 - (6) Hatchet or saw (for removal of obstacles)



3. Do not wear loose clothing, jewelry, short trousers, sandals, or go barefoot. Do not wear anything which might be caught by a moving part of the unit. Secure hair so it is above shoulder length.

WORKING CIRCUMSTANCE

1. Never start the engine inside a closed room or building. Exhaust gases contain dangerous carbon monoxide.
2. Never use the product,
 - a. when the ground is slippery or when you can't maintain a steady posture.



- b. At night, at times of heavy fog, or at any other times when your field of vision might be limited and it would be difficult to gain a clear view of the working area.
- c. During rain storms, during lightning storms, at times of strong or gale-force winds, or at any other times when weather conditions might make it unsafe to use the product.



WORKING PLAN

1. You should never use the product when under the influence of alcohol, when suffering from exhaustion or lack of sleep, when suffering from drowsiness as a result of having taken cold medicine or at any other time when a possibility exists that your judgment might be impaired or that you might not be able to operate the product properly and in a safe manner.
2. When planning your work schedule, allow plenty of time to rest. Limit the amount of time over which the product is to be used continuously to somewhere around 30 ~ 40 minutes per session, and take 10 ~ 20 minutes of rest between work sessions. Also try to keep the total amount of work performed in a single day under 2 hours or less.



▲ WARNING

1. If you don't observe the working time, or working manner (See "USING THE PRODUCT"), Repetitive Stress Injury (RSI) could occur.
If you feel discomfort, redness and swelling of your fingers or any other part of your body, see a doctor before getting worse.
2. To avoid noise complaints, in general, operate product between 8 a.m. and 5 p.m. on weekdays and 9 a.m. to 5 p.m. on weekends.



NOTE

Check and follow the local regulations as to sound level and hours of operations for the product.

▲ 5. For safe operation

BEFORE STARTING THE ENGINE



1. The area within a perimeter of 15 m (50 ft) of the person using the product should be considered a hazardous area into which no one should enter. If necessary, yellow warning rope, warning signs should be placed around the perimeter of the area. When work is to be performed simultaneously by two or more persons, care should also be taken to constantly look around or otherwise check for the presence and locations of other people working so as to maintain a distance between each person sufficient to ensure safety.
2. Check the condition of working area to avoid any accident by hitting hidden obstacles such as stumps, stones, cans, or broken glass.

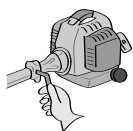

❗ IMPORTANT

Remove any obstacle before beginning work.

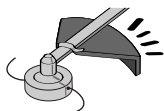

3. Inspect the entire unit for loose fasteners and fuel leakage. Make sure that the cutting attachment is properly installed and securely fastened.
4. Be sure the debris guard is firmly attached in place.
5. Always use the shoulder strap. Adjust the strap for comfort before starting the engine. The strap should be adjusted so the left hand can comfortably hold the handlebar grip approximately waist high.

STARTING THE ENGINE

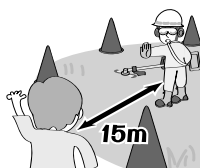

1. Keep bystanders and animals at least 15 m (50 ft) away from the operating point. If you are approached, immediately stop the engine.
2. The product is equipped with a centrifugal clutch mechanism, so the cutting attachment begins to rotate as soon as the engine is started by putting the throttle into the start position. When starting the engine, place the product onto the ground in a flat clear area and hold it firmly in place so as to



ensure that neither the cutting part nor the throttle come into contact with any obstacle when the engine starts.

▲ WARNING

Never place the throttle into the high-speed position when starting the engine.

3. After starting the engine, check to make sure that the cutting attachment stops rotating when the throttle is moved fully back to its original position. If it continues to rotate even after the throttle has been moved fully back, turn off the engine and take the unit to your authorized KOMATSU ZENOAH servicing dealer for repair.

USING THE PRODUCT

❗ IMPORTANT

Cut only materials recommended by the manufacturer. And use only for tasks explained in the manual.

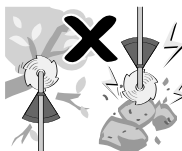

1. Grip the handles firmly with both hands using your whole hand. Place your feet slightly apart (slightly further apart than the width of your shoulders) so that your weight is distributed evenly across both legs, and always be sure to maintain a steady, even posture while working.
2. Keep cutting attachment below waist level.
3. Maintain the speed of the engine at the level required to perform cutting work, and never raise the speed of the engine above the level necessary.
4. If the unit starts to shake or vibrate, turn off the engine and check the whole unit. Do not use it until the trouble has been properly corrected.
5. Keep all parts of your body away from rotating cutting attachment and hot surfaces.
6. Never touch the muffler, spark plug, or other metallic parts of the engine while the engine is in operation or immediately after shutting down the engine. Doing so



▲ 5. For safe operation

could result in serious burns or electrical shock.

• IF SOMEONE COMES

1. Guard against hazardous situations at all times. Warn adults to keep pets and children away from the area. Be careful if you are approached. Injury may result from flying debris.
2. If someone calls out or otherwise interrupts you while working, always be sure to turn off the engine before turning around.



MAINTENANCE

1. In order to maintain your product in proper working order, perform the maintenance and checking operations described in the manual at regular intervals.
2. Always be sure to turn off the engine before performing any maintenance or checking procedures.

▲ WARNING

The metallic parts reach high temperatures immediately after stopping the engine.

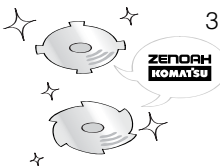

3. When replacing the cutting attachment or any other part, or when replacing the oil or any lubricant, always be sure to **use only KOMATSU ZENOAH products or products which have been certified by KOMATSU ZENOAH for use with the KOMATSU ZENOAH product.**
4. In the event that any part must be replaced or any maintenance or repair work not described in this manual must be performed, please contact a representative from the store nearest KOMATSU ZENOAH authorized servicing dealer for assistance.
5. Do not use any accessory or attachment other than those bearing the KOMATSU ZENOAH mark and recommended for the unit.
6. Under no circumstances should you ever take apart the product or alter it in any way. Doing so might result in the product becoming damaged during operation or the product becoming unable to operate properly.



HANDLING FUEL

1. The engine of the KOMATSU ZENOAH product is designed to run on a mixed fuel, which contains highly flammable gasoline. Never store cans of fuel or refill the tank of the unit in any place where there is a boiler, stove, wood fire, electrical sparks, welding sparks, or any other source of heat or fire which might ignite the fuel.
2. Never smoke while operating the unit or refilling its fuel tank.
3. When refilling the tank, always turn off the engine and allow it to cool down. Take a careful look around to make sure that there are no sparks or open flames anywhere nearby before refueling.
4. Wipe spilled fuel completely using a dry rag if any fuel spillage occurs during refueling.
5. After refueling, screw the fuel cap back tightly onto the fuel tank and then carry the unit to a spot 3 m or more away from where it was refueled before turning on the engine.

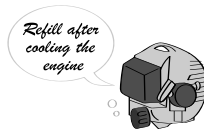

TRANSPORTATION

1. When hand-carrying the product, cover over the cutting part if necessary, lift up the product and carry it paying attention to the blade.
2. Never transport the product over rough roads over long distances by vehicle without removing all fuel from the fuel tank. If doing so, fuel might leak from the tank during transport.

6. Set up

INSTALLING HANDLE (BCZ4500DL/5000DL)

- Set the handle and the barrier on the bracket. Attach them with the 4bolts provided securely.

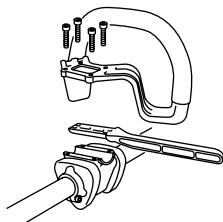

INSTALLING HANDLE (BCZ4500DW/5000DW)

- Loosen the 4bolts on the upper cap and insert the handle. Retighten the bolts securely.

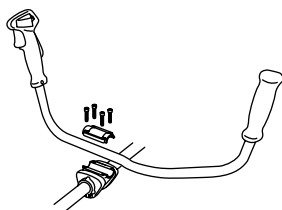

INSTALLING HANDLE (BCZ4500CL/5000CL)

- Loosen the handle knob to open the bracket and insert the handle. Retighten the knob securely.

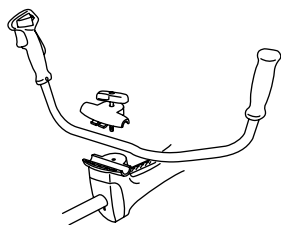

INSTALLING DEBRIS GUARD

- Attach the debris guard with the bolts provided to the shaft.

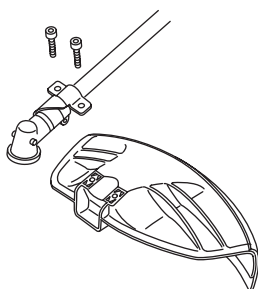

INSTALLING BLADE

- Put the angled bar(1) into the side holes of the inner holder and the gearcase.
- Remove the nut (Lefthanded) and the outer holder(3) from the gearshaft.
- Put the blade onto the inner holder(2). Make the marked side face the holder.
- Put the outer holder(3) onto the gearshaft making the recessed side face the blade.
- Fasten the blade by the nut and the cover(4).

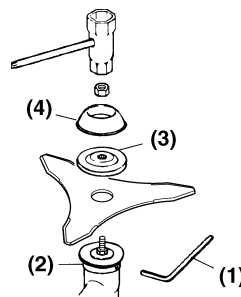

INSTALLING LINE HEAD

- While locking the gear shaft by inserting the supplied tool into the upper holder on the gear box, loosen and remove the nut (left-handed).
- Detach the cover(1), fit the line head assembly to the gear shaft. Hand tighten it securely.

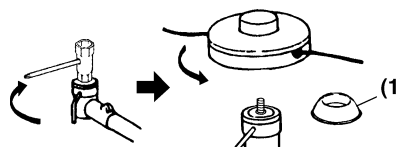

DEBRIS GUARD SKIRT FOR LINE HEAD

- When using line head, make sure to attach the guard skirt.

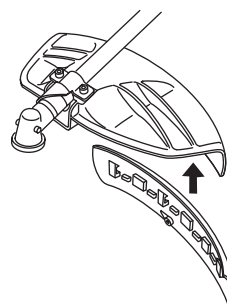

BALANCE UNIT

- Put on strap and attach unit to strap.
- Slide clamp up or down until unit balances with head aparting from the ground when using it.



7. Fuel

■ FUEL

⚠ WARNING

- **Gasoline is very flammable. Avoid smoking or bringing any flame or sparks near fuel. Make sure to stop the engine and allow it cool before refueling the unit. Select outdoor bare ground for fueling and move at least 3 m (10 ft) away from the fueling point before starting the engine.**



- The Komatsu Zenoah engines are lubricated by oil specially formulated for air-cooled 2-cycle gasoline engine use. If Komatsu Zenoah oil is not available, use an anti-oxidant added quality oil expressly labeled for air-cooled 2-cycle engine use (JASO FC GRADE OIL or ISO EGC GRADE).
- Do not use BIA or TCW (2-stroke water-cooling type) mixed oil.

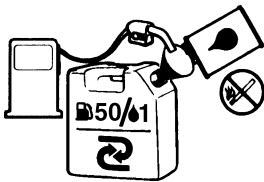

■ RECOMMENDED MIXING RATIO GASOLINE 50 : OIL 1 <when using Zenoah genuine oil>

- **Exhaust emission are controlled by the fundamental engine parameters and components (eq., carburation, ignition timing and port timing) without addition of any major hardware or the introduction of an inert material during combustion.**
- These engines are certified to operate on unleaded gasoline.
- Make sure to use gasoline with a minimum octane number of 89RON (USA/Canada: 87AL).
- If you use a gasoline of a lower octane value than prescribed, there is a danger that the engine temperature may rise and an engine problem such as piston seizing may consequently occur.
- Unleaded gasoline is recommended to reduce the contamination of the air for the sake of your health and the environment.
- Poor quality gasolines or oils may damage sealing rings, fuel lines or fuel tank of the engine.

■ HOW TO MIX FUEL

⚠ WARNING

- Pay attention to agitation.
1. Measure out the quantities of gasoline and oil to be mixed.
 2. Put some of the gasoline into a clean, approved fuel container.
 3. Pour in all of the oil and agitate well.
 4. Pour in the rest of gasoline and agitate again for at

least one minute. As some oils may be difficult to agitate depending on oil ingredients, sufficient agitation is necessary for the engine to last long. Be careful that, if the agitation is insufficient, there is an increased danger of early piston seizing due to abnormally lean mixture.

5. Put a clear indication on the outside of the container to avoid mixing up with gasoline or other containers.
6. Indicate the contents on outside of container for easy identification.

■ FUELING THE UNIT

1. Untwist and remove the fuel cap. Rest the cap on a dustless place.
2. Put fuel into the fuel tank to 80% of the full capacity.
3. Fasten the fuel cap securely and wipe up any fuel spillage around the unit.

⚠ WARNING

1. Select bare ground for fueling.
2. Move at least 10 feet (3 meters) away from the fueling point before starting the engine.
3. Stop the engine before refueling the unit. At that time, be sure to sufficiently agitate the mixed gasoline in the container.

■ FOR YOUR ENGINE LIFE, AVOID:

1. **FUEL WITH NO OIL (RAW GASOLINE)** – It will cause severe damage to the internal engine parts very quickly.
2. **GASOHOL** – It can cause deterioration of rubber and/or plastic parts and disruption of engine lubrication.
3. **OIL FOR 4-CYCLE ENGINE USE** – It can cause spark plug fouling, exhaust port blocking, or piston ring sticking.
4. **Mixed fuels which have been left unused for a period of one month or more** may clog the carburetor and result in the engine failing to operate properly.
5. In the case of storing the product for a long period of time, clean the fuel tank after rendering it empty. Next, activate the engine and empty the carburetor of the composite fuel.
6. In the case of scrapping the used mixed oil container, scrap it only at an authorized repository site.

📖 NOTE

- As for details of quality assurance, read the description in the section Limited Warranty carefully. Moreover, normal wear and change in product with no functional influence are not covered by the warranty. Also, be careful that, if the usage in the instruction manual is not observed as to the mixed gasoline, etc. described therein, it may not be covered by the warranty.

8. Operation

STARTING ENGINE

⚠ WARNING

- The cutting head will start rotating upon the engine starts.

1. Feed fuel into the fuel tank and tighten the cap securely.
2. Rest the unit on a flat, firm place. Keep the cutting head off the ground and clear of surrounding objects, as it will start rotating upon starting of the engine.
3. Push the primer pump several times until overflow fuel flows out in the clear tube.

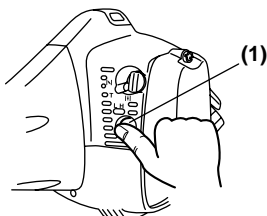

4. Move the choke lever to the closed position.

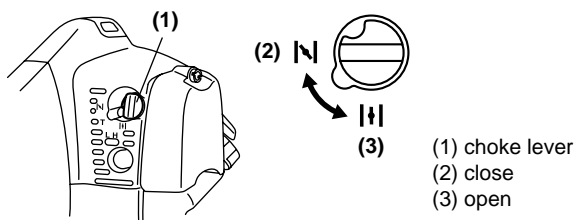

5. Set the ignition switch to the "RUN" position. Place the unit on a flat, firm place. Keep the cutting head clear of everything around it.

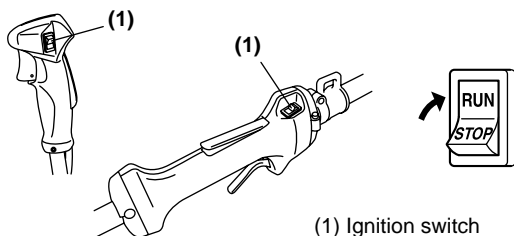

6. While holding the unit firmly, pull out the starter rope quickly until engine fires.

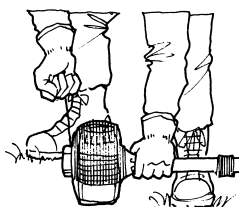

⚠ WARNING

- The product is equipped with a centrifugal clutch mechanism, so the cutting attachment begins to

rotate as soon as the engine is started by putting the throttle into the start position. When starting the engine, place the product onto the ground in a flat clear area and hold it firmly in place so as to ensure that neither the cutting part nor the throttle come into contact with any obstacle when the engine starts.

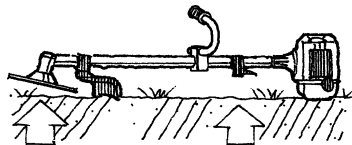

ⓘ IMPORTANT

- Avoid pulling the rope to its end or returning it by releasing the knob. Such actions can cause starter failures.
7. Pull out the throttle to return the choke to the open position.

📖 NOTE

- These model's choke returns to the open position automatically when the throttle is pulled out.
8. Allow the engine to warm up for a several minutes before starting operation.

📖 NOTE

1. When restarting the engine immediately after stopping it, leave the choke open.
2. Overchoking can make the engine hard to start due to excess fuel. When the engine failed to start after several attempts, open the choke and repeat pulling the rope, or remove the spark plug and dry it.

STOPPING ENGINE

1. Release the throttle lever and run the engine for half a minute.
2. Shift the ignition switch to the STOP position.

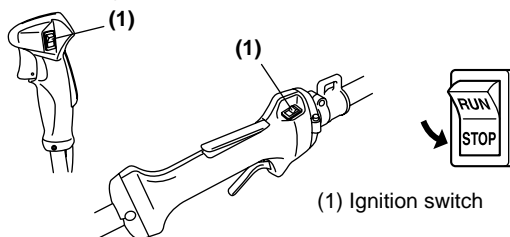

ⓘ IMPORTANT

- Except for an emergency, avoid stopping the engine while pulling the throttle lever.

8. Operation

ADJUSTING THROTTLE CABLE

- The normal play is 1 or 2 mm when measured at the carburetor side end. Readjust with the cable adjuster as required.

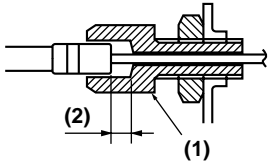

(1) Cable adjuster
(2) 0.04in (1-2mm)

ADJUSTING IDLING SPEED

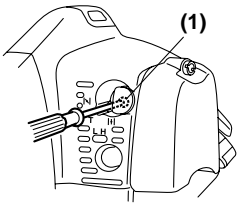

(1) Idle adjusting screw
(cross screw)

- When the engine tends to stop frequently at idling mode, turn the adjusting screw clockwise.
- When the cutting head keeps rotating after releasing the trigger, turn the adjusting screw counter-clockwise.

NOTE

- Warm up the engine before adjusting the idling speed.

CUTTER APPLICATION CHART

- Replace by a suitable recommended cutting attachment according to the object to be cut.
- When replacing blade always be sure to use products which have been certified by KOMATSU ZENOAH.

WARNING

- When sharpening, removing, or reattaching the blade, be sure to wear thick, sturdy gloves and use only proper tools and equipment to prevent injury.

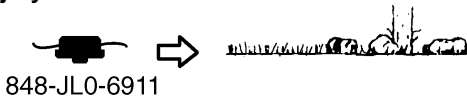

METAL BLADE USAGE

- Check the bolt to fasten the blade and be sure the bolt has no fault, and no abrasion.
- Be sure that the blade and the holder have been fastened according to instruction and the blade turns smoothly without abnormal noise.



WARNING

- The rotating parts fastened incorrectly may cause serious accident to the operator.
- Make sure that the blade is not bent, warped, cracked, broken or damaged.
- If you find any error to the blade, discard it and change new one which is certified by KOMATSU ZENOAH.
- By using the shoulder strap, hang the unit on your right side. Adjust the strap length so that the cutting head may become parallel to the ground.

WARNING

- Make sure to use shoulder strap and debris guard. If not, it is very dangerous when you slip or lose your balance.



- Be sure to use genuine parts made of Zenoah for blades. In particular, never use special blades such as shredder blades. If you use a special blade, the unit may fail.

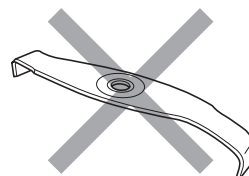

8. Operation

CUTTING METHOD

- Use the front left side cutting.
- Guide the blade from your right to left with it tilted slightly to your left.
- When mowing a wide area, start working from your left end to avoid interference of cut grass.
- The blade may be seized by weeds if the engine speed is too low, or the blade cuts too deep into weeds. Adjust the engine speed and cutting depth according to the condition of object.

▲ WARNING

- If the grass or other object gets caught in the blade, or if the unit starts to shake or vibrate, turn off the engine and check the whole unit. Change the blade if it has been damaged.
- Turn off the engine and make sure the blade has completely stop before checking the blade, and removing any object got caught in.

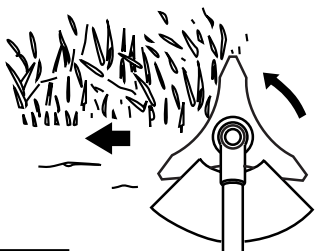

▲ WARNING

CONTROLLING BLADE BOUNCE

- Blade thrust can cause serious personal injury. Carefully study this section. It is important that you understand what causes blade thrust, how you can reduce the chance of blade thrust and how you can remain in control of the unit if blade thrust does occur.

1. What causes blade thrust:

- Blade thrust can occur when the moving blade contacts an object that it cannot cut. This contact causes the blade to stop for an instant and then suddenly move or "bounce" away from the object that was hit. The operator can lose control of the unit and the blade can cause serious personal injury to the operator or any person nearby if the blade contacts any part of the body.

2. How you can reduce the chance of blade thrust:

- Recognize that blade thrust can happen. By understanding and knowing about bounce, you can help eliminate the element of surprise.
- Cut fibrous weeds and grass only. Do not let the blade contact materials it cannot cut such as hard, woody vines and brush or rocks, fences, metal, etc
- Be extra prepared for bounce if you must cut where you cannot see the blade making contact such as in areas of dense growth.

- Keep the blade sharp. A dull blade increase the chance of bounce.
- Avoid feeding the blade too rapidly. The blade can bounce away from material being cut if the blade is fed faster than its cutting capability.
- Cut only from your right to your left.
- Keep your path of advance clear of material that has been cut and other debris.

3. How you can maintain the best control:

- Keep a good, firm grip on the unit with both hands. A firm grip can help neutralize bounce. Keep your right and left hands completely around the respective handles.
- Keep both feet spread apart in a comfortable stance and yet braced for the possibility that the unit could bounce. Do not overreach. Keep firm footing and balance.

CUTTING WORK (LINE HEAD USAGE)

▲ WARNING

- Always wear eye protection such as safety goggles. Never lean over the rotating cutting head. Rocks or other debris could be thrown into eyes and face and cause serious personal injury.
- Keep the debris guard in place at all times when the unit is operated.

TRIMMING GRASS AND WEEDS

- Always remember that the TIP of the line does cutting. You will achieve better results by not crowding the line into the cutting area. Allow the unit to trim at its own pace.
- Hold the unit so the head is off the ground and is tilted about 20 degrees toward the sweep direction.

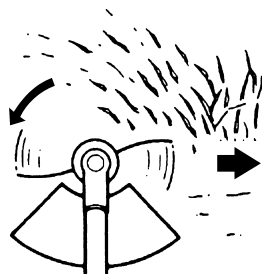

- You can avoid thrown debris by sweeping from your left to the right.
- Use a slow, deliberate action to cut heavy growth. The rate of cutting motion will depend on the material being cut. Heavy growth will require slower action than will light growth.
- Never swing the unit so hard as you are in danger of losing your balance or control of the unit.
- Try to control the cutting motion with the hip rather

8. Operation

than placing the full workload on the arm and hands.

- Take precautions to avoid wire, grass and dead, dry, long-stem weeds from wrapping around the head shaft. Such materials can stall the head and cause the clutch to slip, resulting in damage to the clutch system if repeated frequently.

ADJUSTING THE LINE LENGTH

- Your brush cutter is equipped with a semi- auto type nylon line head that allows the operator to advance the line without stopping the engine. When the line becomes short, lightly tap the head on the ground while running the engine at full throttle.
- Each time the head is bumped, the line advances about 25 mm. For better effect, tap the head on bear ground or hard soil. Avoid bumping in thick, tall grass as the engine may stall by overload.
- Make the right and left lines the same length when using the nylon line head.
(Be sure to install the genuine Zenoah debris guard when using the nylon line head.)
- If the lengths of the right and left lines are different, the balance of the nylon line head will be disrupted, resulting in increased vibration and product damage.

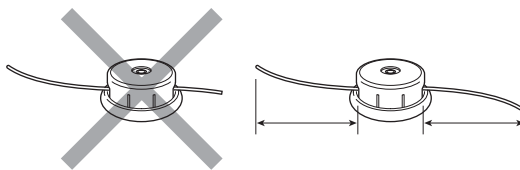

- If you feel a vibration increase or drive shaft housing shaking while using the nylon line head, immediately stop operation, check the following items, and correct any problems.

The lengths of the right and left lines are significantly different.

-->Make them the same length.

The cover is removed.

-->Make sure to install it securely.

There is a crack or damage outside.

-->Replace the damaged part.

- If vibration or shaking persists even after repairing, or if you cannot identify the cause of abnormality, contact your local authorized Komatsu Zenoah dealer for repair.
- Never continue to operate the unit when vibration or shaking of the drive shaft housing persists.

9. Maintenance

	System/components	Procedure	Before use	Every 25 hours after	Every 50 hours after	Every 100 hours after	Note
ENGINE	fuel leaks, fuel spillage	wipe out	✓				
	fuel tank, air filter, fuel filter	inspect/clean	✓	✓			replace, if necessary
	idle adjusting screw	see adjusting idling speed	✓				replace carburetor if necessary
	spark plug	clean and readjust plug gap			✓		GAP: .025 in (0.6 ~ 0.7 mm) replace, if necessary
	cylinder fins, intake air cooling vent muffler, spark arrester, cylinder exhaust port	clean		✓		✓	
SHAFT	throttle lever, ignition switch	check operation	✓				
	cutting parts	replace if something's wrong	✓				
	gear case	grease		✓			
	screws/nuts/bolts	tighten/replace	✓			✓	not adjusting screws
	debris guard	make sure to attach	✓				

9. Maintenance

REFILLING TRIMMING LINE

- For replacement line, use a diameter of 2.4mm (.095in). The spool is capable for a line upto 6m(20ft) on the 10cm(4") head. Avoid using a larger line as it may cut down the trimming performance.

⚠ WARNING

- For safety reasons, do not use metalreinforced line.
- Pinch the slotted area on the both sides of the spool housing to unhook the bottom cap.
 - Take out the spool and pull off the old line. Put one end of new line through the spool holes and pull it until the length is equal between each part of the line.
 - Wind up the line in the correct direction as indicated on the spool.
 - Hook each end of the line in the slot on the edge of the spool, and then put the ends through the eyelets on the housing. Make sure that the spring and the washers are in place.
 - While holding the spool against the housing, pull the line ends to release them from the slot.
 - Line up the slot on the bottom cap with the hook on the housing, press the cap against the housing until it clicks.

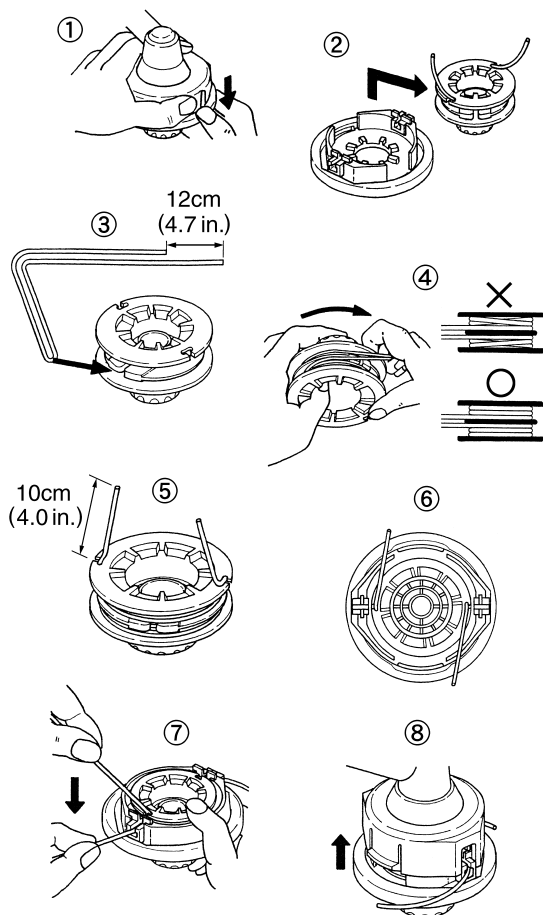

BLADE

- Check the blade and the fasteners for looseness, cracking, or bending.
- Check the cutting edges and reform with a flat file.

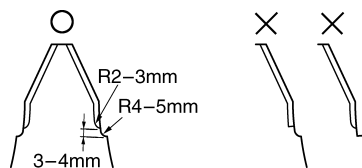

Point :

- Keep the end corner sharp.
 - Round the root of the edge, using round file.
 - Do not use water when using a grinder.
- It is recommended that filing should be done by professionals.
 - Especially regarding filing the saw blade, Leave it to the professionals.

⚠ WARNING

- Make sure that the engine has stopped and is cool before performing any service to the machine. Contact with moving cutting head or hot muffler may result in a personal injury.

AIR FILTER

- The air filter, if clogged, will reduce the engine performance. Check and clean the paper element by air blow as required. If the element becomes dirty, replace with a new one.

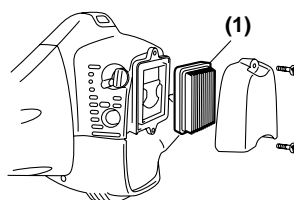

(1) Paper element

FUEL FILTER

- When the engine runs short of fuel supply, check the fuel cap and the fuel filter for blockage.

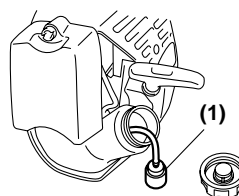

(1) Fuel filter

SPARK PLUG

- Starting failure and misfiring are often caused by a fouled spark plug. Clean the spark plug and check that the plug gap is in the correct range. For a replacement plug, use the correct type specified by KOMATSU ZENOAH.

9. Maintenance

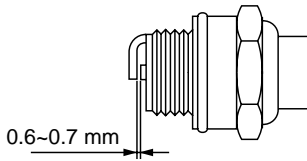

- **REPLACEMENT PLUG IS A NGK CMR7H.**

ⓘ IMPORTANT

- Note that using any spark plug other than those designated may result in the engine failing to operate properly or in the engine becoming overheated and damaged.
- To install the spark plug, first turn the plug until it is finger tight, then tighten it a quarter turn more with a socket wrench.

TIGHTENING TORQUE: 87 ~ 104 in-lbs
(9.8 ~ 11.8 N.m.)

MUFFLER

⚠ WARNING

- **Inspect periodically, the muffler for loose fasteners, any damage or corrosion. If any sign of exhaust leakage is found, stop using the machine and have it repaired immediately.**
- **Note that failing to do so may result in the engine catching on fire.**

GEAR CASE

- The reduction gears are lubricated by multipurpose, lithium-based grease in the gear case. Supply new grease every 25 hours of use or more often depending on the job condition.
- Remove the bolt of the grease nipple and the bolt opposite side of the grease nipple. Install new grease into the grease nipple to arrange for old grease to exit from the opposite side.

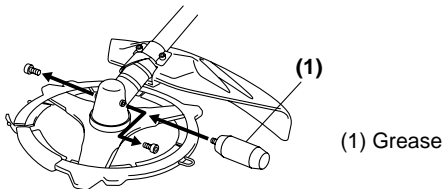

INTAKE AIR COOLING VENT

⚠ WARNING

- **Never touch the cylinder, muffler, or spark plugs with your bare hands immediately after stopping the engine. The engine can become very hot when in operation, and doing so could result in severe burns.**

- **When checking the machine to make sure that it is okay before using it, check the area around the muffler and remove any wood chips or leaves which have attached themselves to the brushcutter. Failing to do so could cause the muffler to become overheated and that in turn could cause the engine to catch on fire. Always make sure that the muffler is clean and free of wood chips, leaves, and other waste before use.**
- **Check the intake air cooling vent and the area around the cylinder cooling fins after every 25 hours of use for blockage, and remove any waste which has attached itself to the brushcutter. Note that it is necessary to remove the upper cover and the lower cover shown in in order to be able to view the upper part of the cylinder.**

ⓘ IMPORTANT

- If waste gets stuck and causes blockage around the intake air cooling vent or between the cylinder fins, it may cause the engine to overheat, and that in turn may cause mechanical failure on the part of the brushcutter.

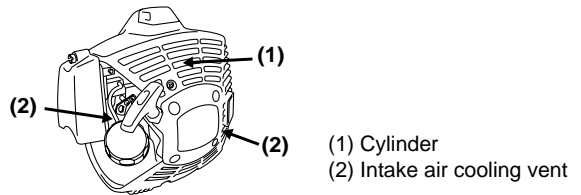

PROCEDURES TO BE PERFORMED AFTER EVERY 100 HOURS OF USE

1. Remove the muffler, insert a screwdriver into the vent, and wipe away any carbon buildup. Wipe away any carbon buildup on the muffler exhaust vent and cylinder exhaust port at the same time.
2. Tighten all screws, bolts, and fittings.
3. Check to see if any oil or grease has worked its way in between the clutch lining and drum, and if it has, wipe it away using oil-free, lead-free gasoline.



10. Storage

Aged fuel is one of major causes of engine starting failure. Before storing the unit, empty the fuel tank and run the engine until it uses all the fuel left in the fuel line and the carburetor. Store the unit indoor taking necessary measures for rust prevention.

11. Troubleshooting guide

Case 1. Starting failure

CHECK	PROBABLE CAUSES	ACTION
fuel tank	→ incorrect fuel	→ drain it and use correct fuel
fuel filter	→ fuel filter is clogged	→ clean
carburetor adjustment screw	→ out of normal range	→ adjust to normal range
sparkling (no spark)	→ spark plug is fouled/wet	→ clean/dry
	→ plug gap is incorrect	→ correct (GAP: 0.6 ~ 0.7 mm)
spark plug	→ disconnected	→ retighten

Case 2. Engine starts but does not keep running/hard re-starting

CHECK	PROBABLE CAUSES	ACTION
fuel tank	→ incorrect fuel or staled fuel	→ drain it and use correct fuel
carburetor adjustment screw	→ out of normal range	→ adjust to normal range
muffler, cylinder (exhaust port)	→ carbon is built-up	→ wipe away
air cleaner	→ clogged with dust	→ wash
cylinder fin, fan cover	→ clogged with dust	→ clean

When your unit seems to need further service, please consult with our KOMATSU ZENOAH® service shop in your area.

Limited warranty

Should any failure occur on the product under normal operating conditions within the applicable warranty period, the failed part will be replaced or repaired free of charge by a KOMATSU ZENOAH® authorized dealer.

WARRANTY PERIOD: 1 year (6 months if used professionally, and 30 days if used for rental purpose) from the date of initial purchase.

THE PURCHASER SHALL BEAR COSTS OF TRANSPORTING THE UNIT TO AND FROM THE KOMATSU ZENOAH DEALER.

THE PURCHASER SHALL NOT BE CHARGED FOR DIAGNOSTIC LABOR WHICH LEADS TO THE DETERMINATION THAT A WARRANTED PART IS DEFECTIVE, IF THE DIAGNOSTIC WORK IS PERFORMED AT THE KOMATSU ZENOAH DEALER.

THE PURCHASER OR OWNER IS RESPONSIBLE FOR THE PERFORMANCE OF THE REQUIRED MAINTENANCE AS DEFINED BY THE MANUFACTURER IN THE OWNER/OPERATOR MANUAL.

ANY WARRANTED PART WHICH IS NOT SCHEDULED FOR REPLACEMENT AS REQUIRED MAINTENANCE, OR WHICH IS SCHEDULED ONLY FOR REGULAR INSPECTION TO THE EFFECT OF REPAIR OR "REPLACE AS NECESSARY" SHALL BE WARRANTED FOR THE WARRANTY PERIOD. ANY WARRANTED PART WHICH IS SCHEDULED FOR REPLACEMENT AS REQUIRED MAINTENANCE SHALL BE WARRANTED FOR THE PERIOD OF TIME UP TO THE FIRST SCHEDULED REPLACEMENT POINT FOR THE PART.

ANY REPLACEMENT PART THAT IS EQUIVALENT IN PERFORMANCE AND DURABILITY MAY BE USED IN NON-

WARRANTY MAINTENANCE OR REPAIRS, AND SHALL NOT REDUCE THE WARRANTY OBLIGATION OF THE COMPANY.

THE COMPANY IS LIABLE FOR DAMAGES TO OTHER ENGINE COMPONENTS CAUSED BY THE FAILURE OF A WARRANTED PARTS STILL UNDER WARRANTY.

THE WARRANTY DOES NOT APPLY TO THOSE UNITS WHICH HAVE BEEN DAMAGED BY NEGLIGENCE OF INSTRUCTION LISTED IN THE OWNER/OPERATOR MANUAL FOR PROPER USE AND MAINTENANCE OF THE UNITS ACCIDENT MISHANDLING, ALTERATION, ABUSE, IMPROPER LUBRICATION, USE OF ANY PARTS OR ACCESSORIES OTHER THAN THOSE SPECIFIED BY THE COMPANY, OR OTHER CAUSES BEYOND THE COMPANY'S CONTROL.

THIS WARRANTY DOES NOT COVER THOSE PARTS REPLACED BY NORMAL WEAR OR HARMLESS CHANGES IN THEIR APPEARANCE.

THERE ARE NO OTHER EXPRESS WARRANTIES.

IMPLIED WARRANTIES INCLUDING THOSE OF MERCHANTABILITY AND FITNESS FOR A PARTICULAR PURPOSE **ARE LIMITED** TO TWO (2) YEARS OF HOME USE [ONE (1) YEAR FOR ANY OTHER USE] FROM THE ORIGINAL DELIVERY DATE.

LIABILITIES FOR INCIDENTAL OR CONSEQUENTIAL DAMAGE UNDER ANY AND ALL WARRANTIES ARE EXCLUDED.

IF YOU NEED TO OBTAIN MORE INFORMATION, PLEASE CALL YOUR NEAREST SERVICE CENTER, OR CHECK PLEASE KOMATSU ZENOAH WEB SITE <http://www.zenoah.net>



KOMATSU ZENOH CO.

1-9 Minamidai, Kawagoe-city, Saitama, 350-1192 Japan

Free Manuals Download Website

<http://myh66.com>

<http://usermanuals.us>

<http://www.somanuals.com>

<http://www.4manuals.cc>

<http://www.manual-lib.com>

<http://www.404manual.com>

<http://www.luxmanual.com>

<http://aubethermostatmanual.com>

Golf course search by state

<http://golfingnear.com>

Email search by domain

<http://emailbydomain.com>

Auto manuals search

<http://auto.somanuals.com>

TV manuals search

<http://tv.somanuals.com>