

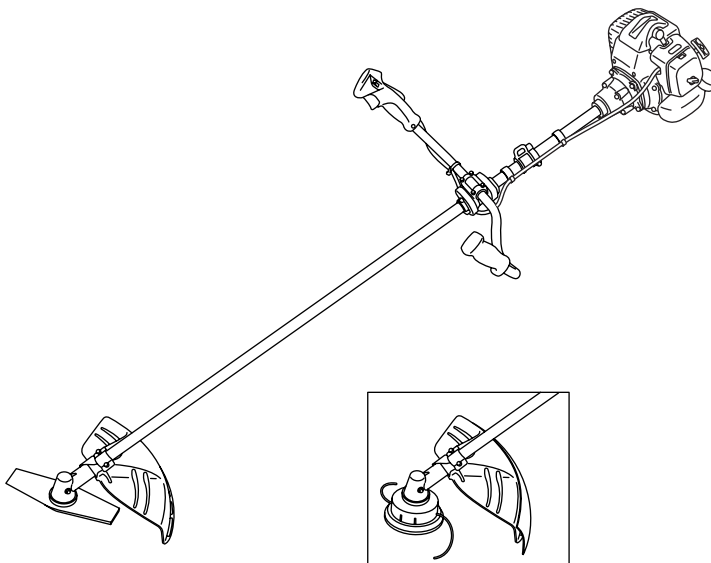

OWNER'S MANUAL

BRUSHCUTTERS

KAM-402



Caution

- Before using our brushcutter, please read this manual carefully to understand the proper use of your unit.
- Keep this manual handy.

SAFETY FIRST

Instructions contained in warnings within this manual marked with a  symbol concern critical points which must be taken into consideration to prevent possible serious bodily injury, and for this reason you are requested to read all such instructions carefully and follow them without fail.

■ NOTES ON TYPES OF WARNINGS IN THE MANUAL

WARNING

This mark indicates instructions which must be followed in order to prevent accidents which could lead to serious bodily injury or death.

IMPORTANT

This mark indicates instructions which must be followed, or it leads to mechanical failure, breakdown, or damage.

NOTE

This mark indicates hints or directions useful in the use of the product.

Contents

1. Warning labels on the machine	3
2. Symbols on the machine	4
3. Specifications	4
4. Safety precautions	5
5. Set up	9
6. Fuel	11
7. Operation	12
8. Maintenance	15
9. Trouble shooting	17
10. Disposal	17

1. Warning labels on the machine



- (1) Read owner's manual before operating this machine.
- (2) Wear head, eye and ear protection.
- (3) Wear foot protection.
- (4) Wear gloves.
- (5) Beware of thrown objects.
- (6) Warning / Attention
- (7) Keep all children, bystanders and helpers 15 meters away from the machine.

❗ IMPORTANT

If warning label peels off or becomes soiled and impossible to read, you should contact the dealer from which you purchased the product to order new labels and affix them in the required location(s).

⚠ WARNING

Never modify your machine.

We won't warrant the machine, if you use the remodeled brushcutter or if you don't observe the proper usage written in the manual.

2. Symbols on the machine

For safe operation and maintenance, symbols are carved in relief on the machine. According to these indications, please be careful not to take a mistake.



(a)

(a) The port to refuel the "MIX GASOLINE"

Position: FUEL TANK CAP



(b)

(b) The direction to close the choke

Position: AIR CLEANER COVER



(c)

(c) The direction to open the choke

Position: AIR CLEANER COVER

3. Specifications

Name/Type		ZENOAH Brushcutter
Handle Type		KAM-402
Machine Weight (*1) kg		Double
Outward Size (L x W x H) mm		7.8
Outer pipe mm		1845 x 650 x 560
Applied Head		1500 / ø28
Power Transmission Method		2-teeth blade(12"), 4-teeth blade, 8-teeth blade, round saw blade(10"), line head
Reduction Rate		Automatic centrifugal clutch, spiral gear
Blade Rotating Direction		1.400 (21 : 15)
Type		Counterclockwise (from operator' s view)
Engine	Type	Single cylinder air cooling 2-cycle gasoline engine
	Displacement Volume cc	41.5
	Fuel Tank Capacity ℓ	0.94
	Fuel Used	Lubricating oil mixed gasoline
	Lubricating Oil Used	2-cycle engine oil
	Mixing rate	when using ZENOAH genuine oil (FC grade): 50:1 when using market oil (FB grade): 25:1
	Carburetor	float, piston valve
	Sparking Method	C D I
	Spark Plug	NGK BPMR7A
	Starting Method	Recoil starter
	Stopping Method	Sparking Circuit Primary Short (push button)

(*1) excluding cutting head, shoulder strap and fuel

Please note that due to improvement, detailed specifications of the product may differ from the information herein.

▲ 4. Safety precautions



1. Read this manual carefully until you completely understand and follow all safety and operating instructions.
2. Keep this manual handy so that you may refer to it later whenever any questions arise. Also note, if you have any questions which cannot be answered herein, contact the dealer from whom you purchased the product.
3. Always be sure to include this manual when selling, lending, or otherwise transferring the ownership of this product.
4. Never allow children or anyone unable to fully understand the directions given in the manual to use the machine.



■ WORKING CONDITION

1. When using the product, you should wear proper clothing and protective equipment.



- (1) **Helmet**
- (2) **Ear protectors**
- (3) **Protection goggles or face protector**
- (4) **Thick work gloves**
- (5) **Non-slip-sole work boots**

2. And you should carry with you.

- (1) Attached tools
- (2) Properly reserved fuel
- (3) Spare blade
- (4) Things to notify your working area (rope, warning signs)
- (5) Whistle (for collaboration or emergency)
- (6) Hatchet or saw (for removal of obstacles)



3. Do not wear loose clothing, jewelry, short trousers, sandals, or go barefoot. Do not wear anything which might be caught by a moving part of the unit. Secure hair so it is above shoulder length.

■ WORKING CIRCUMSTANCE

1. Never start the engine inside a closed room or building. Exhaust gases contain dangerous carbon monoxide.



2. Never use the product,
 - (1) When the ground is slippery or when you can't maintain a steady posture.
 - (2) At night, at times of heavy fog, or at any other times when your field of vision might be limited and it would be difficult to gain a clear view of the working area.
 - (3) During rain storms, during lightning storms, at times of strong or gale-force winds, or at any other times when weather conditions might make it unsafe to use the product.



■ WORKING PLAN

1. You should never use the product when under the influence of alcohol, when suffering from exhaustion or lack of sleep, when suffering from drowsiness as a result of having taken cold medicine or at any other time when a possibility exists that your judgment might be impaired or that you might not be able to operate the product properly and in a safe manner.
2. When planning your work schedule, allow plenty of time to rest. Limit the amount of time over which the product is to be used continuously to somewhere around 30 ~ 40 minutes per session, and take 10 ~ 20 minutes of rest between work sessions. Also try to keep the total amount of work performed in a single day under 2 hours or less.



▲ WARNING

1. If you don't observe the working time, or working manner (**See "USING THE PRODUCT"**), Repetitive Stress Injury (RSI) could occur. If you feel discomfort, redness and swelling of your fingers or any other part of your body, see a doctor before getting worse.
2. To avoid noise complaints, in general, operate product between 8 a.m. and 5 p.m. on weekdays and 9 a.m. to 5 p.m. on weekends.



📖 NOTE

Check and follow the local regulations as

▲ 4. Safety precautions

to sound level and hours of operations for the product.

■ BEFORE STARTING THE ENGINE

1. The area within a perimeter of 15 m of the person using the product should be considered a hazardous area into which no one should enter. If necessary, yellow warning rope, warning signs should be placed around the perimeter of the area. When work is to be performed simultaneously by two or more persons, care should also be taken to constantly look around or otherwise check for the presence and locations of other people working so as to maintain a distance between each person sufficient to ensure safety.
2. Check the condition of working area to avoid any accident by hitting hidden obstacles such as stumps, stones, cans, or broken glass.



❗ IMPORTANT

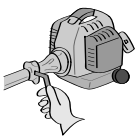

Remove any obstacle before beginning work.

3. Inspect the entire unit for loose fasteners and fuel leakage. Make sure that the cutting attachment is properly installed and securely fastened.
4. Be sure the cutting attachment guard is firmly attached in place.
5. Always use the harness. Adjust the harness for comfort before starting the engine. The harness should be adjusted so the left hand can comfortably hold the handlebar grip approximately waist high.



■ STARTING THE ENGINE

1. Keep bystanders and animals at least 15 m away from the operating point. If you are approached, immediately stop the engine.
2. The product is equipped with a centrifugal clutch mechanism, so the cutting attachment begins to rotate as soon as the engine is started by putting the throttle trigger into the start position. When starting the engine, place the product onto the ground in a flat clear area and hold it firmly in place

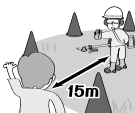

so as to ensure that neither the cutting part nor the throttle trigger come into contact with any obstacle when the engine starts.

▲ WARNING

Never place the throttle trigger into the high-speed position when starting the engine.

3. After starting the engine, check to make sure that the cutting attachment stops rotating when the throttle is moved fully back to its original position. If it continues to rotate even after the throttle trigger has been moved fully back, turn off the engine and take the unit to your authorized ZENOAH servicing dealer for repair.

■ USING THE PRODUCT

❗ IMPORTANT



Cut only materials recommended by the manufacturer. And use only for tasks explained in the manual.

1. Grip the handles firmly with both hands using your whole hand. Place your feet slightly apart (slightly further apart than the width of your shoulders) so that your weight is distributed evenly across both legs, and always be sure to maintain a steady, even posture while working.
2. Keep cutting attachment below waist level.
3. Maintain the speed of the engine at the level required to perform cutting work, and never raise the speed of the engine above the level necessary.
4. If the unit starts to shake or vibrate, turn off the engine and check the whole unit. Do not use it until the trouble has been properly corrected.
5. Keep all parts of your body away from rotating cutting attachment and hot surfaces.
6. Never touch the muffler, spark plug, or other metallic parts of the engine while the engine is in operation or immediately after shutting down the engine. Doing so could result in



▲ 4. Safety precautions

serious burns or electrical shock.

■ IF SOMEONE COMES

1. Guard against hazardous situations at all times. Warn adults to keep pets and children away from the area. Be careful if you are approached. Injury may result from flying debris.
2. If someone calls out or otherwise interrupts you while working, always be sure to turn off the engine before turning around.



■ MAINTENANCE

1. In order to maintain your product in proper working order, perform the maintenance and checking operations described in the manual at regular intervals.
2. Always be sure to turn off the engine and disconnect the spark plug wire before performing any maintenance or checking procedures.

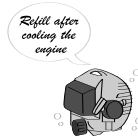

▲ WARNING

The metallic parts reach high temperatures immediately after stopping the engine.

3. When replacing the cutting attachment or any other part, or when replacing the oil or any lubricant, always be sure to **use only ZENOAH products or products which have been certified by ZENOAH for use with the ZENOAH product.**
4. In the event that any part must be replaced or any maintenance or repair work not described in this manual must be performed, please contact a representative from the store nearest ZENOAH authorized servicing dealer for assistance.
5. Do not use any accessory or attachment other than those bearing the ZENOAH mark and recommended for the unit.
6. Under no circumstances should you ever take apart the product or alter it in any way. Doing so might result in the product becoming damaged during operation or the product becoming unable to operate properly.

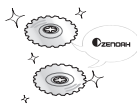

■ HANDLING FUEL

1. The engine of the ZENOAH product is designed to run on a mixed fuel, which contains highly flammable gasoline. Never store cans of fuel or refill the tank of the unit in any place where there is a boiler, stove, wood fire, electrical sparks, welding sparks, or any other source of heat or fire which might ignite the fuel.
2. Never smoke while operating the unit or refilling its fuel tank.
3. When refilling the tank, always turn off the engine and allow it to cool down. Take a careful look around to make sure that there are no sparks or open flames anywhere nearby before refueling.
4. Wipe spilled fuel completely using a dry rag if any fuel spillage occurs during refueling.
5. After refueling, screw the fuel cap back tightly onto the fuel tank and then carry the unit to a spot 3 m or more away from where it was refueled before turning on the engine.

■ TRANSPORTATION

1. When hand-carrying the product, cover over the cutting part if necessary, lift up the product and carry it paying attention to the blade.
2. Never transport the product over rough roads over long distances by vehicle without removing all fuel from the fuel tank. If doing so, fuel might leak from the tank during transport.

▲ WARNING

■ CONTROLLING BLADE THRUST

Blade thrust can cause serious personal injury. Carefully study this section. It is important that you understand what causes blade thrust, how you can reduce the chance of blade thrust and how you can remain in control of the unit if blade thrust does occur.

1. What causes blade thrust:

Blade thrust can occur when the moving blade contacts an object that it cannot cut.

▲ 4. Safety precautions

This contact causes the blade to stop for an instant and then suddenly move or "bounce" away from the object that was hit. The operator can lose control of the unit and the blade can cause serious personal injury to the operator or any person nearby if the blade contacts any part of the body.

2. How you can reduce the chance of blade thrust:

- (1) Recognize that blade thrust can happen. By understanding and knowing about bounce, you can help eliminate the element of surprise.
- (2) Cut fibrous weeds and grass only. Do not let the blade contact materials it cannot cut such as hard, woody vines and brush or rocks, fences, metal, etc
- (3) Be extra prepared for blade thrust if you must cut where you cannot see the blade making contact such as in areas of dense growth.
- (4) Keep the blade sharp. A dull blade increase the chance of blade thrust.
- (5) Avoid feeding the blade too rapidly. The blade can bounce away from material being cut if the blade is fed faster than its cutting capability.
- (6) Cut only from your right to your left.
- (7) Keep your path of advance clear of material that has been cut and other debris.

3. How you can maintain the best control:

- (1) Keep a good, firm grip on the unit with both hands. A firm grip can help neutralize bounce. Keep your right and left hands completely around the respective handles.
- (2) Keep both feet spread apart in a comfortable stance and yet braced for the possibility that the unit could bounce. Do not overreach. Keep firm footing and balance.

5. Set up

▲ WARNING

- Assemble each part correctly. Wrong assembly might cause an accident.
- If you cannot do the assembling yourself, consult the shop where you bought this product.

■ ENGINE

- Using attached 4 socket screws, secure the connection firmly with equal force.

SE1

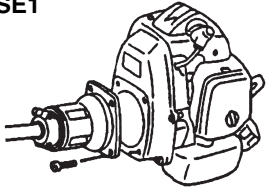

■ HANDLE

1. Loosen the 4 bolts on the upper cap and insert the handles equally. Retighten the bolts.
2. Put the handle assembly into the bracket and put the upper cap over it. Tighten the cap securely.

SE2

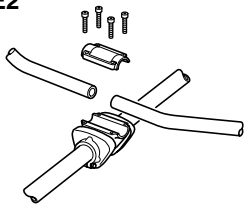

■ CONNECTING THROTTLE WIRE

1. Remove the air cleaner cover.
2. Connect the end of the throttle wire to the joint on the top of the carburetor.

SE3

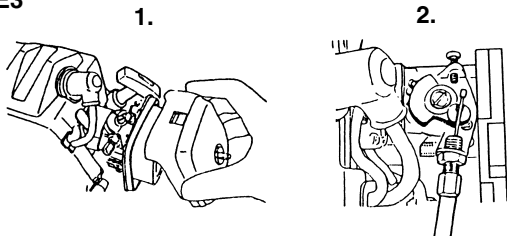

■ CONNECTING SWITCH WIRES

- Connect the switch wires between the engine and the main unit.

SE4

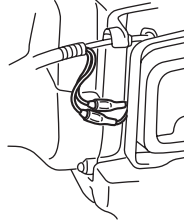

■ INSTALLING DEBRIS GUARD

1. Fit the guard skirt on debris guard.
2. Attach the debris guard with the bolts provided to the pipe.

SE5

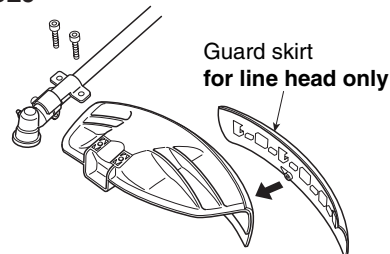

■ INSTALLING LINE HEAD

1. While locking the gear shaft by inserting the hexagonal bar into the holder A on the gear box, loosen and remove the nut (left-handed) and holder B.
2. Fit the line head assembly to the gear shaft. Tighten it securely by hand.

SE6

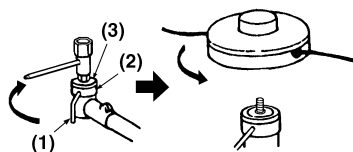

- (1) Hexagonal bar
- (2) Holder A
- (3) Holder B

5. Set up

■ INSTALLING BLADE

Remove the guard skirt of debris guard, when using metal blade.

1. Put the hexagonal bar into the side holes of the holder A and the gearcase.
2. Remove the nut(Left-handed) and the holder B from the gearshaft.
3. Put the blade onto the holder A. Make the marked side face the holder.
4. Put the holder B onto the gearshaft making the recessed side face the blade.
5. Fasten the blade by the nut and the cover.

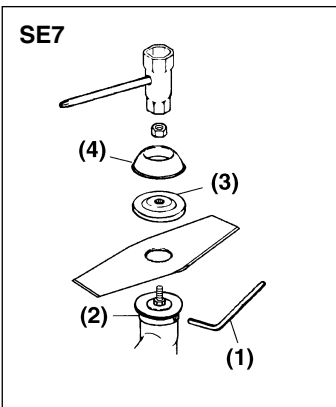

- (1) Hexagonal bar
(2) Holder A
(3) Holder B
(4) Cover

■ BLADE

▲ WARNING

- Do not install or remove the blade while the engine is in operation.
- Use ZENOAH's genuine replacement blades and metal fixtures when installing the blade.
- When installing or removing the blade, fix the machine securely, and wear robust gloves.
- The blade turns counterclockwise (viewed from the gear case). When using an inside-out blade, check the direction of the blade before installing it. In particular, if you install a chip saw in the wrong direction, the chips might break and scatter.

ⓘ IMPORTANT

Look at the blade from above, and make sure that the direction in which the blade is mounted is correct. (SE8)

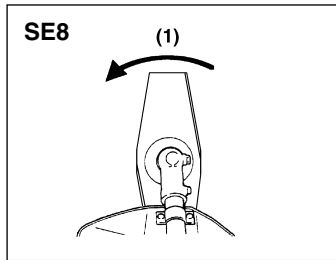

(1) Rotating direction

■ BALANCE UNIT

1. Put on strap and attach unit to strap.
2. Slide clamp up or down until unit balances with head aparting from the ground when using it.



6. Fuel



▲ WARNING

- Gasoline is very flammable. Avoid smoking or bringing any flame or sparks near fuel.
- Wipe up all spills before starting the engine.
- Make sure to stop the engine and allow it cool before refueling the unit.
- Keep open flames away from the area where fuel is handled or stored.

❗ IMPORTANT

- Never use oil for 4 cycle engine use or water cooled 2-cycle engine.
- Never use "FUEL WITH NO OIL (RAW GASOLINE)".
- Never use fuel laced with water.
- Mixed fuels which have been left unused for a period of one month or more may clog the carburetor or result in the engine failing to operate properly. Put remained fuel into an air-tight container and keep it in the dark and cool room.
- Please ask for "mixed gasoline for air-cooled 2-cycle engines" at your nearest gas station, or use fuel made by putting unleaded gasoline for automobiles and air-cooled 2-cycle engine oil into a mixing container in accordance with the following ratios and then shaking to mix well.

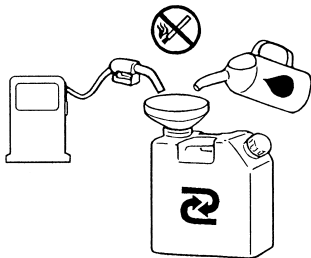

Mixing ratios:

When using Zenoah genuine 2-cycle oil (FC grade):

50:1 (100 ml of oil for every 5 liters of gasoline)

When using commercially available 2-cycle oil (FB grade):

25:1 (160 ml of oil for every 4 liters of gasoline)

7. Operation

■ REFUELING

▲ WARNING

- Refuel the fuel tank in a flat place outdoors. Avoid smoking or bringing any flame or spark near the fuel, and stub out any cigarette.
- When refueling the fuel tank while using this machine, make sure to stop the engine and allow it to cool before refueling the fuel tank.
- Make sure to tighten the fuel-tank cap firmly.
- Wipe up all fuel spills with a dry cloth before starting the engine.

🔧 IMPORTANT

Fill the fuel tank to roughly 80% of its capacity. If filled too full, the fuel may leak from the tank cap while using this machine.

1. Place the brushcutter to be refueled in a flat place outdoors, and make sure it is stable.
2. Unscrew the fuel-tank cap a little, and allow the difference of atmospheric pressure between the inside and outside of the fuel tank to equalize.
3. Remove the fuel-tank cap, and fill fuel little by little up to roughly 80%.
4. After filling the fuel, close the fuel-tank cap tightly, and make sure that the fuel does not leak.

■ STARTING ENGINE

▲ WARNING

The cutting head will start rotating upon the engine starts.

1. Feed fuel into the fuel tank and tighten the cap securely.
2. Rest the unit on a flat, firm place. Keep the cutting head off the ground and clear of surrounding objects, as it will start rotating upon starting of the engine.
3. Push the primer pump several times until overflow fuel flows out in the clear tube.

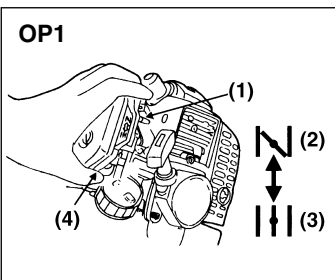

- (1) Choke lever
- (2) Close
- (3) Open
- (4) Primer pump

4. Move the choke lever to the closed position.

5. Set the stop switch to the "RUN" position.

Place the unit on a flat, firm place.

Keep the cutting head clear of everything around it.

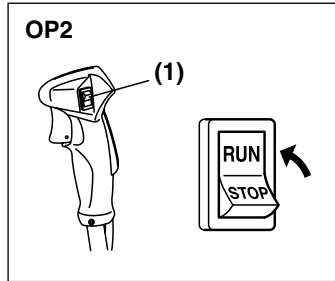

- (1) Stop switch

6. While holding the unit firmly, pull out the starter rope quickly until engine fires.

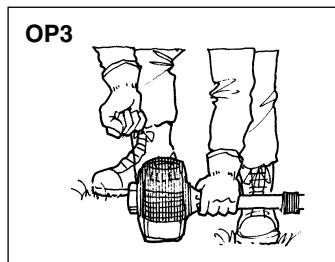

▲ WARNING

The product is equipped with a centrifugal clutch mechanism, so the cutting attachment begins to rotate as soon as the engine is started by putting the throttle into the start position. When starting the engine, place the product onto the ground in a flat clear area and hold it firmly in place so as to ensure that neither the cutting part nor the throttle come into contact with any obstacle when the engine starts.

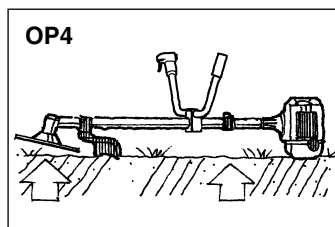

🔧 IMPORTANT

Avoid pulling the rope to its end or returning it by releasing the knob. Such actions can cause starter failures.

7. Move the choke lever downward to open the choke. And restart engine.
8. Allow the engine to warm up for a several minutes before starting operation.

7. Operation

NOTE

1. When restarting the engine immediately after stopping it, leave the choke open.
2. Overchoking can make the engine hard to start due to excess fuel. When the engine failed to start after several attempts, open the choke and repeat pulling the rope, or remove the spark plug and dry it.

■ STOPPING ENGINE

1. Release the throttle trigger and run the engine for half a minute.
2. Shift the stop switch to the STOP position.

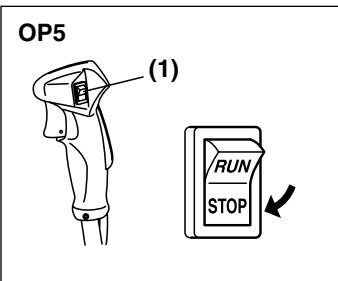

(1) Stop switch

⚠ IMPORTANT

Except for an emergency, avoid stopping the engine while pulling the throttle lever.

■ ADJUSTING THROTTLE CABLE

- The normal play is 1 or 2 mm when measured at the carburetor side end. Readjust with the cable adjuster as required.

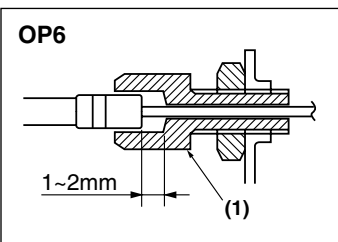

(1) Cable adjuster

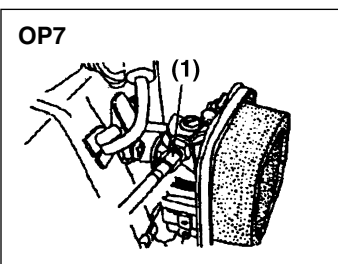

(1) Cable adjuster

■ ADJUSTING IDLING SPEED

1. When the engine tends to stop frequently at idling mode, turn the adjusting screw clockwise.

2. When the cutting head keeps rotating after releasing the trigger, turn the adjusting screw counter-clockwise.

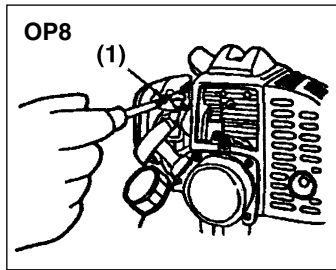

(1) Idle adjusting screw

NOTE

Warm up the engine before adjusting the idling speed.

■ CUTTING WORK

- By using the shoulder strap, hang the unit on your right side. Adjust the strap length so that the cutting head may become parallel to the ground.

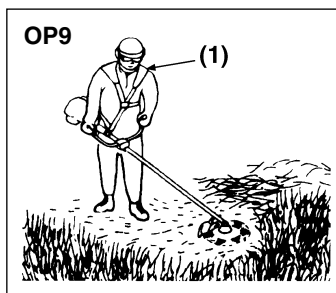

(1) Shoulder strap

- Choose a suitable recommended cutting attachment according to the object to be cut. Be sure to use ZENOAH genuine cutting attachments. Other cutting attachments are not included in the warranty.

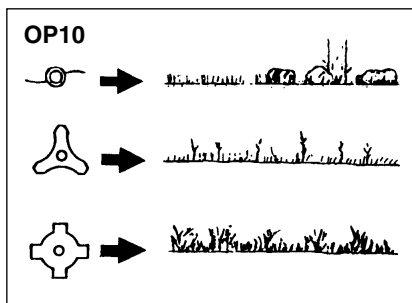

■ LINE HEAD USAGE

⚠ WARNING

1. Always wear eye protection such as safety goggles. Never lean over the rotating cutting head. Rocks or other debris could be thrown into

7. Operation

- eyes and face and cause serious personal injury.
- 2. Keep the debris guard attached in place at all times when the unit is operated.

TRIMMING GRASS AND WEEDS

- Always remember that the TIP of the line does cutting. You will achieve better results by not crowding the line into the cutting area. Allow the unit to trim at its own pace.
1. Hold the unit so the head is off the ground and is tilted about 20 degrees toward the sweep direction.
 2. Use full throttle when cutting.
 3. You can avoid thrown debris by sweeping from your left to the right.
 4. Use a slow, deliberate action to cut heavy growth. The rate of cutting motion will depend on the material being cut. Heavy growth will require slower action than will light growth.
 5. Never swing the unit so hard as you are in danger of losing your balance or control of the unit.
 6. Try to control the cutting motion with the hip rather than placing the full workload on the arm and hands.
 7. Take precautions to avoid wire, grass and dead, dry, long-stem weeds from wrapping around the head shaft. Such materials can stall the head and cause the clutch to slip, resulting in damage to the clutch system if repeated frequently.

ADJUSTING THE LINE LENGTH

- Your brushcutters is equipped with a semi- auto type nylon line head that allows the operator to advance the line without stopping the engine. When the line becomes short, lightly tap the head on the ground while running the engine at full throttle.
- Each time the head is bumped, the line advance about 1 inch(25.4 mm). For better effect, tap the head on bear ground or hard soil. Avoid bumping in thick, tall grass as the engine may stall by overload.

8. Maintenance

⚠ WARNING

Make sure that the engine has stopped and is cool before performing any service to the machine. Contact with moving cutting head or hot muffler may result in a personal injury.

■ AIR FILTER

The air filter, if clogged, will reduce the engine performance. Check and clean the filter element in warm, soapy water as required. Dry completely before installing. If the element is broken or shrunk, replace with a new one.

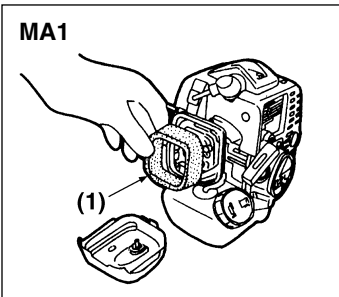

(1) Air filter

■ FUEL FILTER

When the engine runs short of fuel supply, check the fuel cap and the fuel filter for blockage.

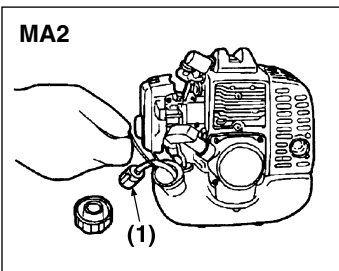

(1) Fuel filter

■ SPARK PLUG

Starting failure and misfiring are often caused by a fouled spark plug. Clean the spark plug and check that the plug gap is in the correct range. For a replacement plug, use the correct type specified by ZENOAH.

REPLACEMENT PLUG IS A NGK BPMR7A.

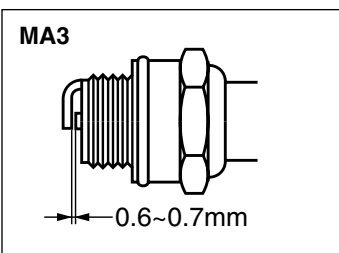

ⓘ IMPORTANT

- Note that using any spark plug other than those designated may result in the engine failing to operate properly or in the engine becoming overheated and damaged.
- To install the spark plug, first turn the plug until it is finger tight, then tighten it a quarter turn more with a socket wrench.

Tightning torque: 9.8~11.8N.m. (1.0~1.2kgm))

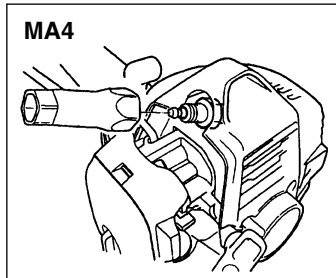

■ GEAR CASE

- The reduction gears are lubricated by multipurpose, lithium-based grease in the gear case. Supply new grease every 25 hours of use or more often depending on the job condition.
- Remove the bolt opposite to the grease nipple before installing new grease to arrange for old grease to exit.

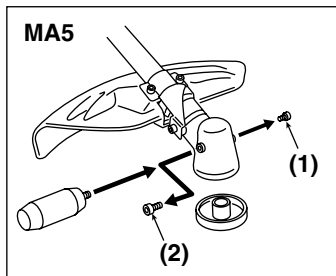

(1) Bolt
(2) Grease nipple

■ INTAKE AIR COOLING VENT

⚠ WARNING

- Never touch the cylinder, muffler, or spark plugs with your bare hands immediately after stopping the engine. The engine can become very hot when in operation, and doing so could result in severe burns.
- When checking the machine to make sure that it is okay before using it, check the area around the muffler and remove any wood chips or leaves which have attached themselves to the brushcutter. Failing to do so could cause the muffler to become overheated and that in turn

8. Maintenance

could cause the engine to catch on fire. Always make sure that the muffler is clean and free of wood chips, leaves, and other waste before use.

- Check the intake air cooling vent and the area around the cylinder cooling fins after every 25 hours of use for blockage, and remove any waste which has attached itself to the brushcutter. Note that it is necessary to remove the engine cover shown in in order to be able to view the upper part of the cylinder.

ⓘ IMPORTANT

If waste gets stuck and causes blockage around the intake air cooling vent or between the cylinder fins, it may cause the engine to overheat, and that in turn may cause mechanical failure on the part of the brushcutter.

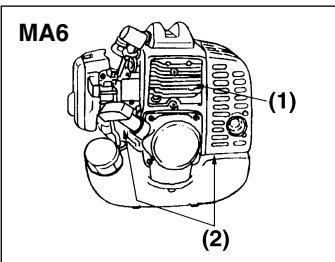

- (1) Cylinder
- (2) Intake air cooling vent

■ MUFFLER

⚠ WARNING

- Inspect periodically, the muffler for loose fasteners, any damage or corrosion. If any sign of exhaust leakage is found, stop using the machine and have it repaired immediately.
- Note that failing to do so may result in the engine catching on fire.

■ PROCEDURES TO BE PERFORMED AFTER EVERY 100 HOURS OF USE

1. Remove the muffler, insert a screwdriver into the vent, and wipe away any carbon buildup. Wipe away any carbon buildup on the muffler exhaust vent and cylinder exhaust port at the same time.
2. Tighten all screws, bolts, and fittings.
3. Check to see if any oil or grease has worked its way in between the clutch lining and drum, and if it has, wipe it away using oil-free, lead-free gasoline.

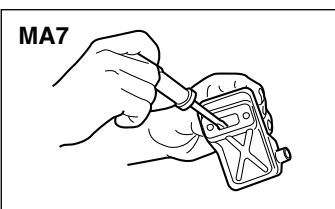

■ MAINTENANCE BEFORE STORAGE

- Old fuel left in the carburetor may cause starting failure. When a series of operation finished, make sure to empty the fuel tank and drain the carburetor.
- Check all parts and the functions. If the failed or damaged parts have been found, replace them with new ones.

■ MAINTENANCE BEFORE LONG-TERM STORAGE

⚠ WARNING

This machine is highly inflammable.

- When you take fuel out, keep the fuel tank well away from flames.
- Be careful not to spill the fuel, and completely wipe off all fuel spills.

ⓘ IMPORTANT

- If you will not use the machine for a long time (two months or more), take out the fuel from the fuel tank and carburetor. If you leave the fuel tank and carburetor filled with fuel for a long time, the fuel might deteriorate and clog the inside of the carburetor, thus causing engine problems (such as wrong start or insufficient output).
- When storing the machine for a long time, loosen the cap of the fuel tank slightly. Excessive tightening of the cap might deform its packing over time.

1. Brush off dirt from the machine, and check the damage or slack of each part. If you find any abnormal part, repair it completely ready for the next time the machine is used.
2. Extract fuel from the fuel tank, switch on the engine, and leave it running until it stops naturally.
3. Remove the spark plug, and pour 1 to 2 ml of 2-cycle oil into the engine. Draw the starter rope two to three times, set the plug back, and stop it at the contraction position.
4. Supply some grease to the gear case, and apply anti-rust oil to the metal parts such as the throttle wire.
5. Apply a little oil to the blade, put the cover on the blade, and keep the machine in a safe place away from heat and humidity.

9. Trouble shooting

PHENOMENON	MAIN CAUSE	MEASURES
The engine does not start.	• Bad fuel (different quality, deterioration)	• Replace it with normal fuel (page 11).
	• Excessive sucking of fuel	• Open the choke, open the throttle full open, and pull out the rope repeatedly (page 12).
	• Clogging of the muffler exhaust vent	• Clean the muffler (page 16).
	• Contamination of the spark plug electrodes, Short-circuit or breaking of a wire	• Clean the electrodes or replace the plug (page 15☆).
The engine does not accelerate.	• Bad fuel (different quality, deterioration)	• Replace it with normal fuel (page 11).
	• Clogging of the muffler exhaust vent	• Clean the muffler (page 16).
The engine stalls when the throttle is returned to its original position.	• The idling revolution speed is too low.	• Readjust the idling adjustment screw (page 13).
The engine rotation speed changes.	• Clogging of the fuel filter	• Clean or replace the fuel filter (page 15☆).
Abnormal vibration	• Deformation or damage of the blade	• Replace the blade (page 10☆).
Deterioration of fuel consumption	• Clogging of the air cleaner	• Clean the air cleaner (page 15).
	• Blunt blade	• Replace the blade (page 10☆).
	• Bad lubrication of the gear case	• Supply grease (page 15).

- When the symptoms in the left column do not improve after taking the measures in the right column, please contact the shop where you bought this product.
- For the measures marked with ☆, please buy ZENOAH's genuine parts at the shop where you bought this product.

▲ WARNING

- **Do not modify or disassemble the machine. Modification or disassembly of the machine might cause the machine to be damaged during operation, or cause an unexpected accident due to the leakage of fuel or malfunction of the machine.**
- **When you carry out inspection or maintenance of the machine, keep the machine clear of fire (such as a lit cigarette). Otherwise, the fuel might catch fire.**
- **Use ZENOAH's genuine or dedicated tightening parts (bolts, nuts and screws). Use of other manufacturers' parts might damage the machine, or cause an unexpected accident due to parts falling off while the machine is in operation.**

10. Disposal

- When you dispose of the machine, do not disassemble the machine.
- When you dispose of the machine, fuel, oil, be sure to follow your local regulations.

Limited warranty

Should any failure occur on the product under normal operating conditions within the applicable warranty period, the failed part will be replaced or repaired free of charge by a ZENOAH authorized dealer.

WARRANTY PERIOD: Six (6) months after purchased by end-user subject to 12 months from produced month. (30 days if used for rental purpose)

THE PURCHASER SHALL BEAR COSTS OF TRANSPORTING THE UNIT TO AND FROM THE ZENOAH DEALER.

THE PURCHASER SHALL NOT BE CHARGED FOR DIAGNOSTIC LABOR WHICH LEADS TO THE DETERMINATION THAT A WARRANTED PART IS DEFECTIVE, IF THE DIAGNOSTIC WORK IS PERFORMED AT THE ZENOAH DEALER.

THE PURCHASER OR OWNER IS RESPONSIBLE FOR THE PERFORMANCE OF THE REQUIRED MAINTENANCE AS DEFINED BY THE MANUFACTURER IN THE OWNER/OPERATOR MANUAL.

ANY WARRANTED PART WHICH IS NOT SCHEDULED FOR REPLACEMENT AS REQUIRED MAINTENANCE, OR WHICH IS SCHEDULED ONLY FOR REGULAR INSPECTION TO THE EFFECT OF REPAIR OR "REPLACE AS NECESSARY" SHALL BE WARRANTED FOR THE WARRANTY PERIOD. ANY WARRANTED PART WHICH IS SCHEDULED FOR REPLACEMENT AS REQUIRED MAINTENANCE SHALL BE WARRANTED FOR THE PERIOD OF TIME UP TO THE FIRST SCHEDULED REPLACEMENT POINT FOR THE PART.

ANY REPLACEMENT PART THAT IS EQUIVALENT IN PERFORMANCE AND DURABILITY MAY BE USED IN NON-WARRANTY MAINTENANCE OR REPAIRS, AND SHALL NOT REDUCE THE WARRANTY OBLIGATION OF THE COMPANY.

THE COMPANY IS LIABLE FOR DAMAGES TO OTHER ENGINE COMPONENTS CAUSED BY THE FAILURE OF A WARRANTED PART STILL UNDER WARRANTY.

THE WARRANTY DOES NOT APPLY TO THOSE UNITS WHICH HAVE BEEN DAMAGED BY NEGLIGENCE OF INSTRUCTION LISTED IN THE

OWNER/OPERATOR MANUAL FOR PROPER USE AND MAINTENANCE OF THE UNITS ACCIDENT MISHANDLING, ALTERATION, ABUSE, IMPROPER LUBRICATION, USE OF ANY PARTS OR ACCESSORIES OTHER THAN THOSE SPECIFIED BY THE COMPANY, OR OTHER CAUSES BEYOND THE COMPANY'S CONTROL.

THIS WARRANTY DOES NOT COVER THOSE PARTS REPLACED BY NORMAL WEAR OR HARMLESS CHANGES IN THEIR APPEARANCE.

THERE ARE NO OTHER EXPRESS WARRANTIES.

ANY IMPLIED WARRANTY is limited to the duration of the limited warranty. Otherwise, this limited warranty is in lieu of all other expressed or implied warranties, including any warranty of **FITNESS FOR A PARTICULAR PURPOSE OR USE** and any implied warranty **MERCHANTABILITY** otherwise applicable to this product.

LIABILITIES FOR INCIDENTAL OR CONSEQUENTIAL DAMAGE UNDER ANY AND ALL WARRANTIES ARE EXCLUDED.

IF YOU NEED TO OBTAIN MORE INFORMATION, PLEASE CALL YOUR NEAREST SERVICE CENTER, OR CHECK PLEASE ZENOAH WEB SITE:
<http://www.zenoah.net>

To Dealer: Please complete the following form at time of sale.

Product Model: ZENOAH <input type="checkbox"/> KAM-402	Equipment No.:
	Engine No.:
Date of Purchase: D / M / Y	Use: <input type="checkbox"/> Private
	<input type="checkbox"/> Professional
	<input type="checkbox"/> Rental
Purchaser: Name:	
Address/Phone:	
Dealer: Name:	
Address/Phone:	

To Purchaser: When your unit requires any repair, please bring or send it to the dealer with this sheet attached.



Husqvarna Zenoah Co., Ltd.

1-9, Minamidai, Kawagoe-city, Saitama, 350-1165 Japan

Free Manuals Download Website

<http://myh66.com>

<http://usermanuals.us>

<http://www.somanuals.com>

<http://www.4manuals.cc>

<http://www.manual-lib.com>

<http://www.404manual.com>

<http://www.luxmanual.com>

<http://aubethermostatmanual.com>

Golf course search by state

<http://golfingnear.com>

Email search by domain

<http://emailbydomain.com>

Auto manuals search

<http://auto.somanuals.com>

TV manuals search

<http://tv.somanuals.com>