



# Use, Care, and Installation Guide

## Breeze I, II

AK1124S, W

AK1100S, W, B , Q

AK1136S, W, B , Q

AK1200S, W, B , Q

AK1236S, W, B , Q

Model number: \_\_\_\_\_

Serial number: \_\_\_\_\_

0AK11-70001 REV. 06/05 © Zephyr Corporation.





SAFETY NOTICE..... 2  
LIST OF MATERIALS..... 3

INSTALLATION

- Ducting Calculation Sheet ..... 4
- Mounting Height and Clearance ..... 5
- Ducting ..... 6
- Specifications ..... 7
- Preparing Electrical and Ducting ..... 8
- Air Recirculating ..... 9
- Mounting the Hood ..... 10

FEATURES & CONTROLS

- Controls Overview ..... 11

MAINTENANCE

- Cleaning ..... 12
- Lights ..... 12

TROUBLE SHOOTING..... 13  
WARRANTY..... 14  
LIST OF ACCESSORIES/PARTS..... 15  
EXPLODED VIEW DIAGRAM..... 16-21



**WARNING**

TO REDUCE THE RISK OF FIRE OR ELECTRIC SHOCK, DO NOT USE THIS FAN WITH ANY SOLID-STATE SPEED CONTROL DEVICE.

**WARNING**

TO REDUCE THE RISK OF FIRE, ELECTRIC SHOCK, OR INJURY TO PERSONS, OBSERVE THE FOLLOWING:

- a. Use this unit only in the manner intended by the manufacturer. If you have questions, contact the manufacturer.
- b. Before servicing or cleaning unit, switch power off at service panel and lock the service disconnecting means to prevent power from being switched on accidentally.  
When the service disconnecting means cannot be locked, securely fasten a prominent warning device, such as tag, to the service panel.

**CAUTION**

For General Ventilating Use Only. Do not Use to Exhaust Hazardous or Explosive Materials and Vapors. Take care when using cleaning agents or detergents. Suitable for use in household cooking area.

**WARNING**

TO REDUCE THE RISK OF A RANGE TOP GREASE FIRE:

- a. Never leave surface units unattended at high settings. Boilovers cause smoking and greasy spillovers that may ignite. Heat oils slowly on low or medium settings.
- b. Always turn hood ON when cooking at high heat or when cooking flambeing food (i.e. Crepes Suzette, Cherries Jubilee, Peppercorn Beef Flambe)
- c. Clean ventilating fans frequently Grease should not be allowed to accumulate on fan or filter.
- d. Use proper pan size. Always use cookware appropriate for the size of the surface element.
- e. Keep fan, filters and grease laden surfaces clean.
- f. Use high setting on hood only when necessary.
- g. Don't leave hood unattended when cooking.
- h. Always use cookware and utensils appropriate for the type of and amount of food being prepared.

**WARNING**

TO REDUCE THE RISK OF INJURY TO PERSONS IN THE EVENT OF A RANGE TOP GREASE FIRE, OBSERVE THE FOLLOWING:

- a. SMOTHER FLAMES with a close-fitting lid, cookie sheet, or metal tray, then turn off the burner. BE CAREFUL TO PREVENT BURNS. If the flames do not go out immediately, EVACUATE AND CALL THE FIRE DEPARTMENT.
- b. NEVER PICK UP A FLAMING PAN - You may be burned.
- c. DO NOT USE WATER, including wet dishcloths or towels - a violent steam explosion will result.
- d. Use an extinguisher ONLY if:
  - 1. You know you have a class ABC extinguisher, and you already know how to operate it.
  - 2. The fire is small and contained in the area where it started.
  - 3. The fire department is being called.
  - 4. You can fight the fire with your back to an exit.
  - 5. Based on "Kitchen Fire Safety Tips" published by NFPA.

**WARNING**

TO REDUCE THE RISK OF FIRE, ELECTRIC SHOCK OR INJURY TO PERSONS, OBSERVE THE FOLLOWING:

- a. Installation Work and Electrical Wiring Must be Done by Qualified Person (s) In Accordance with all Applicable Codes and Standards, Including Fire-Rated Construction.
- b. Sufficient air is needed for proper combustion and exhausting of gases through the flue (chimney) of fuel burning equipment to prevent back drafting. Follow the heating equipment manufacturer's guideline and safety standards such as those published by the National Fire Protection Association (NFPA), and the American Society for Heating, Refrigeration, and Air Conditioning Engineers (ASHRAE) and the local code authorities
- c. When cutting or drilling into wall or ceiling, do not damage electrical wiring and other hidden utilities.
- d. Ducted fans must always vent to the outdoors.
- e. If this unit is to be installed over a tub or shower, it must be marked as appropriate for the application and be connected to a GFCL (Ground Fault Interrupter protected branch circuit).
- g. NEVER place a switch where it can be reached from a tub or shower.
- h. Make sure the power is off before installing, wiring or maintenancing.

**WARNING**

TO REDUCE THE RISK OF FIRE, USE ONLY METAL DUCTWORK.

**CAUTION**

To reduce risk of fire and to properly exhaust air, be sure to duct air outside - Do not vent exhaust air into spaces within walls or ceilings or into attics, crawl spaces or garages.











- 1 - Hood
- 2 - Light bulbs R16 40W
- 2 - Metallic Filters
- 1 - 3 1/4" x 10" rectangular starting collar with damper
- 1 - Hardware packet containing:
  - 3 - Wire connector caps 18g
  - 4 - Wood Screws 2"
  - 4 - Wood Screws 1 1/2"
  - 4 - Wood Screws 1"
  - 4 - Washers











NO DUCTING IS INCLUDED

\* **Note** Zephyr recommends using 50LB EZ anchors if mounting hood onto drywall. These are not provided, but are readily available at most hardware stores.



**Installation - Ductwork Calculation Sheet**

| Duct pieces   | Equivalent number length x used = | Total |
|---|-----------------------------------|-------|
|  3 1/4" x 10" Rect., straight                          | 1 Ft. x ( ) =                     | Ft.   |
|  6" Round, straight                                    | 1 Ft. x ( ) =                     | Ft.   |
|  7" Round, straight                                    | 1 Ft. x ( ) =                     | Ft.   |
|  3 1/4" x 10" Rect. 90° elbow                          | 15 Ft. x ( ) =                    | Ft.   |
|  3 1/4" x 10" Rect. 45° elbow                          | 9 Ft. x ( ) =                     | Ft.   |
|  3 1/4" x 10" Rect. 90° flat elbow                     | 24 Ft. x ( ) =                    | Ft.   |
|  3 1/4" x 10" Rect. wall cap with damper             | 30 Ft. x ( ) =                    | Ft.   |
|  3 1/4" x 10" Rect. to 6" round transition           | 5 Ft. x ( ) =                     | Ft.   |
|  3 1/4" x 10" Rect. to 6" round transition 90° elbow | 15 Ft. x ( ) =                    | Ft.   |
|  6" Round, 90° elbow                                 | 15 Ft. x ( ) =                    | Ft.   |
|  6" Round, 45° elbow                                 | 9 Ft. x ( ) =                     | Ft.   |
| Subtotal column 1 =   |                                   | Ft.   |

| Duct pieces   | Equivalent number length x used = | Total |
|---|-----------------------------------|-------|
|  6" Round wall cap with damper                         | 30 Ft. x ( ) =                    | Ft.   |
|  6" Round, roof cap                                    | 30 Ft. x ( ) =                    | Ft.   |
|  6" round to 3 1/4" x 10" rect. transition             | 1 Ft. x ( ) =                     | Ft.   |
|  6" round to 3 1/4" x 10" rect. transition 90° elbow   | 16 Ft. x ( ) =                    | Ft.   |
|  7" Round, 90° elbow                                   | 15 Ft. x ( ) =                    | Ft.   |
|  7" Round, 45° elbow                                   | 9 Ft. x ( ) =                     | Ft.   |
|  7" Round wall cap with damper                       | 30 Ft. x ( ) =                    | Ft.   |
|  7" Round, roof cap                                  | 30 Ft. x ( ) =                    | Ft.   |
|  7" round to 3 1/4" x 10" rect. transition           | 8 Ft. x ( ) =                     | Ft.   |
|  7" round to 3 1/4" x 10" rect. transition 90° elbow | 15 Ft. x ( ) =                    | Ft.   |
| Subtotal column 2 =   |                                   | Ft.   |
| Subtotal column 1 =   |                                   | Ft.   |
| Total ductwork =  |                                   | Ft.   |

Maximum Duct Length: For satisfactory air movement, the total duct length of a 3 1/4" x 10" rectangular, 6" or 7" diameter round duct should not exceed 100 equivalent feet.

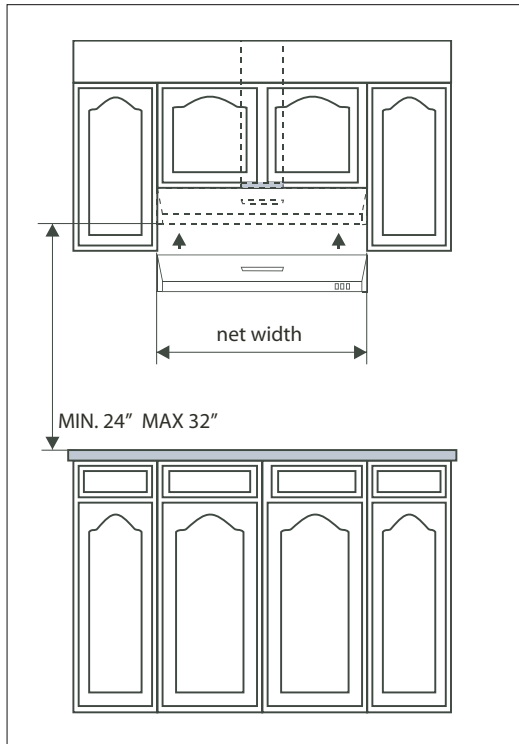

Minimum mount height between range top to hood bottom should be no less than 24".

Maximum mount height should be no higher than 32".

It is important to install the hood at the proper mounting height. Hoods mounted too low could result in heat damage and fire hazard; while hoods mounted too high will be hard to reach and will lose its performance and efficiency.

If available, also refer to range manufacturer's height clearance requirements and recommended hood mounting height above range. Always check your local codes for any differences.

| Call Out Size | Net Width |
|---------------|-----------|
| 24"           | 23 3/4"   |
| 30"           | 29 3/4"   |
| 36"           | 35 3/4"   |

## DUCTING

A minimum 3-1/4 x 10" rectangular duct must be used to maintain maximum air flow efficiency.

Always use rigid type metal ducts only. Flexible ducts could restrict air flow by up to 50%.

Use calculation worksheet to compute total duct work.

ALWAYS, when possible, reduce the number of transitions and turns. If a reducer is used, install a long reducer instead of a pancake reducer. Reduce duct size as far away from opening as possible.

If turns or transitions are required: Install as far away from opening and as far apart, between 2, as possible.

### Minimum Duct Size:

Rectangular- 3-1/4 x 10" minimum (rear or top)

### DAMAGE-SHIPMENT / INSTALLATION:

- Please fully inspect unit for damage before installation.
- If the unit is damaged in shipment, return the unit to the store in which it was bought for repair or replacement.
- If the unit is damaged by the customer, repair or replacement is the responsibility of the customer.
- If the unit is damaged by the installer (if other than the customer), repair or replacement must be made by arrangement between customer and installer.

# Installation - Ducting

## WARNING FIRE HAZARD

NEVER exhaust air or terminate duct work into spaces between walls, crawl spaces, ceiling, attics or garages. All exhaust must be ducted to the outside, unless using the recirculating option.

Use single wall rigid Metal ductwork only.

Fasten all connections with sheet metal screws and tape all joints w/ certified Silver Tape or DuctTape.

Some Ducting Options:

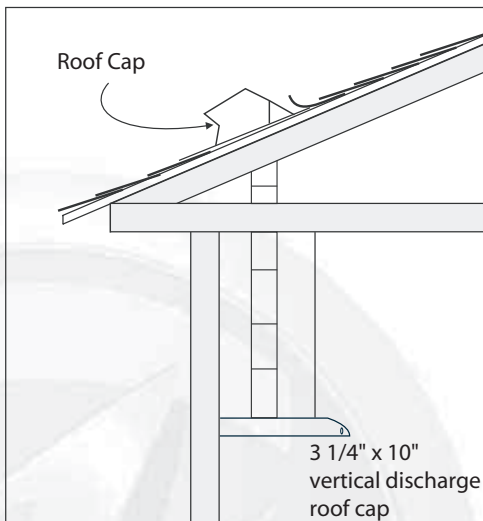
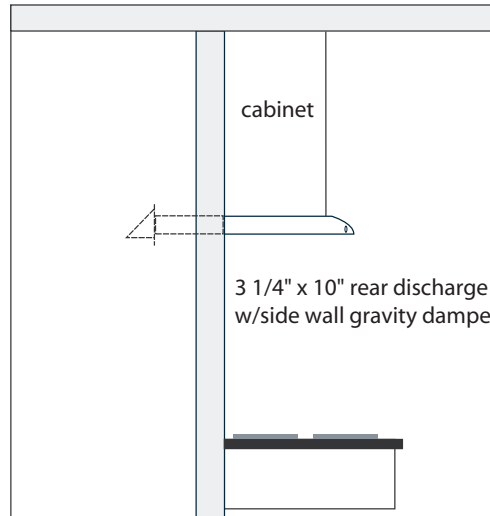



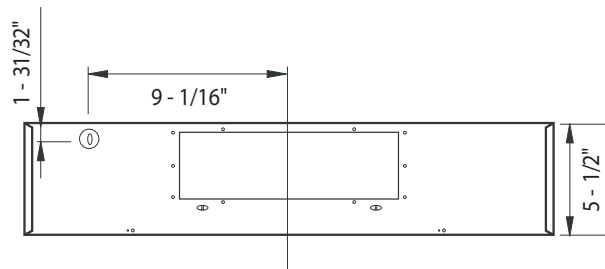
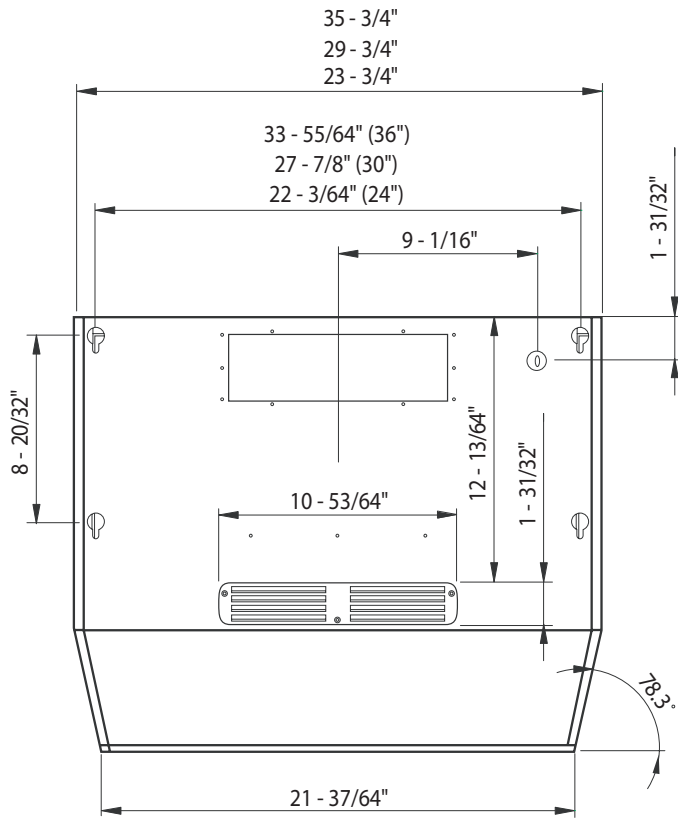

# Installation - Specifications

# Installation - Preparing Electrical and Ducting

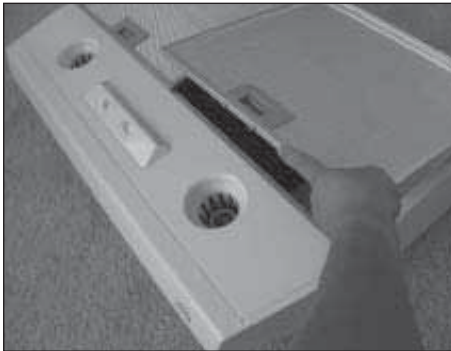

1. Remove filters.



2. Remove cover from junction box to gain access to the electrical wiring.

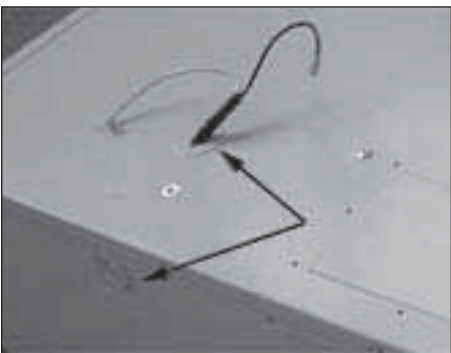

3. If using a cable lock (not provided) pry open the desired electrical knockout, either on the top or the back. Feed the wires through the 3/4" cable lock. Note: Some local codes require the use of a cable lock, check your local codes for this information.



4. If using hood in air recirculation mode, skip steps 4 and 5 pry open the desired 3 1/4" x 10" ducting knockout, either horizontal or vertical.



5. Attach the 3 1/4" X 10" starting collar with damper to the duct opening you exposed.

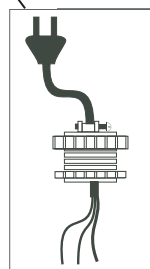

Cable lock example

\* If you are ducting the air out of your home, skip these steps.



An air recirculation kit (optional) must be purchased in order to use the hood in air recirculation mode.

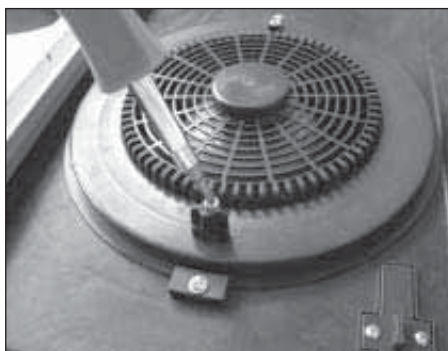

1. Attach each of the (2) spring loaded clips to the safety grill body. Do this by inserting the screw to the spring and into the bracket. Then screw it into the safety grill body.



2. Insert the carbon filter into the carbon filter holder and place it over the safety grill.



3. Secure the carbon filter holder to the safety grill body by slightly lifting and twisting the spring loaded clip. Make sure it presses against the lip of the carbon filter holder securely.



4. Unscrew and remove the air diverter plate.



5. Finally, remove the cover plate at the front of the hood on top. Replace it with the air recirculation cover plate.

# Installation - Mounting the Hood

## ELECTRICAL - WARNING

All Electrical work must be performed by qualified electrician or person with similar technical know how and background.

For personal safety, remove house fuse or open circuit breaker before beginning installation.

Do not use extension cord or adapter plug with this appliance.

Follow National electrical codes or prevailing local codes and ordinances.

### Electrical Supply:

This appliance requires a 120V 60Hz electrical supply, and connected to an individual, properly grounded branch circuit, protected by a 15 or 20 ampere circuit breaker or time delay fuse. Wiring must be 2 wire w/ ground. Please refer to Electrical Diagram labeled on product.

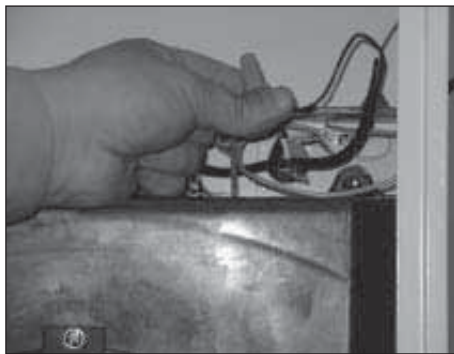

2. Attach house electrical wiring to hood wiring. Make sure the power source is turned off before working with any electrical wiring.



4. Attach duct work. Use aluminum duct tape to make joints secure and air tight. NOTE: This step is not necessary if hood is in air recirculation mode.



1. Temporarily position the hood in the desired mounting location. Measure and mark the mounting holes, duct and electrical access locations with a pencil. Remove hood and drill/cut out the required openings for duct and electrical access.



3. Hang hood from mounting screws provided. Slide hood toward wall until mounting screws are engaged in narrow end of keyholes. Tighten mounting screws securely. CAUTION: Do not push on safety grill when installing, this may result in damage to the motor.



5. If not already done, install light bulbs by screwing in clockwise.

## Breeze I, AKIIXX

- ① Blower On/Off/Speed Selection    ② Lights On/Off/Dim

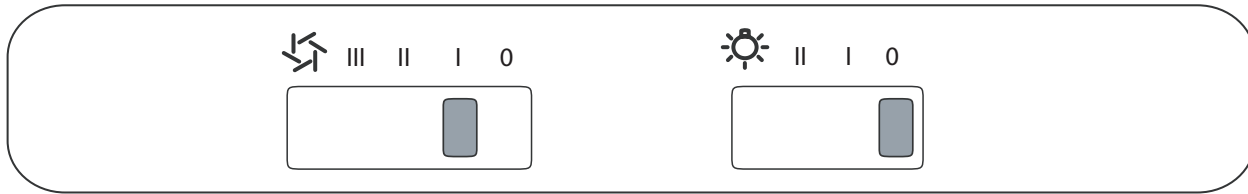

- ① Blower On/Off/Speed Selection  
This switch turns the blower on and off and controls the speed selection. 0 is off, I is low speed, II is medium speed and III is high speed.
- ② Lights On/Off/Dim  
0 is off, I is bright, II is dim.

## Breeze II, AKI2XX

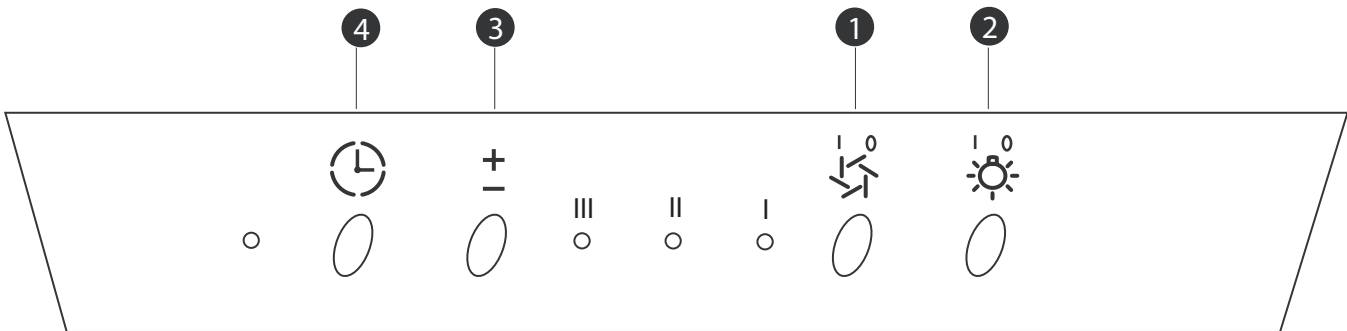

- ① On/Off  
This button turns the motors on and off. It also shuts off power to the whole hood. If the lights are on and this button is pushed, they will also turn off.
- ② Lamp  
This button turns the lights on, off and also dims them. Press once to turn them on bright, again for dim and one more time to shut them off.
- ③ Speed  
This button will change the speed setting of the motors. By pushing it you will change the speeds from low, to medium, to high.
- ④ Delay Off  
This button will put the hood into delay off mode. When pushed, the hood will switch to the lowest speed and the entire hood will shut down after 5 minutes.

## Maintenance - Cleaning and Replacing Light Bulbs

### Aluminum Mesh Filters:

Clean frequently using hot water and a mild, non abrasive detergent. Filters are dishwasher safe.

### Carbon Filters:

Clean carbon filters holder frequently with a damp cloth and mild detergent. DO NOT immerse carbon filter in water or put in dishwasher. The carbon filters should be replaced every 4 to 6 months under normal use.

### Hood Surface:

Remove filters. Use a damp cloth and a mild detergent to wipe all residue-laden surfaces. Use care when cleaning fan blades, it must not become bent or misaligned. DO NOT ALLOW WATER TO ENTER MOTOR. Make sure all surfaces are completely dry before re-installing filters and using hood.

### Replacing Light Bulbs:

**CAUTION:** Light bulbs become extremely hot when turned on. DO NOT touch bulbs until switched off and cooled. Touching hot bulbs may cause serious burns.

Hood comes with (2) R16 40W incandescent bulbs. You may also use (2) PAR20 35W or 50W halogen light bulbs. (purchased separately)

Remove bulb by unscrewing counter-clockwise. Use a suction cup or rubber/latex glove to grip the bulb if removing bulb is difficult.



|   |   |
|---|---|
| 1. Upon completion of installation nothing works.                                       | Check if unit has been plugged in, make sure that all power has been turned back on and all electrical wiring are properly connected.   |
| 2. Light is on but blowers are not turning at all or seems to be scraping on something. | Blower blade unit might have been mounted too low and scraping the bottom or jammed. Loosen hex screw on blade unit and adjust to proper height.  |
| 3. When blowers are on, something seems to be loose and spinning around inside.         | There might have been foreign particles left within the discharge opening or rocks, leaves, branches, etc. that might have fell in from old duct work. Disconnect duct work to inspect and remove any foreign particles.  |
| 4. Vibration when blowers are on  | Unit might not have been secured properly on cabinet. Or cabinet might need to be further secured into studs on wall.   |
| 5. Blowers noise  | Our blowers are designed to perform up to 850 cfm. A properly functioning motor itself should be relatively quiet. Nevertheless, due to vacuum created by the suction, noise level up to 6 sones will be generated when both blower unit is turned on at its maximum speed. Employing low speeds will suffice moderate cooking such as steaming, broiling etc.  |
| 6. Light is not working   | Light bulb might need to be replaced. On some instances, the fragile bulb could have been damaged during the shipping process. Replace light bulb.  |
| 7. Blowers seemed weak  | Check duct size used, duct size should be at least 3 1/4" x 10". Range hood WILL NOT function properly with the insufficient duct size.<br>Check if duct is clogged or if damper unit is not opening properly. A tight mesh on a side wall cap unit might also cause restriction to the air flow.<br>Use a damper type sidewall cap.<br>Reduce the number of elbows and length of duct work or increase duct size.<br>Check if all joints are properly connected, sealed and taped. |
| 8. Cooking fumes and smoke dissipates before it reaches the blower.                     | Check if unit is installed at the recommended height. The range hood should also be able to cover the entire cooking area from left to right and most areas from rear to front.<br>Open doors and windows might also distract air flow before it reaches the blowers.<br>Make sure blowers are on high speed for heavy cooking.   |

# Warranty

TO OBTAIN SERVICE UNDER WARRANTY:  
or any Service Related Questions, please call:  
1-888-880-8368

Staple your receipt here.  
Proof of the original purchase  
date is needed to obtain service  
under the warranty.

TO OBTAIN SERVICE UNDER WARRANTY: You must present proof of original purchase date.  
Please keep a copy of your dated proof of purchase (sales slip) in order to obtain service under warranty.

### One Year Service Repair Warranty:

For one year from date of original purchase, we will provide free of charge, service labor to repair any failed parts or components due to manufacturing defects.

### Ten Years Parts Warranty:

For ten years from date of original purchase, we will provide free of charge, nonconsumable replacement parts or components that failed due to manufacturing defects. Consumable parts not covered by this warranty include: Light Bulbs, Metal and Carbon Filters.

### Who is Covered:

This warranty is extended to the original purchaser for products purchased for ordinary home use in the 48 mainland states, Hawaii and Washington D.C. In Canada and Alaska, this warranty is Limited. There might be costs associated with shipping the products to our designated service locations or you might need to pay service technician's travel costs, to have the appliance repaired in-home.

### This Warranty will be Voided when:

Product damaged through negligence, misuse, abuse, accident. Improper installation and failure to follow installation instructions. When product is used commercially or other than its intended purpose. Damaged because of improper connection with equipment of other manufacturers. Repaired or modified by anyone other than Zephyr's Authorized Agents.

### What is Not Covered:

Consumable parts such as light bulbs, filters, and fuses. Services outside of service area and the labor cost incurred in connection with the removal, shipping and reinstallation cost, nor does it cover any other contingent expenses. The natural wear of finish, and wear due to improper maintenance, use of corrosive and abrasive cleaning products, pads, and oven cleaner products. Chips, dents or cracks due to abuse, misuse, freight damage, or improper installation. Service trips to your home to teach you how to use the product. Damage of product caused by accident, fire, floods or act of God.

This warranty is valid in the United States and Canada. It is non-transferable and applies only to the original purchaser and does not extend to subsequent owners of this product. Any applicable implied warranties, including the warranty of merchantability, are limited in duration to a period of express warranty as provided herein beginning with the date of original purchase at retail and, no warranties, whether express or implied, shall apply to this product thereafter.

Have your product proof of purchase with date ready for warranty issues.  
Or write to:

Zephyr Corporation  
Service and Warranty Department  
395 Mendell Street  
San Francisco, CA 94124



| Description                             | Part#       |
|---|-------------|
| Light Bulb (R16 40W)                    | Z0B002      |
| Light Bulb (PAR20 35W)                  | Z0B001      |
| Telescopic Back Splash 30" SS           | AK0710      |
| Telescopic Back Splash 36" SS           | AK0716      |
| Air Recirculation Kit (w/carbon filter) | 0AK11-21001 |
| Carbon Filter Replacement               | 0AK11-20001 |
| Aluminum Replacement Filters, 24", 30"  | 0AK11-22001 |
| Aluminum Replacement Filters, 36"       | 0AK11-22002 |

To order parts, visit us online at : [www.zephyronline.com](http://www.zephyronline.com) and go to the parts store.  
Or call us at : 888-880-8368



# Exploded View Diagram - Breeze I

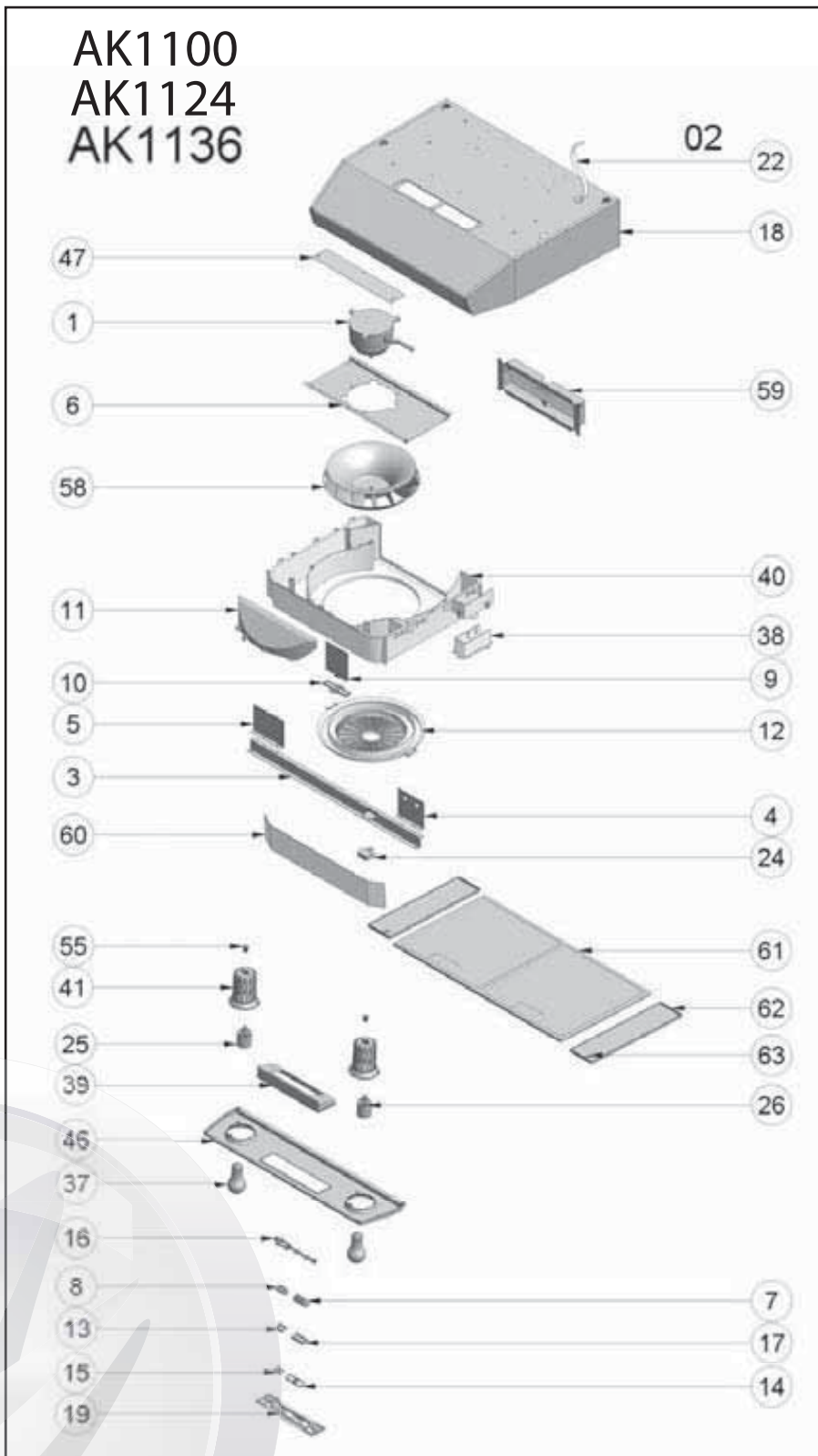

rev 0105

# Breeze I

Ak11xxB,S,W

Part Numbers - Breeze I

| Ref # | Part #      | Description                        | per Hood |
|-------|-------------|------------------------------------|----------|
| 1     | M038-1      | Motor                              | 1        |
| 3     | XP001211-14 | Panel, Support (AK1100x)           | 1        |
| 3     | XP001211-13 | Panel, Support (AK1124x)           | 1        |
| 3     | XP001211-14 | Panel, Support (AK1136x)           | 1        |
| 4     | XP001211-17 | Panel, Left (AK1100x)              | 1        |
| 4     | XP001211-16 | Panel, Left (AK1124x)              | 1        |
| 4     | XP001211-17 | Panel, Left (AK1136x)              | 1        |
| 5     | XP001211-20 | Panel, Right (AK1100x)             | 1        |
| 5     | XP001211-19 | Panel, Right (AK1124x)             | 1        |
| 5     | XP001211-20 | Panel, Right (AK1136x)             | 1        |
| 6     | XP001211-27 | Motor Holder                       | 1        |
| 7     | XP00613     | Switch, Motor                      | 1        |
| 8     | XP00613-1   | Switch, Light                      | 1        |
| 9     | XP018133    | Panel, Air Diverter                | 1        |
| 10    | XP018133-1  | Cover Panel, Air Diverter          | 1        |
| 11    | XP018133-2  | Cover, Blower Wheel                | 1        |
| 12    | XP018133-3  | Safety Grill                       | 1        |
| 13    | XP01868-01  | Gasket, Switch, Light (black)      | 1        |
| 13    | XP01868     | Gasket, Switch, Light (white)      | 1        |
| 14    | XP01868-04  | Cover Plate, Switch, Motor (black) | 1        |
| 14    | XP01868-03  | Cover Plate, Switch, Motor (white) | 1        |
| 15    | XP01868-07  | Cover Plate, Switch, Light (black) | 1        |
| 15    | XP01868-06  | Cover Plate, Switch, Light (white) | 1        |
| 16    | XP01868-10  | Switch Spacer (black)              | 1        |
| 16    | XP01868-09  | Switch Spacer (white)              | 1        |
| 17    | XP01868-12  | Gasket, Switch, Motor (black)      | 1        |
| 17    | XP01868-14  | Gasket, Switch, Motor (white)      | 1        |
| 19    | XP021174    | Cover Plate, Cotrols (black)       | 1        |
| 19    | XP021174-2  | Cover Plate, Controls (white)      | 1        |
| 22    | XP02746-3   | Electrical Wires                   | 1        |
| 24    | XP02811     | Capacitor                          | 1        |
| 25    | XP02909-3   | Light Socket, Left w/wire          | 1        |
| 26    | XP02909-4   | Light Socket, Right w/wire         | 1        |
| 37    | XP13804-2   | Bulb, R16 40W                      | 2        |
| 38    | XP14438-1   | Junction Box                       | 1        |
| 39    | XP14438-2   | Housing, Switch                    | 1        |
| 40    | XP14438-4   | Housing, Blower Wheel              | 1        |

# Part Numbers - Breeze I

|    |             |                                |   |
|----|-------------|--------------------------------|---|
| 41 | XP14438-5   | Housing, Light Socket (black)  | 2 |
| 41 | XP14438-3   | Housing, Light Socket (white)  | 2 |
| 46 | XP164190-24 | Panel, Light (AK1100B)         | 1 |
| 46 | XP001211-21 | Panel, Light (AK1100S)         | 1 |
| 46 | XP164190-20 | Panel, Light (AK1100W)         | 1 |
| 46 | XP164190-21 | Panel, Light (AK1124B)         | 1 |
| 46 | XP001211-23 | Panel, Light (AK1124S)         | 1 |
| 46 | XP164190-23 | Panel, Light (AK1124W)         | 1 |
| 46 | XP164190-24 | Panel, Light (AK1136B)         | 1 |
| 46 | XP001211-25 | Panel, Light (AK1136S)         | 1 |
| 46 | XP164190-26 | Panel, Light (AK1136W)         | 1 |
| 47 | XP164190-27 | Panel, Top (AK1100B)           | 1 |
| 47 | XP001211-28 | Panel, Top (AK1100S)           | 1 |
| 47 | XP164190-29 | Panel, Top (AK1100W)           | 1 |
| 58 | XP26501     | Blower Wheel                   | 1 |
| 59 | XP26601     | Collar, Rectangular Starting   | 1 |
| 60 | XP26603     | Cover Panel, Blower Wheel      | 1 |
| 61 | XP26701     | Metallic Filter (AK1100,1136)  | 2 |
| 61 | XP26701-1   | Metallic Filter (AK1124)       | 2 |
| 62 | XP164190-30 | Panel, Side Spacer (black)     | 2 |
| 62 | XP001211-30 | Panel, Side Spacer (stainless) | 2 |
| 62 | XP164190-31 | Panel, Side Spacer (white)     | 2 |
| 63 | XP26602     | Panel Latch                    | 2 |



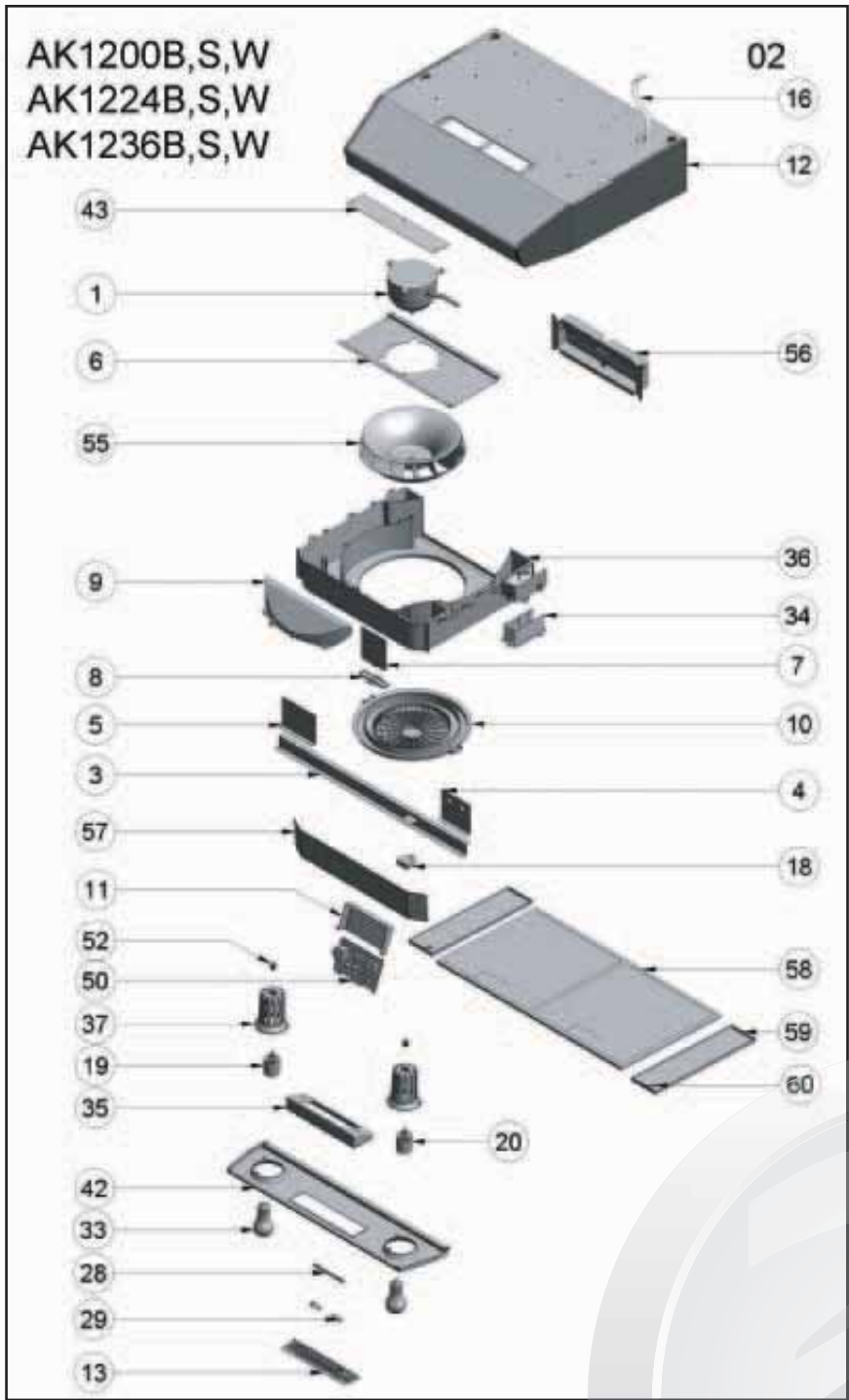

# Exploded View Diagram - Breeze II

rev:0105

# Breeze II

Ak12xxB,S,W

| Ref # | Part #      | Description                       | per Hood |
|-------|-------------|-----------------------------------|----------|
| 1     | M033        | Motor                             | 1        |
| 3     | XP001211-12 | Panel, Support (AK1200x)          | 1        |
| 4     | XP001211-15 | Panel, Right (AK1200x)            | 1        |
| 5     | XP001211-18 | Panel, Left (AK1200x)             | 1        |
| 6     | XP001211-27 | Motor Holder                      | 1        |
| 7     | XP018133    | Panel, Air Diverter               | 1        |
| 8     | XP018133-1  | Cover Panel, Air Diverter         | 1        |
| 9     | XP018133-2  | Cover, Blower Wheel               | 1        |
| 10    | XP018133-3  | Safety Grill                      | 1        |
| 11    | XP01869-12  | Cover, Control Board              | 1        |
| 13    | XP021174-3  | Cover Plate, Switch (AK12xxB,S)   | 1        |
| 13    | XP021174-4  | Cover Plate, Switch (AK12xxW)     | 1        |
| 16    | XP02746-3   | Power Cord                        | 1        |
| 18    | XP02802-3   | Capacitor                         | 1        |
| 19    | XP02909-3   | Light Socket w/Wire, Left         | 1        |
| 20    | XP02909-4   | Light Socket w/Wire, Right        | 1        |
| 28    | XP07002     | Plate, Switch Button              | 1        |
| 29    | XP07002-1   | Buttons, Push (AK12xxB,S)         | 4        |
| 29    | XP07002-2   | Buttons, Push (AK12xxW)           | 4        |
| 33    | XP13804-2   | Bulb, (R16 40W)                   | 2        |
| 34    | XP14438-1   | Junction Box                      | 1        |
| 35    | XP14438-2   | Housing, Switch                   | 1        |
| 36    | XP14438-4   | Housing, Blower Wheel (AK12xxB,S) | 1        |
| 36    | XP14438-3   | Housing, Blower Wheel (AK12xxW)   | 1        |
| 37    | XP14438-5   | Housing, Light Socket (AK12xxB,S) | 2        |
| 37    | XP14438-4   | Housing, Light Socket (AK12xxW)   | 2        |
| 42    | XP164190-18 | Panel, Light (AK1200B)            | 1        |
| 42    | XP001211-21 | Panel, Light (AK1200S)            | 1        |
| 42    | XP164190-20 | Panel, Light (AK1200W)            | 1        |
| 42    | XP164190-21 | Panel, Light (AK1224B)            | 1        |
| 42    | XP001211-23 | Panel, Light (AK1224S)            | 1        |
| 42    | XP164190-23 | Panel, Light (AK1224W)            | 1        |
| 42    | XP164190-24 | Panel, Light (AK1236B)            | 1        |
| 42    | XP001211-25 | Panel, Light (AK1236S)            | 1        |
| 42    | XP164190-26 | Panel, Light (AK1236W)            | 1        |
| 43    | XP164190-27 | Panel, Top (AK12xxB)              | 1        |
| 43    | XP001211-28 | Panel, Top (AK12xxS)              | 1        |
| 43    | XP164190-29 | Panel, Top (AK12xxW)              | 1        |

|           |             |                                     |   |
|-----------|-------------|-------------------------------------|---|
| <b>50</b> | XP19825     | Control Board                       | 1 |
| <b>55</b> | XP26501     | Blower Wheel                        | 1 |
| <b>56</b> | XP26601     | Collar, Rectangular Starting        | 1 |
| <b>57</b> | XP26603     | Cover Panel, Blower Wheel           | 1 |
| <b>58</b> | XP26701     | Metallic Filters (AK1200x, AK1236x) | 2 |
| <b>58</b> | XP26701-1   | Metallic Filters (AK1224x)          | 2 |
| <b>59</b> | XP164190-30 | Panel, Side Spacer (AK1236B)        | 2 |
| <b>59</b> | XP001211-30 | Panel, Side Spacer (AK1236S)        | 2 |
| <b>59</b> | XP164190-31 | Panel, Side Spacer (AK1236W)        | 2 |
| <b>60</b> | XP26602     | Panel Latch                         | 2 |

## Part Numbers - Breeze II



## Free Manuals Download Website

<http://myh66.com>

<http://usermanuals.us>

<http://www.somanuals.com>

<http://www.4manuals.cc>

<http://www.manual-lib.com>

<http://www.404manual.com>

<http://www.luxmanual.com>

<http://aubethermostatmanual.com>

Golf course search by state

<http://golfingnear.com>

Email search by domain

<http://emailbydomain.com>

Auto manuals search

<http://auto.somanuals.com>

TV manuals search

<http://tv.somanuals.com>