

Duct Cover Short, Long

Z1C-00HZ

Z1C-01HZ

For use with Horizon range hood

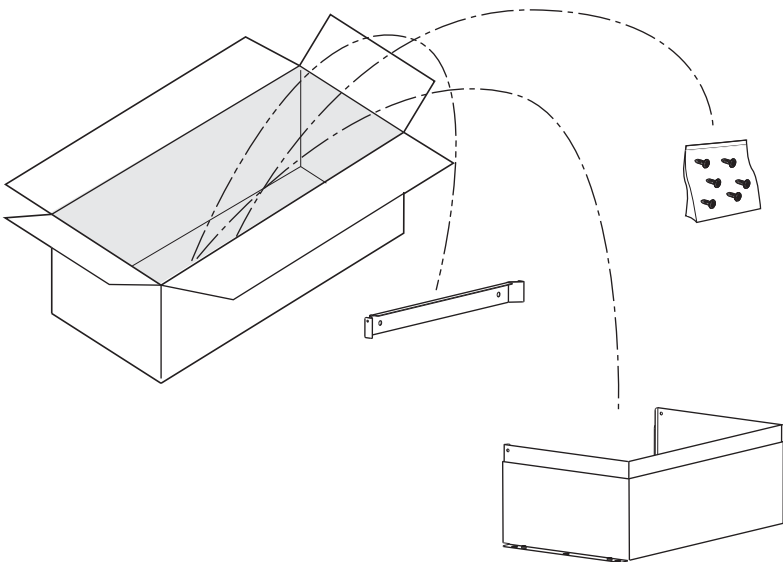

USA Mounting the duct cover **Pag. 3**

F Fixation des cheminées **Pag. 4**

E Fijación de las chimeneas **Pag. 5**

I Fissaggio dei camini **Pag. 6**

DUCT COVER EXTENSION SPECIFICATION

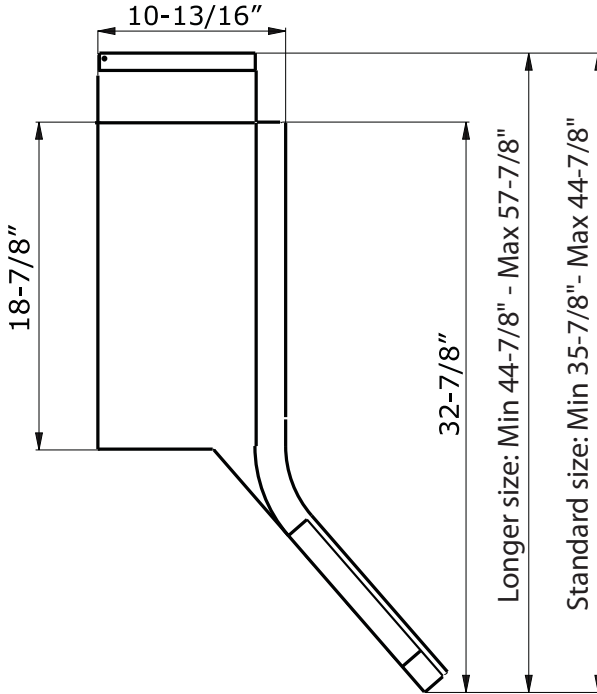

■ MOUNTING THE DUCT COVER

1. Unclip the top cover. Fig.1
2. Unscrew and remove the four clips on the hood Fig. 2
3. Position the chimneys on the hood as described in fig.3 and fasten the parts using the (4) screws provided.
4. Place correct size ducting for your installation (not supplied) to the hood and secure to the blower collar with aluminum duct tape. Fig. 4
5. Secure duct cover bracket to top of wall just below the ceiling observing the distance shown in Fig.5, and using (2) screws provided. See Fig.6
6. Extend top duct cover up and secure to the duct cover bracket using (2) screws. See Fig. 7

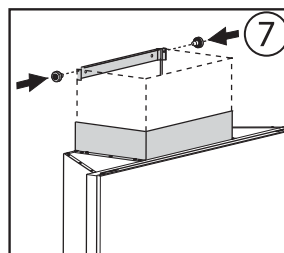
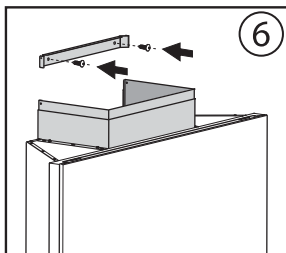
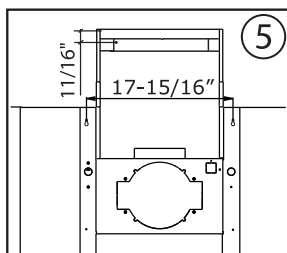
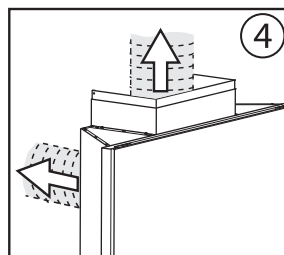
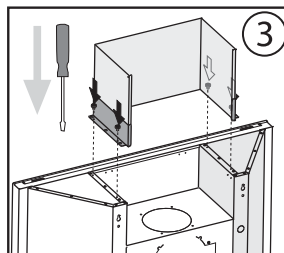
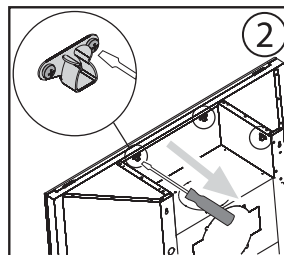
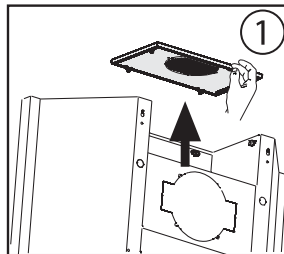

■ FIXATION DES CHEMINEES

1. Détacher le chapeau. Fig.1
2. Enlever les 4 accrochages sur la hotte en dévissant les vis. Fig. 2
3. Positionnez les cheminées dans le logement spécial sur la hotte., et les fixer avec les 4 vis. Fig. 3
4. Positionnez le conduit (non fourni) proportionné à l'installation sur la hotte et fixez-le au collier sur la bouche de la sortie d'air du moteur en utilisant le ruban aluminium spécial. Fig. 4
5. Fixez l'étrier à la paroi à peine sous le plafond en utilisant les (2) vis. Fig. 5 en respectant la distance indiquée en Fig. 6
6. Extraire le tube supérieur en le portant jusqu'à l'étrier et le fixer avec les (2) vis. Fig. 7

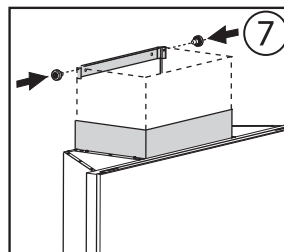
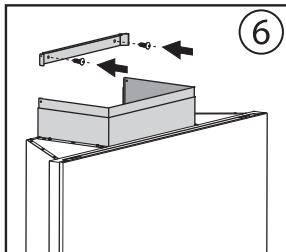
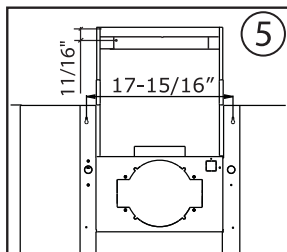
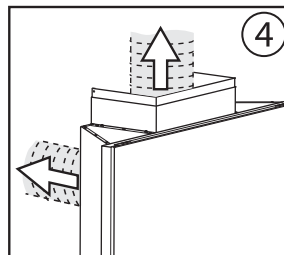
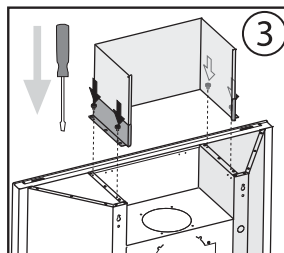
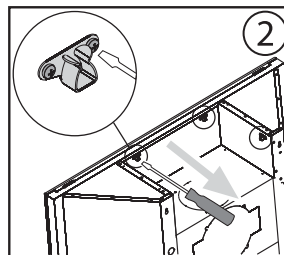
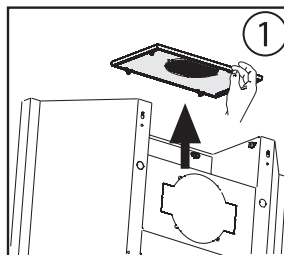

■ FIJACIÓN DE LAS CHIMENEAS

1. Desenganche la cúpula. Fig.1
2. Quitar los 4 enganches en la campana, desatornillando los tornillos. Fig. 2
3. Coloque las chimeneas en su lugar en la campana y fíjarlos con los (4) tornillos. Fig. 3
4. Coloque el conducto (no suministrado) de dimensiones adecuadas a la instalación, en la campana y fíjelo al collar arriba de l'abertura de la salida de l'aire del motor, mediante una cinta de aluminio. Fig. 4
5. Fije la abrazadera en la pared apenas debajo del techo, respetando la distancia indicada en la Fig.5, utilizando los (2) tornillos. Fig. 6
6. Extraiga el tubo superior llevándolo hasta la abrazadera y fíjelo con los (2) tornillos. Fig. 7

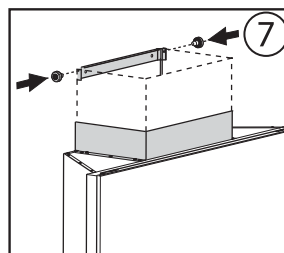
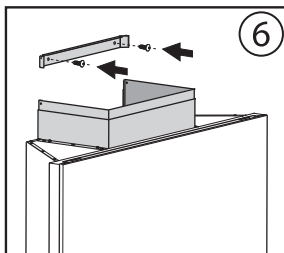
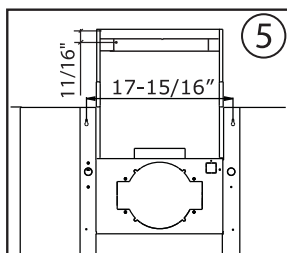
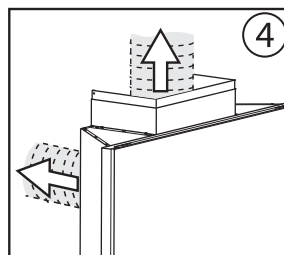
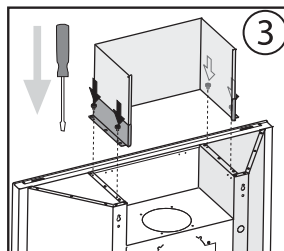
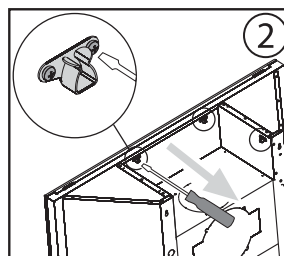
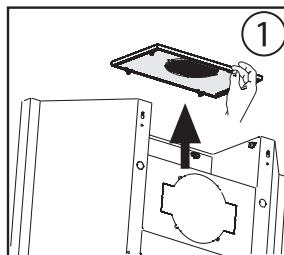



Installazione - Fissaggio Camini

■ FISSAGGIO DEI CAMINI

1. Sganciare il cupolino. Fig.1
2. Rimuovere i quattro agganci sulla cappa, svitando le viti. Fig. 2
3. Posizionare i camini nell'apposita sede sulla cappa, e fissarli con le (4) viti. Fig. 3
4. Posizionare il condotto (non in dotazione) con dimensioni adatte all'istallazione sulla cappa e fissarlo alla bocca uscita aria del motore mediante l'apposito nastro di alluminio. Fig. 4
5. Fissare la staffa sulla parete appena sotto il soffitto, rispettando la distanza indicata in Fig.5, utilizzando le (2) viti. Fig. 6
6. Estrarre il tubo superiore portandolo fino alla staffa e fissarlo con le (2) viti. Fig. 7

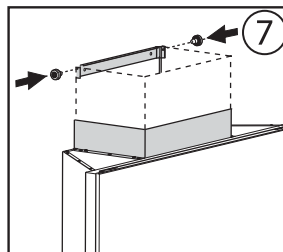
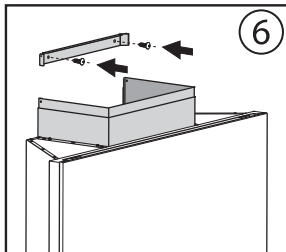
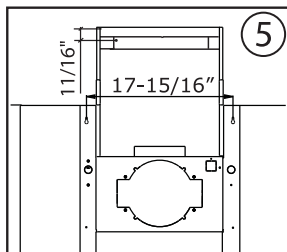
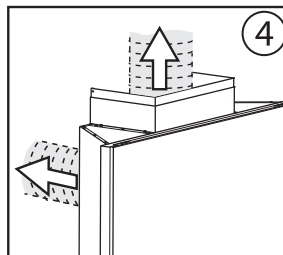
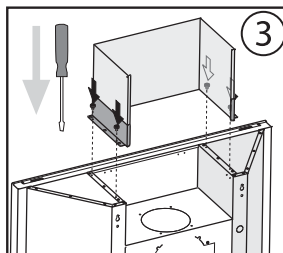
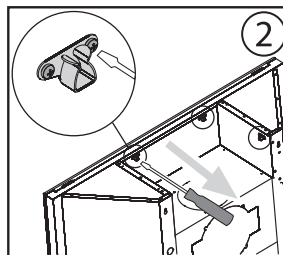
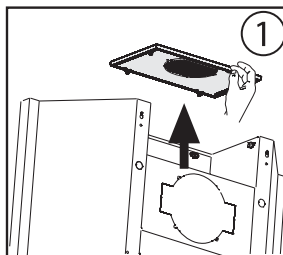



3FA0165

Free Manuals Download Website

<http://myh66.com>

<http://usermanuals.us>

<http://www.somanuals.com>

<http://www.4manuals.cc>

<http://www.manual-lib.com>

<http://www.404manual.com>

<http://www.luxmanual.com>

<http://aubethermostatmanual.com>

Golf course search by state

<http://golfingnear.com>

Email search by domain

<http://emailbydomain.com>

Auto manuals search

<http://auto.somanuals.com>

TV manuals search

<http://tv.somanuals.com>