

## Computer Specifications

### CPU and Memory

32-bit CPU	<p>4SX/25: Intel® i486SX, 25 MHz microprocessor; can be replaced with optional 487SX/25 or ODP486-25 OverDrive™ processor</p> <p>4DX/33: Intel i486DX, 33 MHz microprocessor; can be replaced with optional ODP486-33 OverDrive processor</p> <p>4DX2/50: Intel i486DX2, 50 MHz microprocessor</p>
System speed	<p>High and low speeds available; high speed depends on CPU (25 MHz, 33 MHz, or 50 MHz), low speed is simulated 8 MHz speed; speed selection through keyboard command; 0 wait state memory access at highspeed</p>

To select low speed, press the Ctrl, Alt, and - keys simultaneously. To select high speed, press the Ctrl, Alt, and + keys simultaneously. (Use the - or + key on the numeric keypad.)

Memory	<p>4MB RAM standard on a SIMM; expandable using 1MB, 4MB, or 16MB SIMMs to 32MB (maximum); SIMMs must be 36-bit, fast-page mode type with 70ns (or faster) access speed</p>
ROM	<p>128KB system BIOS, video BIOS, and SETUP code located in EPROM on main system board</p>
Video RAM	<p>512KB or 1MB DRAM on main system board; 512KB configuration expandable to 1MB</p>
Shadow RAM	<p>Supports shadowing of system and video BIOS ROM into RAM</p>
Cache	<p>8KB of internal cache (built into the microprocessor)</p>
Math coprocessor	<p>On 4DX/33 and 4DX2/50 systems, math coprocessor built into the microprocessor; optional 487 upgrade available for 4SX/25 system</p>
Clock/calendar	<p>Real-time clock, calendar, and CMOS RAM socketed on main system board with built-in battery backup</p>

### Controllers

Video	<p>Cirrus® VGA controller on main system board; provides resolutions up to 1024 x 768</p>
Diskette	<p>Controller on main system board supports up to two diskette drives or one diskette drive and one tape drive</p>
Hard disk	<p>Interface on main system board supports up to two IDE hard disk drives with built-in controllers</p>

### Interfaces

Monitor	<p>VGA interface built into main system board for analog or multifrequency VGA monitor; 15-pin, D-shell connector</p>
Parallel	<p>One standard 8-bit parallel, uni- or bi-directional interface built into main system board; I/O address selectable through SETUP; 25-pin, D-shell connector</p>
Serial	<p>Two RS-232C, programmable, asynchronous interfaces built into main system board; 9-pin, D-shell connectors</p>

## EPSON Endeavor 4SX/25, 4DX/33, and 4DX2/50

**Keyboard** PS/2 compatible keyboard interface built into main system board; num lock setting selectable through SETUP; 6-pin, mini DIN connector

**Mouse** PS/2 compatible mouse interface built into main system board; 6-pin, mini DIN connector

**Option slots** Four 16-bit (or 8-bit) I/O expansion slots, ISA compatible, 8 MHz bus speed; three slots accommodate any size card, bottom slot can hold reduced size card (4.4 inch/110 mm)

**Speaker** Internal

**Alternate VGA** IBM compatible VGA pass-through interface built into main system board; 26-pin connector

**Mass Storage** Three drives maximum (two horizontal mounts and one vertical mount), configurable using the following:

**Horizontal mounts** Up to two externally-accessible, half-height horizontal mounts; each horizontal bay can accommodate one **5¼-inch** form factor diskette, tape, CD-ROM, or other drive, or one **3½-inch** form factor hard disk, diskette, tape, CD-ROM, or other drive with **5¼-inch** mounting frames attached

**Vertical mount** One internal third- or half-height vertical mount; vertical bay can accommodate one **3½-inch** form factor hard disk or other drive

**Diskette drives** 5.25-inch, 1.2MB (high-density)  
3.5-inch, 1.44MB (high-density)  
5.25-inch, 360KB (double-density)  
3.5-inch, 720KB (double density)  
Combo 5.25-inch, 1.2MB/3.5-inch, 1.44MB (high density); combines two diskette drives in one

**Hard disk drives** **3½-inch** form factor hard disk drive(s), third- or half-height size; the first mounted vertically, second mounted horizontally

**Other devices** Half-height tape drive, CD-ROM drive, or other storage device; **5¼-inch** form factor or **3½-inch** form factor with **5¼-inch** mounting frames attached

**Keyboard** Detachable, two-position height; 101 or 102 sculpted keys; country-dependent main typewriter keyboard; numeric /cursor control keypad; four-key cursor control keypad; 12 function keys

**SETUP Program** Stored in ROM; accessible by pressing the Delete key at the SETUP prompt during boot

### Video Modes

Mode	Resolution	Colors	Memory required
VGA	640 x 480	16	512 KB
	640 x 480	256	512 KB
	640 x 480	32, 768*	1 MB
	640 x 480	65, 536*	1 MB
	640 x 480	16, 777, 216**	1 MB
	800 x 600	16	512 KB
	800 x 600	256	512 KB
	800 x 600	32, 768*	1 MB
	800 x 600	65, 536*	1 MB
	1024 x 768	16	512 KB
	1024 x 768	256	1 MB

\* Hi-Color \*\* TrueColor

### Power Supply

**Type** 145 Watt, fan cooled

**Input ranges** 98 to 132 VAC and 180 to 264 VAC, switch-selectable voltage

**Maximum outputs** +5 VDC at 18 Amps, +12 VDC at 4.0 Amps, -5 VDC at 0.3 Amps, -12 VDC at 0.3 Amps

**Frequency** 47 to 63 Hz

**Cables** Two to main system board; four to mass storage devices

### Option Slot Power Limits

Maximum current	+5 Volts	+12 Volts	-5 Volts and -12 Volts
For each slot	7 Amps	1.5 Amps	0.5 Amps
For all four slots	16 Amos	3 Amos	0.5 Amps

### Environmental Requirements

Condition	Operating range	Non-operating range	Storage range
Temperature	41° to 90° F (5° to 32° C)	-4° to 140° F (-20° to 60° C)	-4° to 140° F (-20° to 60° C)
Humidity (non-condensing)	20% to 90%	10% to 90%	10% to 90%
Altitude	-330 to 9,900 ft (-100 to 3,000 m)	-330 to 39,600 ft (-100 to 12,000 m)	-330 to 39,600 ft (-100 to 12,000 m)
Maximum wet bulb	68° F (20° C)	104° F (40° C)	134° F (57° C)
Acoustical noise	37.5 dB(A)	N/A	N/A

### Physical Characteristics

**Width** 14.8 inches (370 mm)

**Depth** 16.5 inches (412 mm)

**Height** 4.8 inches (120 mm)

**Weight** 16.7 lb (7.5 kg) with one diskette drive and one hard disk, without keyboard

Main System Board Diagram

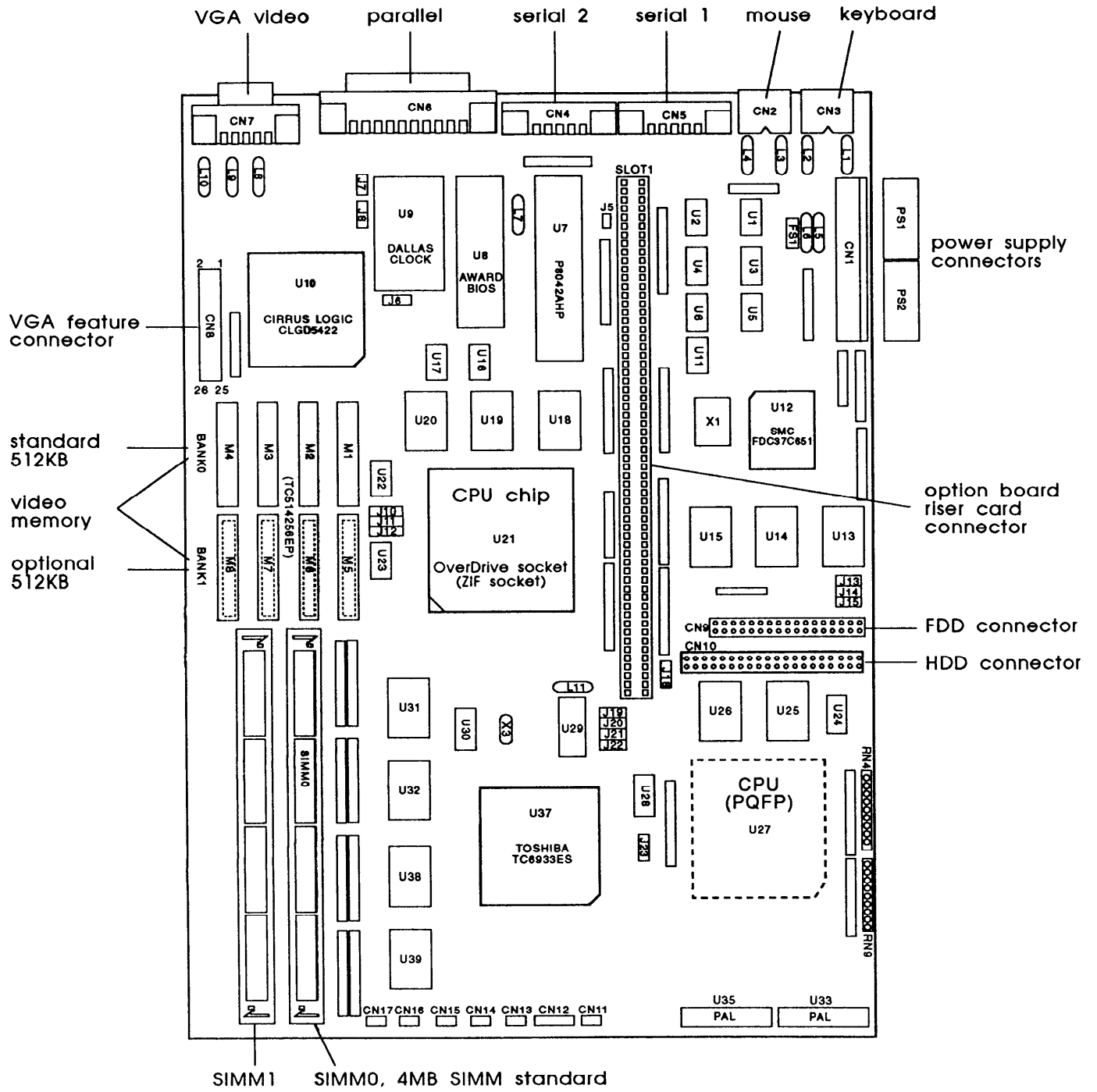

## Major Subassemblies

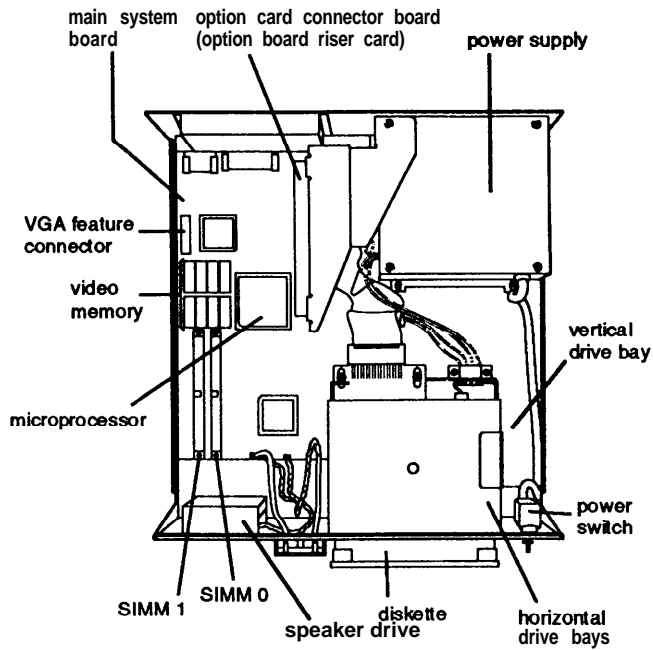

## Connector Pin Assignments

### Parallel Port Connector (CN6)

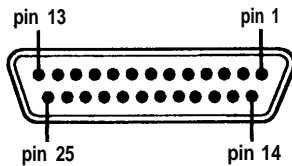

#### Parallel Port Connector Pin Assignments

Pin	Signal	Pin	Signal	Pin	Signal
1	Strobe	10	ACK*	19	Signal ground
2	Data 0	11	Busy	20	Signal ground
3	Data 1	12	PE	21	Signal ground
4	Data 2	13	Select	22	Signal ground
5	Data 3	14	Auto*	23	Signal ground
6	Data 4	15	Error*	24	Signal ground
7	Data 5	16	Init*	25	Signal ground
8	Data 6	17	Selectin*		
9	Data 7	18	Signal ground		

\*Active low logic

### Serial Port Connectors (CN4 and CN5)



#### Serial Port Connector Pin Assignments

Pin	Signal	Pin	Signal
1	Data carrier detect	6	Data set ready
2	Receive data	7	Request to send
3	Transmit data	8	Clear to send
4	Data terminal ready	9	Ring indicator
5	Not used		

### Keyboard Connector (CN3) and Mouse Connector (CN2)

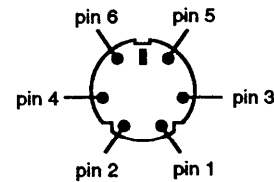

Although the keyboard and mouse connectors are physically identical, they cannot be used interchangeably.

#### Keyboard and Mouse Connector Pin Assignments

Pin	Signal	Pin	Signal
1	Data	4	+5 VDC (fused)
2	Reserved	5	Clock
3	Ground	6	Reserved

### VGA Port Connector (CN7)

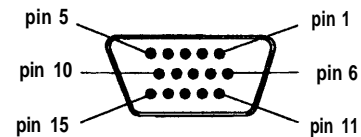

#### VGA Port Connector Pin Assignments

Pin	Signal	Pin	Signal	Pin	Signal
1	Red	6	Red ground	11	NC
2	Green	7	Green ground	12	NC
3	Blue	8	Blue ground	13	Horizontal sync
4	NC	9	NC	14	Vertical sync
5	Ground	10	Ground	15	NC

### VGA Feature Connector (CN8)

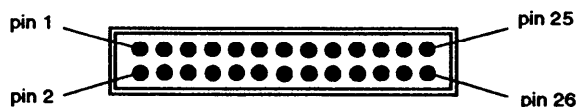

VGA Feature Connector Pin Assignments

Pin	Signal	Pin	Signal	Pin	Signal
1	Data 0	10	BLANK	19	ENPCLK*
2	Data 1	11	HSYNC	20	Not connected
3	Data 2	12	VSYNC	21	Ground
4	Data 3	13	Ground	22	Ground
5	Data 4	14	Ground	23	Ground
6	Data 5	15	Ground	24	Ground
7	Data 6	16	Ground	25	Not connected
8	Data 7	17	ENDATA*	26	Not connected
9	PCLK	18	ENSYNC*		

\*Active low logic

### DMA Assignments

Level	Assigned device
DMA0	Spare (&bit)
DMA1	Spare (&bit)
DMA2	FDD controller (&bit)
DMA3	Spare (8-bit)
DMA5	Spare (16-bit)
DMA6	Spare (16-bit)
DMA7	Spare (16-bit)

### Hardware Interrupts

IRQ no.	Function
IRQ0	Timer output
IRQ1	Keyboard
IRQ3	Serial port 2
IRQ4	Serial port 1
IRQ5	Available (parallel port 2)
IRQ6	FDD controller
IRQ7	Parallel port 1
IRQ8	Real-time clock
IRQ9	Available
IRQ10	Available
IRQ11	Available
IRQ12	PS/2 compatible mouse, optional pointing devices
IRQ13	Math coprocessor
IRQ14	HDD controller
IRQ15	Available

### System I/O Address Map

Hex address	Assigned device
000 - 01F	DMA controller 1, 8237A-5
020 - 03F	Interrupt controller 1, 8259A, master
040 - 05F	Timer, 8254-2
060 - 06F	8042 (Keyboard and mouse)
070 - 07F (CMOS)	Real-time clock NMI (non-maskable interrupt mask)
080 - 09F	DMA page register, 74LS612
0A0 - 0BF	Interrupt controller 2, 8259A
0C0 - 0DF	DMA controller 2, 8237A-5
0F0	Clear math coprocessor busy
0F1	Reset math coprocessor
0F8 - 0FF	Math coprocessor
1F0 - 1F8	Hard disk
200 - 207	Game I/O
278 - 27F	Parallel printer port 2
2B0 - 2DF	Alternate enhanced graphics adapter
2E1	GPIB (adapter 0)
2E2 and 2E3	Data acquisition (adapter 0)
2F8 - 2FF	Serial port 2
300 - 31F	Prototype card
348 - 357	DCA 3278
360 - 36F	PC network
378 - 37F	Parallel printer port 1
380 - 38F	SDLC, bisync 2
390 - 393	Cluster
3A0 - 3AF	Bisynchronous 1
3B0 - 3BF	Monochrome display and printer adapter
3C0 - 3CF	Enhanced graphics adapter
3D0 - 3DF	Color/graphics monitor adapter
3F0 - 3F7	FDD controller
3F8 - 3FF	Serial port 1
6E2 and 6E3	Data acquisition (adapter 1)
790 - 793	Cluster (adapter 1)
AE2 and AE3	Data acquisition (adapter 2)
B90 - B93	Cluster (adapter 2)
EE2 - EE3	Data acquisition (adapter 3)
1390 - 1393	Cluster (adapter 3)
22E1	GPIB (adapter 1)
2390 - 2393	Cluster (adapter 4)
42E1	GPIB (adapter 2)
62E1	GPIB (adapter 3)
82E1	GPIB (adapter 4)
A2E1	GPIB (adapter 5)
C2E1	GPIB (adapter 6)
E2E1	GPIB (adapter 7)

## Jumper Settings

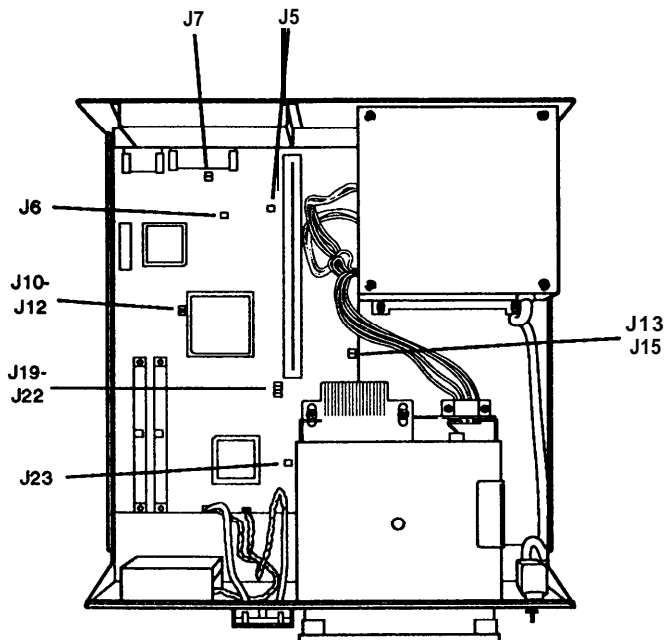

### Adapter, CMOS, and PQFP jumper Settings

Jumper number	Jumper setting	Function
J5***	On Off*	Supports CGA adapters Supports monochrome, EGA, MCGA, and VGA adapters
J6	1-2* 2-3	Enables the built-in VGA display adapter Disables the built-in VGA display adapter so you can use a display adapter on an option card in the computer as the primary adapter
J7***	On Off*	Returns CMOS RAM to the factory settings Retains SETUP program settings
J6	1-2* 2-3	Reserved
J18	1-2* 2-3	Gate A20 reset (standard setting for windows) Keyboard reset
J23**	1-2 2-3	Enables the WFP SX/25 processor Disables the PQFP SX/25 processor

\* Factory setting

\*\* Factory setting depends on type of processor on system board

. \*\* Two pin jumpers

### Processor Jumper Settings

Processor type	J10	J11	J12
486SX (in OverDrive socket)	2-3	2-3	Off
487SX (in OverDrive socket) or 486SX PQFP	1-2	1-2	2-3
486DX (in OverDrive socket)	1-2	1-2	1-2

You need to change the processor jumper settings if you install a new processor chip. The settings for J10, J11, and J12 must correspond to the type of chip installed.

If the computer's microprocessor is a FQFP type, it is surface-mounted on the main system board. To add an OverDrive processor, install it in the empty OverDrive socket and disable the original microprocessor by setting jumper J23 to position 2-3. Also make sure J10, J11, and J12 are set correctly.

### Processor Speed Jumper Settings

Processor type	J19	J20	J21	J22
SX/25, DX2/50 (25 MHz)	Off	Off	On	Off
DX/33, DX2/66 (33 MHz)	On	Off	Off	Off

You need to change the processor speed jumper settings if you replace a 25 MHz processor with a 33 MHz processor.

## Processor Chips

If you have the 4SX/25 or 4DX/33 system, you can install an Intel OverDrive processor on the main system board to effectively double the internal clock speed of the computer's microprocessor. Alternatively, for the 4SX/25, you can install the 487SX/25 microprocessor with built-in math coprocessor.

### OverDrive Processors

System	OverDrive processor
4SX/25	ODP486-25
40X/33	ODP486-33

## SIMM Installation

The computer comes with 4MB of memory installed in a SIMM socket. To increase the amount of memory in the computer up to 32MB, you can install 36-bit, fast-page mode SIMMs that operate at an access speed of 70ns or faster, with a capacity of 1MB, 4MB, or 16MB.

The following table shows the possible SIMM configurations; do not install memory in any other configuration. Make sure that both SIMMs operate at the same speed.

### SIMM Configurations

SIMM 0	SIMM 1	Total memory
4MB		4MB *
	4MB	4MB
4MB	1MB	5MB
1MB	4MB	5MB
4MB	4MB	8MB
16MB		16MB
	16MB	16MB
16MB	1MB	17MB
1MB	16MB	17MB
16MB	4MB	20MB
4MB	16MB	20MB
16MB	16MB	32MB

\* Standard memory

## Video Memory

If the computer has 512KB of video memory, you can install four 256K x 4 bit, 70ns, 20-pin DRAM DIP (Dual Inline Package) chips to increase the video memory to 1MB. The following table lists which DRAM DIP chips you can install on the main system board.

### Supported DRAM Chips

Manufacturer	Part number
Mitsubishi®	M5M44256BP-7
Toshiba®	TC514256AP-70
Micron®	MT4C4256-70

## Hard Disk Drive Types

The table below lists types of hard disk drives you can use in the computer. Check this table and your hard disk manual to find the correct type number(s) for the hard disk drive(s) installed in the computer. You need to enter the type number(s) when you set the hard disk drive configuration in the SETUP program.

### Hard Disk Drive Types

Type no.	Size* (in MB)	Cylinders (CYL)	Heads (HDS)	Sectors (SEC)	Precomp	Landing zone	Drive name/ manufacturer
1	10	306	4	17	128	305	
2	20	615	4	17	300	615	ST-225, ST-4026, WD-93024
3	30	615	6	17	300	615	ST-138A †
4	62	940	8	17	512	940	
5	46	940	6	17	512	940	
6	20	615	4	17	none	615	CP-3024, ST-125, ST-125A, ST-325A
7	30	462	8	17	256	511	
8	30	733	5	17	none	733	ST-4038
9	112	900	15	17	none	901	
10	20	820	3	17	none	820	
11	36	855	5	17	none	855	
12	49	855	7	17	none	855	
13	20	306	8	17	128	319	
14	42	733	7	17	none	733	
15							Reserved
16	20	612	4	17	0	663	
17	40	977	5	17	300	977	CDC 94205-51, CP-3044 †, CP-2044 †, 7040 †, 8051A †
18	56	977	7	17	none	977	
19	59	1024	7	17	512	1023	CP-2064
20	30	733	5	17	300	732	MK-133FA
21	42	733	7	17	300	732	MK-134FA, ST-157A †
22	30	733	5	17	300	733	
23	10	306	4	17	0	336	
24	81	903	4	46	none	902	CP-30084
25	100	776	8	33	none	775	CP-3104
26							Reserved
27	40	698	7	17	300	732	
28	40	976	5	17	488	977	
29							Reserved
30							Reserved
31	42	732	7	17	300	732	
32	42	1023	5	17	none	1023	

### Hard Disk Drive Types (continued)

Type no.	Size* (in MB)	Cylinders (CYL)	Heads (HDS)	Sectors (SEC)	Precomp	Landing zone	Drive name/ manufacturer
33	116	901	5	53	none	900	LPS120AT
34	234	723	13	51	none	722	LPS240AT †
35	124	934	16	17	none	933	MK2124FC
36							Reserved
37	202	683	16	38	none	682	CP-3204F
38	81	548	8	38	none	547	CP-2084
39	115	761	8	39	none	760	CP-30104 †
40	81	980	10	17	none	979	7080A, MK2024FC
41	84	1022	5	34	none	1022	CDC 94216-106 (ESDI)
42	89	1022	5	36	none	1022	CDC 94216-106
43	66	1024	8	17	512	1023	1325, 3085, LAN64, XT1085, NDR1085
44	137	828	10	34	none	828	MK-156F
45	42	1024	5	17	512	1023	
46	40	615	8	17	128	618	
47							Reserved
48							User defined
49							User defined

\* Actual size when formatted may be slightly different than the size listed on the drive label.

† Hard disk drive supported in translate mode

‡ Epson drives

If the computer has an Epson 120MB or 240MB hard disk drive, select the appropriate type number from the table below when you run the SETUP program.

### Epson Hard Disk Drive Types

Type number	Epson hard disk drive
39	120MB
34	240MB

## Installation/Support Tips

### Power

The computer has an input voltage selection switch on the back panel to select between 115V, for USA and Canadian use, and 230V, for use in other countries.

### Mouse and Keyboard

When connecting the mouse and keyboard to the computer, be careful to plug them into the proper ports. Although the ports are physically identical, they are not interchangeable, and damage may occur to the main system board if you plug the connectors into the wrong ports

### Installing Diskette Drives

Make sure that the drive type has been correctly selected in the SETUP program.

### Installing Hard Disk Drives

- ❑ It is recommended that a 16-bit, AT-type hard disk controller be used if you are installing a drive that cannot use the embedded IDE interface. If you install a non-IDE hard disk drive and controller card, you need to use the SETUP program to disable the built-in IDE hard disk drive interface.
- ❑ When installing a hard disk drive, see the hard disk drive type tables on page 7 and use the SETUP program to select the correct type number for the drive. You can select a type number that matches the parameters for the drive or a type number with parameters having lesser values, as long as they do not exceed the maximum capacity (in MB) of the drive. If there is no match for the drive, you can select a user-defined drive type (48 or 49) and enter the drive's exact parameters.

### Software Problems

- ❑ When installing a copy-protected software package, first try the installation at high speed. If this does not work properly, select low speed by pressing the Ctrl and Alt keys and the - key on the numeric keypad simultaneously. Try loading the program at low speed and then switching to high speed, if possible.
- ❑ When using a software package that uses a key disk as its copy-protection method, try loading it at high speed. If this does not work, load it at low speed.

### Password

Make sure that you do not forget the password you set up. If you do, you must disable it by setting jumper J7 on the main system board to the ON position.

If you set J7 to ON, however, CMOS RAM returns to the factory settings and you need to run the SETUP program to enter your system configuration again.

### Booting Sequence

If you cannot boot the computer from the hard disk drive, make sure the booting sequence in the SETUP program is set to A, C. Then boot the computer from a system diskette in drive A.

---

## Information Reference List

---

### Engineering Change Notices

None.

### Technical Information Bulletins

None.

### Product Support Bulletins

None.

### Related Documentation

TM-ENDVR	EPSON Endeavor Service Manual
PL-ENDVR	EPSON Endeavor Parts Price List
SPKENDVR	EPSON Endeavor Self Paced Kit
400195200	EPSON Endeavor Setup Guide
400195100	EPSON Endeavor User's Guide
400195000	EPSON VGA Utilities Guide



## Free Manuals Download Website

<http://myh66.com>

<http://usermanuals.us>

<http://www.somanuals.com>

<http://www.4manuals.cc>

<http://www.manual-lib.com>

<http://www.404manual.com>

<http://www.luxmanual.com>

<http://aubethermostatmanual.com>

Golf course search by state

<http://golfingnear.com>

Email search by domain

<http://emailbydomain.com>

Auto manuals search

<http://auto.somanuals.com>

TV manuals search

<http://tv.somanuals.com>