

Cisco CallManager Extended Services Administrator's Guide

Corporate Headquarters

Cisco Systems, Inc.
170 West Tasman Drive
San Jose, CA 95134-1706
USA
<http://www.cisco.com>
Tel: 408 526-4000
800 553-NETS (6387)
Fax: 408 526-4100

Customer Order Number: DOC-7812959=
Text Part Number: 78-12959-01

THE SPECIFICATIONS AND INFORMATION REGARDING THE PRODUCTS IN THIS MANUAL ARE SUBJECT TO CHANGE WITHOUT NOTICE. ALL STATEMENTS, INFORMATION, AND RECOMMENDATIONS IN THIS MANUAL ARE BELIEVED TO BE ACCURATE BUT ARE PRESENTED WITHOUT WARRANTY OF ANY KIND, EXPRESS OR IMPLIED. USERS MUST TAKE FULL RESPONSIBILITY FOR THEIR APPLICATION OF ANY PRODUCTS.

THE SOFTWARE LICENSE AND LIMITED WARRANTY FOR THE ACCOMPANYING PRODUCT ARE SET FORTH IN THE INFORMATION PACKET THAT SHIPPED WITH THE PRODUCT AND ARE INCORPORATED HEREIN BY THIS REFERENCE. IF YOU ARE UNABLE TO LOCATE THE SOFTWARE LICENSE OR LIMITED WARRANTY, CONTACT YOUR CISCO REPRESENTATIVE FOR A COPY.

The Cisco implementation of TCP header compression is an adaptation of a program developed by the University of California, Berkeley (UCB) as part of UCB's public domain version of the UNIX operating system. All rights reserved. Copyright © 1981, Regents of the University of California.

NOTWITHSTANDING ANY OTHER WARRANTY HEREIN, ALL DOCUMENT FILES AND SOFTWARE OF THESE SUPPLIERS ARE PROVIDED "AS IS" WITH ALL FAULTS. CISCO AND THE ABOVE-NAMED SUPPLIERS DISCLAIM ALL WARRANTIES, EXPRESSED OR IMPLIED, INCLUDING, WITHOUT LIMITATION, THOSE OF MERCHANTABILITY, FITNESS FOR A PARTICULAR PURPOSE AND NONINFRINGEMENT OR ARISING FROM A COURSE OF DEALING, USAGE, OR TRADE PRACTICE.

IN NO EVENT SHALL CISCO OR ITS SUPPLIERS BE LIABLE FOR ANY INDIRECT, SPECIAL, CONSEQUENTIAL, OR INCIDENTAL DAMAGES, INCLUDING, WITHOUT LIMITATION, LOST PROFITS OR LOSS OR DAMAGE TO DATA ARISING OUT OF THE USE OR INABILITY TO USE THIS MANUAL, EVEN IF CISCO OR ITS SUPPLIERS HAVE BEEN ADVISED OF THE POSSIBILITY OF SUCH DAMAGES.

AccessPath, AtmDirector, Browse with Me, CCIP, CCSI, CD-PAC, *CiscoLink*, the *Cisco Powered* Network logo, Cisco Systems Networking Academy, the Cisco Systems Networking Academy logo, Fast Step, Follow Me Browsing, FormShare, FrameShare, GigaStack, IGX, Internet Quotient, IP/VC, iQ Breakthrough, iQ Expertise, iQ FastTrack, the iQ Logo, iQ Net Readiness Scorecard, MGX, the Networkers logo, *Packet*, RateMUX, ScriptBuilder, ScriptShare, SlideCast, SMARTnet, TransPath, Unity, Voice LAN, Wavelength Router, and WebViewer are trademarks of Cisco Systems, Inc.; Changing the Way We Work, Live, Play, and Learn, Discover All That's Possible, and Empowering the Internet Generation, are service marks of Cisco Systems, Inc.; and Aironet, ASIST, BPX, Catalyst, CCDA, CCDP, CCIE, CCNA, CCNP, Cisco, the Cisco Certified Internetwork Expert logo, Cisco IOS, the Cisco IOS logo, Cisco Systems, Cisco Systems Capital, the Cisco Systems logo, Enterprise/Solver, EtherChannel, EtherSwitch, FastHub, FastSwitch, IOS, IP/TV, LightStream, MICA, Network Registrar, PIX, Post-Routing, Pre-Routing, Registrar, StrataView Plus, Stratm, SwitchProbe, TeleRouter, and VCO are registered trademarks of Cisco Systems, Inc. and/or its affiliates in the U.S. and certain other countries.

All other trademarks mentioned in this document or Web site are the property of their respective owners. The use of the word partner does not imply a partnership relationship between Cisco and any other company. (0106R)

Cisco CallManager Extended Services Administrator's Guide

Copyright © 2001, Cisco Systems, Inc.

All rights reserved.

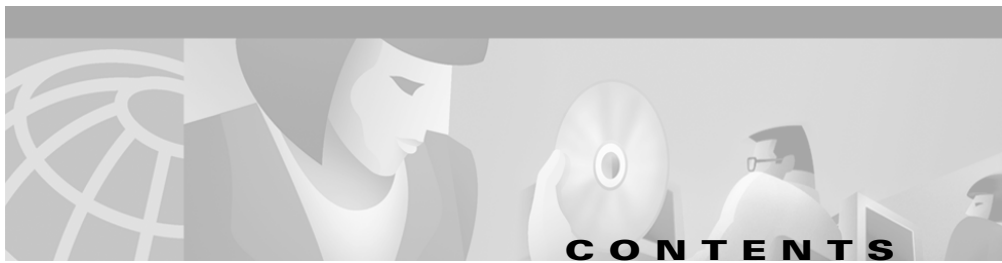

Preface ix

Audience **ix**

Organization **x**

Related Documentation **xi**

Conventions **xi**

Obtaining Documentation **xiii**

World Wide Web **xiii**

Documentation CD-ROM **xiii**

Ordering Documentation **xiv**

Documentation Feedback **xiv**

Obtaining Technical Assistance **xv**

Cisco.com **xv**

Technical Assistance Center **xv**

 Contacting TAC by Using the Cisco TAC Website **xvi**

 Contacting TAC by Telephone **xvi**

Understanding Cisco CallManager Extended Services 1-1

Cisco CallManager Extension Mobility Overview **1-2**

 Login Service **1-2**

 Logout Service **1-3**

Cisco CallManager AutoAttendant Overview **1-4**

Components of Cisco CallManager Extended Services **1-6**

Installing Cisco CallManager Extended Services 2-1

Before You Install **2-1**

Hardware Requirements **2-2**

Software Requirements **2-2**

Installing Cisco CallManager Extended Services **2-3**

Downloading and Installing Cisco CallManager Extended Services from the Internet **2-3**

Upgrading Cisco CallManager AutoAttendant or Re-installing Cisco CallManager Extended Services **2-6**

Configuring Cisco CallManager Extension Mobility 3-1

Rules for Configuring Cisco CallManager Extension Mobility **3-1**

Managing Device Profiles **3-2**

Autogenerated Device Profile **3-2**

User Device Profile **3-2**

Logging In and Logging Out **3-3**

Configuration Examples **3-3**

Scenario 1: All Users have Cisco CallManager Extension Mobility **3-3**

Scenario 2: Mixed Configuration **3-4**

Scenario 3: Mixed Configuration **3-4**

Configuration Rules **3-5**

Procedures for Configuring Cisco CallManager Extension Mobility **3-6**

Creating a New Application User **3-7**

Configuring the Cisco CRA Engine **3-10**

Adding the Login Application **3-10**

Adding the Logout Application **3-13**

Adding the Login Application Trigger **3-15**

Adding the Logout Application Trigger **3-17**

Configuring Cisco CallManager for Cisco CallManager Extension Mobility **3-19**

Adding the Login Service **3-19**

Adding the Logout Service **3-21**

Setting the Service Parameters **3-23**

Creating the Default Device Profile for a User **3-26**

Associating a User Device Profile to a User for Cisco CallManager
Extension Mobility **3-28**

Configuring the Cisco IP Phones for
Cisco CallManager Extension Mobility **3-30**

Setting up Anonymous Access on IBM-340 platforms **3-34**

Preparing the User for Cisco CallManager Extension Mobility **3-35**

Logging in to Cisco CallManager Extension Mobility **3-36**

Logging out of Cisco CallManager Extension Mobility **3-37**

Configuring Cisco CallManager AutoAttendant 4-1

Configuring Cisco CallManager for Cisco CallManager AutoAttendant **4-2**

Adding CTI Route Points in Cisco CallManager **4-2**

Adding CTI Ports in Cisco CallManager **4-3**

Creating a Cisco CallManager User for
Cisco CallManager AutoAttendant **4-4**

Configuring the Cisco CRA Engine for Cisco CallManager AutoAttendant **4-6**

Configuring Directory Information **4-6**

Configuring the JTAPI Subsystem on the Cisco Customer
Response Application Engine **4-9**

Adding a CTI Port Group **4-10**

Adding a New Cisco CallManager AutoAttendant **4-10**

Customizing Cisco CallManager AutoAttendant **4-12**

Configuring an Instance of Cisco CallManager AutoAttendant **4-12**

- Configuring Prompts **4-13**
 - General Media Configuration **4-13**
 - Recording the Welcome Prompt **4-14**
 - Configuring the Welcome Prompt **4-15**
 - Uploading a Spoken Name **4-16**
 - Uploading a Batch of Spoken Names **4-17**

Administering Cisco CallManager Extended Services 5-1

- Managing the Cisco CRA Engine **5-1**
 - Starting and Stopping the Cisco CRA Engine **5-2**
 - Changing Engine Configuration **5-3**
 - Setting Trace File Options **5-4**
 - Configuring the Trace File **5-4**
 - Setting Trace Level Options **5-5**
 - Viewing Trace Files **5-7**
- Using Cisco CRA Real-time Reporting **5-8**
 - Installing the Real-time Reporting Tool **5-8**
 - Applying the Real-time Reporting Tool **5-9**
 - Viewing Overall Application Engine Activity **5-9**
 - Monitoring Activity by Application **5-11**
 - Monitoring Activity by Task **5-12**
 - Resetting Statistics **5-12**
 - Printing Reports **5-13**
- Using Cisco CRA Historical Reporting **5-13**
 - Viewing IP IVR Historical Reports **5-14**
 - Enabling Historical Reporting **5-15**
 - Changing Historical Reporting Parameters **5-16**

Troubleshooting Cisco CallManager Extended Services 6-1

Clearing Problems with Cisco CallManager Extension Mobility **6-1**

Clearing General Problems **6-2**

Clearing Errors in Cisco CallManager Extension Mobility **6-2**

Unknown Error from Service **6-2**

Application Authentication Error **6-2**

Device Does Not Allow Logon **6-3**

Device Profile Does Not Exist **6-3**

Directory Service Error **6-3**

Proxy Not Allowed **6-3**

Another User Logged In **6-3**

No User Logged In **6-3**

Null Name for Device **6-3**

Login Server Connection Error **6-4**

System Not Enabled **6-4**

User Logged in Elsewhere **6-4**

HTTP Error **6-4**

Clearing Problems with Cisco CallManager AutoAttendant **6-5**

No Matches for an Existing User **6-5**

Cisco CallManager AutoAttendant Prompt is Not Found **6-5**

INDEX

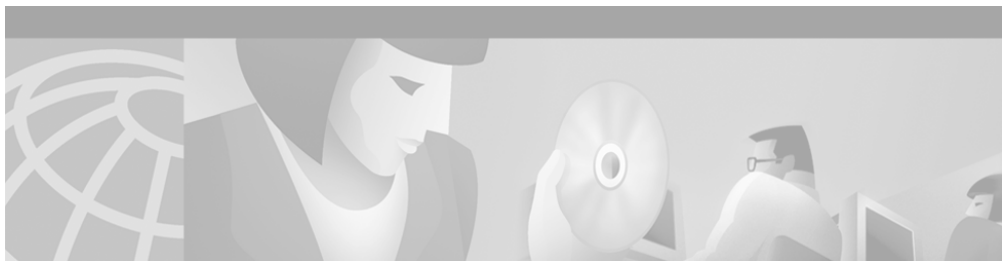

Preface

The Cisco CallManager Extended Services Administrator's Guide provides instructions for installing, configuring and administering Cisco CallManager Extended Services. This document will help you to:

- Understand Cisco CallManager Extended Services and how its applications work.
- Perform product installation.
- Perform initial configuration.
- Perform ongoing administration tasks.
- Troubleshoot problems with the applications.

Audience

The *Cisco CallManager Extended Services Administrator's Guide* is written for a server administrator or network administrator who is responsible for implementing Cisco CallManager Extended Services. No programming skills are required.

Organization

This guide is organized as follows:

Chapter	Title	Description
Chapter 1	Understanding Cisco CallManager Extended Services	A general overview of Cisco CallManager Extended Services and the IP Telephony software suite.
Chapter 2	Installing Cisco CallManager Extended Services	Sequenced procedures for the initial installation of Cisco CallManager Extended Services.
Chapter 3	Configuring Cisco CallManager Extension Mobility	Sequenced procedures for the initial configuration of Cisco CallManager Extension Mobility.
Chapter 4	Configuring Cisco CallManager AutoAttendant	Sequenced procedures for the initial configuration of Cisco CallManager AutoAttendant.
Chapter 5	Administering Cisco CallManager Extended Services	Procedures for managing Cisco CallManager Extended Services on an ongoing basis.
Chapter 6	Troubleshooting Cisco CallManager Extended Services	Procedures for troubleshooting Cisco CallManager Extended Services and clearing error messages.

Related Documentation

For information about Cisco CallManager, refer to the following documents:

- *Cisco CallManager System Guide*
- *Cisco CallManager Administration Guide*

For information about Cisco Customer Response Applications, refer to the following documents:

- *Getting Started with Cisco Customer Response Applications*
- *Cisco Customer Response Applications Administrator's Guide*
- *Cisco Customer Response Applications Developer's Guide*
- *Cisco Customer Response Applications Troubleshooting Guide*

Conventions

This document uses the following conventions:

Convention	Description
boldface font	Commands and keywords are in boldface .
<i>italic font</i>	Arguments for which you supply values are in <i>italics</i> .
[]	Elements in square brackets are optional.
{ x y z }	Alternative keywords are grouped in braces and separated by vertical bars.
[x y z]	Optional alternative keywords are grouped in brackets and separated by vertical bars.
string	A nonquoted set of characters. Do not use quotation marks around the string or the string will include the quotation marks.
screen font	Terminal sessions and information the system displays are in <code>screen font</code> .
boldface screen font	Information you must enter is in boldface screen font .

Convention	Description
<i>italic screen font</i>	Arguments for which you supply values are in <i>italic screen font</i> .
^	The symbol ^ represents the key labeled Control—for example, the key combination ^D in a screen display means hold down the Control key while you press the D key.
< >	Nonprinting characters, such as passwords are in angle brackets.

Notes use the following conventions:



Note

Means *reader take note*. Notes contain helpful suggestions or references to material not covered in the publication.

Timesavers use the following conventions:



Timesaver

Means *the described action saves time*. You can save time by performing the action described in the paragraph.

Tips use the following conventions:



Tips

Means *the following are useful tips*.

Cautions use the following conventions:



Caution

Means *reader be careful*. In this situation, you might do something that could result in equipment damage or loss of data.

Warnings use the following conventions:



Warning

This warning symbol means danger. You are in a situation that could cause bodily injury. Before you work on any equipment, you must be aware of the hazards involved with electrical circuitry and familiar with standard practices for preventing accidents.

Obtaining Documentation

The following sections provide sources for obtaining documentation from Cisco Systems.

World Wide Web

You can access the most current Cisco Systems documentation on the World Wide Web at the following sites:

- <http://www.cisco.com>
- <http://www-china.cisco.com>
- <http://www-europe.cisco.com>

Documentation CD-ROM

Cisco documentation and additional literature are available in a CD-ROM package, which ships with your product. The Documentation CD-ROM is updated monthly and may be more current than printed documentation. The CD-ROM package is available as a single unit or as an annual subscription.

Ordering Documentation

Cisco Systems documentation is available in the following ways:

- Registered Cisco Direct Customers can order Cisco Product documentation from the Networking Products MarketPlace:
http://www.cisco.com/cgi-bin/order/order_root.pl
- Registered Cisco.com users can order the Documentation CD-ROM through the online Subscription Store:
<http://www.cisco.com/go/subscription>
- Nonregistered CCO users can order documentation through a local account representative by calling Cisco corporate headquarters (California, USA) at 408 526-7208 or, in North America, by calling 800 553-NETS(6387).

Documentation Feedback

If you are reading Cisco product documentation on the World Wide Web, you can submit technical comments electronically. Click **Feedback** in the toolbar and select **Documentation**. After you complete the form, click **Submit** to send it to Cisco.

You can e-mail your comments to bug-doc@cisco.com.

To submit your comments by mail, for your convenience many documents contain a response card behind the front cover. Otherwise, you can mail your comments to the following address:

Cisco Systems, Inc.
Document Resource Connection
170 West Tasman Drive
San Jose, CA 95134-9883

We appreciate your comments.

Obtaining Technical Assistance

Cisco provides Cisco.com as a starting point for all technical assistance. Customers and partners can obtain documentation, troubleshooting tips, and sample configurations from online tools. For Cisco.com registered users, additional troubleshooting tools are available from the TAC website.

Cisco.com

Cisco.com is the foundation of a suite of interactive, networked services that provides immediate, open access to Cisco information and resources at anytime, from anywhere in the world. This highly integrated Internet application is a powerful, easy-to-use tool for doing business with Cisco.

Cisco.com provides a broad range of features and services to help customers and partners streamline business processes and improve productivity. Through Cisco.com, you can find information about Cisco and our networking solutions, services, and programs. In addition, you can resolve technical issues with online technical support, download and test software packages, and order Cisco learning materials and merchandise. Valuable online skill assessment, training, and certification programs are also available.

Customers and partners can self-register on Cisco.com to obtain additional personalized information and services. Registered users can order products, check on the status of an order, access technical support, and view benefits specific to their relationships with Cisco.

To access Cisco.com, go to the following website:

<http://www.cisco.com>

Technical Assistance Center

The Cisco Technical Assistance Center (TAC) website is available to all customers who need technical assistance with a Cisco product or technology that is under warranty or covered by a maintenance contract.

Contacting TAC by Using the Cisco TAC Website

If you have a priority level 3 (P3) or priority level 4 (P4) problem, contact TAC by going to the TAC website:

<http://www.cisco.com/tac>

P3 and P4 level problems are defined as follows:

- P3—Your network performance is degraded. Network functionality is noticeably impaired, but most business operations continue.
- P4—You need information or assistance on Cisco product capabilities, product installation, or basic product configuration.

In each of the above cases, use the Cisco TAC website to quickly find answers to your questions.

To register for Cisco.com, go to the following website:

<http://www.cisco.com/register/>

If you cannot resolve your technical issue by using the TAC online resources, Cisco.com registered users can open a case online by using the TAC Case Open tool at the following website:

<http://www.cisco.com/tac/caseopen>

Contacting TAC by Telephone

If you have a priority level 1 (P1) or priority level 2 (P2) problem, contact TAC by telephone and immediately open a case. To obtain a directory of toll-free numbers for your country, go to the following website:

<http://www.cisco.com/warp/public/687/Directory/DirTAC.shtml>

P1 and P2 level problems are defined as follows:

- P1—Your production network is down, causing a critical impact to business operations if service is not restored quickly. No workaround is available.
- P2—Your production network is severely degraded, affecting significant aspects of your business operations. No workaround is available.



Understanding Cisco CallManager Extended Services

Cisco CallManager Extended Services bring valuable IP telephony capabilities to a Cisco CallManager deployment. These new extended services significantly differentiate Cisco's IP Telephony solution from features provided with traditional PBX systems.

Cisco CallManager Extended Services consist of two features: Cisco CallManager Extension Mobility and Cisco CallManager AutoAttendant.

Use this document if you are running Cisco CallManager Extended Services with Cisco CallManager pre-3.3(2) and Cisco Customer Response Application (Cisco CRA) 2.2 and later.



Note

With Cisco CallManager 3.3(2) and later, the Cisco CallManager Extension Mobility application and the Cisco CallManager Extension Mobility service in Cisco CallManager provide the extension mobility functionality. The feature no longer requires the Cisco CRA engine. If you are using Extension Mobility and AutoAttendant with Cisco CallManager 3.3(2) and later, see the *Cisco CallManager Features and Services Guide* at the following URL:
http://www.cisco.com/univercd/cc/td/doc/product/voice/c_callmg/index.htm

This section provides an introduction to Cisco CallManager Extended Services:

- [Cisco CallManager Extension Mobility Overview, page 1-2](#)
- [Cisco CallManager AutoAttendant Overview, page 1-4](#)
- [Components of Cisco CallManager Extended Services, page 1-6](#)

Cisco CallManager Extension Mobility Overview

The Cisco CallManager Extension Mobility feature allows users within a Cisco CallManager cluster to configure any Cisco IP Phone 7960/7940 as their own, temporarily, by logging in to that phone. Once logged in, the phone adopts the user's personal phone number(s), speed dials, services links and other user-specific properties. After logout, the phone adopts the original user profile.

With Cisco CallManager Extension Mobility, several employees can share office space on a rotational basis instead of having a designated office. This approach is commonly used in work environments such as sales offices and consulting firms where employees do not routinely conduct business in the same place or keep the same hours every day.

Login Service

Administrators can program the login service, an XML-based authentication service, for a variety of uses, including duration limits on phone configuration and login authorization for particular phones. Programming is done in Cisco CallManager Service Parameters Configuration.

The user interface to the login service is accessed through the Services button on Cisco IP Phone Models 7960 or 7940. The user enters login information in the form of a UserID and a Personal Identification Number (PIN). The Login Application receives the XML-over-HTTP request and verifies the information against the Cisco IP Telephony Directory (see [Figure 1-1](#)). The phone is reconfigured automatically with the individual user device profile information.

Logout Service

The user logs out by pressing the Services button and selecting logout. After the user logs out, Cisco CallManager sends the original user profile to the phone and restarts the phone.

Figure 1-1 Cisco CallManager Extension Mobility Architecture

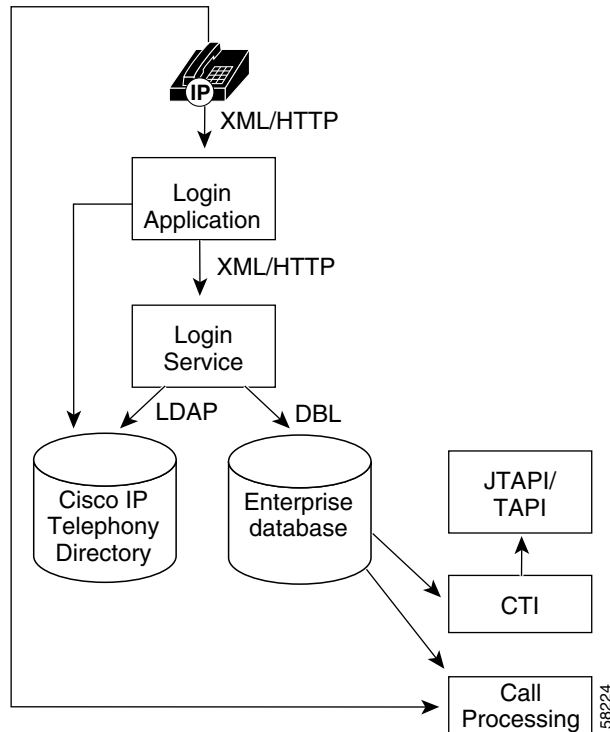

Cisco CallManager AutoAttendant Overview

The Cisco CallManager AutoAttendant (Cisco CallManager AA), illustrated in [Figure 1-2](#), works with Cisco CallManager to receive calls on specific telephone extensions and to allow callers to select appropriate extensions.

Figure 1-2 Using Cisco CallManager AA

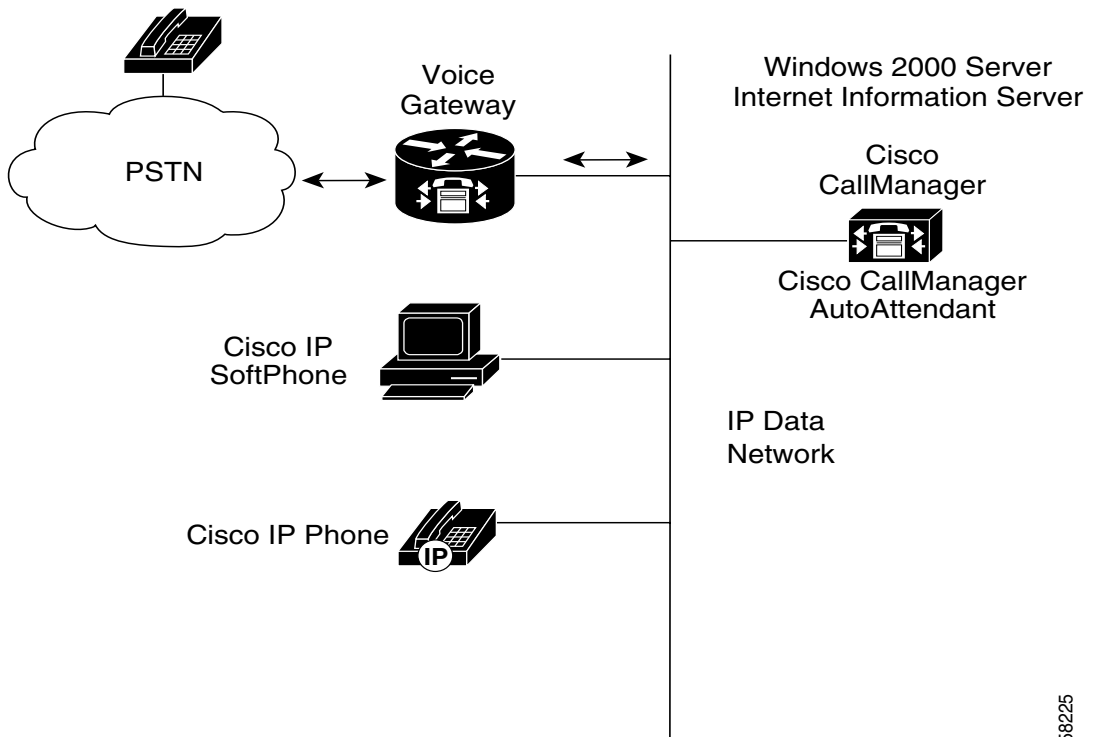

58225

The Cisco CallManager AA provides the following functionality:

- Answers a call
- Plays a user-configurable Welcome prompt
- Plays a Main Menu prompt, asking the user to perform one of three actions:
 - Press “0” for the operator
 - Press “1” to enter an extension number
 - Press “2” to spell by name
- If the caller chooses to spell by name (option 2), the system compares the letters entered with the names configured to the available extensions.
 - If one matches, the system prompts the user for confirmation of the name, and transfers the call to that user’s primary extension.
 - If there is more than one match, the system prompts the user to select the correct extension.
 - If there are too many matches, the system prompts the user to enter more characters.
- When the caller has specified the destination, the system transfers the call.
 - If the line is busy or not in service the system informs the user accordingly and replays the Main Menu prompt.

Components of Cisco CallManager Extended Services

The Cisco Customer Response (CR) Platform provides the components required to run Cisco CallManager Extended Services. The Cisco CR platform provides a multimedia (voice/data/Web) IP-enabled customer care application environment. The Cisco CR Platform uses Voice over IP (VoIP) technology, so your telephony network can share resources with your data network.

Cisco CallManager Extended Services uses four main components of the Cisco Customer Response Platform:

- **Gateway**—Connects the enterprise IP telephony network to the Public Switched Telephone Network (PSTN) and to other private telephone systems such as Public Branch Exchange (PBX).
- **Cisco CallManager Server**—Provides the features required to implement IP phones, manage gateways, provides failover and redundancy service for the telephony system, and directs Voice over IP (VoIP) traffic to the Cisco Customer Response Application (Cisco CRA) system.
- **Cisco IP Telephony Directory**—Stores configuration information and Cisco CRA application scripts in a LDAP directory. The subdirectory that stores Cisco CRA scripts is called the repository. Storing application scripts and configuration information in an LDAP directory allows you to load application scripts on any Cisco CRA engine in the network. The repository keeps one backup version of each script for recovery purposes. You can revert to the previous version if necessary.
- **Cisco CRA Server**—Contains the Cisco CRA Engine that runs Cisco CRA applications. Cisco CRA applications comprise a series of steps, implemented as Java Beans packaged in .jar files.

Figure 1-3 shows how Cisco CRA integrates with your Cisco IP telephony solution.

Figure 1-3 shows Cisco CallManager and Cisco CRA systems running on separate servers. You can install Cisco CallManager Extended Services co-resident on the same server as Cisco CallManager or on a separate server.

Figure 1-3 Cisco IP Telephony Solution Components

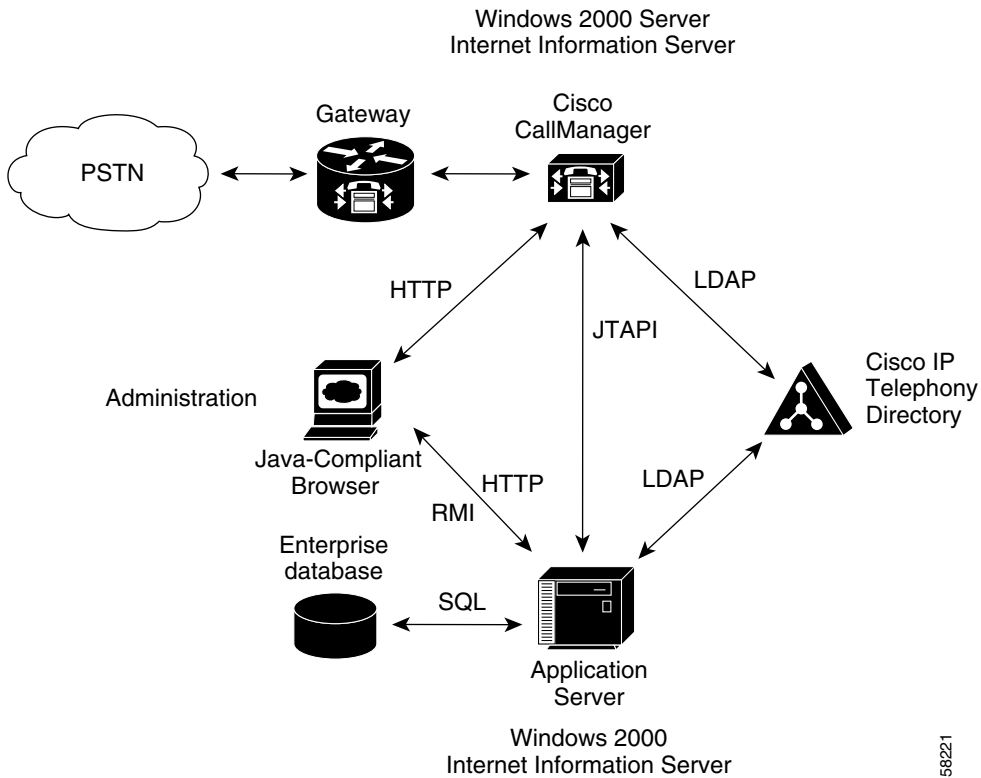

For more information about the Cisco CR Platform, refer to the *Cisco Customer Response Applications Administrator's Guide*.



Installing Cisco CallManager Extended Services

This section describes how to install Cisco CallManager Extended Services on a Cisco Media Convergence Server (Cisco MCS) or on a Cisco certified server:

1. [Before You Install, page 2-1](#)
2. [Installing Cisco CallManager Extended Services, page 2-3](#)

Before You Install

Before you begin the installation of Cisco CallManager Extended Services, ensure that you have met hardware and software requirements and configured Windows 2000 components. Check the [“Hardware Requirements” section on page 2-2](#) and the [“Software Requirements” section on page 2-2](#) before you proceed.

Hardware Requirements

Cisco CallManager Extended Services run on the Cisco Media Convergence Server (Cisco MCS) platform or a customer-provided Cisco-certified server such as the Compaq DL320 and DL380 and the IBM-330 and IBM-340.

Cisco recommends that you can install Cisco CallManager Extended Services co-resident on the same server as Cisco CallManager.

Hardware requirements for a co-resident server configuration of Cisco CallManager Extended Services are:

- The installation of Cisco CallManager Extended Services requires 275MB.
- Running Cisco CallManager Extended Services requires 512MB for the Cisco MCS 7820 series (7820, 7822, and 7825) and 1GB for the Cisco MCS 7930 series (7930 and 7935).

Software Requirements

Cisco CallManager Extended Services requires the following software components to operate:

- Cisco CallManager 3.1
- Microsoft Windows 2000

Installing Cisco CallManager Extended Services

Install Cisco CallManager 3.1 and Windows 2000 before you install Cisco CallManager Extended Services.

**Note**

If you do not have Cisco CallManager 3.1 installed first, Cisco CallManager Extended Services will abort during its installation.

**Note**

You must configure proxy settings for Internet Explorer and verify that you can browse to the internal and external web site. For details on configuring your proxy settings, contact your network administrator.

Downloading and Installing Cisco CallManager Extended Services from the Internet

To install Cisco CallManager Extended Services, perform the following steps:

Procedure

- Step 1** Start up the Cisco MCS or Cisco certified server and log into Windows 2000.
- Step 2** Use a web browser to access the following URL:
<http://www.cisco.com/cgi-bin/tablebuild.pl/callmgr-31>
Click the **CallManager Upgrades** link.
- Step 3** Locate Cisco CallManager Extended Services and download the file: `cm-es.ffr.2-2-1.exe`.
- Step 4** Double-click on the downloaded file to launch the installer.
- Step 5** Click **Next** at the Welcome to the Cisco CallManager Extended Services Installation Wizard window.

Step 6 A window appears with a checklist of applications offered by Cisco CallManager Extended Services. See [Figure 2-1](#).

Check the box next to the applications you wish to install:

- CallManager Cisco AA
- Cisco Extension Mobility

Step 7 Click the **Next** button.

Figure 2-1 *Installing Cisco CallManager Extended Services*

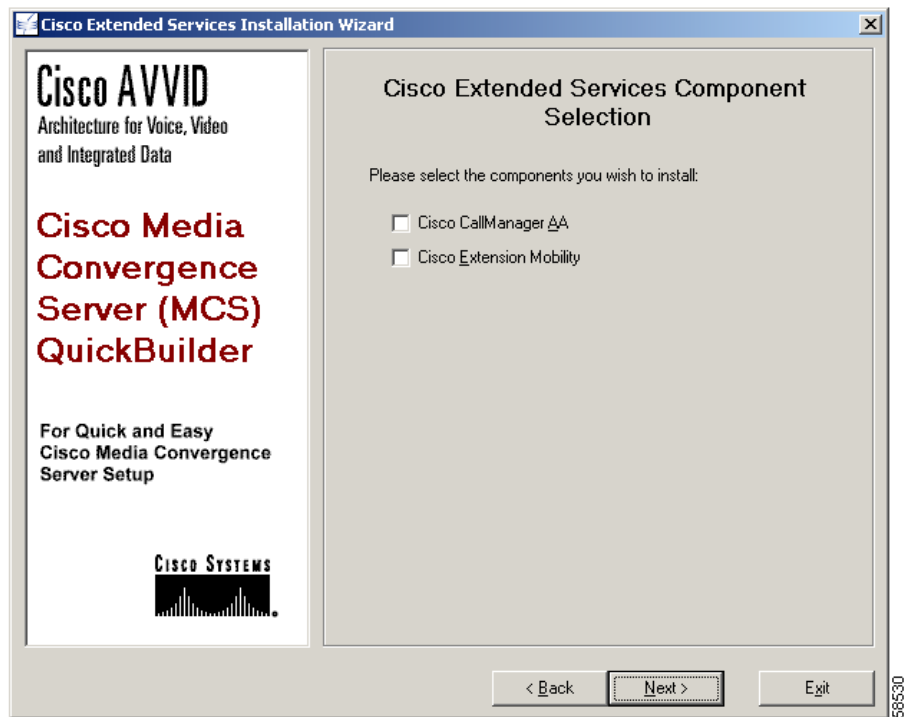

Step 8 If you are installing a Cisco CallManager application for the first time, skip to [Step 11](#).

If you are performing a reinstall or upgrade, the system asks you to confirm that you want to reinstall.

Step 9 Click **Yes**.

- Step 10** At this point, the installation checks for the presence of Cisco CallManager 3.1. If Cisco CallManager Release 3.1 is not present, you are prompted to upgrade to Cisco CallManager Release 3.1. The installation of Cisco CallManager Extended Services will not continue until Cisco CallManager Release 3.1 is present.
- Step 11** Confirm your installation selection by clicking **Yes**.
The system displays a message asking where the Cisco CallManager Database is located.
- Step 12** To install Cisco CallManager Extension Mobility on the same server as Cisco CallManager, select **This Server**.
To install Cisco CallManager Extension Mobility on a different server from Cisco CallManager, select **A Different Server** and enter the server's hostname, and a username and password.
- Step 13** Click **Next**.
- Step 14** At the CiscoWorks2000 Syslog Configuration screen you can elect to configure the CiscoWorks2000 Syslog collector.
If you have a CiscoWorks2000 server on your network, you can click the **Configure CiscoWorks2000 Syslog Collector** check box to install the CiscoWorks Syslog Collector module on this computer. If you click this check box, enter the location of your CiscoWorks2000 server.
If you do not have a CiscoWorks 2000 server on your network, do not click the Configure CiscoWorks 2000 Syslog Collector check box.
- Step 15** At the Ready to Install Cisco CallManager Extended Services window, click **Next**.
The system takes approximately 10 minutes to install Cisco CallManager Extended Services.
- Step 16** The installation blanks the administrator password. Re-enter the password as shown here:
- a. Enter the new password to be used for the MCS or Cisco certified server. Click **Okay**.
 - b. Enter the new password to be used for the SQL Server. Click **Okay**.
- Step 17** To reboot, click **Yes** when prompted.
-

Upgrading Cisco CallManager AutoAttendant or Re-installing Cisco CallManager Extended Services

To upgrade to Cisco CallManager Extended Services from an earlier version of Cisco CallManager AutoAttendant, or to re-install the current version of Cisco CallManager Extended Services, perform the following steps:

Procedure

- Step 1** On the Cisco CallManager server, choose **Start > Programs > Cisco CRA Administrator > Application Administrator**. Enter your user name and password and click **OK**. The Application Administration Setup page appears.
- Step 2** Click **Setup** on the Application Administration Setup page. The Directory Configuration page appears. The necessary fields are pre-populated with your directory configuration data.
- Step 3** Click **OK** to confirm the directory configuration.
- Step 4** Launch a command window by choosing **Start > Run**.
- Step 5** Enter “cmd” and click **OK**.
- Step 6** Set the directory to C:\Program Files\wfvavid.
- Step 7** If you are upgrading from Cisco CallManager AutoAttendant Release 2.0, run: “UpgradeAA.bat.”



Note You do not need to reboot after this procedure.



Configuring Cisco CallManager Extension Mobility

The following topics describe how to configure Cisco CallManager Extension Mobility:

- [Rules for Configuring Cisco CallManager Extension Mobility, page 3-1.](#)
- [Procedures for Configuring Cisco CallManager Extension Mobility, page 3-6](#)

This chapter also includes information for you to give Cisco CallManager Extension Mobility users. See the “[Preparing the User for Cisco CallManager Extension Mobility](#)” section on page 3-35.

Rules for Configuring Cisco CallManager Extension Mobility

It is important to understand how device profiles work with Cisco CallManager Extension Mobility in order to configure the service correctly.

This section discusses the following topics:

- [Managing Device Profiles, page 3-2](#)
- [Logging In and Logging Out, page 3-3](#)
- [Configuration Examples, page 3-3](#)
- [Configuration Rules, page 3-5](#)

Managing Device Profiles

A device profile is made up of a set of attributes (services and/or features) associated with a particular device. Device profiles include name, description, phone template, add-on modules, directory numbers, subscribed services, and speed dial information.

You can think of the device profile as a device which is not yet physically embodied. It has all the properties of a device except those which are explicitly tied to a device, like MAC address or directory URL, for example.

When a device profile has been loaded onto a device, that device adopts the attributes of that device profile. A device can adopt a device profile when there is no user logged in (that is, when a device is first initialized and when a user logs out) or when a user logs in.

There are two types of device profiles: autogenerated device profiles and user device profiles.

Autogenerated Device Profile

An autogenerated device profile generates when you update the phone settings and choose a current setting to generate an autogenerated device profile. An autogenerated device profile represents a snapshot of an existing device's configuration.

The autogenerated device profile associates with a specific phone to be the logout device profile. That is, when a logout command for a device is received, this is the profile loaded onto a device.

An autogenerated device profile cannot be associated with a user. An autogenerated device profile can only be loaded onto a device when there is no user logged in. You can modify the autogenerated device profile, but not delete it.

User Device Profile

You can assign a user device profile to a user so that when a user logs in or out of a device, the corresponding user device profile is loaded onto that device. Devices can adopt user device profiles when a user logs into a device or when there is no user logged in. You can modify, or delete a user device profile in the Cisco CallManager administration pages.

Logging In and Logging Out

When a user logs in, the current configuration of a device is replaced by a particular user device profile.

When a user logs out, the current configuration of a device (the user default device profile) is replaced by the logout profile.

Cisco CallManager Extension Mobility supports only one login at a time on a device. Subsequent logins will fail.

You cannot log out of a device which does not have anyone logged in.

Configuration Examples

This section describes different scenarios using Cisco CallManager Extension Mobility:

- [Scenario 1: All Users have Cisco CallManager Extension Mobility, page 3-3](#)
- [Scenario 2: Mixed Configuration, page 3-4](#)
- [Scenario 3: Mixed Configuration, page 3-4](#)

Scenario 1: All Users have Cisco CallManager Extension Mobility

In a typical Cisco CallManager Extension Mobility scenario, all employees are users of Cisco CallManager Extension Mobility. The users are configured to have a default device profile and they do not control their individual phones. They must log into a phone before they can use it as their extension.

Employees have access to common devices, such as lobby phones, conference room phones, and cubicle phones that are meant to be shared.

When users go to the Cisco Phone User Options web pages to change their services or speed dials, they can select only their default device profiles from the “Select a device to configure” drop-down menu. Any changes users make to their services follows them to any phone they log into.



Note

In this scenario, users cannot modify settings for an individual phone.

This is a recommended configuration.

Scenario 2: Mixed Configuration

In this configuration, each user has a phone assigned to him. Each user has a device profile too which follows him on every device he logs into. Each user has access to common devices, such as lobby phones, conference room phones, and cubicle phones that are meant to be shared.

**Note**

In this scenario, no one is allowed to use anyone else's phone.

This is a recommended configuration.

Scenario 3: Mixed Configuration

In this scenario, some employees may have a regular desk phone and other users can log into this phone.

This is **not** a recommended configuration for Cisco CallManager Extension Mobility for the following reasons.

When a device is configured for Cisco CallManager Extension Mobility, a snapshot of that device is taken which is used as a profile after a user logs off that device.

With Cisco CallManager Extension Mobility enabled on Tom's personal extension, Tom goes to his Cisco Phone User Options web pages to configure services. He has two options from the "Select device to configure" drop-down menu: the device (the office phone) he controls or the Default Device Profile.

- If Tom selects his office phone and it is a device which a user controls, Tom can add services such as speed dials or Cisco stock price display. If Dick logs into that phone, Dick's default device profile is loaded onto that phone. When Dick logs off, the snapshot profile, without the speed dials and Cisco stock price display, is loaded on the phone.
- If Tom selects his Default Device Profile from the "Select device to configure" down-down menu, the changes that he makes to this profile will appear only on the phone on which he logs into immediately after making the change and **not** on the device he controls.

Configuration Rules

To avoid problems deploying Cisco CallManager Extension Mobility, be sure to follow these configuration rules:

- If you want to enable all phones within your Cisco CallManager cluster for Cisco CallManager Extension Mobility, you must not allow the users to control these devices. That is, when a user goes to the Cisco IP Phone User Options web page to change his services, he can only select “Default Device Profile” from the “Select a device to configure” drop-down list. He cannot modify the settings for an individual phone.
- If there is a device which a particular user controls, for example, his office phone, you must not allow anyone else to log into that device.



Note

The administrator can change the services for a phone in the Cisco CallManager Administration page. After making the changes, if he updates on the main page (not the pop up menu) the administrator is prompted to reset the phone for the changes to take affect. Then, the new snapshot is stored as the logout profile.



Note

It is recommended that each user of Cisco CallManager Extension Mobility log into his phone at the beginning of the work day. This ensures that his default device profile is loaded on his phone. He can make changes to this profile and it will follow him where he logs in.

Procedures for Configuring Cisco CallManager Extension Mobility

Perform the following procedures to configure Cisco CallManager Extension Mobility.

**Caution**

For successful configuration of Cisco CallManager Extension Mobility, perform all the procedures in the order shown and follow all steps thoroughly.

1. [Creating a New Application User, page 3-7](#)
2. [Configuring the Cisco CRA Engine, page 3-10](#)
 - a. [Adding the Login Application, page 3-10](#)
 - b. [Adding the Logout Application, page 3-13](#)
 - c. [Adding the Login Application Trigger, page 3-15](#)
 - d. [Adding the Logout Application Trigger, page 3-17](#)
3. [Configuring Cisco CallManager for Cisco CallManager Extension Mobility, page 3-19](#)
 - a. [Adding the Login Service, page 3-19](#)
 - b. [Adding the Logout Service, page 3-21](#)
 - c. [Setting the Service Parameters, page 3-23](#)
 - d. [Creating the Default Device Profile for a User, page 3-26](#)
 - e. [Associating a User Device Profile to a User for Cisco CallManager Extension Mobility, page 3-28](#)
 - f. [Configuring the Cisco IP Phones for Cisco CallManager Extension Mobility, page 3-30](#)
4. [Setting up Anonymous Access on IBM-340 platforms, page 3-34](#)

This section also includes information to give Cisco CallManager Extension Mobility users. See the “[Preparing the User for Cisco CallManager Extension Mobility](#)” section on page 3-35.

Creating a New Application User

To create a new application user for Cisco CallManager Extension Mobility, perform the following steps:

Procedure

- Step 1** On the Cisco CallManager server, choose **Start > Programs > Cisco CallManager 3.1 > CallManager Administration**. You can also connect to the Cisco CallManager server by using the following URL:
- `http://servername/ccmAdmin`
- where *servername* is the DNS name or IP address of your Cisco CallManager server.
- You will be prompted to enter the network password.
- Step 2** Choose **User > Add a New User**.
- Step 3** At the Add a New User screen, enter the first name (for example, extension), last name (for example, mobility), and UserID (for example, emapplication).
- Step 4** At the User Password and Confirm Password fields, enter a password of your choice.
- Step 5** At the PIN field, enter a numeric Personal Identification Number (PIN) of your choice. Confirm the PIN number.
- Step 6** To save your changes and add the user, click **Insert**.

- Step 7** In the User Information page, select **Extension Mobility** from the left pane (see [Figure 3-1](#)).

Figure 3-1 Adding Cisco CallManager Extension Mobility for the User

The screenshot shows the Cisco CallManager Administration interface. At the top, there is a navigation menu with links for System, Route Plan, Service, Feature, Device, User, Application, and Help. Below the menu is a header with the Cisco CallManager Administration logo and the Cisco Systems logo. The main content area is titled "User Information" and includes links for "Personal Information" and "Back to user list". On the left, there is a sidebar titled "extension's Application Profiles" with a tree view containing "Device Association", "Auto Attendant", "Extension Mobility", and "SoftPhone". The "Extension Mobility" option is selected. The main content area displays the "User : extension mobility" configuration page. It includes a status message: "Status: Please enter any changes for the current user." Below this are two buttons: "Update" and "Cancel Changes". The form contains several fields: "First Name*" with the value "extension", "Last Name*" with the value "mobility", "UserID" with the value "emapplication", "User Password*" with "****", "Confirm Password*" with "****", "PIN*" with "****", "Confirm PIN*" with "****", "Telephone Number", and "Manager".

A new User Information page displays.

58551

- Step 8** Scroll down the User Information page. At the Enable Authentication Proxy Rights check box, click **Enabled** (see [Figure 3-2](#)).
- Step 9** Click **Update**.

Figure 3-2 Enabling Authentication Proxy Rights

System Route Plan Service Feature Device User Application Help

Cisco CallManager Administration
For Cisco IP Telephony Solutions

CISCO SYSTEMS

User Information

[Personal Information](#)
[Back to user list](#)

Assign Profiles For : emapplication (mobility, extension)

Status: Please enter any changes for the current user.

Available Profile List Filters

Find profiles where:

User Device Profile Profile Name begins with

Select Profiles

No Filter Active
0 available device profile(s) listed at last search.
0 device profile(s) controlled at last search.
0 device profile(s) selected currently.

Update Cancel Changes

Enable Authentication Proxy Rights

58417

Related Topics:

- [Configuring Cisco CallManager Extension Mobility, page 3-1](#)
- [Configuring the Cisco CRA Engine, page 3-10](#)

Configuring the Cisco CRA Engine

To configure the Cisco Customer Response Application (CRA) Engine for Cisco CallManager Extension Mobility, perform the following procedures:

1. [Adding the Login Application, page 3-10](#)
2. [Adding the Logout Application, page 3-13](#)
3. [Adding the Login Application Trigger, page 3-15](#)
4. [Adding the Logout Application Trigger, page 3-17](#)

Adding the Login Application

To add the Login Application for Cisco CallManager Extension Mobility, perform the following steps:

Procedure

- Step 1** Connect to the application server by using the following URL:
- `http://servername/AppAdmin`
- where *servername* is the DNS name or IP address of your Cisco Customer Response Application Engine (Cisco CRA Engine).
- Step 2** Click **Generic Applications**.
- The Application page displays.
- Step 3** On the Application page, click **Add new application**.
- Step 4** In the Application Name field, enter any name for the application (for example, Login).
- Step 5** At the Cisco Script Application Configuration page, use the drop-down arrow and select the **hotel.aef** script. The system populates the script name with hotel.aef, as shown in [Figure 3-3](#).

Figure 3-3 Selecting the Login Application

Application Administration [Help](#)

Cisco Script Application Configuration

Application Name*

Script Name*

or select from the following helper list :

▼

*indicates required item.

58234

- Step 6** Click **Next**.
- Step 7** In the Application ID field, enter a unique Application Identifier between 1 and 50.
- Step 8** In the Maximum Number of Sessions field, enter the number of concurrent HTTP sessions between 1 and 50.
- Step 9** At the Enabled field, enter **Yes**.
- Step 10** Enter the following parameters: the user name and password of the user you created in the [“Creating a New Application User”](#) section on page 3-7. See [Figure 3-4](#).
- Step 11** Click **Update**.

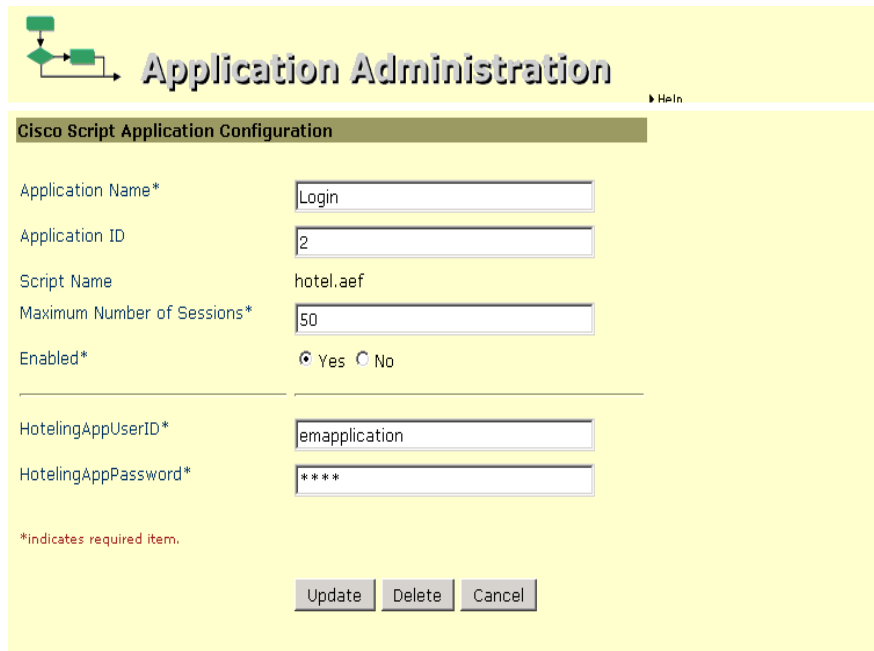
Figure 3-4 Adding the Login Application

The screenshot displays the 'Application Administration' interface. At the top left is a small flowchart icon. The main title is 'Application Administration' with a 'Help' link to its right. Below this is a section titled 'Cisco Script Application Configuration'. The configuration fields are as follows:

Application Name*	Login
Application ID	2
Script Name	hotel.aef
Maximum Number of Sessions*	50
Enabled*	<input checked="" type="radio"/> Yes <input type="radio"/> No
<hr/>	
HotelingAppUserID*	emapplication
HotelingAppPassword*	****

*indicates required item.

Update Delete Cancel

58652

Related Topics:

- [Creating a New Application User, page 3-7](#)
- [Adding the Logout Application, page 3-13](#)

Adding the Logout Application

To add the Logout Application for Cisco CallManger Extension Mobility, perform the following steps:

Procedure

- Step 1** On the Application Administration page, click **Generic Applications**. This takes you to the Application page.
- Step 2** On the Application page, click the **Add new application** link.
- Step 3** In the Application Name field, enter any name for the application (for example, Logout).
- Step 4** At the Cisco Script Application Configuration page, use the drop-down arrow and select the **hotelOut.aef** script. The system populates the script name with hotelOut.aef (see [Figure 3-5](#)).

Figure 3-5 *Selecting the Logout Application*



The screenshot shows the 'Application Administration' page with a navigation diagram in the top left. The main heading is 'Application Administration' with a 'Help' link. Below this is a section titled 'Cisco Script Application Configuration'. The form contains the following fields and controls:

- Application Name***: A text input field containing 'Logout'.
- Script Name***: A text input field containing 'hotelOut.aef'.
- Below the Script Name field, the text 'or select from the following helper list :' is displayed.
- A dropdown menu below the text, currently showing 'hotelOut.aef'.
- A red asterisk note: '*indicates required item.'
- At the bottom, there are two buttons: 'Next' and 'Cancel'.

58563

- Step 5** Click **Next**.

- Step 6** In the Application ID field, enter a unique Application Identifier between 1 and 50.
- Step 7** In the Maximum Number of Sessions field, enter the number of concurrent HTTP sessions between 1 and 50.
- Step 8** At the Enabled field, enter **Yes**.
- Step 9** Enter the following parameters: the user name and password of the user you created in [Creating a New Application User, page 3-7](#). (See [Figure 3-6](#).)
- Step 10** Click **Update**.

Figure 3-6 Adding the Logout Application

Application Administration

Cisco Script Application Configuration

Application Name*

Application ID

Script Name

Maximum Number of Sessions*

Enabled* Yes No

strAppID*

HotelingAppPassword*

*indicates required item.

56967

Related Topics:

- [Adding the Login Application, page 3-10](#)
- [Adding the Login Application Trigger, page 3-15](#)

Adding the Login Application Trigger

To add the Extension Mobility Login Application Trigger, perform the following steps:

Procedure

Step 1 On the Application Administration page, click the **HTTP Triggers** link.

Step 2 Click **Add new HTTP Trigger**.

Step 3 At the Trigger Name field, enter a trigger (for example, /login).

**Tips**

Be sure to start your Trigger Name with a backward slash: “/”.

Step 4 Select the application you created in the “[Adding the Login Service](#)” section on [page 3-19](#) (for example, Login).

Step 5 In the Maximum Number of Sessions field, enter the number of concurrent HTTP sessions between 1 and 50.

Step 6 At the Enabled field, click **Yes** (see [Figure 3-7](#)).

Figure 3-7 Adding the Login Application Trigger

Application Administration ▶ Help

HTTP Trigger Configuration

Trigger Name*

Application Name*

Maximum Number of Sessions*

Enabled* Yes No

*indicates required item.

56236

Step 7 Click **Update**.

Step 8 Click **Return to Main Menu**.

Related Topics:

- [Adding the Logout Application, page 3-13](#)
- [Adding the Logout Application Trigger, page 3-17](#)

Adding the Logout Application Trigger

You add the Extension Mobility Logout Application Trigger the same way you added the Login Application Trigger. Perform the following steps:

Procedure

Step 1 On the Application Administration page, click the **HTTP Triggers** link.

Step 2 Click **Add new HTTP Trigger**.

Step 3 At the Trigger Name field, enter a trigger (for example, /logout).



Tips

Be sure to start your Trigger name with a backward slash: “/”.

Step 4 Select the application you created in the “[Adding the Logout Service](#)” section on [page 3-21](#) (for example, Logout).

See [Figure 3-8](#) on [page 3-17](#).

Figure 3-8 Adding the Logout Application Trigger

The screenshot shows the 'Application Administration' page with a 'HTTP Trigger Configuration' form. The form includes the following fields and options:

- Trigger Name***: /logout
- Application Name***: Logout (selected from a dropdown menu)
- Maximum Number of Sessions***: 50
- Enabled***: Yes No

A note at the bottom left of the form states: *indicates required item.

Buttons at the bottom of the form are: Update, Delete, and Cancel.

58638

- Step 5** In the Maximum Number of Sessions field, enter the number of concurrent HTTP sessions between 1 and 50.
- Step 6** At the Enabled field, enter **Yes**.
- Step 7** Click **Update**.
- Step 8** Click **Return to Main Menu**.
-

Related Topics:

- [Adding the Login Application Trigger, page 3-15](#)
- [Configuring Cisco CallManager for Cisco CallManager Extension Mobility, page 3-19](#)

Configuring Cisco CallManager for Cisco CallManager Extension Mobility

To configure Cisco CallManager for Extension Mobility, perform the following procedures:

1. [Adding the Login Service, page 3-19](#)
2. [Adding the Logout Service, page 3-21](#)
3. [Setting the Service Parameters, page 3-23](#)
4. [Creating the Default Device Profile for a User, page 3-26](#)
5. [Associating a User Device Profile to a User for Cisco CallManager Extension Mobility, page 3-28](#)
6. [Configuring the Cisco IP Phones for Cisco CallManager Extension Mobility, page 3-30](#)

Adding the Login Service

To add the Login Service for Cisco CallManager Extension Mobility, perform the following steps:

Procedure

- Step 1** On the Cisco CallManager server, choose **Start > Programs > Cisco CallManager 3.1 > Administration**.
- Step 2** Select **Feature**.
- Step 3** Use the drop-down arrow to select **Cisco IP Phone Services**.
- Step 4** At the Service Name field, enter a name for the service which will identify it for the user (for example, Login).

- Step 5** At the Service URL field, enter the IP address of the application engine and the HTTP trigger you created in Step 3 of the “Adding the Login Application” section on page 3-10 (for example, http://AppServerIP: 8080/login).

**Caution**

The URL is case-sensitive. Make sure you enter the exact name you entered for the Login Application Trigger.

**Tips**

Always use port 8080.

See [Figure 3-9](#).

Figure 3-9 Adding the Login Service

The screenshot shows the Cisco CallManager Administration interface. The main heading is "Cisco IP Phone Services Configuration". On the left is a sidebar with a tree view of services: Agent Status, Conference, Epage service, Epage2, Epage3, IAQ Agent Service, JustATest, Login, Login International, LoginNew, Logout, Logout International, and LogoutNew. The "Login" service is selected. The main content area shows "Service: New" with "Status: Ready" and "Insert" and "Cancel Changes" buttons. Below that is the "Service Information" section with the following fields:

Service Name*	Service Description
Login	Extension Mobility Login

Below the table is the "Service URL*" field with the value "http://AppServerIP:8080/login".

- Step 6** Click **Insert** and click **Update**.

Related Topics:

- [Adding the Login Application Trigger, page 3-15](#)
- [Adding the Logout Service, page 3-21](#)
- [Setting the Service Parameters, page 3-23](#)

Adding the Logout Service

To add the Logout Service for Cisco CallManager Extension Mobility, perform the following steps:

Procedure

-
- Step 1** On the Cisco CallManager 3.1 > Administration page, select **Feature**.
- Step 2** Use the drop-down arrow to select **Cisco IP Phone Services**.
- Step 3** At the Service Name field, enter a name for the service which will identify it for the user (for example, Logout).
- Step 4** At the Service URL field, enter the IP address of the application engine and the HTTP trigger you created in Step 3 of [Adding the Logout Application, page 3-13](#) (for example, http://AppServerIP: 8080/logout).

**Caution**

The URL is case-sensitive. Make sure you enter the exact name you entered for the Logout Application Trigger.

**Tips**

Always use port 8080.

See [Figure 3-10](#).

Figure 3-10 Adding the Logout Service



Step 5 Click **Insert** and click **Update**.

Related Topics:

- [Adding the Login Service, page 3-19](#)
- [Setting the Service Parameters, page 3-23](#)

Setting the Service Parameters

Setting the Service Parameters in the CallManager Service Parameters Configuration page allows you to define the maximum login time and the multi login behavior for Cisco CallManager Extension Mobility.

Maximum Login Time

At the Enforce Maximum Login Time, set True or False. True indicates you wish to define a maximum login time.

At the Maximum Login Time field, enter the maximum login time. This is a system-wide maximum time specified for logins. After this time, the system automatically logs out the device.

**Note**

The automatic logout service is used for all logins if a system maximum login time is specified. Each login will then have an automatic logout set up for the maximum duration.

Multi Login Behavior

At the Multi Login Behavior field, select one of the following options:

- **Multiple Logins Allowed:** A user can log into more than one device at a time.
- **Multiple Logins Not Allowed:** The second and subsequent login attempts after a user logs in once successfully will fail.
- **Auto Logout:** When a user logs into a second device, they are automatically logged out of the first device.
- The default value is Multiple Logins Not Allowed.

To set the Service Parameters for Cisco CallManager Extension Mobility, perform the following steps:

Procedure

- Step 1** On the Cisco CallManager 3.1 > Administration page, select **Service > Service Parameters**.
- The Service Parameters Configuration page displays
- Step 2** From the pull-down menu, select the server address of your Cisco CallManager. A new Service Parameters Configuration page displays.
- Step 3** From the Services list box on the left side of the page, choose Cisco Extension Mobility (see [Figure 3-11](#)).

Figure 3-11 Selecting the Logout Service

The screenshot displays the Cisco CallManager Administration interface. At the top, there is a navigation menu with options: System, Route Plan, Service, Feature, Device, User, Application, and Help. Below this is the Cisco CallManager Administration header with the tagline 'For Cisco IP Telephony Solutions' and the Cisco Systems logo. The main content area is titled 'Service Parameters Configuration' and includes a link to 'Select Another Server'. On the left, a 'Services' list box contains the following items: Cisco CTIManager, Cisco CallManager, Cisco Database Layer Monitor, Cisco Extension Mobility, Cisco IP Voice Media Streaming App, Cisco MOH Audio Translator, Cisco Messaging Interface, Cisco RIS Data Collector, Cisco TFTP, and Cisco Telephony Call Dispatcher. To the right of the list, the 'Current Server' is 172.21.12.66 and the 'Current Service' is 'New' with a status of 'Ready'. Below this, there is an 'Insert' button and a dropdown menu for 'Service*' currently showing '--- Not Selected ---'. A note at the bottom states '* indicates required item'. The page number 58554 is visible in the bottom right corner.

A new Service Parameters Configuration page displays.

Figure 3-12 shows the Service Parameters screen, with the service parameter information entered.

Figure 3-12 Setting the Service Parameters

System Route Plan Service Feature Device User Application Help

Cisco CallManager Administration
For Cisco IP Telephony Solutions

CISCO SYSTEMS

Service Parameters Configuration

[Select Another Server](#)
[Select Another Service](#)

Current Server : 172.21.12.66

Current Service: Cisco Extension Mobility 

Status: Ready

Parameter Name	Parameter Value	Suggested Value
Login Service Enabled*	True	True
Enforce Maximum Login Time*	False	False
Maximum Login Time (Hours:Minutes)*	8:00	8:00
Multi Login Behavior*	Multiple Logins Not Allowed	Multiple Logins Not Allowed

* indicates required item
 [Click here for More Information.](#)

583418

- Step 4** At the Login Service Enabled field, select **True** to enable the user login service. The default value is True. Selecting false disables the user login service.
- Step 5** At the Enforce Maximum Login Time, set **True** or **False**. If you select True, the service logs a user out of a device automatically after a maximum login time. The default value is False.
- Step 6** At the Maximum Login Time field, enter the maximum login time (Hours:Minutes) from 1 to 168:00 (one minute to one week). The default value is 8:00 (8 hours).

- Step 7** At the Multi Login Behavior field, select one of the following responses:
- **Multiple Logins Allowed:** A user can log into more than one device at a time.
 - **Multiple Logins Not Allowed:** The second and subsequent login attempts after a user successfully logs in once will fail.
 - **Auto Logout:** After a user logs into a second device, he is automatically logged out of the first device.
The default value is Multiple Logins Not Allowed.
- Step 8** Click **Update**.
-

Related Topics:

- [Adding the Login Service, page 3-19](#)
- [Adding the Logout Service, page 3-21](#)
- [Creating the Default Device Profile for a User, page 3-26](#)

Creating the Default Device Profile for a User

The Default Device Profile contains attributes such as name, description, phone template, add-on modules, directory numbers, subscribed services, and speed dial information.

**Note**

Before proceeding, you must have a device profile name and phone button template(s) configured. Refer to the *Cisco CallManager Configuration Guide*.

To add a default device profile for a new user of Cisco CallManager Extension Mobility, follow these steps:

Procedure

- Step 1** On the Cisco CallManager Administration page, choose **Device > Device Profile**. The page refreshes to the Find and List Device Profiles Page.
- Step 2** Choose the **Add a New User Device Profile** link in the upper right-hand corner. The User Device Profile Configuration page displays.

- Step 3** At the User Device Profile Name field, enter a name of your choice for the device profile. This text can be anything that describes this particular user device profile.
- Step 4** In the Phone Button Template field, for both the Cisco IP Phone Models 7960 and 7940, select **Default 7960** from the Phone Button Template drop-down list. The default applies to both Cisco IP Phones. See [Figure 3-13](#).

Figure 3-13 Associating a User Device Profile to a User

System Route Plan Service Feature Device User Application Help

Cisco CallManager Administration
For Cisco IP Telephony Solutions

CISCO SYSTEMS

User Device Profile Configuration [Add a new user device profile](#)
[Find/List Device Profiles](#)

Directory Numbers
Lines can be added after the new Device Profile is inserted in the database.

User Device Profile: New
Status: Ready

Insert Cancel Changes

User Device Profile Name* TestProfile

Description TestLoginProfile 1

Phone Button Template* Default 7960 (View button list)

Add-On Module 1 --- Not Selected --- (View button list)

Add-On Module 2 --- Not Selected --- (View button list)

* Indicates required item

586531

- Step 5** You can configure one or two Cisco IP Phone Expansion modules for this device profile by choosing from the add-on module drop-down lists.



Note

You may view a phone button list at any time by choosing the View button list link next to the phone button template fields. A separate window pops up, displaying the phone buttons for that particular expansion module.

- Step 6** Click **Insert**.
The Directory Number Configuration page appears.
- Step 7** At the Directory Number field, enter the directory number and click **Insert**.

- Step 8** The following prompt appears: The Directory Number has been assigned to the current device. Click OK to return to the current device.
- Click **OK**.
- Step 9** The page refreshes back to the User Device Profile Configuration page for this device profile.
- On the User Device Profile Configuration page, select **Update service**.
- Step 10** To update services, select the service which you added in the [“Adding the Logout Service” section on page 3-21](#).
- Step 11** Click **Continue**.
- Step 12** Click **Subscribe**.
-

Related Topics:

- [Adding the Logout Service, page 3-21](#)
- [Associating a User Device Profile to a User for Cisco CallManager Extension Mobility, page 3-28](#)

Associating a User Device Profile to a User for Cisco CallManager Extension Mobility

A User Device Profile is associated in the same way that physical devices are associated, starting with the User Global Directory. To associate a user device profile to a user for Cisco CallManager Extension Mobility, follow these steps:

Procedure

-
- Step 1** On the Cisco CallManager Administration page, choose **User > Add a New User**.
- Step 2** At the Add a New User screen, enter the first name (for example, jean), last name (for example, brody), and UserID (for example, jbrody).
- Step 3** At the User Password and Confirm Password fields, enter a password of your choice.
- Step 4** At the PIN field, enter a numeric Personal Identification Number (PIN) of your choice. Confirm the PIN number.

Step 5 To save your changes and add the user, click **Insert**.

Step 6 From the left pane, select **Extension Mobility** (see [Figure 3-14](#)).

Figure 3-14 Associating a User Device Profile to a User

System Route Plan Service Feature Device User Application Help

Cisco CallManager Administration
For Cisco IP Telephony Solutions

CISCO SYSTEMS

User Information

[Personal Information](#)
[Back to user list](#)

Available Profiles

Check All on Page Check All in Search No Default Profile

Type	Profile Name	Description	Default Profile
<input type="checkbox"/>	DefaultProfileForPhone2	DefaultProfileForPhone2	<input type="radio"/>
<input type="checkbox"/>	DefaultProfileForPhones		<input type="radio"/>
<input type="checkbox"/>	DefDevProfForTej	DefDevProfForTej	<input type="radio"/>
<input type="checkbox"/>	DefProfForAbid		<input type="radio"/>
<input type="checkbox"/>	DefProfForAppid	DefProfForAppid	<input type="radio"/>
<input type="checkbox"/>	DefProfForKathande		<input type="radio"/>
<input type="checkbox"/>	DefProfForLieu		<input type="radio"/>
<input type="checkbox"/>	DefProfForTest	DefProfForTest	<input type="radio"/>
<input type="checkbox"/>	TestProfile	TestProfile	<input type="radio"/>
<input checked="" type="checkbox"/>	TestProfile1	TestLoginProfile 1	<input type="radio"/>

56555

Step 7 Click **Select Profiles** to display the profile that you created in the “[Creating the Default Device Profile for a User](#)” section on page 3-26.

Step 8 Scroll and click on the box next to the default profile to select the appropriate profile.



Note The first profile checked becomes the default profile.

Step 9 Click **Update**.

Related Topics:

- [Creating the Default Device Profile for a User, page 3-26](#)
- [Configuring the Cisco IP Phones for Cisco CallManager Extension Mobility, page 3-30](#)

Configuring the Cisco IP Phones for Cisco CallManager Extension Mobility

To configure the Cisco IP phone for Cisco CallManager Extension Mobility, follow these procedures:

- [Configuring the Cisco IP Phone Models 7960 and 7940, page 3-30](#)
- [Subscribing to the Cisco CallManager Login Service, page 3-32](#)

Configuring the Cisco IP Phone Models 7960 and 7940

To configure a new or an existing Cisco IP Phone Model 7960 or 7940 for Cisco CallManager Extension Mobility, follow these steps:

Procedure

Step 1 On the Cisco CallManager Administration page, choose **Device > Phone**.

The Find and List Phones page displays.

Step 2 To configure an existing phone, perform the following steps:

- a. Choose the fields you want to use to locate a phone. See the *Cisco CallManager Administration Guide* for more information.



Note To find all phones registered in the database, choose Device Name from the list of fields, and choose “is not empty” from the list of patterns; then, click **Find**.

A list of devices matching the criteria appears.

- b. Select the box next to the device you want to configure and click on the device.
- c. Proceed to Step 4.

- Step 3** To configure a new phone, perform the following steps:
- Click **Add a New Phone** in the top right corner.
The Add a New Phone page displays.
 - Use a drop-down arrow to select your phone type: **Cisco 7960** or **Cisco 7940**.
 - Click **Next**.
 - Proceed to Step 4.
- Step 4** The Phone Configuration page displays (see [Figure 3-15](#)).

Figure 3-15 Configuring a Phone for Cisco CallManager Extension Mobility

The screenshot shows the Cisco CallManager Administration interface. At the top, there is a navigation menu with links for System, Route Plan, Service, Feature, Device, User, Application, and Help. Below the menu is a header with the Cisco CallManager Administration logo and the Cisco Systems logo. The main content area is titled 'Phone Configuration' and includes several sections:

- Directory Numbers:** A sidebar on the left shows 'Base Phone' with two lines: 'Line 1 - 1006' and 'Line 2 - Add new DN'.
- Phone Information:** Displays 'Phone: SEP003094C297BF (Auto 1006)', 'Registration: Registered with Cisco CallManager 172.21.12.66', and 'IP Address: 172.21.13.39'. The status is 'Ready'.
- Actions:** Buttons for 'Copy', 'Update', 'Delete', 'Reset Phone', and 'Cancel Changes'.
- Phone Configuration (Model = Cisco 7960):** A section for configuring the device, including:
 - Device Information:** Fields for MAC Address* (003094C297BF), Description (Auto 1006), Device Pool* (Default), Calling Search Space (< None >), Media Resource Group List (< None >), User Hold Audio Source (< None >), Network Hold Audio Source (< None >), and Location (< None >).
 - Phone Button and Add-on Module Template Information:** A field for Phone Button Template* (Default 7960).

On the right side of the page, there are links for 'Add a new phone', 'Update Speed Dial buttons', 'Update Services', and 'Back to Find/List Phones'. A vertical ID number '58690' is visible on the far right edge of the screenshot.

At the Phone Configuration page, enter the Media Access Control (MAC) address of the phone.

**Note**

The MAC address of the phone can be found on the back of the unit on the label next to the word MAC. It can also be found by using the Settings button on the Phone (79XX), then selecting Network Configuration. Under 3 MAC Address, the phone's MAC address appears.

- Step 5** Fill in the remaining parameters as required.
- Step 6** Click **Insert** when you are finished.
- Step 7** You will see a pop-up prompt: The phone has been inserted in the database. Would you like to add a directory number for line 1 of the phone now.
Click **OK**.
The Directory Number Configuration page displays.
- Step 8** Enter the DN of the phone you are configuring at the Directory Number field.
- Step 9** Click **Insert**.
- Step 10** Click **Update**.
- Step 11** You will see a pop-up prompt: Reset the phone to have the changes take effect. Click **OK**.
- Step 12** Proceed to the [“Subscribing to the Cisco CallManager Login Service”](#) section on [page 3-32](#).
-

Subscribing to the Cisco CallManager Login Service

To subscribe to the Cisco CallManager Login Service, follow these procedures:

Procedure

- Step 1** On the Cisco CallManager Phone Configuration page, select **Update Services**.
- Step 2** From the drop-down arrow, select the service (for example, login) which you added in the [“Adding the Login Service”](#) section on [page 3-19](#).
- Step 3** Click **Continue**.

- Step 4** Click **Subscribe**. Close the window.
- Step 5** On the Cisco CallManager Phone Configuration page, scroll down to the bottom of the page. Click the check box to **Enable Extension Mobility Feature** (see [Figure 3-16](#)).

Figure 3-16 Enabling Extension Mobility

Extension Mobility (Device Profile) Information

Enable Extension Mobility Feature

Log Out Profile

Log In User ID

Log In Time

Log Out Time

63142

- Step 6** At the Log Out Profile field, select **Use Current Device Settings**.
- This creates an Autogenerated Device Profile as the default device profile. When a logout is executed, the current configuration (the User Device Profile) is replaced by the Autogenerated Device Profile (the default device profile).
- See the “[Rules for Configuring Cisco CallManager Extension Mobility](#)” section on page 3-1 for information about configuring device profiles.
- Step 7** The remaining fields show the current device information regarding the login status of the device: Log in UserID; Log In Time; Log Out Time.
- Step 8** Click **Update**.

Related Topics:

- [Configuring the Cisco IP Phones for Cisco CallManager Extension Mobility, page 3-30](#)
- [Preparing the User for Cisco CallManager Extension Mobility, page 3-35](#)

Setting up Anonymous Access on IBM-340 platforms

If you are configuring Cisco CallManager Extended Services on an IBM-340 platform, make sure that the system is set to allow anonymous access to the Login Service web site. If your system is not set to allow anonymous access, you may encounter a Login Server Connection Error when attempting to log in to the phone.

To allow anonymous access, set the IIS to control the password. Perform the following steps:

Procedure

- Step 1** On the Cisco CallManager server, choose **Start > Programs > Administrative Tools > Internet Services Manager**.
 - Step 2** Expand the tree on the left side of the page: machine name > Default Web Site > LoginService
 - Step 3** Right click **LoginService** in the left pane and select **Properties**.
 - Step 4** Click the **Directory Security** tab.
 - Step 5** Under Anonymous access and authentication control, click the **Edit** button.
 - Step 6** Make sure that **Anonymous access** is checked. Click **Edit** for the account used for anonymous access.
 - Step 7** Verify that “Allow IIS to control password” is checked.
 - Step 8** Click **OK**.
 - Step 9** Click **OK**.
 - Step 10** Close Internet Services Manager.
-

Preparing the User for Cisco CallManager Extension Mobility

Once you have configured the system for Cisco CallManager Extension Mobility, provide the phone user with the following information:

- notification of the feature's availability
- the name you have given the login service and logout service for Cisco CallManager Extension Mobility (for example, login service and logout service)
- their password, UserID and PIN
- the URL for the Cisco IP Phone Menu Options web page for the user to change their password and PIN
- instructions on logging in and logging out, including any information on Service Parameters you have set defining login and logout (see [Setting the Service Parameters, page 3-23](#))

You can provide the following procedures to the phone user to enable them to use the Cisco CallManager Extension Mobility feature:

- [Logging in to Cisco CallManager Extension Mobility, page 3-36](#)
- [Logging out of Cisco CallManager Extension Mobility, page 3-37](#)

Logging in to Cisco CallManager Extension Mobility

To log in to Cisco CallManager Extension Mobility, perform the following steps:

Procedure

- Step 1** From a Cisco IP 7960/7940 Phone, press the services button.
- Step 2** From the list of displayed services, select the login service defined by your administrator for Cisco CallManager Extension Mobility (for example, login service).
- Step 3** The phone prompts you to enter your UserID and Personal Identification Number (PIN).
- Step 4** Click **Submit** to access your login service or click **Cancel** to exit.
The phone adopts your user device profile information such as directory number(s), speed dials and services.
-  **Note** Your administrator provides you with your password, UserID, PIN, and the URL for your Cisco IP Phone User Options web page. To change your password and PIN, go to the web page and follow the instructions.
-
- Step 5** Proceed with using the phone.
-

Logging out of Cisco CallManager Extension Mobility

To log out of Cisco CallManager Extension Mobility, perform the following steps:

Procedure

- Step 1** From a Cisco IP 7960/7940 Phone, click on the Services button.
 - Step 2** From the list of displayed services, select the logout service defined by your administrator for Cisco CallManager Extension Mobility (for example, logout service).
 - Step 3** The phone returns to its original user device profile.
-

■ Preparing the User for Cisco CallManager Extension Mobility



Configuring Cisco CallManager AutoAttendant

This section provides information about configuring Cisco CallManager and the Cisco Customer Response Application Engine (Cisco CRA Engine) in preparation for deploying your Cisco CallManager AutoAttendant (Cisco CallManager AA).

Perform the following procedures to configure your Cisco CallManager AA:

1. [Configuring Cisco CallManager for Cisco CallManager AutoAttendant, page 4-2](#)
2. [Configuring the Cisco CRA Engine for Cisco CallManager AutoAttendant, page 4-6](#)
3. [Customizing Cisco CallManager AutoAttendant, page 4-12](#)

Configuring Cisco CallManager for Cisco CallManager AutoAttendant

Before you can use Cisco CallManager AutoAttendant (Cisco CallManager AA), you must configure Cisco CallManager. The following steps illustrate the basic configuration principles and describe a simple configuration to test your installation.

1. [Adding CTI Route Points in Cisco CallManager, page 4-2](#)
2. [Adding CTI Ports in Cisco CallManager, page 4-3](#)
3. [Creating a Cisco CallManager User for Cisco CallManager AutoAttendant, page 4-4](#)

Adding CTI Route Points in Cisco CallManager

To add a CTI route point in Cisco CallManager for Cisco CallManager AutoAttendant (Cisco CallManager AA), perform the following steps:

Procedure

-
- Step 1** On the Cisco CallManager server, choose **Start > Programs > Cisco CallManager 3.1 > CallManager Administration**. You can also connect to the Cisco CallManager web server using any computer on your network by using the following URL:
- `http://servername/ccmAdmin`
- where *servername* is the DNS name or IP address of your Cisco CallManager server.
- You will be prompted for a network username and password.
- Step 2** Choose **Device > Add a New Device**.
- Step 3** Use the Device Type drop-down arrow to select **CTI Route Point**.
- Step 4** Click **Next**.
- Step 5** In the Device Name field, enter a name of your choice for the CTI route point. Choose a name that is descriptive.

- Step 6** In the Device Pool field, select the device pool for this CTI route point. If no other pool has been created, select **Default**.
- Step 7** Click **Insert**.
- Step 8** In the left pane of the CTI Route Point Configuration window, click **Line 1-click to add**.
- Step 9** In the Directory Number field, enter the directory number for this CTI route point. This is the number that users will dial to reach this CTI route point (for example, 4000).
- Step 10** Click **Insert and Close**. Now you need to add CTI ports to Cisco CallManager.
-

Adding CTI Ports in Cisco CallManager

All CTI ports in a CTI port group must have consecutive directory numbers. For example, if you want four CTI ports in a particular CTI port group, and the first is number 9001, the rest of the ports will automatically be configured 9002 through 9004.

To add CTI ports in Cisco CallManager, perform the following steps:

Procedure

- Step 1** On the Cisco CallManager server, choose **Start > Programs > Cisco CallManager 3.1 > CallManager Administration**. You can also connect to the Cisco CallManager web server using any computer on your network by using the following URL:
- `http://servername/ccmAdmin`
- where *servername* is the DNS name or IP address of your Cisco CallManager server.
- Step 2** Choose **Device > Add a New Device**.
- Step 3** Use the Device Type drop-down arrow to select **Phone** and click **Next**.
- Step 4** Use the Phone Type drop-down arrow to select **CTI Port** and click **Next**.
- Step 5** In the Device Name field, enter a name for the device (for example, CTI_Port1).

- Step 6** Use the Device Pool drop-down arrow to select the device pool for this CTI port. If there is no other pool, select **Default**.
- Step 7** Click **Insert**.
- Step 8** In the left pane of the Phone Configuration window, click **Line 1 - click to add**.
- Step 9** In the Directory Number field, enter the directory number of this CTI port (for example, 4001).



Note CTI port groups must contain sequential CTI port directory numbers.

- Step 10** Click **Insert and Close**.
- You can continue to add ports using consecutive numbers. After you have added and configured CTI ports for Cisco CallManager AA, configure a Cisco CallManager user for the Cisco CallManager AA.

Creating a Cisco CallManager User for Cisco CallManager AutoAttendant

To create a Cisco CallManager user for Cisco CallManager AutoAttendant (Cisco CallManager AA), perform the following steps:

Procedure

- Step 1** On the Cisco CallManager server, choose **Start > Programs > Cisco CallManager 3.1 > CallManager Administration**. You can also connect to the Cisco CallManager web server by using the following URL:
- `http://servername/ccmAdmin`
- where *servername* is the DNS name or IP address of your Cisco CallManager server.
- You will be prompted to enter the network password.
- Step 2** Choose **User > Add a New User**.

- Step 3** In the Add a New User page, enter the first name (for example, JTAPI), last name (for example, User), and UserID (for example, JTAPIUser).
- Step 4** Enter a password of your choice in the User Password and Confirm Password fields.
- Step 5** At the PIN field, enter a numeric Personal Identification Number (PIN) of your choice. Confirm the PIN number.
- Step 6** Click the **Enable CTI Application Use** check box.

**Caution**

When you create a Cisco CallManager user for Cisco CallManager AA, you must click the **Enable CTI Application Use** check box on the Cisco CallManager Add a New User page. If you do not click the **Enable CTI Application Use** check box, the Cisco CRA Engine will be unable to receive calls from Cisco CallManager.

- Step 7** Click **Associate Devices**.
- Step 8** In the User Devices Assignment Window, check the boxes associated with the Device Name fields.
- In order to use the examples provided here, check the following items.
- AA_RP
 - CTI_Port1
 - CTI_Port2
- Step 9** Make sure the **No Primary Extension** radio button is selected.
- Step 10** Click **Insert**.

Configuring the Cisco CRA Engine for Cisco CallManager AutoAttendant

Once you have configured Cisco CallManager for Cisco CallManager AutoAttendant, configure the Cisco Customer Response Application (Cisco CRA) Engine to communicate with Cisco CallManager and the Cisco IP Telephony Directory. To do this, perform the following procedures:

1. [Configuring Directory Information, page 4-6](#)
2. [Configuring the JTAPI Subsystem on the Cisco Customer Response Application Engine, page 4-9](#)
3. [Adding a CTI Port Group, page 4-10](#)
4. [Adding a New Cisco CallManager AutoAttendant, page 4-10](#)

Configuring Directory Information

The Cisco IP Telephony Directory server stores two types of information used by your Cisco Customer Response Application (Cisco CRA) Engine. First, it stores directory information, which includes CTI port and routing configurations. Second, it contains the repository subdirectory, which stores the applications you create with the Cisco CRA Engine.

If your Cisco IP Telephony solution includes one application server and one Cisco IP Telephony directory, the directory configuration information will be the same for both the directory and the repository.

It is also possible for the application server to receive directory information from one Cisco IP Telephony Directory and application script from a repository on another server. In this scenario, the directory and repository would have different configurations.

For efficient management of resources, each type of configuration is stored as a profile on the Cisco IP Telephony Directory server. In the event of a system failure or reallocation of application servers, you can upload a directory profile from the Cisco IP Telephony Directory to a replacement application server.

**Note**

Directory profiles can only be used by one application server at a time.

Repository profiles can be used to centralize the storage of application script. Unlike directory profiles, repository profiles may be shared by more than one application server.

To configure Directory information on the application server, perform the following steps:

Procedure

Step 1 Connect to the Application Administration web server by using the following URL:

`http://servername/AppAdmin`

where *servername* is the DNS name or IP address of your application server.

If you are using the computer that is running the application server, you can connect to the web pages by choosing:

**Start > Programs > Cisco CRA Administrator
> Application Administration.**

You will be prompted to enter the network username and password.

Step 2 At the Cisco Customer Response Setup page, click **Setup**.

Step 3 Use [Table 4-1](#) to fill in the fields.

Table 4-1 Directory Configuration

Field	Description	Default for DC Directory
Directory hostname	Hostname or IP address of the Cisco IP Telephony Directory server used by the current Application Engine profile.	
Directory port number	The port number of the Cisco IP Telephony Directory.	8404
Directory user (DN)	The user name (also called the distinguished name) configured on the directory server for the user that has permission to modify the Cisco IP Telephony tree and object entries.	cn=Directory Manager, o=cisco.com
Directory password	The password for the Directory user.	ciscocisco
Base Context	The branch of the Cisco IP Telephony Directory tree that contains the Cisco configuration information.	o=cisco.com
Server Type	The type of LDAP directory—MS Active Directory, Netscape Directory Server 4.0, or DC Directory.	DC Directory
Configuration Profile Name	The profile name that identifies this engine configuration.	

Step 4 Click the **Initialize profile** check box and click **OK**.

Step 5 At the Install Application Scripts Installation completed prompt, click **Main Menu**.

Step 6 If you want to maintain separate profiles for your directory and repository configurations, click the **Use a Different Repository Profile** check box.



Note

By default, the application server will use the directory configuration information to build the application repository configuration.

Step 7 Click **Update** to enter your changes.

If you clicked the Use a Different Repository Profile check box, the repository configuration window appears. Complete these fields with the configuration information appropriate for your repository directory.

Configuring the JTAPI Subsystem on the Cisco Customer Response Application Engine

After you complete the directory configuration, you must configure the JTAPI subsystem on the Cisco Customer Response Application Engine (Cisco CRA Engine). The Cisco CRA Engine uses the JTAPI subsystem to send and receive calls from Cisco CallManager.

To configure the JTAPI Subsystem, perform the following steps:

Procedure

- Step 1** At the Application Administration Main Menu, click the **JTAPI** link in the Options column.
 - Step 2** In the CallManager field, enter the IP address or DNS name of the Cisco MCS running Cisco CallManager.
 - Step 3** In the Username field, enter the Cisco CallManager UserID you defined in [“Creating a Cisco CallManager User for Cisco CallManager AutoAttendant” section on page 4-4](#) (for example, JTAPIUser).
 - Step 4** Enter the password you defined for this UserID in the Password field.
 - Step 5** Click **Update** to enter your changes.
-

Adding a CTI Port Group

To add a CTI Port Group, perform the following steps:

Procedure

- Step 1** On the JTAPI configuration page, click the **Add new CTI Port Group** link.
- Step 2** On the Add a new CTI Port Group page, use the Type drop-down arrow to select **Applications** and click **Next**.
- Step 3** On the CTI Port Group Configuration page, enter **1** in the Number field.
- Step 4** In the Initial CTI Port field, enter the first CTI Port directory number you established in Step 11 of the [“Adding CTI Ports in Cisco CallManager”](#) section on page 4-3. If you are using the provided sample values, enter **4001**.
- Step 5** In the Last CTI Port field, enter the CTI Port directory number of the last CTI port you defined in Cisco CallManager. If you are using the provided sample values, enter **4004**.



Note CTI port groups must contain sequential CTI port directory numbers.

- Step 6** Click **Update**.
-

Adding a New Cisco CallManager AutoAttendant

When you have configured the appropriate subsystem on the Cisco Customer Response Application (Cisco CRA) Engine, you can use one of the sample scripts to create an application and start the Cisco CRA Engine.

To add a new Cisco CallManager AutoAttendant, perform the following steps:

Procedure

- Step 1** Connect to the Application Administration web server by using the following URL:
- `http://servername/AppAdmin`
- where *servername* is the DNS name or IP address of your Cisco CRA Engine.
- Step 2** At the Application Administration Main Menu, click the Telephony Application link in the Options column.
- Step 3** Click the **Add New Application** link on the Application page.
- Step 4** At the Application Configuration page, use the drop-down arrow to select the aa.aef script. The system populates the Script Name field with “aa.aef.” Click **Next**.
- Step 5** Enter a name for the application in the Application Name field.
- Step 6** At the Application Parameters Configuration page, provide the CTI route point for this Application (for example, 4000).
- Step 7** In the Maximum Number of Sessions field, enter the number of CTI ports you added in Cisco CallManager. If you are using the provided sample values, enter **4**.
- Step 8** In the OperExtn field, enter the extension of the phone that will be used by the human operator and click **Update**.
- Step 9** Select **Main Menu > Engine**.
- Step 10** On the Engine page, click **Start**.

When the Engine status is *running* and the subsystems indicate they are *in service*, the Cisco CallManager AA is functional. You can call into the Cisco CallManager AA by dialing the directory number of the CTI route point you added to Cisco CallManager. If you are using the provided sample values, dial 4000.

Customizing Cisco CallManager AutoAttendant

By default, Cisco CallManager AA plays back a prerecorded welcome prompt and spells out user names. You can customize your Cisco CallManager AA by adding your own welcome prompt and recordings of your users' spoken names:

- [Configuring an Instance of Cisco CallManager AutoAttendant, page 4-12](#)
- [Configuring Prompts, page 4-13](#)

Configuring an Instance of Cisco CallManager AutoAttendant

To configure an existing Cisco CallManager AutoAttendant (Cisco CallManager AA), perform the following steps:

Procedure

- Step 1** Select **Applications** from the application administration main menu.
- Step 2** Select the instance of Cisco CallManager AA that you wish to configure and click **Next**.
- Step 3** You can make the following configuration changes:
- Application Name—the name of the application.
 - CTI Route Point—the number used to reach this application.
 - Maximum Number of Sessions—the maximum number of sessions possible for this application.
 - Enabled—whether the application is enabled or not.
 - operExtn—the extension of the phone that will be used by the human operator.
 - welcomePrompt—the prompt used as the welcome prompt for Cisco CallManager AA. See the “[Configuring the Welcome Prompt](#)” section on [page 4-15](#) for information about how to upload prompts.
-

Configuring Prompts

The Media Configuration page also allows you to upload new prompts to the Cisco CRA Engine, modify existing prompts, and configure the UDP port.

The following topics are included:

- [General Media Configuration, page 4-13](#)
- [Recording the Welcome Prompt, page 4-14](#)
- [Configuring the Welcome Prompt, page 4-15](#)
- [Uploading a Spoken Name, page 4-16](#)
- [Uploading a Batch of Spoken Names, page 4-17](#)

General Media Configuration

The General Media Configuration page shows the two directory paths that the Cisco CRA Engine uses to store System and User prompts, and the Starting UDP Port field.

The prompt path information shown on the General Media Configuration page is for your information only. You cannot modify these paths. System prompts are general-use type prompts, and many are included with Cisco CRA. (You may also record your own). User prompts are the prompts you create for specific applications.

The Starting UDP port field is used to specify the first UDP port for sending and receiving UDP data. Cisco Customer Response Applications uses the User Datagram Protocol (UDP) protocol to send and receive media packets over the IP network. The Starting UDP port field is pre-populated with a default value. The default value for this field corresponds to the normal configuration for Cisco networking equipment and ensures the highest possible audio quality for calls to Cisco Customer Response Applications.

Recording the Welcome Prompt

You can record prompts for Cisco CallManager AA on any computer using Microsoft Sound Recorder. Save the prompt as a .wav file in CCITT (μ -law) 8kHz, 8-bit, Mono format. (You can use another audio application to record the welcome prompt if it supports this format.)

To record a prompt using Microsoft Sound Recorder, perform the following steps:

Procedure

-
- Step 1** Select the following option from the Windows Start menu:
Programs > Accessories > Multimedia > Sound Recorder.
- Step 2** Click the **Record** button (red), and record your greeting into the microphone.
- Step 3** Click the **Stop** button (black) when you have finished recording.
- Step 4** To check your greeting:
- Click the **Rewind** button (left-pointing arrows) or drag the slider back to the beginning of the recording.
 - Click the **Play** button (right-pointing arrow) button.
- Step 5** When you are satisfied with your greeting, save the recording.
- Select **File > Save As**.
 - Click **Change** to set the recording options. (You can also do this by selecting **Properties** from the Sound Recorder File menu).

Figure 4-1 Sound Selection Window

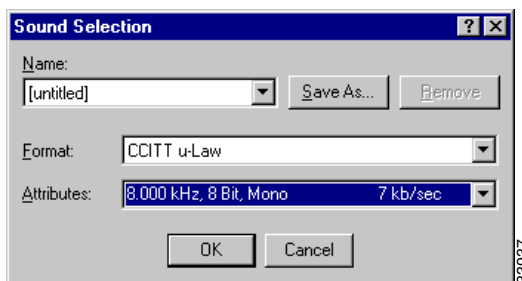

- c. Use the Format drop-down arrow, select **CCITT μ -law**.
 - d. Use the Attributes drop-down arrow to select **8.000 kHz, 8 Bit, Mono 7 kb/sec**.
 - e. Click **Save As** and enter a name for this format.
 - f. Click **OK** to close the Sound Selection window.
 - g. Browse to the directory of your choice, preferably a directory that you have set aside for prompts.
 - h. Enter the file name, and click **Save**.
-

Configuring the Welcome Prompt

The Media Configuration Page allows you to upload new prompts, or to modify existing prompts stored on the Cisco CRA Engine.

To add or modify prompts, perform the following steps:

-
- Step 1** On the Application Administration Main Menu, click **Media**. The system displays the Media Subsystem Configuration page.
 - Step 2** Click the **Prompts** link. The system displays the Prompt Configuration page.
 - Step 3** To replace an existing prompt with a new .wav file, click the arrow in the Upload column for the prompt you want to modify. To create a new prompt, click the **Add a new prompt** link. The system displays the Prompt File Name page.
 - Step 4** Enter the name of the .wav file you want to use to replace the existing prompt, or to use as a new prompt. If you are adding a new prompt, enter a name for the prompt as it resides on the Cisco application server.
 - Step 5** When you have provided the .wav file and prompt name information, click **Upload**.
-

Uploading a Spoken Name

To upload Cisco CallManager AutoAttendant (Cisco CallManager AA) spoken names in your users' voices, upload the corresponding .wav files into the Directory:

Procedure

- Step 1** Ask users to record their names in the manner prescribed in the “[Recording the Welcome Prompt](#)” section on page 4-14, and to save their files as `userId.wav`, where `userId` is their user name.
- Step 2** Using the Cisco application server computer (this process cannot be done remotely), connect to the spoken name web page with the following URL:
`http://servername/SpokenNameUpload`
where `servername` is the DNS name or IP address of your application server.
You can also choose **Start > Programs > Cisco IP IVR > SpokenNameUpload**.
- Step 3** Click the **Change** button and click **OK**.
- Step 4** Click the **Browse** button to locate the spoken name wav file you would like to upload. The Choose file navigation window appears.
- Step 5** When you have located the appropriate file, click **Open**.
- Step 6** Confirm that you have identified the appropriate path and file and click **Upload**.
-

Uploading a Batch of Spoken Names

If you need to upload a large number of spoken names at once, use the SpokenNameBulkUpload.bat utility, provided on the application server. To upload a batch of spoken names, perform the following steps:

Procedure

-
- Step 1** Ask users to record their names in the manner prescribed in the “Recording the Welcome Prompt” section on page 4-14, and to save their files as *userId.wav*, where *userId* is their user name.
- Step 2** Collect these files in a directory on the Cisco application server computer.
- Step 3** Upload the contents of the local directory to your Cisco IP Telephony Directory using the following DOS command:
- ```
SpokenNameBulkUpload directory true|false
```
- where *directory* is the directory on your hard drive where the .wav files are located.
- Use the true/false parameter to choose to replace existing spoken names in the Cisco IP telephony directory or not:
- true—replaces any spoken name .wav files in the directory with spoken name .wav files of the same name.
  - false—does not replace spoken name .wav files in the directory with spoken name .wav files of the same name.
-





# Administering Cisco CallManager Extended Services

---

This section provides information about managing the Cisco CallManager Extended Services after you have configured the services. Topics include:

- [Managing the Cisco CRA Engine, page 5-1](#)
- [Using Cisco CRA Real-time Reporting, page 5-8](#)
- [Using Cisco CRA Historical Reporting, page 5-13](#)

## Managing the Cisco CRA Engine

When you click the **Engine** link on the Application Administration main menu, the system displays the Engine Control page.

The Engine Control displays the state of the Cisco Customer Response Application (Cisco CRA) Engine and the Cisco CRA subsystems. It also allows you to start and stop the application engine. You may need to stop the application engine for system changes or upgrades or for troubleshooting purposes.

Use the links on the Engine Control page to perform the following operations:

- [Starting and Stopping the Cisco CRA Engine, page 5-2](#)
- [Changing Engine Configuration, page 5-3](#)
- [Setting Trace File Options, page 5-4](#)

## Starting and Stopping the Cisco CRA Engine

You can use the Cisco Customer Response Application (Cisco CRA) Administration web pages to start and stop the Cisco CRA Engine. You can also control the Cisco CRA Engine from the service panel in the Administrative Tools portion of the Windows NT control panel.

To start and stop the application engine from your web browser, perform the following steps.

### Procedure

---

- Step 1** Access the Application Administration main menu, by entering the following URL in the Location field of your browser:

`http://<servername>/AppAdmin`

where *servername* is the Domain Name Service (DNS) name or IP address of your application server.

Alternatively, if you are on the application server computer, you can choose

**Start > Programs > Cisco CRA Administrator > Application Administrator.**

The system displays the Application Administration main menu.

- Step 2** To go to the Engine Control page, click **Engine**.

The Engine Control page provides specific information about each application session, such as the start time and the parties involved.

- Step 3** To start the engine, click **Start Engine**.

This link starts the Windows service, “Cisco Application Engine.”



**Note**

---

The status may display “Starting” for as long as 10 to 30 seconds.

---

- Step 4** To shut down the application engine, click **Stop Engine**.
-



## Changing Engine Configuration

To modify the engine parameters for the profile you have chosen, perform the following steps:

### Procedure

- 
- Step 1** Select **Engine > Configure** from the Application Administration main menu. The system displays the Engine Configuration page.
- Step 2** To configure the engine, enter the appropriate values in the fields described in [Table 5-1](#).

**Table 5-1 Engine Configuration**

| Field                                 | Description                                                                                                                                                                                                               |
|---------------------------------------|---------------------------------------------------------------------------------------------------------------------------------------------------------------------------------------------------------------------------|
| RMI Port Number                       | The port number used by the engine to serve remote method invocation (RMI) requests.                                                                                                                                      |
| Maximum Number of Executed Steps      | Do not change the default value.<br>This is the maximum number of steps any script is allowed to execute before the engine terminates the application. It is intended to prevent a script from running “infinitely” long. |
| Maximum Number of Concurrent Sessions | Maximum number of concurrent tasks. If a call arrives while all sessions are running, it is delayed until a session is free.                                                                                              |

- Step 3** Click **Update** to save the changes.
-

## Setting Trace File Options

Trace files are logs that record application engine activity. You can use the trace file to identify system or application script problems. Because recording all information about engine activity can create a file that is large and difficult to read, you can specify to the trace file which items you want to record.

This section describes how you perform the following tasks:

- [Configuring the Trace File, page 5-4](#)
- [Setting Trace Level Options, page 5-5](#)
- [Viewing Trace Files, page 5-7](#)

## Configuring the Trace File

To configure the Trace File options, perform the following steps:

### Procedure

**Step 1** Select **Engine > Trace Configuration** from the Application Administration main menu.

The system displays the Trace File Options page.

**Step 2** To configure trace files and syslog files, enter the appropriate values in the fields described in [Table 5-2](#).

**Table 5-2** Trace file options

| Field or option   | Description                                                                                                          |
|-------------------|----------------------------------------------------------------------------------------------------------------------|
| Trace File Output | Enable this check box to store trace file output in the filename specified below.                                    |
| Filename          | The “base” trace file name. Filenames consist of the base name plus the file number (for example, CiscoMIVR001.log). |

**Table 5-2** Trace file options (continued)

| Field or option       | Description                                                                                                                                                                    |
|-----------------------|--------------------------------------------------------------------------------------------------------------------------------------------------------------------------------|
| Number of Trace Files | The number of trace files to rotate.<br>When the last file is reached, the trace file re-starts from “1”. If the engine is restarted, tracing is re-started in the first file. |
| Trace File Size       | The maximum size (in bytes) of the trace file. After the file reaches this size, the system moves to the next file.                                                            |

**Step 3** Click **Update** to save your changes.

## Setting Trace Level Options

The Trace Configuration page also provides a series of check boxes that set the trace level for various engine activities. The trace levels are as follows:

- **Debug**—most verbose, to be used primarily for debugging and troubleshooting.
- **Informational**—describes the transition state (for example, system start, system stop)
- **Notification**—notifies the user that something has happened (for example, maximum number of sessions exceeded)
- **Warning**—notifies the user of error conditions that can be recovered from and that do not result in loss of service

Two groups of trace level activity options; active and inactive. You can make changes to the parameters of the active options without restarting the Application Engine, and the trace file will reflect your changes. The inactive options require that you restart the application engine to reflect any changes you made.

Table 5-3 summarizes the active engine activities that you can monitor.

**Table 5-3 Active Trace level activity options**

| Field or option    | Description                                |
|--------------------|--------------------------------------------|
| ADM                | Administration Client                      |
| APP_MGR            | Application Manager                        |
| ENG                | Application Engine                         |
| GENERAL_STEPS      | General Steps                              |
| ICD_HDM            | ICD Historical Data Manager                |
| ICD_RTDM           | ICD Real Time Data Manager                 |
| LIB_LDAP           | LDAP Library                               |
| LIB_MEDIA          | Media Library                              |
| LIB_RMI            | Remote Message Interface (RMI) Library     |
| LOG_MGR            | Log Manager                                |
| RPT                | Reporting                                  |
| SS_APP             | Application Subsystem                      |
| SS_CM              | Contact Manager Component                  |
| SS_DB              | Database Subsystem                         |
| SS_EMAIL           | Email Subsystem                            |
| SS_HTTP            | HTTP Subsystem                             |
| SS_RM              | Resource Manager Component                 |
| SS_RMCM            | Resource Manager Contact Manager Subsystem |
| SS_TEL             | JTAPI Subsystem (Telephony)                |
| STEP_CALL_CONTROL  | Call Control Steps                         |
| STEP_ICD           | ICD Steps                                  |
| STEP_MEDIA_CONTROL | Media Control Steps                        |

Table 5-4 lists the inactive Trace level options activities that can be monitored.

**Table 5-4 InactiveTrace Level options**

| Field or option | Description                             |
|-----------------|-----------------------------------------|
| CCUSER_STEPS    | Extension Mobility Steps                |
| DB_STEPS        | Database Steps                          |
| DOCUMENT_STEPS  | Document Steps                          |
| ICM_STEPS       | Intelligent Call Management (ICM) Steps |
| IO_STEPS        | Input/Output Steps                      |
| IVR_STEPS       | IVR Steps                               |
| JAVA_STEPS      | Java Steps                              |
| LIB_DIRECTORY   | Directory Library                       |
| MESSAGING_STEPS | Messaging Steps                         |
| STEP_AA         | AutoAttendant Steps                     |
| WEB_STEPS       | Web Steps                               |
| XML_STEPS       | XML Steps                               |

## Viewing Trace Files

After you have selected the trace file options that you want to record, restart the Cisco CRA Engine (if you have modified inactive trace file options). After you observe enough engine activity to provide useful data, you can download and view the contents of the new trace file.

To view trace files, click **Trace files** on the Engine Control page. To display the trace file, click on a filename.

# Using Cisco CRA Real-time Reporting

The Cisco IP Telephony system provides a real-time reporting utility, implemented as a Java applet communicating with the application server through remote method invocation (RMI). You can use this utility to generate reports on application activity.

This section covers the following topics:

- [Installing the Real-time Reporting Tool, page 5-8](#)
- [Applying the Real-time Reporting Tool, page 5-9](#)

## Installing the Real-time Reporting Tool

To use Cisco CRA real-time reporting from a computer other than the application server, you need to install the application by performing the following steps:

### Procedure

- 
- Step 1** Access the Application Administration main menu, by entering the following URL in the Location field of your browser:
- ```
http://<servername>/AppAdmin
```
- where *servername* is the Domain Name Service (DNS) name or IP address of your application server.
- The system displays a dialog box requiring your Cisco Customer Response Application (Cisco CRA) administrator username and password.
- Step 2** Enter your Cisco CRA administrator name and password and click **OK**.
- Step 3** Click **Plug-in**.
- The system displays the Plug-ins page.
- Step 4** Click the **Reporting Client** link.
- The system displays the **Save As...** dialog box.

Step 5 Specify a target directory for the installer and click **Save**.

After the download completes, double-click **CiscoCRA2_1Reporting.exe** and follow the prompts.

You can connect to the reporting windows by entering the URL of the application server in your browser window.

**Caution**

You must always use a valid host name or IP address. You cannot use the alias *localhost*, even when running the browser locally on the application server.

Applying the Real-time Reporting Tool

To start the real-time reporting utility, click **Real-Time Reporting** on the Application Administration main menu.

The system displays the Application Administration Reporting page. You can use this page to generate a variety of reports on the activity of your application engine.

The following options are available:

- [Viewing Overall Application Engine Activity, page 5-9](#)
- [Monitoring Activity by Application, page 5-11](#)
- [Monitoring Activity by Task, page 5-12](#)
- [Resetting Statistics, page 5-12](#)
- [Printing Reports, page 5-13](#)

Viewing Overall Application Engine Activity

To view overall application engine activity, select the **System Totals** option from the Reporting page.

This window shows the total activity for the application engine for a 24-hour period, updated at a regular interval (the default is three seconds).

Table 5-5 summarizes the meaning of each field on this page.

Table 5-5 System Totals

Field	Description
Total Sessions	Total number of sessions run since the timestamp (“Data Collected Since”)
Max Concurrent Sessions	Maximum number of tasks that can run at the same time.
Data Collected Since	Time when data collection started. The system resets automatically at midnight. You can manually reset the statistics by choosing Reset Stats from the Tools Menu. Restarting the application server will also reset the statistics.
Running Sessions	Number of tasks currently running.
Completed Sessions	Number of tasks completed without problems (exceptions).
Aborted Sessions	Number of tasks that an unhandled exception terminated.
Running Rate	The percentage of total tasks that are currently running.
Completion Rate	Percentage of total tasks that completed without errors.
Aborted Rate	Percentage of total tasks that terminated due to an unhandled exceptions.
Handled Rate	Percentage of total tasks for an application that have been handled. The system designates a task as handled if the application has reached the Session Handled step.
Abandoned Rate	Percentage of total sessions that were not handled for an application. If the Cisco IP Telephony application does not include a Session Handled step, the system counts all tasks associated with that application as abandoned. This also happens when someone who has called in to an application hangs up before the Session Handled step executes.

Monitoring Activity by Application

To monitor activity by application, select the **Application Activity** option from the Reporting page.

The system displays the Application Activity page.

[Table 5-6](#) summarizes the meaning of each field on this page.

Table 5-6 Application Activity

Field	Description
Application	Name of application. The application name is the name specified in the Application Configuration page.
Total Sessions	Total sessions for a specific application.
Completed Sessions	Number of sessions completed for an application without problems (exceptions).
Running Sessions	Number of sessions currently running.
Aborted Sessions	Number of sessions that were terminated for an application by an unhandled exception.
Handled Rate	Percentage of total sessions that have been handled. The system designates a task as handled if the application reaches the Session Handled application step.
Abandoned Rate	Percentage of total sessions that were not handled. If the application does not include a Session Handled step, the system counts all tasks associated with that application as abandoned.

Monitoring Activity by Task

To monitor activity by task, select the **Task Activity** option on the Reporting page.

Table 5-7 summarizes the meaning of each field on this page.

Table 5-7 Task Activity

Field	Description
Task ID	The identifier associated with the task started for the application or VRU script.
Parent ID	Task ID of task that invokes this VRU script (this field is left blank for an application)
Media ID	Cisco CallManager identifier or the call associated with this application.
Application	Name of application or VRU script associated with this task. The application name is the name of the application definition (.aef) file.
Start Time	Time the sessions for the application began execution.
Duration	Application execution time in seconds.
Source ID	Caller extension of incoming call. (CLID)
Destination ID	Called extension to reach application associated with this task (configured route point directory number).

Resetting Statistics

The system automatically resets the accumulated statistics every day at 12:00 AM (by the application server system clock). You can also manually reset the statistics by choosing: **Tools > Reset Stats** on the Reporting page.

Printing Reports

To create a printable version of a report, perform the following steps:

Procedure

-
- Step 1** Choose the Report you want to print from the Reports menu on the Reporting page.
- Step 2** Choose **Tools > Open Printable**
- The system opens a printable version of the report in a new browser window.
- Step 3** Choose Print from the File menu to print the report.
-

Using Cisco CRA Historical Reporting

In addition to viewing Real Time reports, you can view accumulated Cisco Customer Response Application (Cisco CRA) activity in historical reports. The historical reports record the same parameters that are used in the real time reporting feature.

When you enable historical reporting, the system automatically saves reports as .csv files to the Cisco CRA server hard disk. You can open the .csv files with a spreadsheet program like Microsoft Excel.

This section covers the following topics:

- [Viewing IP IVR Historical Reports, page 5-14](#)
- [Enabling Historical Reporting, page 5-15](#)
- [Changing Historical Reporting Parameters, page 5-16](#)

Viewing IP IVR Historical Reports

The system saves a report of IP IVR activity to the Cisco CRA server hard disk every 24 hours. The file is named with the date of the recorded activity using the following convention:

servername.year.month.day.csv

where *servername* is the Domain Name Service (DNS) name of your application server.

To view a historical report, perform the following steps.

Procedure

- Step 1** Access the Application Administration main menu, by entering the following URL in the Location field of your browser:
- `http://<servername>/AppAdmin`
- where *servername* is the Domain Name Service (DNS) name or IP address of your application server.
- Alternatively, if you are on the application server computer, you can choose
- Start > Programs > Cisco CRA Administrator > Application Administrator.**
- Step 2** On the Application Administration Main Menu page, click the **Historical Reporting** link.
- Step 3** On the Historical Reporting page, click the name of the report you want to download.
- Step 4** Follow the prompts to save the report to your local hard disk or open the copy of the file that is on the server.
-

Enabling Historical Reporting

To enable historical reporting, perform the following steps:

Procedure

- Step 1** Access the Application Administration main menu, by entering the following URL in the Location field of your browser:
- `http://<servername>/AppAdmin`
- where *servername* is the Domain Name Service (DNS) name or IP address of your application server.
- Alternatively, if you are on the application server computer, you can choose
- Start > Programs > Cisco CRA Administrator > Application Administrator.**
- Step 2** Click the **Engine** link.
- Step 3** Click the **Configure** link on the left side of the web page.
- Step 4** Make sure the Historical Reporting Status check-box is checked
-

Changing Historical Reporting Parameters

The Cisco CRA Engine generates historical reports on a daily basis. The system stores these reports on your Cisco CRA server hard disk. To preserve hard disk space, you can limit the number of historical reports that your Cisco CRA system stores.

The default setting is 90 days. This means that the system deletes historical reporting files that are more than 90 days old.

To change this value, perform the following steps:

Procedure

- Step 1** Access the Application Administration main menu, by entering the following URL in the Location field of your browser:

`http://<servername>/AppAdmin`

where *servername* is the Domain Name Service (DNS) name or IP address of your application server.

Alternatively, if you are on the application server computer, you can choose

Start > Programs > Cisco CRA Administrator > Application Administrator

- Step 2** Click the **Engine** link.
- Step 3** Click the **Configure** link on the left side of the web page.
- Step 4** In the Number of days to Preserve Historical Report Files field, enter your preferred value.
-



Troubleshooting Cisco CallManager Extended Services

This section provides information on troubleshooting error messages for Cisco CallManager Extended Services. The following topics are included:

- [Clearing Problems with Cisco CallManager Extension Mobility, page 6-1](#)
 - [Clearing Problems with Cisco CallManager AutoAttendant, page 6-5](#)
-

Clearing Problems with Cisco CallManager Extension Mobility

This section provides information for:

- [Clearing General Problems, page 6-2](#)
- [Clearing Errors in Cisco CallManager Extension Mobility, page 6-2](#)

Clearing General Problems

Start with these general troubleshooting tips if any problems occur with Cisco CRA applications:

- Check that you have thoroughly and correctly performed:
 - all the installation steps in the [“Installing Cisco CallManager Extended Services”](#) section on page 2-3
 - all the configuration procedures in the [“Configuring Cisco CallManager Extension Mobility”](#) section on page 3-1
- Try `http://hostname:8080`. Make sure that the embedded web server is running.
- Check that the port number is 8080. Remember that the default port number is 8080.
- Make sure that the URL is correct. Remember that the URL is case-sensitive.

Clearing Errors in Cisco CallManager Extension Mobility

Use the information in this section to clear problems which have error messages associated with them.

Unknown Error from Service

Action Verify that all the Cisco CallManager services are running.

Application Authentication Error

Action Perform the following tasks:

1. Check the UserID and Password of the Extension Mobility user you created in [Creating a New Application User](#), page 3-7.
2. Verify that you added the UserID and Password correctly in the [“Adding the Login Application”](#) section on page 3-10 and the [“Adding the Logout Application”](#) section on page 3-13.

Device Does Not Allow Logon

Action In the phone configuration page, make sure that “Enable Extension Mobility Feature” is selected. See the [“Subscribing to the Cisco CallManager Login Service”](#) section on page 3-32.

Device Profile Does Not Exist

Action Ensure that there is a Default Device Profile associated with the user. See [“Creating the Default Device Profile for a User”](#) section on page 3-26.

Directory Service Error

Action The LDAP Directory has a problem. There may a problem with the DirUser.jar file on the server machine.

Proxy Not Allowed

Action Make sure that the Cisco CallManager Extension Mobility user has “Authentication Proxy Rights” enabled. See the [“Creating a New Application User”](#) section on page 3-7.

Another User Logged In

Action Logout the user by selecting the Logout Service. Log back in to allow login access to the second user.

No User Logged In

Action A user is trying to select logout service when no user is logged into the phone. A user cannot log out a device which does not have anyone logged in.

Null Name for Device

Action Check that the firmware version of the phone is P00303010013 or later.

Login Server Connection Error

Action If you are running Cisco CallManager Extension Mobility on an IBM-340 platform, check that the system allows anonymous access to the Login Service web site. See the [“Setting up Anonymous Access on IBM-340 platforms” section on page 3-34](#).

Action The URL of the Login Service may not be configured properly in the LDAP directory. Check that the URL is correct. See the [“Adding the Login Application” section on page 3-10](#).

System Not Enabled

Action The service parameter to enable Cisco CallManager Extension Mobility is set to off. Make sure that, on the Service Parameters Configuration page, the Login Service Enabled field is set to **True** (to enable the user login service). See the [“Setting the Service Parameters” section on page 3-23](#).

User Logged in Elsewhere

Action The service parameter which controls multiple logins is set to allow login at a single device and a user tries to log in at a second device. If the configuration is correct, explain the login policy to the user. If the configuration is incorrect, set the Multi Login Behavior field to multiple logins allowed. Refer to [Setting the Service Parameters, page 3-23](#).

HTTP Error

Action You may not have configured the proxy settings properly for Internet Explorer on the Cisco Customer Response Application (Cisco CRA) Engine. Contact your network administrator for information on configuring the proxy settings.

Clearing Problems with Cisco CallManager AutoAttendant

This section describes how to clear the following problems that may impact Cisco CallManager AutoAttendant:

- [No Matches for an Existing User, page 6-5](#)
- [Cisco CallManager AutoAttendant Prompt is Not Found, page 6-5](#)

No Matches for an Existing User

Symptom A search fails for an existing user in the Cisco CallManager AA.

Possible Cause The user is not found because the `ccndir.ini` file is missing information or the extension is not valid because the user does not have a primary extension assigned in Cisco CallManager Administration.

Action

1. Verify that the user has an entry in the Cisco CallManager AA Name dialing field and that the User record has an associated phone and that the primary extension button is selected.
2. Verify that the `ccndir.ini` file contains the following lines:

```
USERBASE "ou=Users, o=cisco.com"  
PROFILEBASE "ou=profiles, ou=CCN, o=cisco.com"
```
3. If you migrated the Cisco CallManager from version 2.4, a possible schema issue exists. In the LDAP Directory Administration, verify that the user's Owner field is in Userid format, not full name format.

Cisco CallManager AutoAttendant Prompt is Not Found

Symptom The Cisco CallManager AA prompt is not found.

Possible Cause Media configuration was not initialized properly.

Select **Media** from the main Application Administration page and verify that the prompt directory is listed as:

```
C:\program files\cisco\wffavvid\Prompts
```

and that the User Datagram Protocol (UDP) start port is 16384.

■ Clearing Problems with Cisco CallManager Extension Mobility

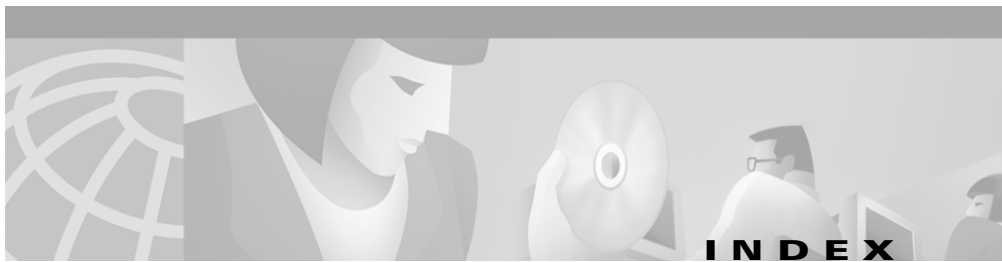

A

- application engine [1-6](#)
 - configuring [5-3](#)
 - stopping [5-2](#)
- applications, monitoring [5-8](#)

C

- Cisco CallManager [1-6](#)
 - adding CTI ports [4-3](#)
 - adding CTI route points [4-2](#)
- Cisco CallManager AutoAttendant
 - functionality [1-5](#)
 - installing [2-3](#)
 - no matches for user [6-5](#)
 - overview [1-4](#)
 - problems [6-5](#)
 - prompt not found [6-5](#)
- Cisco CallManager Extended Services [6-1](#)
 - administering [5-1](#)
 - before you install [2-1](#)
 - components [1-6](#)
 - installing [2-3](#)
- Cisco CallManager Extension Mobility
 - configuring [3-1](#)
 - configuring, rules [3-1](#)
 - installing [2-3](#)
 - overview [1-2](#)
- Cisco CRA Engine
 - adding a CTI port group [4-10](#)
 - changing engine configuration [5-3](#)
 - configuring for Cisco CallManager AutoAttendant [4-6](#)
 - configuring for Cisco CallManager Extension Mobility [3-10](#)
 - configuring the JTAPI subsystem [4-9](#)
 - starting, stopping [5-2](#)
- Cisco Customer Response Platform
 - components [1-6](#)
- configuration
 - application engine [5-3](#)
 - CTI ports in Cisco CallManager [4-3](#)
 - of directory information [4-6](#)
 - of media [4-13](#)
 - of the application server [4-6](#)
 - prompts [4-13](#)
 - trace file options [5-4](#)
 - welcome prompt [4-15](#)
- configuring Cisco CallManager AutoAttendant
 - configuring instances [4-12](#)

recording the Welcome prompt [4-14](#)

CTI ports

adding in Cisco CallManager [4-3](#)

adding to the application server [4-10](#)

CTI route points

adding in Cisco CallManager [4-2](#)

D

downloading

trace files [5-7](#)

E

Error codes

Cisco CallManager Extension Mobility [6-2](#)

G

gateways [1-6](#)

types supported [1-2](#)

I

installing

Cisco CallManager AutoAttendant [2-3](#)

Cisco CallManager Extended Services [2-3](#)

Cisco CallManager Extension Mobility [2-3](#)

real-time reporting tool [5-8](#)

J

jar files [1-6](#)

JTAPI subsystem

configuring [4-9](#)

L

LDAP directory [1-6](#)

function defined [1-6](#)

Lightweight Directory Access Protocol [1-6](#)

M

Media [6-5](#)

media configuration [4-13](#)

monitoring application activity [5-8](#)

P

printing reports [5-13](#)

prompts

configuring [4-13](#)

recording [4-14](#)

R

real-time reporting tool

installing [5-8](#)

starting [5-9](#)

repository profiles [4-7](#)

resetting statistics [5-12](#)

S

spoken name, uploading [4-16](#)

starting

 real-time reporting tool [5-9](#)

starting, application engine [5-2](#)

stopping, application engine [5-2](#)

T

trace files

 downloading [5-7](#)

 options [5-4](#)

Troubleshooting [6-1](#)

U

UDP [4-13](#)

uploading, spoken name [4-16](#)

User Datagram Protocol (UDP) [4-13](#)

V

voice gateways [1-6](#)

W

wav files [4-14](#)

Welcome prompt [4-14](#)

welcome prompt

 configuring [4-15](#)

Free Manuals Download Website

<http://myh66.com>

<http://usermanuals.us>

<http://www.somanuals.com>

<http://www.4manuals.cc>

<http://www.manual-lib.com>

<http://www.404manual.com>

<http://www.luxmanual.com>

<http://aubethermostatmanual.com>

Golf course search by state

<http://golfingnear.com>

Email search by domain

<http://emailbydomain.com>

Auto manuals search

<http://auto.somanuals.com>

TV manuals search

<http://tv.somanuals.com>