

Owner's Manual & Safety Instructions

Save This Manual Keep this manual for the safety warnings and precautions, assembly, operating, inspection, maintenance and cleaning procedures. Write the product's serial number in the back of the manual near the assembly diagram (or month and year of purchase if product has no number). Keep this manual and the receipt in a safe and dry place for future reference.

ITEM 69488

PACIFICHYDROSTAR®

1650 PSI ELECTRIC PRESSURE WASHER



Visit our website at: <http://www.harborfreight.com>
Email our technical support at: tech@harborfreight.com

When unpacking, make sure that the product is intact and undamaged. If any parts are missing or broken, please call 1-800-444-3353 as soon as possible.

Copyright© 2011 by Harbor Freight Tools®. All rights reserved. No portion of this manual or any artwork contained herein may be reproduced in any shape or form without the express written consent of Harbor Freight Tools. Diagrams within this manual may not be drawn proportionally. Due to continuing improvements, actual product may differ slightly from the product described herein. Tools required for assembly and service may not be included.

⚠ WARNING

**Read this material before using this product.
Failure to do so can result in serious injury.
SAVE THIS MANUAL.**

Table of Contents

Safety	3	Maintenance	14
Setup	7	Parts Lists and Assembly Diagrams	16
Specifications	7	Warranty	20
Operation.....	10		



WARNING SYMBOLS AND DEFINITIONS

	This is the safety alert symbol. It is used to alert you to potential personal injury hazards. Obey all safety messages that follow this symbol to avoid possible injury or death.
	Indicates a hazardous situation which, if not avoided, will result in death or serious injury.
	Indicates a hazardous situation which, if not avoided, could result in death or serious injury.
	Indicates a hazardous situation which, if not avoided, could result in minor or moderate injury.
	Addresses practices not related to personal injury.

SAFETY

SETUP

OPERATION

MAINTENANCE

IMPORTANT SAFETY INSTRUCTIONS



WARNING When using this product basic precautions should always be followed, including the following:

Safety Warnings

1. Read all the instructions before using the product.
2. To reduce the risk of injury, close supervision is necessary when a product is used near children.
3. Know how to stop the product and bleed pressures quickly. Be thoroughly familiar with the controls.
4. Stay alert – watch what you are doing.
5. Do not operate the product when fatigued or under the influence of medication, alcohol or drugs.
6. Keep operating area clear of all persons.
7. Do not overreach or stand on unstable support. Keep good footing and balance at all times.
8. Follow the maintenance instructions specified in the manual.
9. This product is provided with a Ground Fault Circuit Interrupter (GFCI) built into the power cord plug. If replacement of the plug or cord is needed, use only identical replacement parts.
10. **WARNING** – Risk of injection or injury—do not direct discharge stream at persons.
11. Connect to individual branch circuit only.
12. **WARNING** – To reduce the risk of electrocution, keep all connections dry and off the ground. Do not touch plug with wet hands.
13. Do not abuse the cord. Never use the cord for carrying, pulling or unplugging the pressure washer. Keep cord away from heat, oil, sharp edges or moving parts. Damaged or entangled cords increase the risk of electric shock.
14. **GFCI PRECAUTIONS**
Test GFCI (Ground Fault Circuit Interrupter) before each use as follows:
 - a. Plug GFCI into power outlet and press reset button. Indicator should turn on.
 - b. Press test button. Indicator should turn off.
 - c. Press reset button again for use.

Do not use if above test fails.

The GFCI device does not protect against electrical shock due to contact with both circuit conductors or a fault in any wiring supplying the GFCI device.
To allow GFCI unit to function properly, EXTENSION CORDS MUST NOT BE USED with this pressure washer.

Set up Precautions

1. The work area should have adequate drainage to reduce the possibility of a fall or electric shock due to wet surfaces.
2. Wear ANSI-approved safety goggles during set up and use.
3. Only feed cold, clean water through this tool. Pressure washer detergent may be used in the soap dispenser only. Do not use caustic materials, solvents, flammable materials, or detergents not designed for pressure washers. Use of any such material can cause injury, or damage this tool or personal property.
4. Prior to starting the Pressure Washer in cold weather, check all of the parts of the unit to make sure ice has not formed. Do not store the unit anywhere that the temperature will fall near 32° F (0° C).

Operating Precautions

SAFETY

SETUP

OPERATION

MAINTENANCE

1. Disconnect the plug from the power source before making any adjustments, changing accessories, or storing pressure washers. Such preventive safety measures reduce the risk of starting the pressure washer accidentally.
2. Do not leave the equipment unattended when it is running. Turn off the equipment before leaving the work area.
3. Wear ANSI-approved safety goggles and heavy-duty nonslip rubber work boots during use.
4. Use only accessories that are recommended by Harbor Freight Tools for your model. Accessories that may be suitable for one piece of equipment may become hazardous when used on another one.
5. This product must continuously run with cold water only. Never use hot water. Do not dry run this product. Dry running will cause serious damage to the seals.
6. To avoid electrical shock, never start and run the Pressure Washer in the rain. Never allow water to leak into the Body of the Pressure Washer. Do not direct discharge stream at the Pressure Washer itself or at other live electrical equipment.
7. Do not allow the GFCI Plug to become wet. Always place the GFCI Plug in a dry location and as far away as possible from the object being sprayed.
8. DO NOT use an extension cord with this product.
9. When using the Pressure Washer, always maintain a firm grip on the Spray Gun. Squeezing the Trigger of the Spray Gun causes a kickback force.
10. Do not feed already-pressurized water (such as that from another pressure washer) into this washer.
11. People with pacemakers should consult their physician(s) before use. Electromagnetic fields in close proximity to heart pacemaker could cause pacemaker interference or pacemaker failure.
12. **WARNING:** The brass components of this product contain lead, a chemical known to the State of California to cause birth defects (or other reproductive harm). (California Health & Safety code § 25249.5, *et seq.*)
13. **WARNING:** Handling the cord on this product will expose you to lead, a chemical known to the State of California to cause cancer, and birth defects or other reproductive harm. Wash hands after handling. (California Health & Safety Code § 25249.5, *et seq.*)
14. Use the correct equipment for the application. Do not modify the equipment and do not use the equipment for a purpose for which it is not intended.
15. If water is leaking out of the Pressure Washer immediately turn off the unit. Unplug the Pressure Washer, and discharge all pressure before tightening fittings or having repair work done by a qualified technician.
16. The high pressure water flow can damage the work surface if not used properly. Always test the spray in an open area first.
17.  **Injection Hazard.** The high pressure water jet produced by this tool can cut skin or cause injury to hands or eyes. Do not allow spray to strike you and do not spray toward people or animals. Do not spray the tool itself or any electrical source.
18. This Pressure Washer is intended for outdoor residential use only.
19. **In case of an emergency during use, immediately release the trigger on the spray handle, turn the power switch off and then unplug the unit. Do not set the spray handle down without turning off the power switch.**

Vibration Hazard:

This tool vibrates during use. Repeated or long-term exposure to vibration may cause temporary or permanent physical injury, particularly to the hands, arms and shoulders. To reduce the risk of vibration-related injury:

1. Anyone using vibrating tools regularly or for an extended period should first be examined by a doctor and then have regular medical check-ups to ensure medical problems are not being caused or worsened from use. Pregnant women or people who have impaired blood circulation to the hand, past hand injuries, nervous system disorders, diabetes, or Raynaud's Disease should not use this tool. If you feel any medical or physical symptoms related to vibration (such as tingling, numbness, and white or blue fingers), seek medical advice as soon as possible.
2. Do not smoke during use. Nicotine reduces the blood supply to the hands and fingers, increasing the risk of vibration-related injury.
3. Wear suitable gloves to reduce the vibration effects on the user.
4. Use tools with the lowest vibration when there is a choice between different processes.
5. Include vibration-free periods each day of work.
6. To reduce vibration, maintain the tool as explained in this manual. If any abnormal vibration occurs, stop use immediately.

Service Precautions









Ground Fault Circuit Interrupter Protection

This pressure washer is provided with a ground-fault circuit-interrupter (GFCI) built into the plug of the power-supply cord. This device provides additional protection from the risk of electric shock. Should replacement of the plug or cord become necessary, use only identical replacement parts that include GFCI protection.

Servicing a Double-Insulated Appliance

In a double-insulated product, two systems of insulation are provided instead of grounding. No grounding means is provided on a double-insulated product, nor should a means for grounding be added to the product. Servicing a double-insulated product requires extreme care and knowledge of the system, and should be done only by qualified service personnel. Replacement parts for a double-insulated product must be identical to the parts they replace. A double-insulated product is marked with the words "DOUBLE INSULATION" or "DOUBLE INSULATED." The symbol  may also be marked on the product.

Symbology

	Double Insulated		WARNING marking concerning Risk of Eye Injury. Wear ANSI-approved safety goggles with side shields.
	Canadian Standards Association		Read the manual before set-up and/or use.
	Interlink Testing Services		WARNING marking concerning Risk of Electric Shock. Properly connect power cord to appropriate outlet.
	Volts Alternating Current		WARNING marking concerning Risk of Injection. Do not direct spray at any person or animal.
	Amperes		



SAVE THESE INSTRUCTIONS.

 **PACIFICHYDROSTAR**®

Specifications

Electrical Rating	120V~ / 60Hz / 13A
Maximum Pressure	1650 PSI
Maximum Flow Rate	1.25 GPM
High Pressure Hose	13-3/4 FT.
Power Cord	35 ft.

Setup – Before Use:



Read the **ENTIRE IMPORTANT SAFETY INFORMATION** section at the beginning of this manual including all text under subheadings therein before set up or use of this product.

⚠ WARNING

TO PREVENT SERIOUS INJURY FROM ACCIDENTAL OPERATION:

Turn the Power Switch of the tool off, unplug the tool from its electrical outlet, shut off the water supply and safely discharge all residual water pressure from the unit before assembling or making any adjustments to the tool.

Components

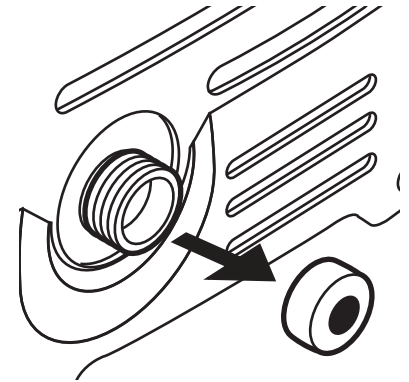

Figure A

Assembly

Note: For additional information regarding the parts listed in the following pages, refer to *Parts Lists and Assembly Diagrams* on page 16. Some of the following assembly steps may have been performed at the factory.

1. Check the Inlet Strainer for any blockage, including packaging debris. Remove any plastic plugs from the water inlet/outlet.



2. Attach the Gun/Extension Nozzle holder to the side of the body.

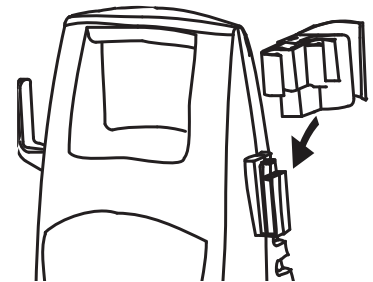

3. Attach the Handle to the front of the Body with the four included Screws.

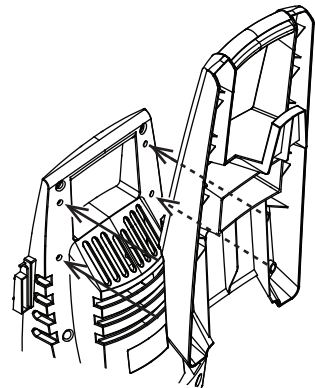

4. Thread the High Pressure Hose onto the Pressure Hose Outlet on the back of the body.

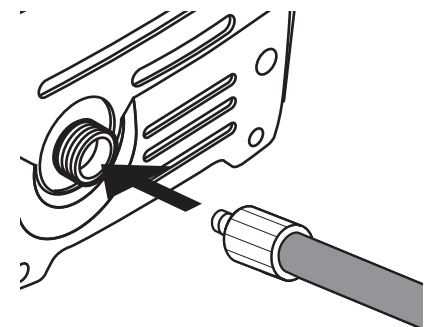

5. Thread the High Pressure Hose to the Spray Gun.

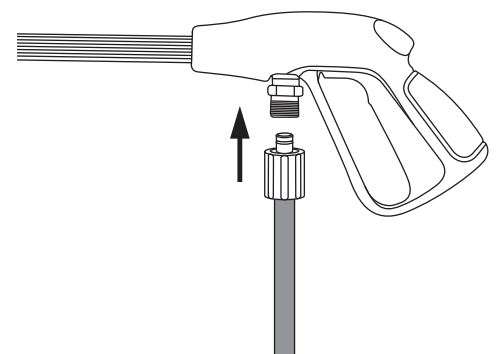

Features

Note: Familiarize yourself with the location and function of all of the machine's controls before proceeding to setup of the machine.

1. This item is equipped with a GFCI (Ground Fault Circuit Interruption) plug. Read and follow these GFCI precautions: **WARNING! TO PREVENT ELECTRIC SHOCK AND DEATH:** Test GFCI (Ground Fault Circuit Interrupter) before each use as follows:

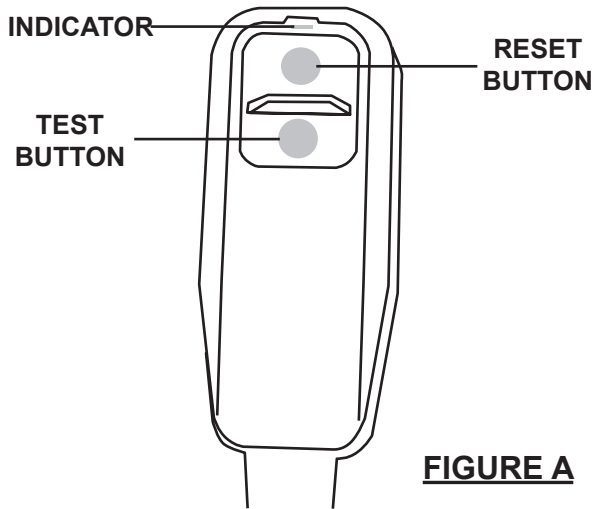

FIGURE A

The GFCI device does not protect against electrical shock due to contact with both circuit conductors or a fault in any wiring supplying this device.

Should replacement of the GFCI Power Plug become necessary, only a qualified technician should perform the service.

Do not alter or disable the GFCI Power Plug.

To allow the GFCI unit to function properly, extension cords must not be used with this pressure washer.

2. The Spray Control Sleeve on the Spray Wand can be rotated for a range of spray patterns, from a full fan spray to a direct stream spray.

- a. Make sure the trigger is released and plug GFCI into power outlet. Press reset button. Indicator should turn on.
- b. Press test button. Indicator should turn off.
- c. Press reset button again for use. Do not use if above test fails.

Operating Instructions



Read the **ENTIRE IMPORTANT SAFETY INFORMATION** section at the beginning of this manual including all text under subheadings therein before set up or use of this product.

Work Piece and Work Area Set Up

1. Designate a work area that is clean and well-lit. The work area must not allow access by children or pets to prevent distraction and injury.
2. **CHECK THE WATER SUPPLY.** Prior to using the Pressure Washer for the first time, it is **ESSENTIAL** to verify that the water supply is adequate. The Pressure Washer needs **TWICE** the water supply (or volume) than the listed water output (1.3 GPM). This Pressure Washer will need about 2.6-3 GPM to operate correctly and efficiently. If the water is being supplied by a well/pump, make certain that the well/pump produces enough water to keep up with the Pressure Washer's water demands. Water supply hoses should be heavy duty to withstand the forces involved. Water hoses up to 25' long must be $\frac{5}{8}$ " ID. Water hoses up to 50' long must be $\frac{3}{4}$ " ID. Do not use hoses longer than 50'. The more minerals in the water (the harder the water) you use, the more often mineral buildup will need to be cleaned out from the nozzles. The flow rate of the water supply must never be allowed to fall below 2.6 GPM.
To determine the water supply's flow rate: Run the water at full for one minute into a 5 gallon container, and measure the amount of water in the container. **CAUTION!** If the Pressure Washer is run with an inadequate water supply, the pump will cavitate. Cavitation causes the pump to operate loudly and will damage it.
3. **ARRANGE FOR A PROPER ELECTRICAL SUPPLY.** This unit uses a large amount of current, especially during start-up. Turn off power switch, then connect this unit only to a dedicated household circuit capable of providing ample current to it. A dedicated circuit has no additional loads (running devices) connected to it; shut off any appliances that slow down or lights that dim while the washer is running. For best results, connect the plug to that circuit's outlet that is nearest to the circuit breaker panel.
4. **PLAN OUT THE JOB:** Plan out what areas will be cleaned, how many sessions will be necessary, and how long the individual sessions of work will need to be. Plan to clean the higher portions first, because the higher portions will typically remain cleaner while the other areas are cleaned. Plan a safe direction for runoff to flow while the job is being performed, and plan on working your way in that direction. You will have a clearer idea of the time involved to clean the area after doing a test run.
5. Clear the cleaning area of all objects that are not being cleaned. If any water prone or delicate items cannot be moved, protect them. If detergent is to be used, cover or remove any plants or animals that may be damaged by the detergent. Disconnect power to and protect any nearby electrical wiring from water and spray.
6. Place the Pressure Washer in a location which is protected from any water from the cleaning area. Select a location higher than the cleaning area. The pressure washer's location should be close enough so that the hose will reach every portion of the job to be done with some slack for movement. Also, select an area with proper access to a dedicated circuit.
7. Route the power cord along a safe route to reach the work area without creating a tripping hazard or exposing the power cord to possible damage. The power cord must reach the work area with enough extra length to allow free movement while working.



Tool Set Up

⚠️ WARNING

TO PREVENT SERIOUS INJURY FROM ACCIDENTAL OPERATION:

Turn the Power Switch of the pressure washer off, unplug it from its electrical outlet, and relieve all pressure in a safe manner before making adjustments or installing accessories.

1. MAKE SURE THE WASHER IS CLEAN AND READY FOR USE. Ensure the inlet water strainer, nozzle, and the rest of the Washer are completely free of buildup or debris.
2. If using the Extension Nozzle, insert it into the end of the gun, pressing in and twisting, until it clicks into place.

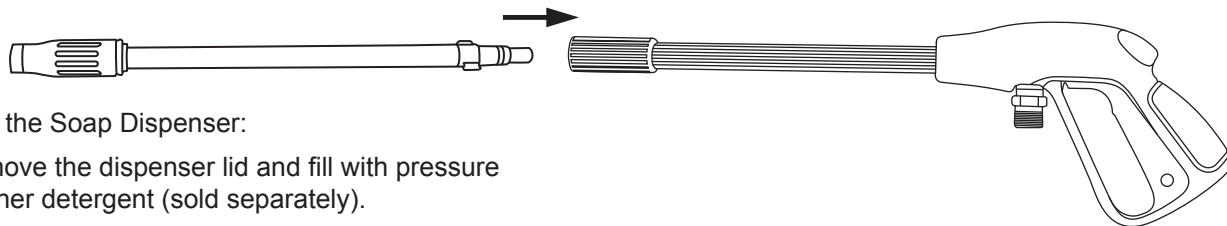

If using the Soap Dispenser:

- a. Remove the dispenser lid and fill with pressure washer detergent (sold separately).
- b. Set the spray to the fan setting by turning the end of the Extension Nozzle counterclockwise.

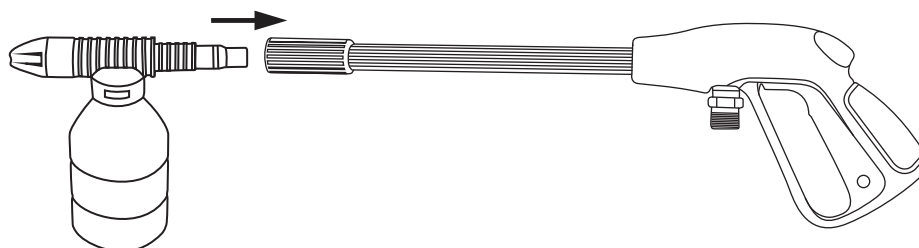

- c. Insert the Extension Nozzle into the Dispenser cap, pressing and twisting, until it clicks into place (shown at right).

3. Before connecting the water supply, run water through the garden hose (sold separately) to remove any debris.

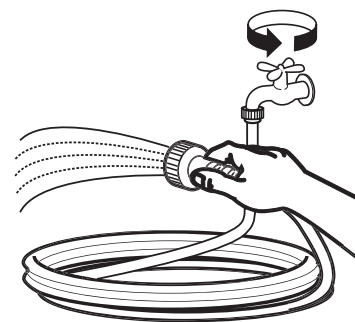

4. Turn off the water, then thread the garden hose onto the Water Supply Inlet on the front of the Pressure Washer.

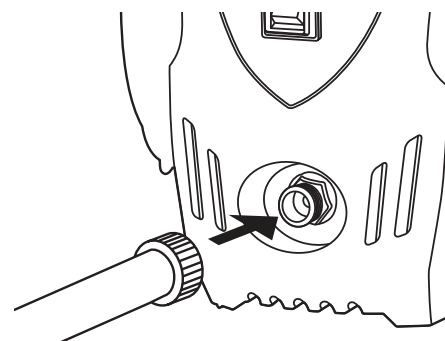

5. Plug the Power Cord into a power outlet and test the GFCI by pressing the Reset Button, then the Test button, then the Reset Button again, as described in Controls and Features section.

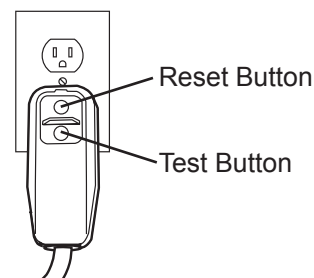

Note: The Pressure Washer will not work if the GFCI is not properly reset.

General Operating Instructions

SAFETY

1. Point the Nozzle in a safe direction. Press in the Safety Lock Button to unlock the Trigger and squeeze the Trigger to check that all pressure is released from the unit. Release the Trigger.

Note: The Gun's safety lock feature locks the Trigger when not in use. To unlock the unit and use the gun, press the Safety Lock Button and squeeze the Trigger. The safety lock will re-engage when you release the Trigger.

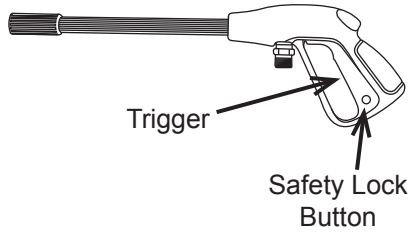

SETUP

2. Turn on the water supply.

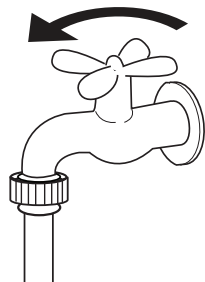

OPERATION

3. Turn on the Power Switch.

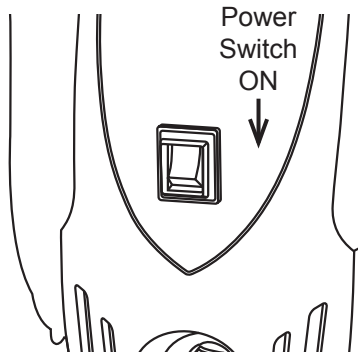

MAINTENANCE

Note: If the unit does not turn on or turns off suddenly, check and reset the GFCI.

4. Unlock the Safety Lock Button and squeeze the Trigger to start the stream. Be aware that when it is first started, the gun will kick back.
5. Test spray the edge of the surface to be cleaned to make sure that the stream is not too strong for the surface. Adjust the pressure by squeezing the Trigger more or less, and by changing your distance from the surface. Adjust the stream from a fan to a direct stream by turning the nozzle.
6. When finished using the Pressure Washer, release the Trigger, turn the Power Switch off, unplug the unit, and turn off the water supply.
7. Point the Nozzle in a safe direction and press the Safety Lock Button and squeeze the trigger to check that all pressure is released from the unit. Release the Trigger.
8. Clean, then store indoors, out of children's reach.



Operating Tips

Become Familiar With your Machine:

1. Before beginning work, set aside enough time to familiarize yourself with this machine's cleaning rate and capacity along with all instructions and precautions contained in this section, along with the Operating Instruction and Controls and Features sections.
2. This unit is intended for various light to moderate cleaning applications. If deeper cleaning is desired, it can be attained at times, however this is done at the expense of speed. This unit is not intended for paint stripping or deep concrete cleaning applications.
3. Clean a test area to satisfaction before proceeding with the entire area, as stated in Cleaning Recommendations.
4. This unit has several settings and adjustments that effect the speed of cleaning and the water force applied to cleaning. Good guidelines to keep in mind are:

WIDE STREAM =
QUICKER COVERAGE BUT
LIGHTER CLEANING.

NARROW STREAM =
DEEPER CLEANING BUT
SLOWER COVERAGE.

Cleaning Recommendations

5. Clean an inconspicuous test area first. Always begin with the fan spray at a distance of about 3-5 feet from the surface being cleaned to avoid damaging it. Clear the test area of people and water-sensitive objects. If a pressure washing detergent is to be used, apply the detergent to this area as well. After cleaning this area, switch off the pressure washer and inspect the area carefully for any damage or discoloration. If any damage is noted from the pressure setting, use a lighter setting when cleaning the rest of the area. If damage or discoloration is noted from the detergent, do not use it when cleaning.
 6. First, pass over the area with a light cleaning, and then more thoroughly clean it.
7. If detergent is to be applied: Only use pressure washing detergent in the soap dispenser; other detergents will clog the dispenser. Do not add detergent to the body of the pressure washer. Spray the surface with detergent until evenly covered, then turn off the machine and water source, release pressure, and remove the soap dispenser. Allow the detergent several minutes to sit and soak into the work surface; this will improve cleaning efficiency. Turn on the water source and power, and rinse off all detergent completely.
 8. Hold the Spray Gun at about a 45° angle and steadily sweep the stream back and forth; if a severe, head-on angle is used, dirt may imbed in the surface being cleaned. Follow a steady, consistent pace during cleaning; this will help prevent stripes or discoloration afterwards. If streaking or uneven cleaning is noted at the end of a project, go over the edges of the streaks with a wide fan pattern to help blend these lighter areas in.
 9. If several different surfaces are to be cleaned, be careful not to damage any of the less solid surfaces while trying to clean the harder ones. This is especially a concern when cleaning tile and grout, bricks and mortar, or stones and mortar.
 10. If wood is being cleaned, be careful to avoid damage. Wood will usually require resurfacing (sanding) and re-coat with a surface protectant (wood, stain, varnish) after it has dried. Try to avoid leaving water on a wooden surface; doing so can harm the surface.

For a *vertical or sloped* surface:

- a. Wash from the top down.
- b. If possible, direct the stream in the same direction as the slope towards a draining area. This will enable better drainage and therefore better cleaning.

For a *flat* surface:

- a. If a thin layer of water accumulates on the surface, periodically use the stream to direct this water towards the drainage.
- b. After the major cleaning is done, sweep the surface with the stream to help direct loose debris toward the drainage.

⚠️WARNING

TO PREVENT SERIOUS INJURY FROM ACCIDENTAL OPERATION:

Turn the Power Switch of the tool off, unplug the tool from its electrical outlet, shut off the water supply and safely discharge all residual water pressure from the unit before performing any inspection, maintenance, or cleaning procedures.

TO PREVENT SERIOUS INJURY FROM TOOL FAILURE:

Do not use damaged equipment. If abnormal noise or vibration occurs, have the problem corrected before further use.

Cleaning, Maintenance, and Lubrication

- 1. Before each use**, inspect the general condition of the Pressure Washer. Check for loose screws, misalignment or binding of moving parts, damaged electrical wiring, damaged High Pressure Hose, damaged accessories, and any other condition that may affect its safe operation. If abnormal noise or vibration occurs, have the problem corrected before further use. **Do not use damaged equipment.**
- 2. To clean**, remove excess water from the Pump by tipping the unit to drain any remaining water from the inlet and outlet fittings. Drain the Detergent Dispenser and flush with running water. Use only a clean cloth and mild detergent to clean the body of the Pressure Washer. Do not use solvents. **Do not immerse any part of the tool in liquid.** Dry off any remaining water on all parts and fittings. Remove mineral deposits from the nozzle using a thin, stiff wire brush. The more minerals that are dissolved in the water (the harder the water) you use, the more often mineral buildup will need to be cleaned out from inside nozzle.
- 3.** In areas that have hard water (water rich in minerals such as calcium) the unit will need to be cleaned periodically to remove calcium buildup which can clog the system. **To clean off calcium buildup:** Unplug the unit and lay it face down. Fill the body at the water inlet fitting with calcium remover and allow at least 5 hrs. for calcium deposit to break down. Rinse and dry.
- 4. STORAGE:** When storing, empty the Pressure Washer of water. Frost will damage the Pressure Washer if the unit contains water. Store the Pressure Washer in a dry, frost-free room. Flush the unit with automotive antifreeze prior to long-term storage. Dispose of antifreeze according to local ordinances.
- 5. ⚠️WARNING!** If the supply cord or GFCI unit of this power tool is damaged, it must be replaced only by a qualified service technician.

Note: Pump gearbox oil type is SAE 15W/40 gr. 70.

Troubleshooting

Problem	Possible Causes	Likely Solutions
Pressure Washer will not start	<ol style="list-style-type: none"> 1. Cord not connected. 2. No power at outlet. 3. GFCI circuit breaker tripped. 4. Internal damage or wear. (Carbon brushes or switch, for example.) 	<ol style="list-style-type: none"> 1. Check that cord is plugged in. 2. Check power at outlet. If outlet is unpowered, turn off tool and check circuit breaker. If breaker is tripped, make sure circuit is right capacity for tool and circuit has no other loads. 3. Press reset button on GFCI unit on cord. 4. Have a qualified technician service tool.
Pressure Washer stops suddenly	<ol style="list-style-type: none"> 1. GFCI circuit breaker tripped. 2. Water leaking from housing. 	<ol style="list-style-type: none"> 1. Press reset button on GFCI unit on cord. 2. SHOCK HAZARD! IMMEDIATELY discontinue use. Have the unit repaired by a qualified technician before further use.
Output pressure varies	<ol style="list-style-type: none"> 1. Not enough water supply. 2. Air in water supply. 3. Water Inlet Filter is clogged. 4. Extension Nozzle not attached to Spray Gun. 5. Nozzle is clogged. 6. Nozzle has mineral build up. 7. Garden hose is too long. 8. Internal valves or seals may be worn or sticking. 	<ol style="list-style-type: none"> 1. Check water supply hose for kinks, leaks, or blockage. Open faucet all the way. 2. Check that all connections are tight. 3. Remove Filter and clean. 4. Pressure is created by the Nozzle, not the Spray Gun. Attach Extension Nozzle to unit. 5. Remove Nozzle and clean. 6. Remove Nozzle and clean with vinegar. 7. Recommended garden hose length is 20 to 50 feet, or 30 feet if using well water. Shorten the length of the garden hose if needed to increase pressure. 8. Have a qualified technician service tool.
Trigger does not depress	Safety lock is still engaged.	Press in on the release button on the bottom of the Spray Gun Handle to release the Safety Lock.
Detergent will not dispense	Incorrect detergent type.	Check that the detergent is the recommended type of detergent. Clean out dispenser and replace with correct type if needed.
Performance decreases over time	Clogged with mineral deposits.	Clean unit with a de-mineralizing solution such as vinegar or other aqueous acidic cleaner.
 Follow all safety precautions whenever diagnosing or servicing the tool. Disconnect power supply before service.		

Pump Assembly Parts List

Part	Description	Qty
1	Outlet	1
2	Spring	1
3	O-Ring	1
4	Sleeve	1
5	O-Ring	1
6	Valve Core	1
7	Valve Core Spring	1
8	Jacket	1
9	O-Ring	1
10	O-Ring	1
11	Piston	1
12	Piston Spring	1
13	Piston Seat	1
14	O-Ring	1
15	O-Ring	1
16	Valve Seat	1
17	Pump Head	1
18	Capscrew	1
19	Spring Washer	3
20	Capscrew	1
21	O-Ring	1
22	Inlet	1
23	Strainer	1
24	Pressure Switch Push Rod	1
25	Push Rod Spring	1
26	Connecting Nut Gasket	1
27	Y-Ring	1
28	O-Ring	1
29	Connecting Nut	1
30	Pressure Switch Cover	1
31	Microswitch	1

Part	Description	Qty
32	Capscrew	4
33	Spring Washer	4
34	Pump Body	1
35	O-Ring	6
36	O-Ring	6
37	Valve Seat	6
38	Valve Core	6
39	Valve	6
40	Valve Spring	6
41	O-Ring	6
42	Valve Cap	6
43	Y-Ring	3
44	O-Ring	3
45	Middle Set	3
46	O-Ring	3
47	In The Interval Set	3
48	Skeleton Seal	3
49	Plunger Spring	3
50	Plunger	3
51	Plunger Clip	3
52	Bearing	1
53	Capscrew	1
54	Bearing Seat	1
55	Bearing	1
56	Reinforced Seal	1
57	Connecting Seat	1
58	Gear Shaft	1
59	Gear	1
60	Bearing	1
61	O-Ring	1
62	Motor	1

SAFETY

SETUP

OPERATION

MAINTENANCE

Pump Assembly Diagram

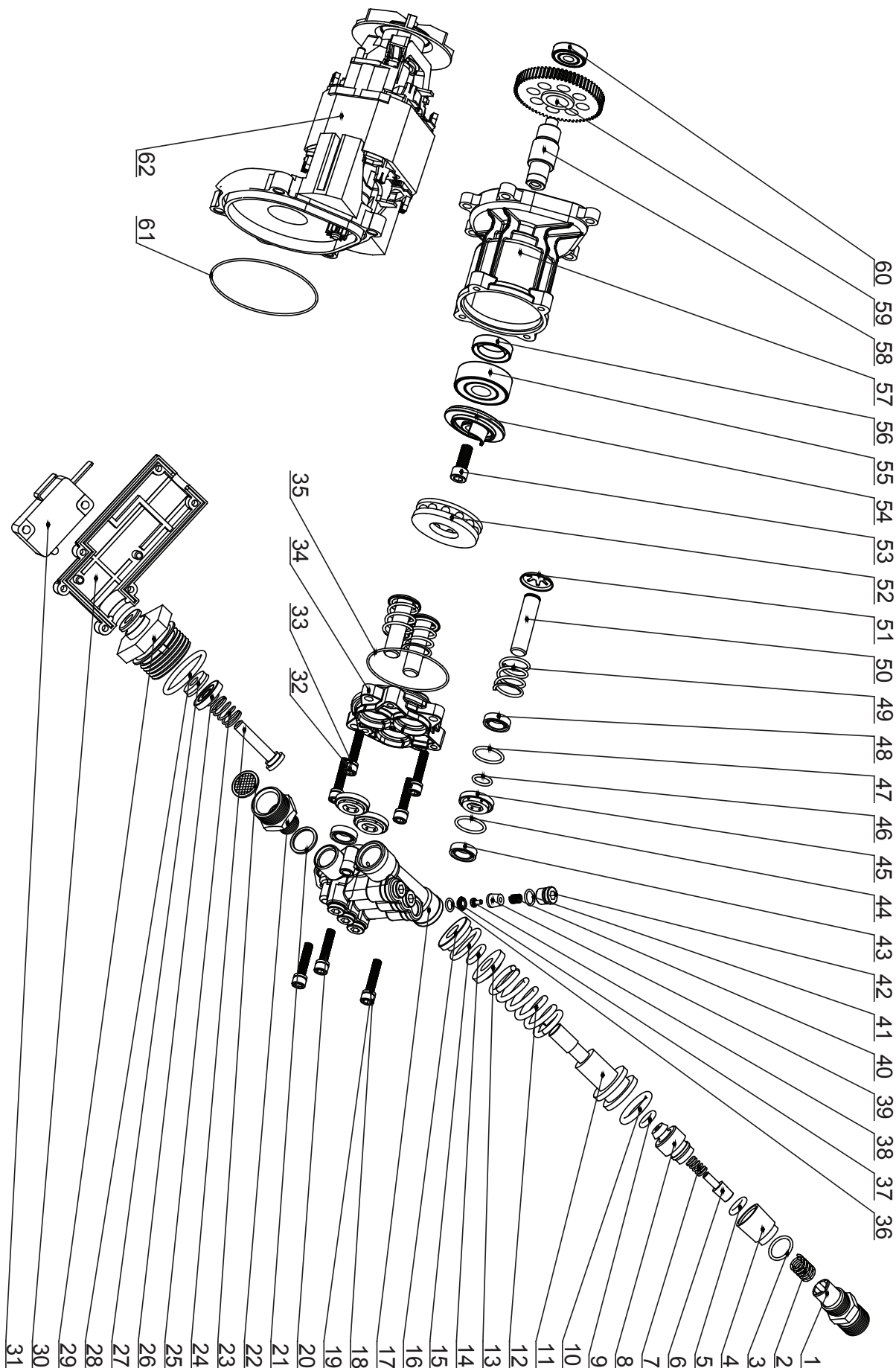

SAFETY

SETUP

OPERATION

MAINTENANCE

Pressure Washer Parts List and Assembly Diagram

SAFETY

Part	Description	Qty
1a	Power Switch Cover	1
2a	Power Switch	1
3a	Front Panel	1
4a	Upper Housing	1
5a	Waterproof Cover	1
6a	Right Motor Cover	1
7a	Cord Protector	1
8a	Cord Clamp	1
9a	Handle Extension	1
10a	Bottom Housing	1
11a	Wheel Cover	2
12a	Axle	1

Part	Description	Qty
13a	Wheel	1
14a	Heat Guard	1
15a	Fan Cover	1
16a	Pump Asm.	1
17a	Left Motor Cover	1
18a	Cushion	1
19a	Gun/Extension Nozzle Holder	1
20a	Upper Heat Guard	1
21a	Gun	1
22a	Extension Nozzle	1
23a	High Pressure Hose (not shown)	1
24a	Detergent Bottle	1

SETUP

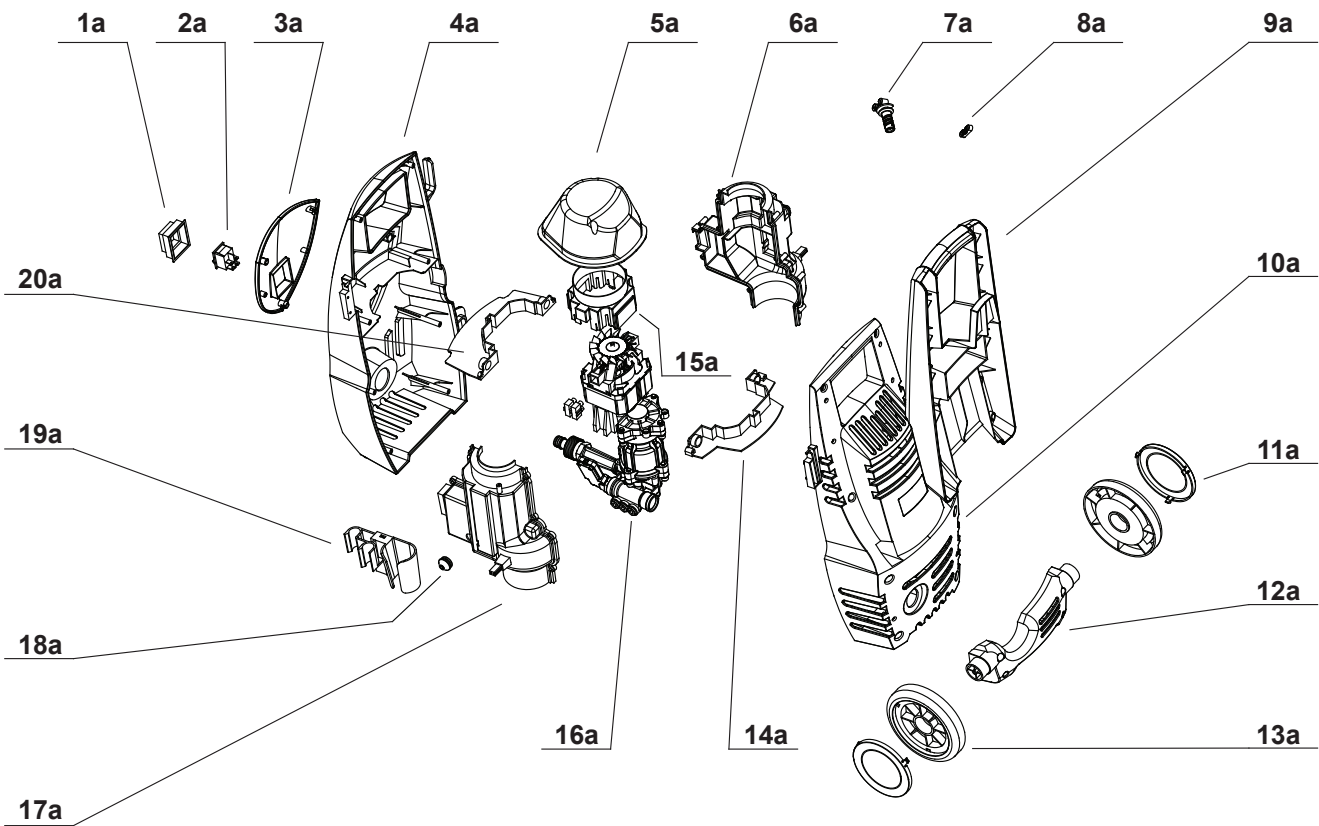

OPERATION

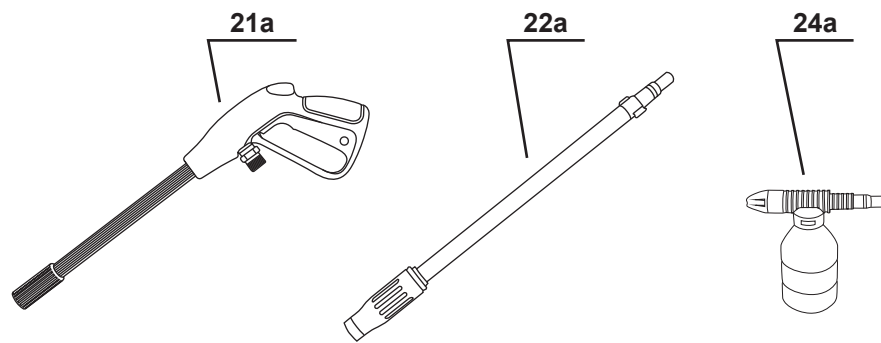

MAINTENANCE

PLEASE READ THE FOLLOWING CAREFULLY

THE MANUFACTURER AND/OR DISTRIBUTOR HAS PROVIDED THE PARTS LIST AND ASSEMBLY DIAGRAM IN THIS MANUAL AS A REFERENCE TOOL ONLY. NEITHER THE MANUFACTURER OR DISTRIBUTOR MAKES ANY REPRESENTATION OR WARRANTY OF ANY KIND TO THE BUYER THAT HE OR SHE IS QUALIFIED TO MAKE ANY REPAIRS TO THE PRODUCT, OR THAT HE OR SHE IS QUALIFIED TO REPLACE ANY PARTS OF THE PRODUCT. IN FACT, THE MANUFACTURER AND/OR DISTRIBUTOR EXPRESSLY STATES THAT ALL REPAIRS AND PARTS REPLACEMENTS SHOULD BE UNDERTAKEN BY CERTIFIED AND LICENSED TECHNICIANS, AND NOT BY THE BUYER. THE BUYER ASSUMES ALL RISK AND LIABILITY ARISING OUT OF HIS OR HER REPAIRS TO THE ORIGINAL PRODUCT OR REPLACEMENT PARTS THERETO, OR ARISING OUT OF HIS OR HER INSTALLATION OF REPLACEMENT PARTS THERETO.

Record Product's Serial Number Here: _____

Note: If product has no serial number, record month and year of purchase instead.

Note: Some parts are listed and shown for illustration purposes only, and are not available individually as replacement parts.

Limited 90 Day Warranty

Harbor Freight Tools Co. makes every effort to assure that its products meet high quality and durability standards, and warrants to the original purchaser that this product is free from defects in materials and workmanship for the period of 90 days from the date of purchase. This warranty does not apply to damage due directly or indirectly, to misuse, abuse, negligence or accidents, repairs or alterations outside our facilities, criminal activity, improper installation, normal wear and tear, or to lack of maintenance. We shall in no event be liable for death, injuries to persons or property, or for incidental, contingent, special or consequential damages arising from the use of our product. Some states do not allow the exclusion or limitation of incidental or consequential damages, so the above limitation of exclusion may not apply to you. THIS WARRANTY IS EXPRESSLY IN LIEU OF ALL OTHER WARRANTIES, EXPRESS OR IMPLIED, INCLUDING THE WARRANTIES OF MERCHANTABILITY AND FITNESS.

To take advantage of this warranty, the product or part must be returned to us with transportation charges prepaid. Proof of purchase date and an explanation of the complaint must accompany the merchandise. If our inspection verifies the defect, we will either repair or replace the product at our election or we may elect to refund the purchase price if we cannot readily and quickly provide you with a replacement. We will return repaired products at our expense, but if we determine there is no defect, or that the defect resulted from causes not within the scope of our warranty, then you must bear the cost of returning the product.

This warranty gives you specific legal rights and you may also have other rights which vary from state to state.



Free Manuals Download Website

<http://myh66.com>

<http://usermanuals.us>

<http://www.somanuals.com>

<http://www.4manuals.cc>

<http://www.manual-lib.com>

<http://www.404manual.com>

<http://www.luxmanual.com>

<http://aubethermostatmanual.com>

Golf course search by state

<http://golfingnear.com>

Email search by domain

<http://emailbydomain.com>

Auto manuals search

<http://auto.somanuals.com>

TV manuals search

<http://tv.somanuals.com>