

Anritsu

Site Master S113C, S114C, S331C, S332C, Antenna, Cable and Spectrum Analyzer

User's Guide



Hand-Held Tester for Transmission Lines
and other RF Components

WARRANTY

The Anritsu product(s) listed on the title page is (are) warranted against defects in materials and workmanship for one year from the date of shipment. Anritsu's obligation covers repairing or replacing products which prove to be defective during the warranty period. Buyers shall prepay transportation charges for equipment returned to Anritsu for warranty repairs. Obligation is limited to the original purchaser. Anritsu is not liable for consequential damages.

LIMITATION OF WARRANTY

The foregoing warranty does not apply to Anritsu connectors that have failed due to normal wear. Also, the warranty does not apply to defects resulting from improper or inadequate maintenance by the Buyer, unauthorized modification or misuse, or operation outside the environmental specifications of the product. No other warranty is expressed or implied, and the remedies provided herein are the Buyer's sole and exclusive remedies.

TRADEMARK ACKNOWLEDGMENTS

MS-DOS, Windows, Windows 95, Windows NT, Windows 98, Windows 2000 and Windows ME are registered trademarks of the Microsoft Corporation. Anritsu and Site Master are trademarks of Anritsu Company.

NOTICE

Anritsu Company has prepared this manual for use by Anritsu Company personnel and customers as a guide for the proper installation, operation and maintenance of Anritsu Company equipment and computer programs. The drawings, specifications, and information contained herein are the property of Anritsu Company, and any unauthorized use or disclosure of these drawings, specifications, and information is prohibited; they shall not be reproduced, copied, or used in whole or in part as the basis for manufacture or sale of the equipment or software programs without the prior written consent of Anritsu Company.

DECLARATION OF CONFORMITY

Manufacturer's Name: ANRITSU COMPANY

Manufacturer's Address: Microwave Measurements Division
490 Jarvis Drive
Morgan Hill, CA 95037-2809
USA

declares that the product specified below:

Product Name: Site Master

Model Number: S113C, S331C, S114C, S332C, S251C

conforms to the requirement of:

EMC Directive 89/336/EEC as amended by Council Directive 92/31/EEC & 93/68/EEC
Low Voltage Directive 73/23/EEC as amended by Council directive 93/68/EEC

Electromagnetic Interference:

Emissions: CISPR 11:1990/EN55011: 1991 Group 1 Class A
EN 61000-3-2:1995 Class A
EN 61000-3-3:1995 Class A

Immunity: EN 61000-4-2:1995/EN50082-1: 1997 - 4kV CD, 8kV AD
EN 61000-4-3:1997/EN50082-1: 1997 - 3V/m
ENV 50204/EN50082-1: 1997 - 3V/m
EN 61000-4-4:1995/EN50082-1: 1997 - 0.5kV SL, 1kV PL
EN 61000-4-5:1995/EN50082-1: 1997 - 1kV L-L, 2kV L-E
EN 61000-4-6:1994/EN61326: 1998 - 3V
EN 61000-4-8:1994/EN61326: 1998 - 3A/m
EN 61000-4-11:1994/EN61326: 1998 - 1 cycle@100%

Electrical Safety Requirement:

Product Safety: The Product Complies when used with Company supplied Power
Supply (tested to EN 60950)

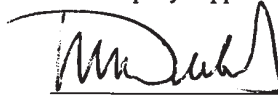
Corporate Quality Director

Morgan Hill, CA

25-SEP-01
Date

European Contact: For Anritsu product EMC & LVD information, contact Anritsu LTD, Rutherford Close,
Stevenage Herts, SG1 2EF UK, (FAX 44-1438-740202)

Table of Contents

Chapter 1 - General Information

Introduction	1-1
Description	1-1
Standard Accessories	1-1
Options	1-2
Optional Accessories	1-2
Performance Specifications	1-3
Preventive Maintenance	1-6
Calibration	1-6
InstaCal Module	1-7
Annual Verification	1-7

Chapter 2 - Functions and Operations

Introduction	2-1
Test Connector Panel	2-1
Front Panel Overview	2-2
Function Hard Keys	2-3
Keypad Hard Keys	2-4
Soft Keys	2-6
Power Monitor Menu	2-15
Symbols	2-19
Self Test	2-19
Error Codes	2-19
Self Test Errors	2-19
Range Errors	2-21
InstaCal Error Messages	2-22
Battery Information	2-24
Charging a New Battery	2-24
Charging the Battery in the Site Master	2-24
Charging the Battery in the Optional Charger	2-24
Battery Charge Indicator	2-25
Battery Life	2-25
Important Battery Information	2-26

Chapter 3 - Getting Started

Introduction	3-1
Power On Procedure	3-1
Select the Frequency or Distance	3-2
Calibration	3-2
Calibration Verification	3-3
Manual Calibration Procedure	3-4
InstaCal Module Verification	3-5
InstaCal Module Calibration Procedure	3-6
Calibration with the Test Port Extension Cable	3-6

Setting the Scale.	3-7
Auto Scale	3-7
Amplitude Scale.	3-7
Save and Recall a Setup	3-7
Saving a Setup	3-7
Recalling a Setup	3-8
Save and Recall a Display	3-8
Saving a Display	3-8
Recalling a Display	3-8
Set the Distance and Cable Type	3-9
Changing the Units	3-9
Changing the Display Language.	3-9
Printing.	3-10
Printing a Screen	3-10
Printer Switch Settings	3-11
Using the Soft Carrying Case.	3-12

Chapter 4 - Cable & Antenna Measurements

Introduction.	4-1
Line Sweep Fundamentals	4-1
Information Required for a Line Sweep	4-2
Typical Line Sweep Test Procedures	4-3
System Return Loss Measurement	4-3
Insertion Loss Measurement	4-4
Distance-To-Fault (DTF) Transmission Line Test	4-8
Antenna Subsystem Return Loss Test	4-10

Chapter 5 - Spectrum Analyzer Measurements

Introduction.	5-1
Occupied Bandwidth	5-1
Channel Power Measurement	5-2
Channel Power Measurement with the Site Master	5-2
Adjacent Channel Power Measurement	5-4
Out-of-Band Spurious Emission Measurements	5-6
In-Band/Out-of-Channel Measurements	5-7
Field Strength Measurement.	5-8
Antenna Calculations.	5-9

Chapter 6 - Power Measurement

Introduction.	6-1
Power Measurement	6-1

Chapter 7 - Site Master Software Tools

Introduction	7-1
Features	7-1
System Requirements	7-1
Installation	7-2
Communication Port Setting	7-2
Interface Cable Installation	7-3
Using Software Tools	7-3
Downloading Traces from the Site Master	7-3
Plot Capture	7-4
Plot Properties	7-4
Trace Overlay or Plot Overlay	7-5
Saving Traces	7-5
Custom Cable List	7-6
Entering Antenna Factors	7-7
Uploading Antenna Factors	7-8
Creating a Database	7-8
Printing Formats	7-8

Appendix A - Reference Data

Coaxial Cable Technical Data	A-1
---	------------

Appendix B - Windowing

Introduction	B-1
Examples	B-1



Chapter 1

General Information

Introduction

This chapter provides a description, performance specifications, optional accessories, preventive maintenance, and calibration requirements for the Site Master models S113C, S114C, S331C, and S332C. Throughout this manual, the term Site Master will refer to the models S113C, S114C, S331C, and S332C.

1

Model	Frequency Range
S113C	2 to 1600 MHz
S114C	2 to 1600 MHz, 100 kHz to 1600 MHz Spectrum Analysis
S331C	25 to 4000 MHz
S332C	25 to 4000 MHz, 100 kHz to 3000 MHz Spectrum Analysis

Description

The Site Master is a hand held SWR/RL (standing wave ratio/return loss), and Distance-To-Fault (DTF) measurement instrument that includes a built-in synthesized signal source. All models include a keypad to enter data and a liquid crystal display (LCD) to provide graphic indications of SWR or RL over the selected frequency range and selected distance. The Site Master is capable of up to 2.5 hours of continuous operation from a fully charged field-replaceable battery and can be operated from a 12.5 dc source. Built-in energy conservation features can be used to extend battery life over an eight-hour work day.

The Site Master is designed for measuring SWR, return loss, or cable insertion loss and locating faulty RF components in antenna systems. Power monitoring is available as an option. Site Master models S114C and S332C include spectrum analysis capability. The displayed trace can be scaled or enhanced with frequency markers or limit lines. A menu option provides for an audible “beep” when the limit value is exceeded. To permit use in low-light environments, the LCD can be back lit using a front panel key.

Standard Accessories

The Software Tools PC-based software program provides a database record for storing measurement data. Site Master Software Tools can also convert the Site Master display to a Microsoft Windows™ 95/98/NT4/2000/ME workstation graphic. Measurements stored in the Site Master internal memory can be downloaded to the PC using the included null-modem serial cable. Once stored, the graphic trace can be displayed, scaled, or enhanced with markers and limit lines. Historical graphs can be overlaid with current data, and underlying data can be extracted and used in spreadsheets or for other analytical tasks.

The Site Master Software Tools program can display all of the measurements made with the Site Master (SWR, return loss, cable loss, distance-to-fault) as well as providing other functions, such as converting display modes and Smith charts. Refer to Chapter 7, Software Tools, for more information.

The following items are supplied with the basic hardware.

- Soft Carrying Case
- AC-DC Adapter
- Automotive Cigarette Lighter 12 Volt DC Adapter,
- CDROM disk containing the Software Tools program. This program contains Fault Location (DTF) and Smith Chart functions
- Serial Interface Cable (null modem type)
- InstaCal Module
- One year Warranty (includes battery, firmware, and software)
- User's Guide

Options

- Option 5 — Add Power Monitor

Optional Accessories

- Anritsu Precision N (m) Open/Short/Load, 42 dB, Part No. OSLN50LF
- Anritsu Precision N (f) Open/Short/Load, 42 dB, Part No. OSLNF50LF
- Anritsu Precision N (m) Short/Open, Part No. 22N50
- Anritsu Precision N (f) Short/Open, Part No. 22NF50
- Site Master Precision N (m) Load, 42 dB, Part No. SM/PL
- Site Master Precision N (f) Load, 42 dB, Part No. SM/PLNF
- 7/16 (m) Precision Open/Short/Load, Part No. 2000-767
- 7/16 (f) Precision Open/Short/Load, Part No. 2000-768
- Adapter, Precision N (m) to N (m), Part No. 34NN50A
- Adapter, Precision N (f) to N (f), Part No. 34NFN50
- Adapter, 7/16 (f) to N (m), Part No. 510-90
- Adapter, 7/16 (f) to N (f), Part No. 510-91
- Adapter, 7/16 (m) to N (m), Part No. 510-92
- Adapter, 7/16 (m) to N (f), Part No. 510-93
- Adapter, 7/16 DIN (m) to 7/16 DIN (m), Part No. 510-96
- Adapter, 7/16 DIN (f) to 7/16 DIN (f), Part No. 510-97
- Armored Test Port Extension Cable, 1.5 meter, N (m) to N (f), Part No. 15NNF50-1.5C
- Armored Test Port Extension Cable, 3.0 meter, N (m) to N (f), Part No. 15NNF50-3.0C
- Armored Test Port Extension Cable, 5.0 meter, N (m) to N (f), Part No. 15NNF50-5.0C
- Armored Test Port Extension Cable, 1.5 meter, N (m) to N (m), Part No. 15NN50-1.5C

- Armored Test Port Extension Cable, 3.0 meter, N (m) to N (m), Part No. 15NN50-3.0C
- Armored Test Port Extension Cable, 5.0 meter, N (m) to N (m), Part No. 15NN50-5.0C
- Armored Test Port Extension Cable, 1.5 meter, N (m) to 7/16 DIN (f), Part No. 15NDF50-1.5C
- Armored Test Port Extension Cable, 1.5 meter, N (m) to 7/16 DIN (m), Part No. 15ND50-1.5C
- RF Detector, 1 to 3000 MHz, N(m) input connector, 50 Ohms, Part No. 5400-71N50
- RF Detector, 0.01 to 20 GHz, N(m) input connector, 50 Ohms, Part No. 560-7N50B
- Transit Case for Site Master, Part No. 760-215A
- Antenna SMA (f), 50 Ω , 1.71 to 1.88 GHz, Part No. 2000-1030
- Antenna SMA (f), 50 Ω , 1.85 to 1.99 GHz, Part No. 2000-1031
- Antenna SMA (f), 50 Ω , 2.4 to 2.5 GHz, Part No. 2000-1032
- Antenna SMA (f), 50 Ω , 806 to 869 MHz, Part No. 2000-1034
- Antenna SMA (f), 50 Ω , 896 to 941 MHz, Part No. 2000-1035
- HP Deskjet 350 Printer, Part No. 2000-766
- Serial-to-Parallel Converter Cable (use with the HP 350 Printer), Part No. 2000-753
- Seiko DPU-414 Thermal Printer, Part No. 2000-754 (U.S.) or 2000-761 (Europe)
- US Adapter (use with the DPU-414 Printer), Part No. 2000-1002
- Europe Adapter (use with the DPU-414 Printer) Part No. 2000-1003
- Japan Adapter (use with the DPU-414 Printer) Part No. 2000-1194
- Battery Pack (use with the DPU-414 Printer) Part No. 2000-1004
- Serial Interface Cable (use with the DPU-414 Printer), Part No. 2000-1012
- Thermal Paper (use with the DPU-411/DPU-414 Printer), Part No. 2000-755
- Rechargeable Battery, NiMH Part No. 633-27
- Battery Charger with universal power supply, NiMH only Part No. 2000-1029

Performance Specifications

Performance specifications are provided in Table 1-1, on the following page.

Chapter 1 General Information

Table 1-1. Performance Specifications (1 of 2)

Specifications are valid when the unit is calibrated at ambient temperature after a 5 minute warmup. Typical values are provided for reference only and are not guaranteed.

<u>Description</u>	<u>Value</u>
Site Master:	Frequency Range:
S113C, S114C	2 to 1600 MHz
S331C, S332C	25 to 4000 MHz
Frequency Accuracy (RF Source Mode)	≤75 parts per million @ 25°C*
Frequency Resolution: S113C, S114C	10 kHz
S331C, S332C	100 kHz
SWR: Range	1.00 to 65.00
Resolution	0.01
Return Loss: Range	0.00 to 54.00 dB
Resolution	0.01 dB
**Distance-To-Fault (DTF):	
Vertical Range Return Loss:	0.00 to 54.00 dB
SWR:	1.00 to 65.00
Horizontal Range	0 to ((# of data points -1) × resolution) a maximum of 1000m (3281 ft.) with a maximum of 517 points resolution, # of data pts. = 130, 259, 517
Horizontal Resolution for Coax (rectangular windowing)	$\frac{(1.5 \times 10^8)(V_p)}{\Delta F}$ Where V_p is the relative propagation velocity of the cable; dp is the number of data points (130, 259, 517); ΔF is the stop frequency minus the start frequency (Hz)
Horizontal Resolution for Waveguide	$\frac{1.5 \times 10^8 \sqrt{1 - (F_C / F_1)^2}}{\Delta F}$ Where F_C is the waveguide cutoff frequency (Hz); F_1 is the start frequency (Hz); ΔF is the stop frequency minus the start frequency (Hz)
RF Power Monitor:	
Display Range	-80.0 to +80 dBm or 10.0 pW to 100.0 kW
Detector Range	-50 dBm to +20 dBm, or 10 μW to 100 mW
Offset Range	0 to +60.0 dB
Resolution	0.1 dB or 0.1 W
Test Port Connector	Type N, 50Ω, female
***Immunity to Interfering signals	on-channel on-frequency
up to the level of: S113C, S114C	+17 dBm +10 dBm
S331C, S332C	+17 dBm -6 dBm
Maximum Input without Damage:	
Test Port, Type N (f)	+20 dBm, 50Ω, +50 VDC
RF Power Detector	+20 dBm, 50Ω, +50 VDC
Measurement Accuracy:	
Measurement accuracy depends on calibration components. Precision calibration components have a directivity of 42 dB.	
Cable Insertion Loss: Range	0.00 to 54.00 dB
Resolution	0.01 dB
Transmission Line Loss (one-port)	
Range	0.00 to 20.00 dB
Resolution	0.01 dB

Table 1-2. Performance Specifications (2 of 2)

Spectrum Analyzer:		
Frequency Range	S114C	100 kHz to 1.6 GHz
	S332C	100 kHz to 3.0 GHz
Frequency Reference	Aging	±1 ppm/yr
	Accuracy	±2 ppm
Frequency Span	S114C	0 Hz (zero span) 100 kHz to 1.6 GHz
	S332C	0 Hz (zero span) 100 kHz to 3.0 GHz
Sweep Time		≥650 ms (full span) 500 ms (zero span)
Resolution Bandwidth		10 kHz, 30 kHz, 100 kHz, 1 MHz
	Accuracy	± 20% typical
Video Bandwidth		100 Hz to 300 kHz in 1-3 sequence
SSB Phase Noise (1 GHz) @ 30 kHz offset		≤ -75 dBc/Hz
Spurious Responses, Input Related		≤ -45 dBc
Spurious Residual Responses		≤ -95 dBm
Note: 10 kHz resolution bandwidth, input terminated, no attenuation		
Amplitude		
Measurement Range		-97 dBm to +20 dBm typical
Dynamic Range		≥ 65 dB typical
Maximum Safe Input Level		+20 dBm, maximum measurable safe input +27 dBm, maximum input (damage) +27 dBm, peak pulse power +50 Vdc
Displayed Average Noise Level:		≤ -80 dBm (100 kHz to 300 kHz) typical ≤ -97 dBm (>300 kHz) typical
Display Range, Log Scale		2 to 15 dB/div. in 1 dB steps; 10 divisions displayed.
Frequency Response		
RF Input VSWR		2.0:1
Resolution (Ref. Level)		1.0 dB
Total Level Accuracy		±2 dB ≥ 300 kHz typical ±3 dB <300 kHz typical
General		
Internal Memory:		
Trace Memory		200 maximum
Instrument configuration		10 setup locations
RS-232		9 pin D-sub, three wire serial
Electromagnetic Compatibility		Complies with European community requirements for CE marking
Power Supply:		
External DC Input		+12.5 to +15 Vdc, 1100 mA max.
Temperature:	Storage	-20° C to 75° C
	Operating	0° C to 50° C
Weight:		2.15 kg (4.76 pounds)
Dimensions:		25.4 x 17.8 x 6.1 cm (10 x 7 x 2.4 inches)

* ±2 ppm/Δ°C from 25°C

** Fault location is accomplished by inverse Fourier Transformation of data taken with the Site Master. Resolution and maximum range depend on the number of frequency data points, frequency sweep range and relative propagation velocity of the cable being tested.

*** Immunity measurement is made in CW mode with incoming interfering signal exactly at the same frequency (worst case situation). Typical immunity is better when swept frequency is used.

Preventive Maintenance

Site Master preventive maintenance consists of cleaning the unit and inspecting and cleaning the RF connectors on the instrument and all accessories.

Clean the Site Master with a soft, lint-free cloth dampened with water or water and a mild cleaning solution.

CAUTION: To avoid damaging the display or case, do not use solvents or abrasive cleaners.

Clean the RF connectors and center pins with a cotton swab dampened with denatured alcohol. Visually inspect the connectors. The fingers of the N (f) connectors and the pins of the N (m) connectors should be unbroken and uniform in appearance. If you are unsure whether the connectors are good, gauge the connectors to confirm that the dimensions are correct.

Visually inspect the test port cable(s). The test port cable should be uniform in appearance, not stretched, kinked, dented, or broken.

Calibration

The Site Master is a field portable unit operating in the rigors of the test environment. An Open-Short-Load (OSL) calibration should be performed prior to making a measurement in the field (see Calibration, page 3-2). A built-in temperature sensor in the Site Master advises the user, via an icon located on the right side of the LCD screen, that the internal temperature has exceeded a safety window, and the user is advised to perform another OSL calibration in order to maintain the integrity of the measurement.

NOTES:

For best calibration results—compensation for all measurement uncertainties—ensure that the Open/ Short/Load is at the end of the test port or optional extension cable; that is, at the same point that you will connect the antenna or device to be tested.

For best results, use a phase stable Test Port Extension Cable (see Optional Accessories). If you use a typical laboratory cable to extend the Site Master test port to the device under test, cable bending subsequent to the OSL calibration will cause uncompensated phase reflections inside the cable. Thus, cables which are NOT phase stable may cause measurement errors that are more pronounced as the test frequency increases.

For optimum calibration, Anritsu recommends using precision calibration components.

InstaCal Module

The Anritsu InstaCal module can be used in place of discrete components to calibrate the Site Master. The InstaCal module can be used to perform an Open, Short and Load (OSL) calibration procedure. Calibration of the Site Master with the InstaCal takes approximately 45 seconds (see Calibration, page 3-2). Unlike a discrete calibration component, the InstaCal module can not be used at the top of the tower to conduct load or insertion loss measurements. The module operates from 2 MHz to 4 GHz and weighs eight ounces.

Anritsu recommends annual re-characterization of the InstaCal module to verify performance with precision instrument data. The re-characterization can be performed at a local service center or at the factory.

Annual Verification

Anritsu recommends an annual calibration and performance verification of the Site Master and the OSL calibration components and InstaCal module by local Anritsu service centers. Anritsu service centers are listed in Table 1-2 on the following page.

The Site Master itself is self-calibrating, meaning that there are no field-adjustable components. However, the OSL calibration components are crucial to the integrity of the calibration and therefore, must be verified periodically to ensure performance conformity. This is especially important if the OSL calibration components have been accidentally dropped or over-torqued.

Chapter 1 General Information

Table 1-2. Anritsu Service Centers

UNITED STATES

ANRITSU COMPANY
685 Jarvis Drive
Morgan Hill, CA 95037-2809
Telephone: (408) 776-8300,
1-800-ANRITSU
FAX: 408-776-1744

ANRITSU COMPANY
10 New Maple Ave., Unit 305
Pine Brook, NJ 07058
Telephone: (201) 227-8999,
1-800-ANRITSU
FAX: 201-575-0092

ANRITSU COMPANY
1155 E. Collins Blvd
Richardson, TX 75081
Telephone: 1-800-ANRITSU
FAX: 972-671-1877

AUSTRALIA

ANRITSU PTY. LTD.
Unit 3, 170 Foster Road
Mt. Waverley, VIC 3149
Australia
Telephone: 03-9558-8177
Fax: 03-9558-8255

BRAZIL

ANRITSU ELECTRONICA LTDA.
Praia de Botafogo 440, Sala 2401
CEP 22250-040, Rio de Janeiro, RJ,
Brasil
Telephone: 021-28-69-141
Fax: 021-53-71-456

CANADA

ANRITSU INSTRUMENTS LTD.
215 Stafford Road, Unit 102
Nepean, Ontario K2H 9C1
Telephone: (613) 828-4090
FAX: (613) 828-5400

CHINA

ANRITSU (SHANGHAI) ACSH
2F, Rm. B, 52 Section Factory Building
No. 516 Fu Te Road (N)
Waigaoqiao Free Trade Zone
Pudong, Shanghai 200131
Telephone: 021-5868-0226
FAX: 021-5868-0588

FRANCE

ANRITSU S.A
9 Avenue du Quebec
Zone de Courtaboeuf
91951 Les Ulis Cedex
Telephone: 016-44-66-546
FAX: 016-44-61-065

GERMANY

ANRITSU GmbH
Grafenberger Allee 54-56
D-40237 Dusseldorf, Germany
Telephone: 0211-96 85 50
FAX: 0211-96 85 555

INDIA

MEERA AGENCIES (P) LTD
A-23 Hauz Khas
New Delhi 110 016
Telephone: 011-685-3959
FAX: 011-686-6720

ISRAEL

TECH-CENT, LTD
Haarad St. No. 7, Ramat Haahayal
Tel-Aviv 69701
Telephone: (03) 64-78-563
FAX: (03) 64-78-334

ITALY

ANRITSU Sp.A
Rome Office
Via E. Vittorini, 129
00144 Roma EUR
Telephone: (06) 50-22-666
FAX: (06) 50-22-4252

JAPAN

ANRITSU CORPORATION
1800 Onna Atsugi-shi
Kanagawa-Prf. 243 Japan
Telephone: 0462-23-1111
FAX: 0462-25-8379

KOREA

ANRITSU CORPORATION LTD.
#901 Daero Bldg. 26-5
Yeoido Dong, Youngdeungpo
Seoul Korea 150 010
Telephone: 02-782-7156
FAX: 02-782-4590

SINGAPORE

ANRITSU (SINGAPORE) PTE LTD
10, Hoe Chiang Road
#07-01/02
Keppel Towers
Singapore 089315
Telephone: 65-2822400
FAX: 65-2822533

SOUTH AFRICA

ETESCSA
12 Surrey Square Office Park
330 Surrey Avenue
Ferndale, Randburt, 2194
South Africa
Telephone: 01-11-787-7200
Fax: 01-11-787-0446

SWEDEN

ANRITSU AB
Botvid Center
S-1585
Stockholm, Sweden
Telephone: (08) 534-717-00
FAX: (08) 534-717-30

TAIWAN

ANRITSU CO., LTD.
8F, No. 96, Section 3
Chien Kuo N. Road
Taipei, Taiwan, R.O.C.
Telephone: (02) 515-6050
FAX: (02) 509-5519

UNITED KINGDOM

ANRITSU LTD.
200 Capability Green
Luton, Bedfordshire
LU1 3LU, England
Telephone: 015-82-41-88-53
FAX: 015-82-31-303

Chapter 2

Functions and Operations

Introduction

This chapter provides a brief overview of the Site Master functions and operations, providing the user with a starting point for making basic measurements. For more detailed information, refer to Chapter 4, *Measurements* and Chapter 7, *Software Tools*.

The Site Master is designed specifically for field environments and applications requiring mobility. As such, it is a lightweight, handheld, battery operated unit which can be easily carried to any location, and is capable of up to 2.5 hours of continuous operation from a fully charged battery. Built-in energy conservation features allow battery life to be extended over an eight-hour workday. The Site Master can also be powered by a 12.5 Vdc external source. The external source can be either the Anritsu AC-DC Adapter (P/N 40-115) or 12.5 Vdc Automotive Cigarette Lighter Adapter (P/N 806-62). Both items are standard accessories.

2

Test Connector Panel

The connectors and indicators located on the test panel are listed and described below.

12.5-15VDC (1100 mA) 12.5 to 15 Vdc @ 1100 mA input to power the unit or for battery charging.

WARNING

When using the AC-DC Adapter, always use a three-wire power cable connected to a three-wire power line outlet. If power is supplied without grounding the equipment in this manner, there is a risk of receiving a severe or fatal electric shock.

Battery Charging	Illuminates when the battery is being charged. The indicator automatically shuts off when the battery is fully charged.
External Power	Illuminates when the Site Master is being powered by the external charging unit.
Serial Interface	RS232 DB9 interface to a COM port on a personal computer (for use with the Anritsu Software Tools program) or to a supported printer.
RF Out	RF output, 50 Ω impedance, for reflection measurements.
RF In	RF input, 50 Ω impedance, for spectrum analysis measurements.
RF Detector	RF detector input for the Power Monitor.

Front Panel Overview

The Site Master menu-driven user interface is easy to use and requires little training. Hard keys on the front panel are used to initiate function-specific menus. There are four function hard keys located below the display, Mode, Frequency/Distance, Amplitude and Sweep.

There are seventeen keypad hard keys located to the right of the display. Twelve of the keypad hard keys perform more than one function, depending on the current mode of operation. The dual purpose keys are labeled with one function in black, the other in blue.

There are also six soft keys that change function depending upon the current mode selection. The current soft key function is indicated in the active function block to the right of the display. The locations of the different keys are illustrated in Figure 2-1.

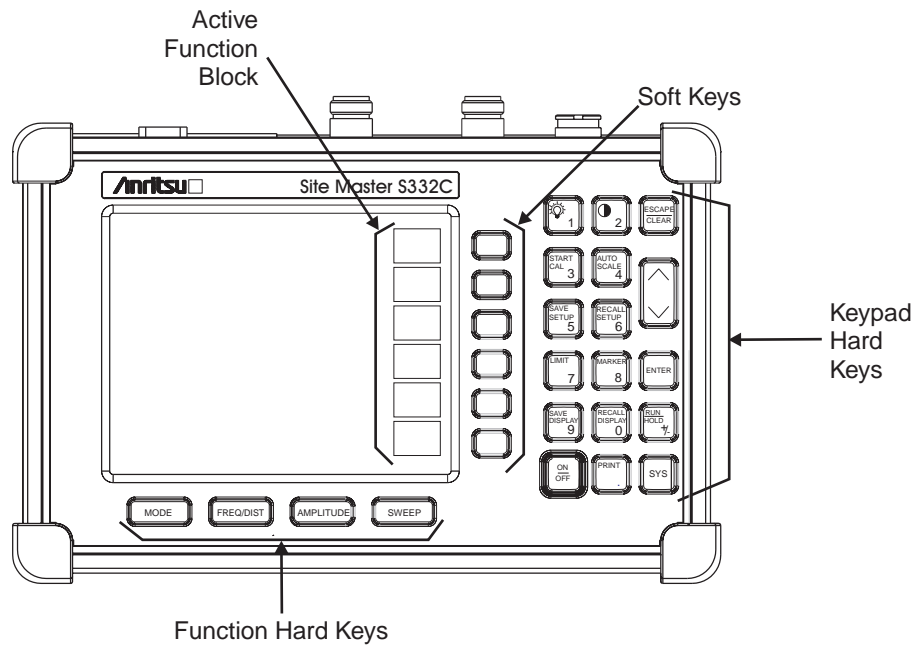

Figure 2-1. Site Master Soft Keys

The following sections describe the various key functions.

Function Hard Keys

MODE Opens the mode selection box (below). Use the Up/Down arrow key to select a mode. Press the **ENTER** key to implement.

MEASUREMENT MODE
FREQ - SWR
RETURN LOSS
CABLE LOSS - ONE PORT
DTF - SWR
RETURN LOSS
POWER MONITOR
SPECTRUM ANALYZER

Figure 2-2. Mode Selection Box

FREQ/DIST Displays the Frequency or Distance to Fault softkey menus depending on the measurement mode.

AMPLITUDE Displays the amplitude softkey menu for the current operating mode.

SWEEP Displays the Sweep function softkey menu for the current operating mode.

Keypad Hard Keys

This section contains an alphabetical listing of the Site Master front panel keypad controls along with a brief description of each. More detailed descriptions of the major function keys follow.

The following keypad hard key functions are printed in **black** on the keypad keys.

- 
- 0-9** These keys are used to enter numerical data as required to setup or perform measurements.
 - +/-** The plus/minus key is used to enter positive or negative values as required to setup or perform measurements.
 - .** The decimal point is used to enter decimal values as required to setup or perform measurements.
 - ESCAPE
CLEAR** Exits the present operation or clears the display. If a parameter is being edited, pressing this key will clear the value currently being entered and restore the last valid entry. Pressing this key again will close the parameter. During normal sweeping, pressing this key will move up one menu level.
 - UP/DOWN
ARROWS** Increments or decrements a parameter value. The specific parameter value affected typically appears in the message area of the LCD.

*NOTE: At turn on, before any other keys are pressed, the Up/Down arrow key may be used to adjust the display contrast. Press **ENTER** to return to normal operation.*

- ENTER** Implements the current action or parameter selection.
- ON
OFF** Turns the Anritsu Site Master on or off. When turned on, the system state at the last turn-off is restored. If the **ESCAPE/CLEAR** key is held down while the **ON/OFF** key is pressed, the factory preset state will be restored.
- SYS** Allows selection of display language and system setup parameters. Choices are **OPTIONS**, **CLOCK**, **SELF TEST**, **STATUS** and **LANGUAGE**.

The following keypad hard key functions are printed in **blue** on the keypad keys.



Turns the liquid crystal display (LCD) back-lighting ON or OFF. (Leaving back lighting off conserves battery power.)



LCD Contrast adjust. Use the Up/Down arrow key and **ENTER** to adjust the display contrast.

AUTO SCALE

Automatically scales the display for optimum resolution.

LIMIT

Displays the limit line menu for the current operating mode.

MARKER

Displays the marker menu of the current operating mode.

PRINT

Prints the current display to the selected printer via the RS232 serial port.

RECALL DISPLAY

Recalls a previously saved trace from memory. When the key is pressed, a Recall Trace selection box appears on the display. Select a trace using the Up/Down arrow key and press the **ENTER** key to implement.

To erase a saved trace, highlight the trace and select the **DELETE TRACE** softkey. To erase all saved traces, select the **DELETE ALL TRACES** softkey.

RECALL SETUP

Recalls a previously saved setup from memory location 1 through 10. When the key is pressed, a **RECALL SETUP** selection box appears on the display. Select a setup using the Up/Down arrow key and press the **ENTER** key to implement. Setup 0 recalls the factory preset state.

RUN HOLD

When in the Hold mode, this key starts the Site Master sweeping and provides a Single Sweep Mode trigger; when in the Run mode, it pauses the sweep. When in the Hold mode, the hold symbol (page 2-19) appears on the display. Hold mode conserves battery power.

SAVE DISPLAY

Saves up to 200 displayed traces to non-volatile memory. When the key is pressed, **TRACE NAME:** appears in the lower left of the display. Save the display with up to 16 alphanumeric characters for that trace name and press the **ENTER** key to implement.

SAVE SETUP

Saves the current system setup to 1 of 10 internal non-volatile memory locations. When the key is pressed, a **SAVE SETUP** selection box appears on the display. Use the Up/Down arrow key to select a setup and press the **ENTER** key to implement.

START CAL

Starts the calibration in SWR, Return Loss, Cable Loss, or DTF measurement modes (not available in Spectrum Analyzer mode).



Soft Keys

Each keypad key opens a set of soft key selections. Each of the soft keys has a corresponding soft key label area on the display. The label identifies the function of the soft key for the current Mode selection.

Figures 2-3 through 2-7 show the soft key labels for each Mode selection.

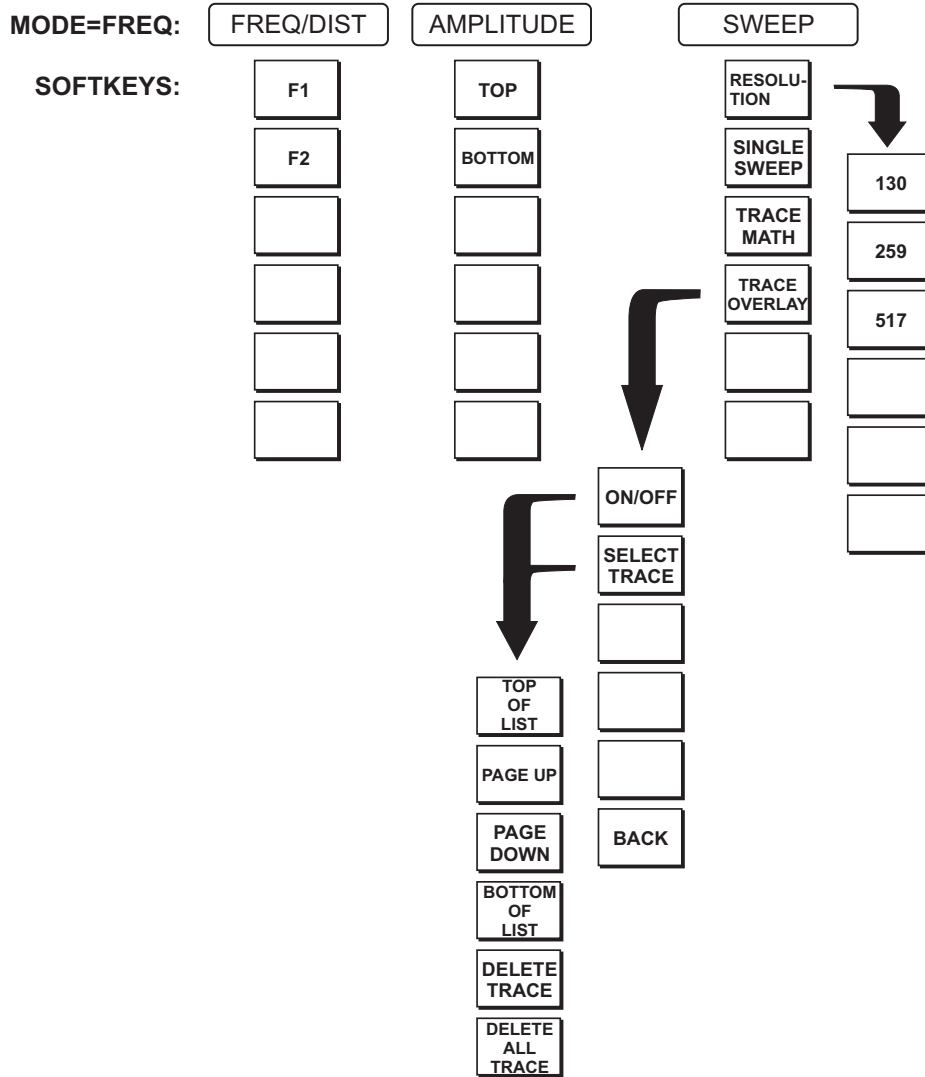

Figure 2-3. Frequency Mode Soft Key Labels

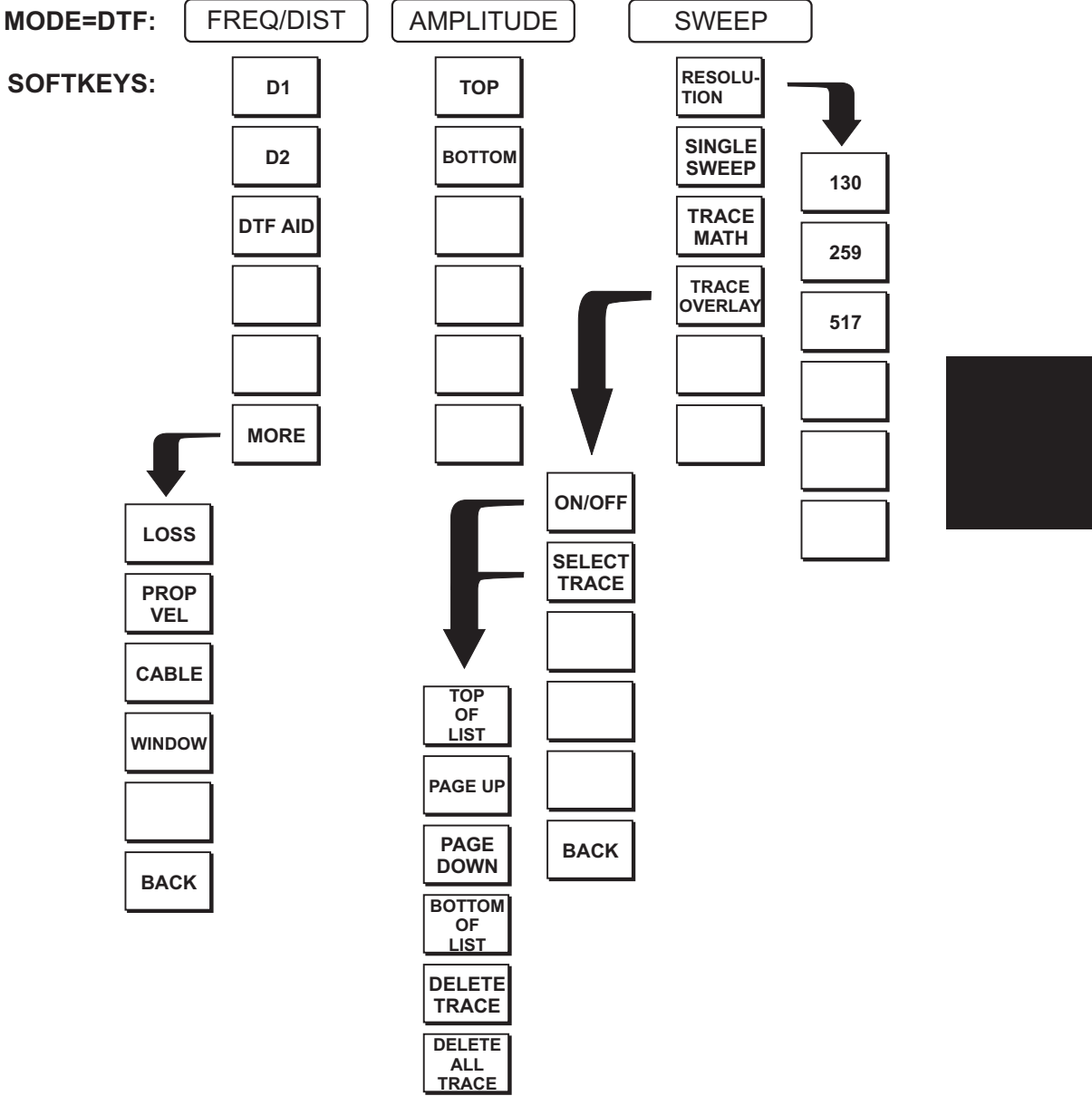

Figure 2-4. Distance to Fault Mode Soft Key Labels

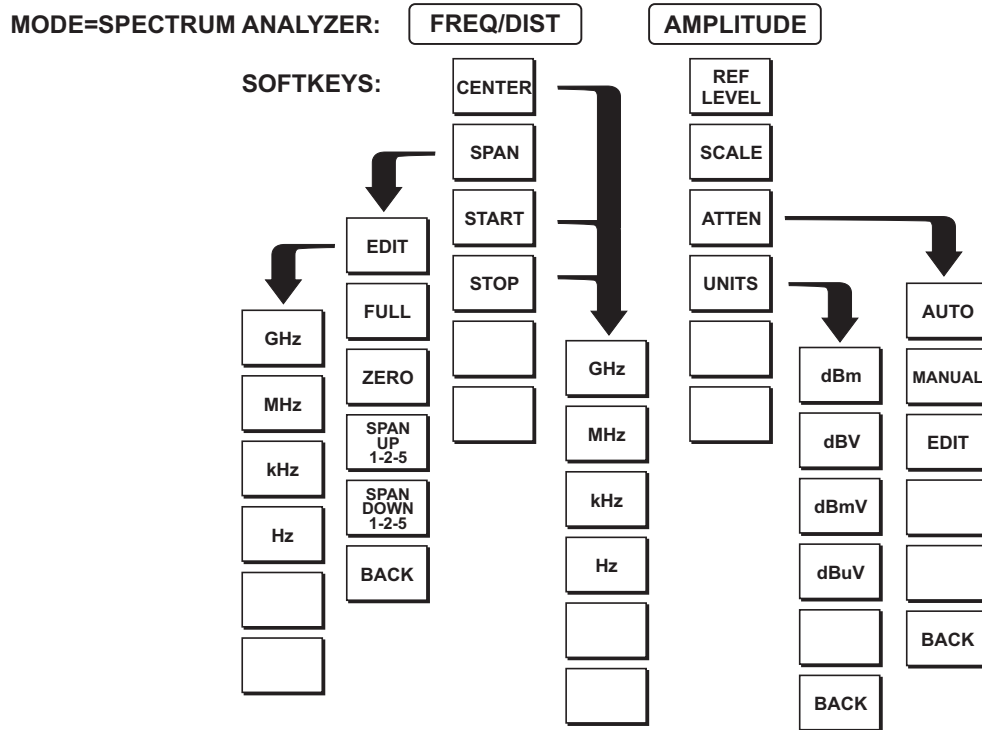

Figure 2-5. Spectrum Analyzer Mode Soft Key Labels

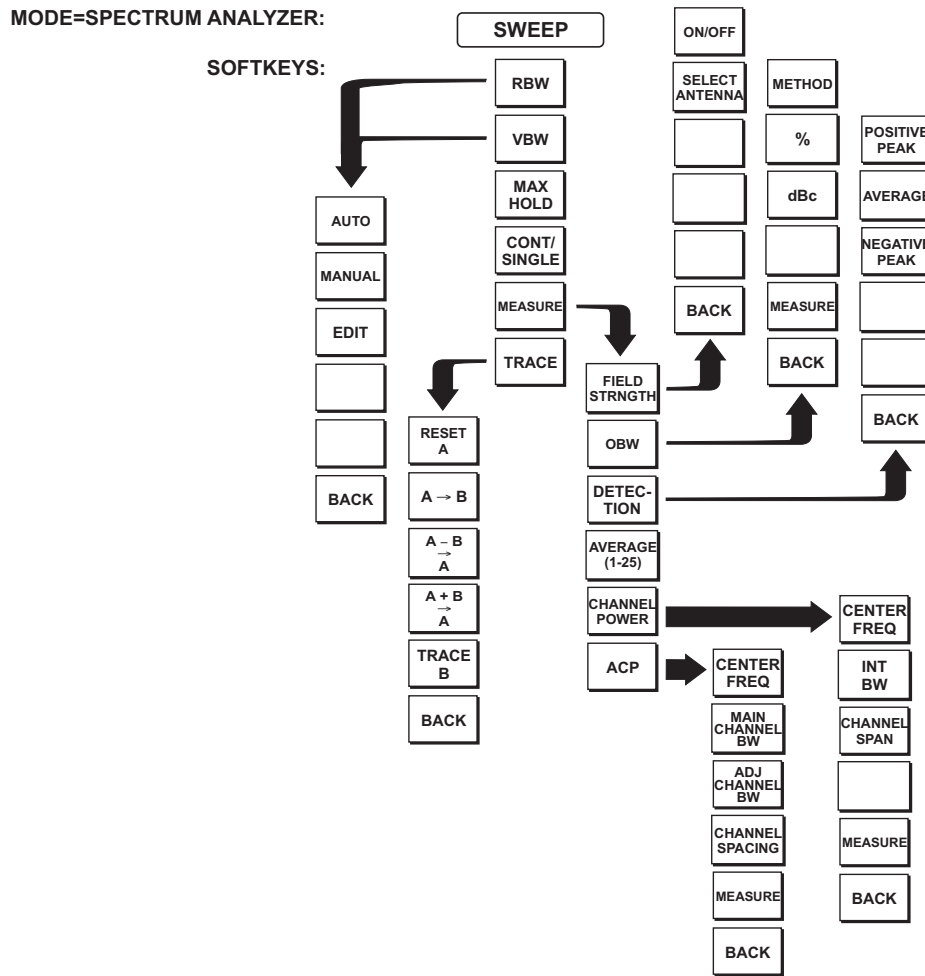

Figure 2-7. Spectrum Analyzer Mode Soft Key Labels (continued)

MODE=POWER MONITOR:

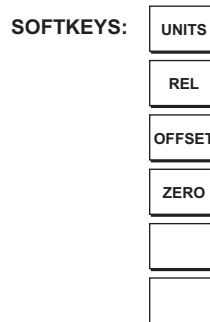

Figure 2-6. Power Monitor Mode Soft Key Labels

FREQ/DIST Displays the frequency and distance menu depending on the measurement mode.

Frequency Menu Provides for setting sweep frequency end points when **FREQ** mode is selected. Selected frequency values may be changed using the keypad or Up/Down arrow key.

- ❑ **F1** — Opens the F1 parameter for data entry. This is the start value for the frequency sweep. Press **ENTER** when data entry is complete.
- ❑ **F2** — Opens the F2 parameter for data entry. This is the stop value for the frequency sweep. Press **ENTER** when data entry is complete.

Distance Menu Provides for setting Distance to Fault parameters when a DTF mode is selected. Choosing **DIST** causes the soft keys, below, to be displayed and the corresponding values to be shown in the message area. Selected distance values may be changed using the keypad or Up/Down arrow key.

- ❑ **D1** — Opens the start distance (D1) parameter for data entry. This is the start value for the distance range (D1 default = 0). Press **ENTER** when data entry is complete.
- ❑ **D2** — Opens the end distance (D2) parameter for data entry. This is the end value for the distance range. Press **ENTER** when data entry is complete.
- ❑ **DTF AID** — Provides interactive help to optimize DTF set up parameters. Use the Up/Down arrow key to select a parameter to edit. Press **ENTER** when data entry is complete.
- ❑ **MORE** — Selects the Distance Sub-Menu, detailed below.

Distance Sub-Menu Provides for setting the cable loss and relative propagation velocity of the coaxial cable. Selected values may be changed using the Up/Down arrow key or keypad.

- ❑ **LOSS** — Opens the Cable Loss parameter for data entry. Enter the loss per foot (or meter) for the type of transmission line being tested. Press **ENTER** when data entry is complete. (Range is 0.5 to 5.000 dB/m, 1.524 dB/ft)
- ❑ **PROP VEL** (relative propagation velocity) — Opens the Propagation Velocity parameter for data entry. Enter the propagation velocity for the type of transmission line being tested. Press **ENTER** when data entry is complete. (Range is 0.010 to 1.000)
- ❑ **CABLE** — Opens a list of cable folders for selection of a common coaxial cable folder or custom coaxial cable folder. Select either folder and use the Up/Down arrow key and **ENTER** to make a selection. This feature provides a rapid means of setting both cable loss and propagation velocity. (Refer to Appendix A for a listing of common coaxial cables showing values for Relative Propagation Velocity and Nominal Attenuation in dB/m or dB/ft @ 1000 MHz, 2000 MHz and 2500 MHz.) The custom cable folder can consist of up to 24 user-defined cable parameters downloaded via the Site Master Software Tools program.
- ❑ **WINDOW** — Opens a menu of FFT windowing types for the DTF calculation. Scroll the menu using the Up/Down arrow key and make a selection with the **ENTER** key.
- ❑ **BACK** — Returns to the Distance Menu.

Choosing **FREQ/DIST** in Spectrum Analyzer mode causes the soft keys, below, to be displayed and the corresponding values to be shown in the message area.

- ❑ **CENTER** — Sets the center frequency of the Spectrum Analyzer display . Enter a value using the Up/Down arrow key or keypad, press **ENTER** to accept, **ESCAPE** to restore previous value.
- ❑ **SPAN** — Sets the user-defined frequency span. Use the Up/Down arrow key or keypad to enter a value in MHz. Also brings up **FULL** and **ZERO** softkeys.
 - ❑ **EDIT** allows editing of the frequency span. Enter a value using the number keys.
 - ❑ **FULL** span sets the Spectrum Analyzer to its maximum frequency span.
 - ❑ **ZERO** span sets the span to 0 Hz. This displays the input signal in an amplitude versus time mode, which is useful for viewing modulation.
 - ❑ **SPAN UP 1-2-5** activates the span function so that the span may be increased quickly in a 1-2-5 sequence.
 - ❑ **SPAN DOWN 1-2-5** activates the span function so that the span may be reduced quickly in a 1-2-5 sequence.
 - ❑ **BACK** returns to the previous menu level.
- ❑ **START** — Sets the Spectrum Analyzer in the START-STOP mode. Enter a start frequency value (in kHz, MHz, or GHz) using the Up/Down arrow key or keypad, press **ENTER** to accept, **ESCAPE** to restore.
- ❑ **STOP** — Sets the Spectrum Analyzer in the START-STOP mode. Enter a stop frequency value (in kHz, MHz, or GHz) using the Up/Down arrow key or keypad, press **ENTER** to accept, **ESCAPE** to restore.



AMPLITUDE Displays the amplitude or scale menu depending on the measurement mode.

Amplitude Menu Provides for changing the display scale. Selected values may be changed using the Up/Down arrow key or keypad.

Choosing **AMPLITUDE** in **FREQ** or **DTF** measurement modes causes the soft keys, below, to be displayed and the corresponding values to be shown in the message area.

- TOP** — Opens the top parameter for data entry and provides for setting the top scale value. Press **ENTER** when data entry is complete.
- BOTTOM** — Opens the bottom parameter for data entry and provides for setting the bottom scale value. Press **ENTER** when data entry is complete.

Choosing **AMPLITUDE** in **SPECTRUM ANALYZER** mode causes the soft keys, below, to be displayed and the corresponding values to be shown in the message area.

- REF LEVEL** — Activates the amplitude reference level function.
- SCALE** — Activates the scale function in a 2 through 15 dB logarithmic amplitude scale.
- ATTEN** — Sets the Anritsu input attenuator so that it is either coupled automatically to the reference level (**AUTO**) or manually adjustable (**MANUAL**).
- UNITS** — Choose from the menu of amplitude related units. Selection of dBm sets absolute decibels relative to 1 mW as the amplitude unit. Selection of dBV, dBmV or dB μ V sets absolute decibels relative to 1 volt, 1 millivolt, or 1 microvolt respectively as the amplitude unit.



- SWEEP** Displays the Sweep function soft key menu for the current operating mode.
- Sweep Menu** Provides for changing the display resolution, single or continuous sweep, and access to the Trace Math functions.
- Choosing **SWEEP** in **FREQ** or **DTF** measurement modes causes the soft keys below to be displayed.
- ❑ **RESOLUTION** — Opens the display to change the resolution. Choose 130, 259, or 517 data points. (In DTF mode, resolution can be adjusted through the DTF-AID table.)
 - ❑ **SINGLE SWEEP** — Toggles the sweep between single sweep and continuous sweep. In single sweep mode, each sweep must be activated by the **RUN/HOLD** button.
 - ❑ **TRACE MATH** — Opens up the Trace Math functions (trace-memory or trace+memory) for comparison of the real time trace in the display with any of the traces from memory. (Not available in DTF mode.)
 - ❑ **TRACE OVERLAY** — Opens up the Trace Overlay functions menu to allow the current trace to be displayed with a trace in memory overlaid on it. Choose **ON** or **OFF** and **SELECT TRACE** to select the trace from memory to be overlaid.
- Choosing **SWEEP** in **SPECTRUM ANALYZER** mode causes the soft keys below to be displayed.
- ❑ **RBW** — Sets the resolution bandwidth so that it is either coupled automatically to the span (**AUTO**) or manually adjustable (**MANUAL**).
 - ❑ **VBW** — Sets the video bandwidth so that it is either coupled automatically to the span (**AUTO**) or manually adjustable (**MANUAL**).
 - ❑ **MAX HOLD** — Displays and holds the maximum responses of the input signal.
 - ❑ **CONT/SINGLE** — Toggles between continuous and single sweep.
 - ❑ **MEASURE** — Activates a menu of measurement related functions. Use the corresponding softkey to select the measurement function.
 - ❑ **FIELD STRENGTH** — Accesses a menu of field strength measurement options.
 - ON/OFF - Turns field strength measurements on or off.
 - SELECT ANTENNA - Selects an antenna profile to be used for field strength measurements.
 - BACK - Returns to the previous menu.
 - ❑ **OBW** — Activates the occupied bandwidth menu. Select either **METHOD**, **%** or **dBc** method of occupied bandwidth measurement. **METHOD** allows selection of either **%** of power or **dB Down**. Selecting **%** allows entry of the desired **%** of occupied bandwidth to be measured. Selecting **dBc** allows entry of the desired power level (**dBc**) to be measured.
 - ❑ **DETECTION** — Accesses a menu of detector modes including **POSITIVE PEAK** detection, **AVERAGE** detection and **NEGATIVE PEAK** detection.

- ❑ **AVERAGE (1-25)** — The display will be an average of the number of sweeps specified here. For example, if the number four is entered here, the data displayed will be an average of the four most recent sweeps.
- ❑ **CHANNEL POWER** — Activates Channel Power measurement. Channel power is measured in dBm. Channel Power density is measured in dBm/Hz.
- ❑ **ACP** — Accesses a menu of Adjacent Channel Power ratio measurement options:
 - CENTER FREQ** - Activates the center frequency function and sets the Anritsu Site Master to the center frequency. A specific center frequency can be entered using the keypad or Up/Down arrow key. Select the **GHZ**, **MHZ**, **KHZ**, or **Hz** softkey to accept the center frequency input.
 - MAIN CHANNEL BW** - Sets the bandwidth of the main channel.
 - ADJACENT CHANNEL BW** - Sets the bandwidth of the adjacent channel.
 - CHANNEL SPACING** - Sets the channel spacing.
 - MEASURE** - Begins the ACP measurement.
 - BACK** - Returns to the previous menu.
- ❑ **BACK** - Returns to the previous menu.
- ❑ **TRACE** — Activates a menu of trace related functions. Use the corresponding softkey to select the desired trace function.

NOTE: For this function, Trace A is always the runtime trace, and Trace B is always a saved trace. Refer to page for information on saving and recalling traces.

- ❑ **RESET A** — Clears the current runtime trace.
- ❑ **A → B** — Stores the current runtime trace into the Trace B buffer.
- ❑ **A – B → A** — Performs a subtraction trace math operation.
- ❑ **A + B → A** — Performs an addition trace math operation.
- ❑ **TRACE B** — Accesses a menu of saved trace options.
 - VIEW B** - Provides a trace overlay of the saved trace with the current runtime trace.
 - CLEAR B** - Turns off trace overlay.
 - RECALL TRACE → B** - Recalls the saved trace B buffer.
- ❑ **BACK** — Returns to the previous menu level.

Power Monitor Menu

Selecting **POWER MONITOR** from the Mode menu causes the soft keys, described below, to be displayed and the corresponding values shown in the message area.

- ❑ **UNITS** — Toggles between dBm and Watts.
- ❑ **REL** — Turns relative mode OFF, if currently ON. If relative mode is currently OFF, turns it ON and causes the power level to be measured and saved as the base level. Subsequent measurements are then displayed relative to this saved value. With units of dBm, relative mode displays dBr; with units of Watts, relative mode displays % (percent).
- ❑ **OFFSET** — Turns Offset OFF, if currently ON. If Offset is currently OFF, turns it ON and opens the Offset parameter for data entry. Press **ENTER** when data entry is complete.
Offset is the attenuation (in dB) inserted in the line between the DUT and the RF detector. The attenuation is added to the measured input level prior to display.
- ❑ **ZERO** — Turns Zero OFF, if currently ON. If Zero is currently OFF, this softkey turns it ON and initiates collection of a series of power level samples, which are averaged and saved. This saved value is then subtracted from subsequent measurements prior to display.



MARKER

Choosing **MARKER** causes the soft keys, below, to be displayed and the corresponding values to be shown in the message area. Selected frequency marker or distance marker values may be changed using the keypad or Up/Down arrow key.

- M1** — Selects the M1 marker parameter and opens the M1 marker second level menu.
 - ON/OFF** — Turns the selected marker on or off.
 - EDIT** — Opens the selected marker parameter for data entry. Press **ENTER** when data entry is complete or **ESCAPE** to restore the previous value.
 - MARKER TO PEAK** — Places the selected marker at the frequency or distance with the maximum amplitude value.
 - MARKER TO VALLEY** — Places the selected marker at the frequency or distance with the minimum amplitude value.
 - BACK** — Returns to the Main Markers Menu.
- M2 through M4** — Selects the marker parameter and opens the marker second level menu.
 - ON/OFF** — Turns the selected marker on or off.
 - EDIT** — Opens the selected marker parameter for data entry. Press **ENTER** when data entry is complete or **ESCAPE** to restore the previous value.
 - DELTA (Mx-M1)** — Displays delta amplitude value as well as delta frequency or distance for the selected marker with respect to the M1 marker.
 - MARKER TO PEAK** — Places the selected marker at the frequency or distance with the maximum amplitude value.
 - MARKER TO VALLEY** — Places the selected marker at the frequency or distance with the minimum amplitude value.
 - BACK** — Returns to the Main Markers Menu.
- M5** — Selects the M5 marker parameter and opens the M5 second level menu.
 - ON/OFF** — Turns the selected marker on or off.
 - EDIT** — Opens the selected marker parameter for data entry. Press **ENTER** when data entry is complete or **ESCAPE** to restore the previous value.
 - PEAK BETWEEN M1 & M2** — Places the selected marker at the frequency or distance with the maximum amplitude value between marker M1 and marker M2.
 - VALLEY BETWEEN M1 & M2** — Places the selected marker at the frequency or distance with the minimum amplitude value between marker M1 and marker M2.
 - BACK** — Returns to the Main Markers Menu.
- M6** — Selects the M6 marker parameter and opens the M6 second level menu.

- **ON/OFF** — Turns the selected marker on or off.
- **EDIT** — Opens the selected marker parameter for data entry. Press **ENTER** when data entry is complete or **ESCAPE** to restore the previous value.
- **PEAK BETWEEN M3 & M4** — Places the selected marker at the peak between marker M3 and marker M4.
- **VALLEY BETWEEN M3 & M4** — Places the selected marker at the valley between marker M3 and marker M4.
- **BACK** — Returns to the Main Markers Menu.

LIMIT

Pressing **LIMIT** on the data keypad activates a menu of limit related functions. Use the corresponding softkey to select the desired limit function. Then use the Up/Down arrow key to change its value, which is displayed in the message area at the bottom of the display.

Choosing **LIMIT** in **FREQ** or **DTF** measurement modes causes the soft keys below to be displayed.

- **SINGLE LIMIT** — Sets a single limit value in dBm. Menu choices are:
 - ON/OFF
 - EDIT
 - BACK
- **MULTIPLE LIMITS** — Sets multiple user defined limits, and can be used to create a limit mask for quick pass/fail measurements. Menu choices are:
 - SEGMENT 1
 - SEGMENT 2
 - SEGMENT 3
 - SEGMENT 4
 - SEGMENT 5
 - BACK
- **LIMIT BEEP** — Turns the audible limit beep indicator on or off.

Choosing **LIMIT** in **SPECTRUM ANALYZER** measurement mode causes the soft keys below to be displayed.

- **SINGLE LIMIT** — Sets a single limit value in dBm. Menu choices are:
 - ON/OFF
 - EDIT
 - BACK
- **MULTIPLE UPPER LIMITS** — Sets multiple user defined upper limits, and can be used to create an upper limit mask for quick pass/fail measurements. Menu choices are:
 - SEGMENT 1
 - SEGMENT 2
 - SEGMENT 3
 - SEGMENT 4
 - SEGMENT 5
 - BACK
- **MULTIPLE LOWER LIMITS** — Set multiple user defined lower limits, and can be used to create a lower limit mask for quick pass/fail measurements. Menu choices are:

SEGMENT 1
SEGMENT 2
SEGMENT 3
SEGMENT 4
SEGMENT 5
BACK

- **LIMIT BEEP** — Turns the audible limit beep indicator on or off.

SYS







Displays the System menu softkey selections.

- **OPTIONS** — Displays a second level of functions:
 - **UNITS** — Select the unit of measurement (English or metric).
 - **PRINTER** — Displays a menu of supported printers. Use the Up/Down arrow key and **ENTER** key to make the selection.
 - **FIXED CW** — Toggles the fixed CW function ON or OFF. When OFF, a narrow band of frequencies centered on the selected frequency is generated. When CW is ON, only the center frequency is generated. Output power is pulsed in all modes.
 - **CHANGE DATE FORMAT** — Toggles the date format between MM/DD/YY, DD/MM/YY, and YY/MM/DD.
 - **BACK** — Returns to the top-level SYS Menu.
- **CLOCK** — Displays a second level of functions:
 - **HOUR** — Enter the hour (0-23) using the Up/Down arrow key or the keypad. Press **ENTER** when data entry is complete or **ESCAPE** to restore the previous value.
 - **MINUTE** — Enter the minute (0-59) using the Up/Down arrow key or the keypad. Press **ENTER** when data entry is complete or **ESCAPE** to restore the previous value.
 - **MONTH** — Enter the month (1-12) using the Up/Down arrow key or the keypad. Press **ENTER** when data entry is complete or **ESCAPE** to restore the previous value.
 - **DAY** — Enter the day using the Up/Down arrow key or the keypad. Press **ENTER** when data entry is complete or **ESCAPE** to restore the previous value.
 - **YEAR** — Enter the year (1997-2036) using the Up/Down arrow key or the keypad. Press **ENTER** when data entry is complete or **ESCAPE** to restore the previous value.
 - **BACK** — Returns to the top-level SYS menu.
- **SELF TEST** — Start an instrument self test.
- **STATUS** — Displays the current instrument status, including calibration status, temperature, and battery charge state. Press **ESCAPE** to return to operation.
- **Language** — Pressing this soft key immediately changes the language used to display messages on the Site Master display. Choices are English, French, German, Spanish, Chinese, and Japanese. The default language is English.

Symbols

Table 2-1 provides a listing of the symbols used as condition indicators on the LCD display.

Table 2-1. LCD Icon Symbols

<u>Icon</u>	<u>Symbol</u>
	Site Master is in Hold for power conservation. To resume sweeping, press the RUN/HOLD key. After 10 minutes without a key press, the Site Master will automatically activate the power conservation mode.
	Integrator Failure. Intermittent integrator failure may be caused by interference from another antenna. Persistent integrator failure indicates a need to return the Site Master to the nearest Anritsu service center for repair.
	Lock fail indication. Check battery. (If the Site Master fails to lock with a fully charged battery, call your Anritsu Service Center.)
	When calibration is performed, the Site Master stores the ambient temperature. If the temperature drifts outside the specified range, this indicator will flash. A recalibration at the current temperature is recommended.
	Indicates the remaining charge on the battery. The inner white rectangle grows longer as the battery charge depletes.
	Indicates internal data processing.
CAL ON	The Site Master has been calibrated.
CAL ON!	The Site Master has been calibrated with the InstaCal Module.
CALL OFF	The Site Master has not been calibrated.

Self Test

At turn-on, the Site Master runs through a series of quick checks to ensure the system is functioning properly. Note that the battery voltage and temperature are displayed in the lower left corner below the self test message. If the battery is low, or if the ambient temperature is not within the specified operational range, Self Test will fail. If Self Test fails and the battery is fully charged and the Site Master is within the specified operating range, call your Anritsu Service Center.

Error Codes

Self Test Errors

A listing of Self Test Error messages is given in Table 2-2.

Table 2-2. Self Test Error Messages

<u>Error Message</u>	<u>Description</u>
BATTERY LOW	Battery voltage is less than 9.5 volts. Charge battery. <i>If condition persists, call your Anritsu Service Center.</i>
EXTERNAL POWER LOW	External supply voltage is less than 12.5 volts. <i>Call your Anritsu Service Center</i>
PLL FAILED	Phase-locked loops failed to lock. Charge battery. <i>If condition persists with a fully charged battery, call your Anritsu Service Center</i>
INTEGRATOR FAILED	Integration circuit could not charge to a valid level. Charge battery. <i>If condition persists with a fully charged battery, call your Anritsu Service Center.</i>
EEPROM R/W FAILED	Non-volatile memory system has failed. <i>Call your Anritsu Service Center.</i>
OUT OF TEMP. RANGE	Ambient temperature is not within the specified operating range. <i>If the temperature is within the specified operating range and the condition persists, call your Anritsu Service Center.</i>
RTC BATTERY LOW	The internal real-time clock battery is low. A low or drained clock battery will affect the date stamp on saved traces. <i>Contact your nearest Anritsu Service Center.</i>
LO LOCK FAIL	The local oscillator in the spectrum analyzer has phase lock loop errors. <i>If condition persists with a fully charged battery, call your Anritsu Service Center.</i>
POWER MONITOR FAIL	Failure of the power monitor system board voltages. <i>If condition persists, call your Anritsu Service Center.</i>
BATTERY CAL LOST	Battery communication failed. The indicated battery charge status may be invalid. <i>If condition persists, call your Anritsu Service Center.</i>
MEMORY FAIL	The EEPROM test on the Site Master main board has failed. <i>If condition persists, call your Anritsu Service Center.</i>
The time and date Have not been set on this Site Master. To set it, after exiting here press the <SYS> [CLOCK] keys. Press ENTER or ESC to continue	The time and date are not properly set in the Site Master. <i>If condition persists, call your Anritsu Service Center.</i>

Note: A listing of Anritsu Service Centers is provided in Table 1-2, page 1-8.

Range Errors

A listing of Range Error messages is given in Table 2-3.

Table 2-3. Range Error Messages (1 of 2)

<u>Error Message</u>	<u>Description</u>
RANGE ERROR:F1 > F2	The start (F1) frequency is greater than the stop (F2) frequency.
RANGE ERROR:D1 > D2	The start (D1) distance is greater than the stop (D2) distance.
RANGE ERROR:D2 > DMax=xx.x ft (m)	The stop distance (D2) exceeds the maximum unaliased range. This range is determined by the frequency span, number of points, and relative propagation velocity: $\text{Maximum Unaliased Range} = \frac{(1.5 \times 10^8)(dp - 1)(V_f)}{F2 - F1}$ <p>Where: <i>dp</i> is the number of data points (130, 259, or 517) <i>V_f</i> is the relative propagation velocity <i>F2</i> is the stop frequency in Hz <i>F1</i> is the start frequency in Hz <i>Maximum Unaliased Range</i> is in meters</p>
RANGE ERROR: TOP<=BOTTOM	The SWR scale parameter top value is less than or equal to its bottom value.
RANGE ERROR: TOP>=BOTTOM	The RL scale parameter top value is greater than or equal to its bottom value.
CAL INCOMPLETE	A complete open, short, and load calibration must be performed before calibration can be turned on.
DIST REQUIRES F1 < F2	Valid distance to fault plots require a non-zero frequency span.
DIST REQUIRES CAL	Distance-to-fault measurements cannot be performed with CAL OFF.
NO STORED SWEEP AT THIS LOCATION	Attempting to recall a display from a location that has not been previously written to. That is, the location does not contain stored sweep.
USE OPTIONS MENU TO SELECT A PRINTER	Attempting to print a display with no printer selected. Select a printer, then retry.
DISTANCE AND CABLE INSERTION LOSS MODE ARE INCOMPATIBLE	DTF measurements only display RL or SWR versus distance.

Table 2-3. Range Error Messages (2 of 2)

<u>Error Message</u>	<u>Description</u>
CANNOT ZERO NO DETECTOR INSTALLED	Attempting to perform a Power Monitor zero adjust function with no RF detector connected to the Site Master.
CANNOT ZERO INPUT SIGNAL TOO HIGH	Attempting to perform a Power Monitor zero adjust function with an input of greater than -20 dBm.
POWER MONITOR OPTION NOT INSTALLED	Attempting to enter Power Monitor mode with no Option 5 installed.

InstaCal Error Messages

If an InstaCal module that has not been characterized in more than one year is connected to the Site Master, the follow message will be displayed:

*The InstaCal Module Connected, S/N XXXXX
Was Characterized more than 1 year ago.
Characterization date
Current SiteMaster Date
You are advised to return this InstaCal module
to the factory for re-characterization.
Press ENTER to continue, see manual for details.*

Return the InstaCal module to the factory for re-characterization in order to ensure continued accurate measurements.

If the serial number of the connected InstaCal module does not match the serial number stored in the Site Master, the following message is displayed:

*The InstaCal characterization data stored in the SiteMaster
is for a module different than the one currently connected.
SiteMaster contains data for InstaCal module S/N:
Currently connected InstaCal Module S/N:
Would you like to overwrite the previously
loaded InstaCal characterization?*

Press the **YES** soft key to update the stored InstaCal characterization to use the currently connected module.

Press the **NO** soft key to keep the stored InstaCal characterization.

A listing of InstaCal error messages is given in Table 2-4.

Table 2-4. InstaCal Error Messages

<u>Error Message</u>	<u>Description</u>
FAILED TO READ SERIAL NUMBER OF INSTACAL MODULE	The Site Master was unable to read the InstaCal module serial number.
FAILED TO SUCCESSFULLY TRANSFER INSTACAL MODULE DATA TO SITE MASTER	The Site Master was unable to transfer all necessary data between the InstaCal module and the Site Master.
FAILED TO SET BAUD WITH INSTACAL MODULE	The Site Master was unable to establish communication with the InstaCal module.



Battery Information

Charging a New Battery

The NiMH battery supplied with the Site Master has already completed three charge and discharge cycles at the factory and full battery performance should be realized after your first charge.

NOTE: The battery will not charge if the battery temperature is above 45° C or below 0° C.

Charging the Battery in the Site Master

The battery can be charged while installed in the Site Master.

- Step 1.** Turn the Site Master off.
- Step 2.** Connect the AC-DC adapter (Anritsu part number: 40-115) to the Site Master charging port.
- Step 3.** Connect the AC adapter to a 120 VAC or 240 VAC power source as appropriate for your application.

The green external power indicator on the Site Master will illuminate, indicating the presence of external DC power and the battery will begin charging. The indicator will remain lit as long as the battery is charging. Once the battery is fully charged, the battery indicator will turn off. If the battery fails to charge, contact your nearest Anritsu service center.

Charging the Battery in the Optional Charger

Up to two batteries can be charged simultaneously in the optional battery charger.

- Step 1.** Remove the NiMH battery from your Site Master and place it in the optional charger (Anritsu part number 2000-1029).
- Step 2.** Connect the lead from the AC-DC adapter to the charger.
- Step 3.** Connect the AC-DC adapter to a 120 VAC or 240 VAC power source as appropriate for your application.

Each battery holder in the optional charger has an LED charging status indicator. The LED color changes as the battery is charged:

- Red indicates the battery is charging
- Green indicates the battery is fully charged
- Yellow indicates the battery is in a waiting state (see below).

A yellow light may occur because the battery became too warm during the charge cycle. The charger will allow the battery to cool off before continuing the charge. A yellow light may also indicate that the charger is alternating charge to each of the two batteries.

A blinking red light indicates less than 13 VDC is being supplied to the charger stand. Check that the correct AC charger adapter is connected to the charger stand. If the battery fails to charge, contact your nearest Anritsu Service Center.

The NiMH battery will last longer and perform better if allowed to completely discharge before recharging. For maximum battery life, it is recommended that the NiMH battery be completely discharged and recharged once every three months.

Battery Charge Indicator

When the AC-DC adapter is unplugged from the Site Master, the battery indicator symbol will be continuously displayed at the top left corner of the Site Master display (Figure 2-8).

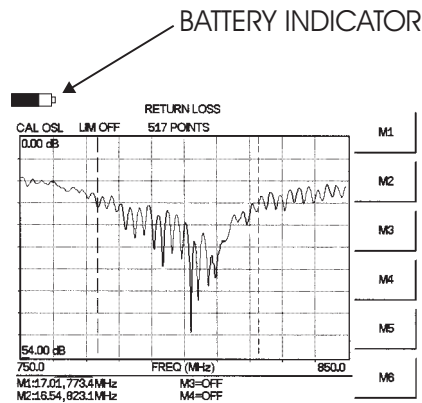

Figure 2-8. Site Master Battery Indicator

A totally black bar indicates a fully charged battery. When LOW BATT replaces the battery indicator bar at the top left corner, a couple of minutes of measurement time remains. If a flashing LOW BATT is accompanied by an audio beep at the end of each trace, the battery has approximately one minute of useable time remaining.

Once all the power has drained from the battery, the Site Master display will fade. At this point, your Site Master will switch itself off and the battery will need to be recharged.

Battery Life

It is normal for NiMH batteries to self-discharge during storage, and to degrade to 80% of original capacity after 12 months of continuous use.

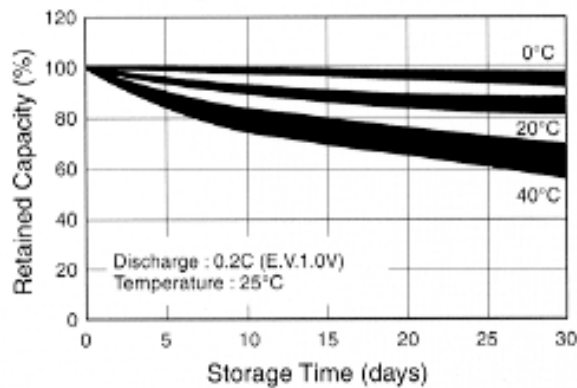

Figure 2-9. NiMH Battery Storage Characteristics

The battery can be charged and discharged 300 to 500 times, but it will eventually wear out. The battery may need to be replaced when the operating time between charging is noticeably shorter than normal.

Important Battery Information

- With a new NiMH battery, full performance is achieved after three to five complete charge and discharge cycles. The NiMH battery supplied with the Site Master has already completed three charge and discharge cycles at the factory.
- Recharge the battery only in the Site Master or in an Anritsu approved charger.
- When the Site Master or the charger is not in use, disconnect it from the power source.
- Do not charge batteries for longer than 24 hours; overcharging may shorten battery life.
- If left unused a fully charged battery will discharge itself over time. Storing the battery in extreme hot or cold places will reduce the capacity and lifetime of the battery. The battery will discharge faster at higher ambient temperatures.
- Discharge an NiMH battery from time to time to improve battery performance and battery life.
- The battery can be charged and discharged hundreds of times, but it will eventually wear out.
- The battery may need to be replaced when the operating time between charging is noticeably shorter than normal.
- Do not short-circuit the battery terminals.
- Do not drop, mutilate or attempt to disassemble the battery.
- Never use a damaged or worn out charger or battery.
- Always use the battery for its intended purpose only.
- Temperature extremes will affect the ability of the battery to charge: allow the battery to cool down or warm up as necessary before use or charging.
- Batteries must be recycled or disposed of properly. Do not place batteries in garbage.
- Do not dispose of batteries in a fire!

Chapter 3

Getting Started

Introduction

This chapter provides a brief overview of the Anritsu Site Master. The intent of this chapter is to provide the user with a starting point for making basic measurements.

Power On Procedure

The Anritsu Site Master is capable of up to 2.5 hours of continuous operation from a fully charged, field-replaceable battery. Built-in energy conservation features allow battery life to be extended over an eight-hour workday.

The Site Master can also be operated from a 12.5 Vdc source (which will also simultaneously charge the battery). This can be achieved with either the Anritsu AC-DC Adapter (P/N 40-115) or 12.5 Vdc Automotive Cigarette Lighter Adapter (P/N 806-62). Both items are included as standard accessories (see Chapter 1).

To power on the Site Master:

Step 1. Press the **ON/OFF** front panel key (Figure 3-1).

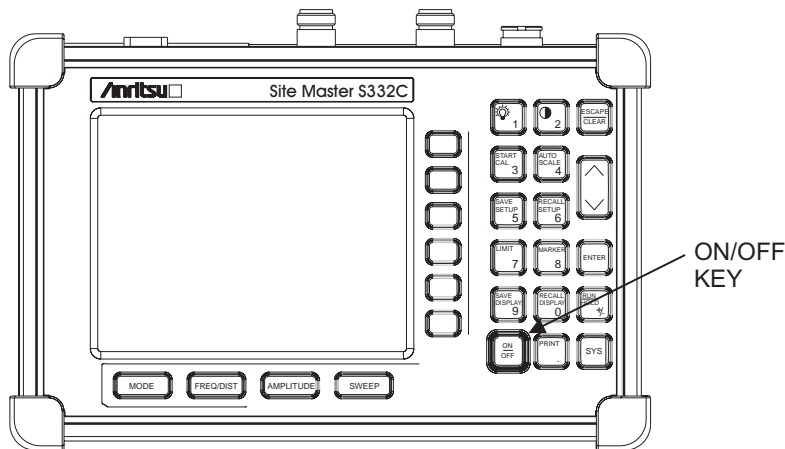

Figure 3-1. Site Master On/Off Key

The Site Master takes about five seconds to perform a series of self-diagnostic and adjustment routines. At completion, the screen displays the Anritsu logo, the model number, and the firmware version. The Site Master will continue after a 10 second timeout, or:

Step 2. Press **ENTER** to continue.

The Site Master is now ready for operation.

Select the Frequency or Distance

Regardless of the calibration method used, the frequency range for the desired measurements must be set before calibrating the Site Master. The following procedure selects the frequency range for the calibration.

- Step 1.** Press the **FREQ/DIST** key.
- Step 2.** Press the **F1** soft key.
- Step 3.** Enter the desired start frequency using the key pad or the Up/Down arrow key.
- Step 4.** Press **ENTER** to set F1 to the desired frequency.
- Step 5.** Press the **F2** soft key.
- Step 6.** Enter the desired stop frequency using the keypad or the Up/Down arrow key.
- Step 7.** Press **ENTER** to set F2 to the desired frequency.

Check that the start and stop frequencies displayed match the desired measurement range.

Calibration

For accurate results, the Site Master must be calibrated before making any measurements. The Site Master must be re-calibrated whenever the setup frequency changes, the temperature exceeds the calibration temperature range or when the test port extension cable is removed or replaced.

The Site Master may be calibrated manually with Open, Short, Load (OSL) calibration components, or by using the InstaCal module provided with the system.

If a Test Port Extension Cable is to be used, the Site Master must be calibrated with the Test Port Extension Cable in place. The Test Port Extension Cable is a phase stable cable and is used as an extension cable on the test port to ensure accurate and repeatable measurements. This phase stable cable can be moved and bent while making a measurement without causing errors in the measurement.

NOTE: The test port extension cable should have the appropriate connectors for the measurement. Use of additional connector adapters after the test port extension cable can contribute to measurement errors not compensated for during calibration.

Calibration Verification

During the calibration process in Return Loss mode, either with discrete calibration components or with the InstaCal module, there are typical measurement levels expected. Verifying the measurement levels displayed on the screen during calibration can save valuable time in the field.

Trace Characteristics in Return Loss Mode

As the discrete calibration components are connected to the Site Master RF out port, the following measurement levels will be displayed on the screen:

- ❑ When an OPEN is connected, a trace will be displayed between 0-10 dB.
- ❑ When a SHORT is connected, a trace will be displayed between 0-10 dB.
- ❑ When a LOAD is connected, a trace will be displayed between 0-50 dB.

When an InstaCal module is connected to the Site Master RF out port, the following measurement levels will be displayed on the screen:

- ❑ When the Site Master is measuring an equivalent OPEN, a trace will be displayed between 0-20 dB.
- ❑ When the Site Master is measuring an equivalent SHORT, a trace will be displayed between 0-20 dB.
- ❑ When the Site Master is measuring an equivalent LOAD, a trace will be displayed between 0-50 dB.

The following procedures explain Manual and InstaCal calibration methods. Refer to Figure 3-2 for a calibration setup diagram.



Manual Calibration Procedure

If the “CAL OFF” message is displayed, or the test port cable has been changed, a new calibration is required. The following procedure details how to perform the calibration.

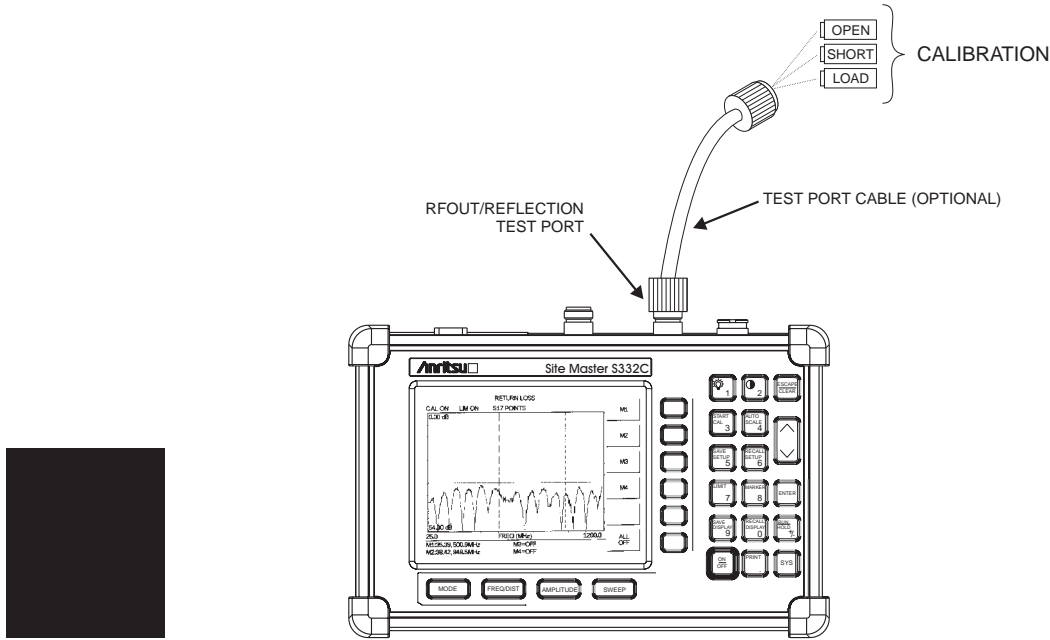

Figure 3-2. Calibration Setup

- Step 1.** Select the appropriate frequency range, as described in the procedure above.
- Step 2.** Press the **START CAL** key. The message “CONNECT OPEN or InstaCal TO RF Out PORT” will appear in the display.
- Step 3.** Connect the calibrated Open and press the **ENTER** key. The messages “Measuring OPEN” and “CONNECT SHORT TO RF Out” will appear.
- Step 4.** Remove the Open, connect the calibrated Short and press the **ENTER** key. The messages “Measuring SHORT” and “CONNECT LOAD TO RF Out” will appear.
- Step 5.** Remove the Short, connect the calibrated Termination and press the **ENTER** key. The messages “Measuring LOAD” will appear.
- Step 6.** Verify that the calibration has been properly performed by checking that the “CAL ON” message is now displayed in the upper left corner of the display.

InstaCal Module Verification

Verifying the InstaCal module before any line sweeping measurements is critical to the measured data. InstaCal module verification identifies any failures in the module due to circuitry damage or failure of the control circuitry. This test does not attempt to characterize the InstaCal module, which is performed at the factory or the service center.

The performance of the InstaCal module can be verified by the Termination method or the Offset method. The termination method is the preferred method in the field, and is similar to testing a bad load against a known good load.

Termination Method

The Termination method compares a precision load against the InstaCal Module and provides a baseline for other field measurements. A precision load provides better than 42 dB directivity.

- Step 1.** Set the frequency according to the device under test (cellular, PCS, GSM).
- Step 2.** Press the **MODE** key and select **FREQ-RETURN LOSS** mode.
- Step 3.** Connect the InstaCal module to the Site Master RF OUT port and calibrate the Site Master using the InstaCal module (page 3-6).
- Step 4.** Remove the InstaCal module from the RF OUT port and connect the precision load to the RF OUT port.
- Step 5.** Measure the return loss of the precision load. The level should be less than 35 dB across the calibrated frequency range.
- Step 6.** Press the **MARKER** key and set the M1 marker to **MARKER TO PEAK**. The M1 value should be less than 35 dB return loss.
- Step 7.** Press **SAVE DISPLAY** (page 3-8) name the trace, and press **ENTER**.

Offset Method

An alternative to the termination method is to measure the return loss of a 20 dB offset. This is similar to measuring an antenna that has been specified to have a 20 dB return loss across the frequency of operation. A 20 dB offset provides a 20 dB return loss across a very wide frequency range. Measuring the return loss with the 20 dB offset will provide a relatively flat response across the operating frequency range of the Site Master models (S113C, S114C, S331C, and S332C).

- Step 1.** Set the frequency according to the device under test (cellular, PCS, GSM).
- Step 2.** Press the **MODE** key and select **FREQ-RETURN LOSS** mode.
- Step 3.** Connect the InstaCal module to the Site Master RF OUT port and calibrate the Site Master using the InstaCal module (page 3-6).
- Step 4.** Remove the InstaCal module from the RF OUT port and connect the 20 dB Offset to the RF OUT port.
- Step 5.** Measure the return loss of the 20 dB Offset. The level should be 20 dB, ± 2 dB across the calibrated frequency range.
- Step 6.** Press the **MARKER** key and set the M1 marker to **MARKER TO PEAK**. The M1 value should be approximately 20 dB return loss.
- Step 7.** Press **SAVE DISPLAY** (page 3-8) name the trace, and press **ENTER**.

InstaCal Module Calibration Procedure

The InstaCal module automatically calibrates the Site Master using the OSL method.

NOTE: The InstaCal module is not a discrete calibration component and it can not be used at the top of the tower to perform line sweep measurements.

Check that the “CAL OFF” message is displayed in the upper left corner of the display. This indicates that the Site Master has not been calibrated. The following procedure details how to perform the calibration using the InstaCal module.

- Step 1.** Select the appropriate frequency range, as described in the procedure above.
- Step 2.** Press the **START CAL** key. The message “CONNECT OPEN or InstaCal TO RF Out PORT” will appear in the display.
- Step 3.** Connect the InstaCal module to the RF Out port.
- Step 4.** Press the **ENTER** key. The Site Master senses the InstaCal module and automatically calibrates the unit using the OSL procedure. The calibration should take about 45 seconds.
- Step 5.** Verify that the calibration has been properly performed by checking that the **CAL ON!** message is displayed in the upper left corner of the display.

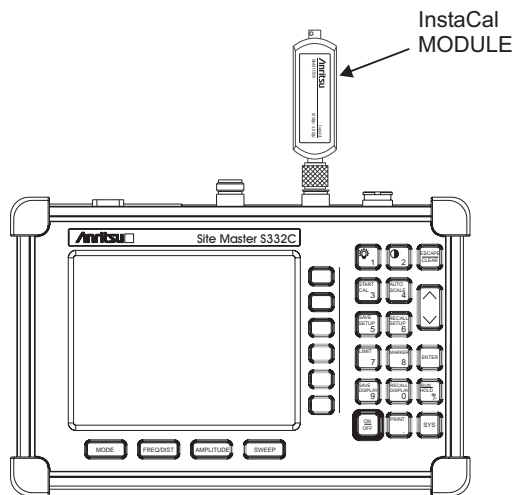

Figure 3-3. InstaCal Module Calibration

Calibration with the Test Port Extension Cable

If a Test Port Extension Cable is to be used, the Site Master must be calibrated with the Test Port Extension Cable in place. Follow the same calibration procedures as above with the OSL components or the InstaCal module in place at the end of the test port extension cable.

Setting the Scale

Auto Scale

The Site Master can automatically set the scales to the minimum and maximum values of the measurement on the y-axis of the display. This function is particularly useful for measurements in SWR mode. To automatically set the scales:

- Step 1.** Press the **AUTO SCALE** key.
The Site Master will automatically set the top and bottom scales to the minimum and maximum values of the measurement on the y-axis of the display.

Amplitude Scale

The following procedure sets the top and bottom scale display.

- Step 2.** Press the **AMPLITUDE** key to call up the Scale Menu.
- Step 3.** Press the **TOP** soft key and use the keypad or Up/Down arrow key to edit the top scale value.
- Step 4.** Press the **BOTTOM** soft key and use the keypad or Up/Down arrow key to edit the bottom scale value.

NOTE: Typically the y-axis scale of the display is 0-54 dB (return loss) but for some measurements (for example, insertion loss) the scale should be changed to 0-10 dB. If the scale is not changed, some measurement results may not be easily displayed on the screen.

Save and Recall a Setup

Saving a Setup

Saving a setup configuration in memory will preserve the calibration information.

- Step 1.** To save the configuration in one of the 10 available user setup locations, press **SAVE SETUP**.
- Step 2.** Use the key pad or the Up/Down arrow key to select a location (1 - 10).
- Step 3.** Press **ENTER** to save the setup.

NOTE: A manual calibration setup will be saved with an OSL designator. An InstaCal setup will be saved with an ICAL designation.

Recalling a Setup

The following procedure recalls a setup from memory.

- Step 1.** Press the **RECALL SETUP** key.
- Step 2.** Select the desired setup using the Up/Down arrow key.
- Step 3.** Press **ENTER** to recall the setup.

Save and Recall a Display

Saving a Display

The following procedure saves a display to memory.

- Step 1.** Press the **SAVE DISPLAY** key to activate the alphanumeric menu for trace storage.
- Step 2.** Use the soft keys to enter a label for the saved trace.

For example, to save a display with the name “TX1 RETURN LOSS” press the soft key group that contains the letter “T” then press the “T” soft key. Press the soft key group that contains the letter “X” then press the “X” soft key. Press the number “1” key on the numeric keypad. Use the softkeys and keypad as necessary to enter the entire name, then press **ENTER** to complete the process.



NOTE: More than one trace can be saved using the same alphanumeric name, as traces are stored chronologically, using the time/date stamp.

Recalling a Display

The following procedure recalls a previously saved display from memory.

- Step 1.** Press the **RECALL DISPLAY** key.
- Step 2.** Select the desired display using the Up/Down arrow key.
- Step 3.** Press **ENTER** to recall the display.

Set the Distance and Cable Type

In Distance-To-Fault (DTF) mode, the length of the transmission line (distance) and cable type are selected. The cable type determines the velocity propagation and cable attenuation factor. The following procedure can be used to set the distance and select the appropriate cable type.

NOTE: Selecting the correct cable is very important for accurate measurements and for identifying faults in the transmission line. Selecting the incorrect cable type will shift the DTF trace vertically and horizontally making it difficult to accurately locate faults.

- Step 1.** Press the **MODE** key.
- Step 2.** Select **DTF RETURN LOSS** or **DTF SWR** mode. The Site Master automatically sets D1 to zero.
- Step 3.** Press the **D2** soft key.
- Step 4.** Enter the appropriate D2 value for the maximum length of the transmission line and press the **ENTER** key to set the D2 value.
- Step 5.** Press the **DTF AID** soft key.
- Step 6.** Using the **Up/Down** arrow key, select **CABLE TYPE**. Standard cable types are stored in the Site Master cable list. This standard list may not be edited. A custom cable list can also be created.
- Step 7.** Using the **Up/Down** arrow key, select the appropriate list and select the type of cable. The selected cable type, PROP VEL and CABLE LOSS in dB/ft (or dB/m) will be displayed.
- Step 8.** Press **ENTER**.

Changing the Units

By default, the Site Master displays information in metric units. Use the following procedure to change the display to English units.

- Step 1.** Press the **SYS** key.
- Step 2.** Select the **OPTIONS** soft key.
- Step 3.** Press **UNITS** to change from metric to English measurement units, or vice versa. The current selection is displayed at the bottom left corner of the screen.

Changing the Display Language

By default, the Site Master displays messages in English. To change the display language:

- Step 1.** Press the **SYS** key.
- Step 2.** Select the **Language** soft key.
- Step 3.** Select the desired language. Choices are English, French, German, Spanish, Chinese, and Japanese. The default language is English.

Printing

Printing is accomplished by selecting an available printer and pressing the print key as described below. Refer to the particular printer operating manual for specific printer settings.

Printing a Screen

Step 1. Connect the printer as shown in Figure 3-4.

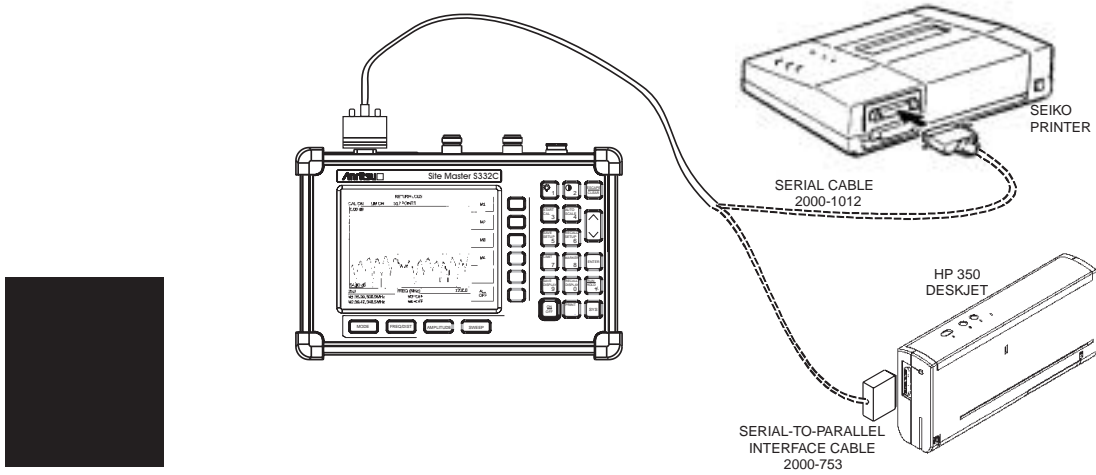

Figure 3-4-. Site Master Printer Setup

Step 2. Obtain the desired measurement display

Step 3. Press the **SYS** key and the **OPTIONS** soft key (Figure 3-5).

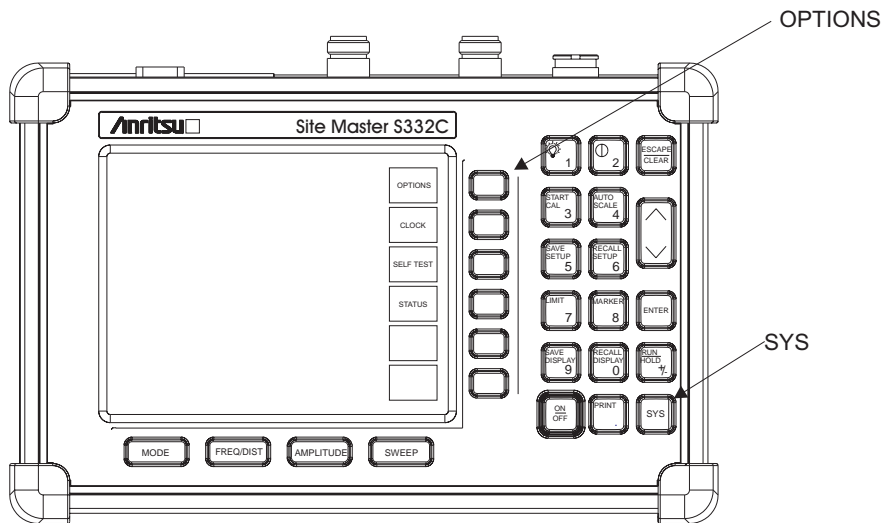

Figure 3-5-. SYS Key and OPTIONS Soft Key

- Step 4.** Press the **PRINTER** soft key and select from the displayed menu of supported printers.
- Step 5.** Press the **PRINT** key. (Figure 3-6).

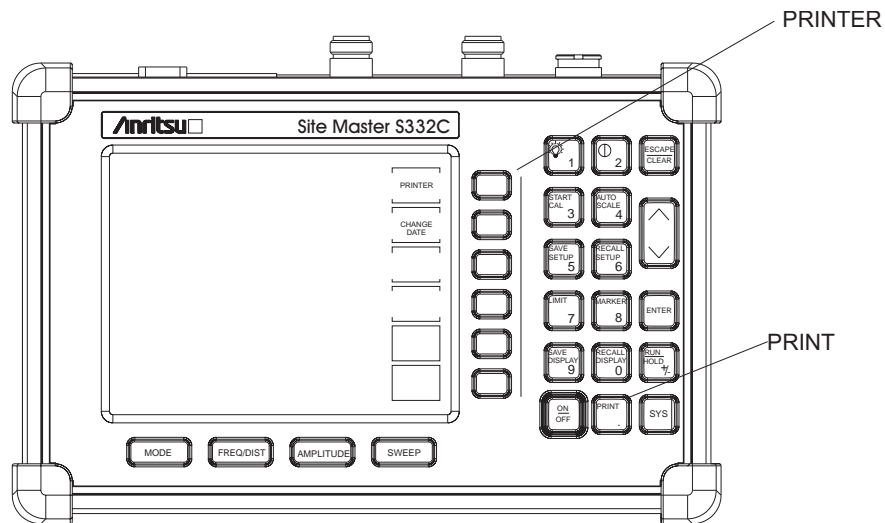

Figure 3-6-. PRINTER Soft Key and PRINT Key

Printer Switch Settings

Set the switches, SW1, SW2, and SW3, on the Seiko DPU-414 thermal printer as follows:

<u>Switch</u>	<u>1</u>	<u>2</u>	<u>3</u>	<u>4</u>	<u>5</u>	<u>6</u>	<u>7</u>	<u>8</u>
SW1	OFF	ON	ON	ON	ON	OFF	ON	ON
SW2	ON	ON	ON	ON	ON	ON	ON	OFF
SW3	ON	ON	ON	OFF	OFF	ON	ON	ON

Set the switches on the serial-to-parallel interface cable to the HP Deskjet 350 ink jet printer as follows:

<u>SW1</u>	<u>SW2</u>	<u>SW3</u>	<u>SW4</u>	<u>SW5</u>	<u>SW6</u>	<u>SW7</u>	<u>SW8</u>
OFF	ON	OFF	OFF	OFF	OFF	ON	OFF

Using the Soft Carrying Case

The soft carrying case has been designed such that the strap can be unsnapped to allow the case to be easily oriented horizontally; thus allowing the Anritsu controls to be more easily accessed (Figure 3-7).



Figure 3-7. Using the Site Master Soft Carrying Case

Chapter 4

Cable & Antenna Measurements

Introduction

This chapter provides a description of cable and antenna measurements, including line sweeping fundamentals and line sweeping measurement procedures, available when the Site Master is in frequency or DTF mode.

Line Sweep Fundamentals

In wireless communication, the transmit and receive antennas are connected to the radio through a transmission line. This transmission line is usually a coaxial cable or waveguide. This connection system is referred to as a transmission feed line system. Figure 4-1 shows an example of a typical transmission feed line system.

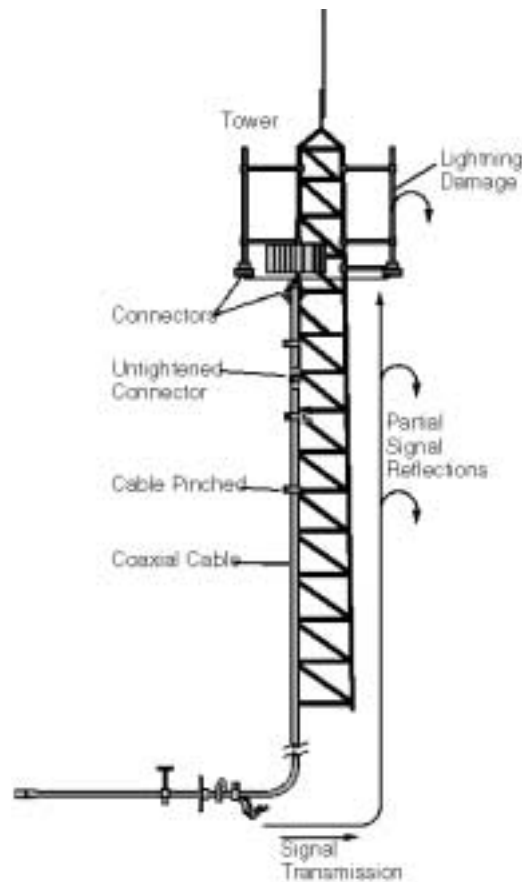

4

Figure 4-1. A Typical Transmission Feed Line System

The performance of a transmission feed line system may be effected by excessive signal reflection and cable loss. Signal reflection occurs when the RF signal reflects back due to an impedance mismatch or change in impedance caused by excessive kinking or bending of the transmission line. Cable loss is caused by attenuation of the signal as it passes through the transmission line and connectors.

To verify the performance of the transmission feed line system and analyze these problems, three types of line sweeps are required:

Return Loss Measurement—Measures the reflected power of the system in decibels (dB). This measurement can also be taken in the Voltage Standing Wave Ratio (VSWR) mode, which is the ratio of the transmitted power to the reflected power. However, the return loss measurement is typically used for most field applications.

Insertion Loss Measurement—Measures the energy absorbed, or lost, by the transmission line in dB/ft or dB/meter. Different transmission lines have different losses, and the loss is frequency and distance specific. The higher the frequency or longer the distance, the greater the loss.

Distance-To-Fault (DTF) Measurement—Reveals the precise fault location of components in the transmission line system. This test helps to identify specific problems in the system, such as connector transitions, jumpers, kinks in the cable or moisture intrusion.

The different measurements are defined as:

Return Loss - System Sweep—A measurement made when the antenna is connected at the end of the transmission line. This measurement provides an analysis of how the various components of the system are interacting and provides an aggregate return loss of the entire system.

Distance To Fault - Load Sweep—A measurement made with the antenna disconnected and replaced with a 50 Ω precision load at the end of the transmission line. This measurement allows analysis of the various components of the transmission feed line system in the DTF mode.

Cable Loss - Insertion Loss Sweep—A measurement made when a short is connected at the end of the transmission line. This condition allows analysis of the signal loss through the transmission line and identifies the problems in the system. High insertion loss in the feed line or jumpers can contribute to poor system performance and loss of coverage.

This whole process of measurements and testing the transmission line system is called Line Sweeping.

Information Required for a Line Sweep

The following information must be determined before attempting a line sweep measurement:

- System Frequency Range, to set the sweep frequency
- Cable Type, to set the cable characteristics for DTF measurements
- Distance of the Cable Run, to set the distance for DTF measurements

Typical Line Sweep Test Procedures

This section provides typical line sweep measurements used to analyze the performance of a transmission feed line system.

System Return Loss Measurement

System return loss measurement verifies the performance of the transmission feed line system with the antenna connected at the end of the transmission line. To measure the system return loss:

Required Equipment

- Site Master Model S113C, S114C, S331C, or S332C
- Precision Open/Short, Anritsu 22N50 *or*
Precision Open/Short/Load, Anritsu OSLN50LF
- Precision Load, Anritsu SM/PL
- Test Port Extension Cable, Anritsu 15NNF50-1.5C
- Optional 510-90 Adapter, DC to 7.5 GHz, 50 ohm, 7/16(F)-N(M)
- Anritsu InstaCal Module, ICN50

Device Under Test

- Transmission Feed Line with Antenna

Procedure

- Step 1.** Press the **MODE** key.
- Step 2.** Select **FREQ-RETURN LOSS** using the Up/Down arrow key and press **ENTER**.
- Step 3.** Set the start and stop frequencies, F1 and F2, as described on page 3-2.
- Step 4.** Calibrate the Site Master as described on page 3-2.
- Step 5.** Connect the Device Under Test to the Site Master. A trace will be displayed on the screen when the Site Master is in the sweep mode.
- Step 6.** Press **SAVE DISPLAY** (page 3-8) name the trace, and press **ENTER**.

NOTE: The antenna must be connected at the end of the transmission feed line when conducting a System Return Loss measurement.

Figure 4-2 is an example of a typical system return loss trace:

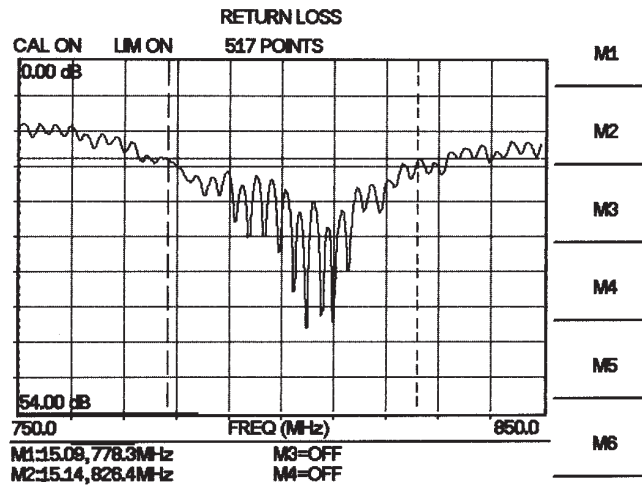

Figure 4-2. Typical System Return Loss Trace

NOTE: The system sweep trace should appear at an approximate return loss of 15 dB (± 3 dB) on the display. In general, a 15 dB return loss is measured in the passband of the antenna system.

Insertion Loss Measurement

The transmission feed line insertion loss test verifies the signal attenuation level of the cable system in reference to the specification. This test can be conducted with the Site Master in either **FREQ-CABLE LOSS** or **FREQ-RETURN LOSS** mode. In Cable Loss mode, the Site Master automatically considers the signal traveling in both directions when calculating the insertion loss, making the measurement easier for the user in the field. Both methods are explained below.

Required Equipment

- Site Master Model S113C, S114C, S331C, or S332C
- Precision Open/Short, Anritsu 22N50 *or*
Precision Open/Short/Load, Anritsu OSLN50LF
- Precision Load, Anritsu SM/PL
- Test Port Extension Cable, Anritsu 15NNF50-1.5C
- Optional 510-90 Adapter, DC to 7.5 GHz, 50 ohm, 7/16(F)-N(M)
- Anritsu InstaCal Module, ICN50

Device Under Test

- Transmission Feed Line with Short

Procedure - Cable Loss Mode

- Step 1.** Press the **MODE** key.
- Step 2.** Select **FREQ-CABLE LOSS** using the Up/Down arrow key and press **ENTER**.

- Step 3.** Set the start and stop frequencies, F1 and F2, as described on page 3-2.
- Step 4.** Connect the Test Port Extension cable to the RF port and calibrate the Site Master as described on page 3-2.
- Step 5.** Save the calibration set up (page 3-7).
- Step 6.** Connect the Device Under Test to the Site Master phase stable Test Port Extension cable. A trace will be displayed on the screen as long as the Site Master is in sweep mode.
- Step 7.** Press the **AMPLITUDE** key and set the **TOP** and **BOTTOM** values of the display. In the example below, the **TOP** is set to 2, and the **BOTTOM** is set to 5.
- Step 8.** Press the **MARKER** key.
- Step 9.** Set M1 to **MARKER TO PEAK**.
- Step 10.** Set M2 to **MARKER TO VALLEY**.
- Step 11.** Calculate the measured insertion loss by averaging M1 (marker to peak) and M2 (marker to valley) as follows:

$$Insertion\ Loss = \frac{M1 + M2}{2}$$

Step 12. Press **SAVE DISPLAY** (page 3-8) name the trace, and press **ENTER**.

Step 13. Verify the measured insertion loss against the calculated insertion loss. For example:

	Type	Attenuation (dB/ft)	× Length (ft)	= Loss (dB)
First Jumper	LDF4-50A	0.0325	20	0.65
Main Feeder	LDF5-50A	0.0186	150	2.79
Top Jumper	LDF4-50A	0.0325	10	0.325

Number of connector pairs (3) times the loss per pair (in dB) equals the connector loss: $3 \times 0.14 = 0.42$.

The insertion loss of the transmission system is equal to:

First Jumper loss + Main Feeder Loss + Top Jumper Loss + Connector Loss:

$$0.65 + 2.79 + 0.325 + 0.42 = 4.19\text{ dB}$$

Figure 4-3 is an example of a typical transmission line cable loss trace.

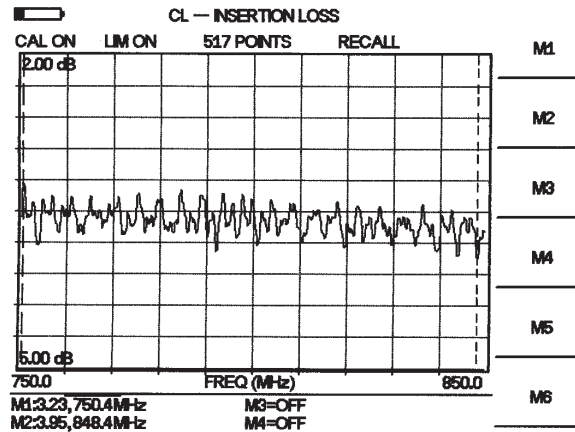

Figure 4-3. Typical Transmission Line Cable Loss Trace

Procedure - Return Loss Mode

- Step 1.** Press the **MODE** key.
- Step 2.** Select **FREQ-RETURN LOSS** using the Up/Down arrow key and press **ENTER**.
- Step 3.** Set the start and stop frequencies, F1 and F2, as described on page 3-2.
- Step 4.** Connect the Test Port Extension cable to the RF port and calibrate the Site Master as described on page 3-2.
- Step 5.** Save the calibration set up (page 3-7).
- Step 6.** Connect the Device Under Test to the Site Master phase stable Test Port Extension cable. A trace will be displayed on the screen as long as the Site Master is in sweep mode.
- Step 7.** Press the **AMPLITUDE** key and set **TOP** and **BOTTOM** values of the display. In the example below, the **TOP** is set to 4, and the **BOTTOM** is set to 10.
- Step 8.** Press the **MARKER** key.
- Step 9.** Set M1 to **MARKER TO PEAK**.
- Step 10.** Set M2 to **MARKER TO VALLEY**.
- Step 11.** Calculate the insertion loss by averaging M1 (marker to peak) and M2 (marker to valley) and dividing by two as follows:

$$\text{Insertion Loss} = \frac{M1 + M2}{2}$$

- Step 12.** Press **SAVE DISPLAY** (page 3-8) name the trace, and press **ENTER**.

Figure 4-4 is an example of a typical insertion loss measurement in return loss mode.

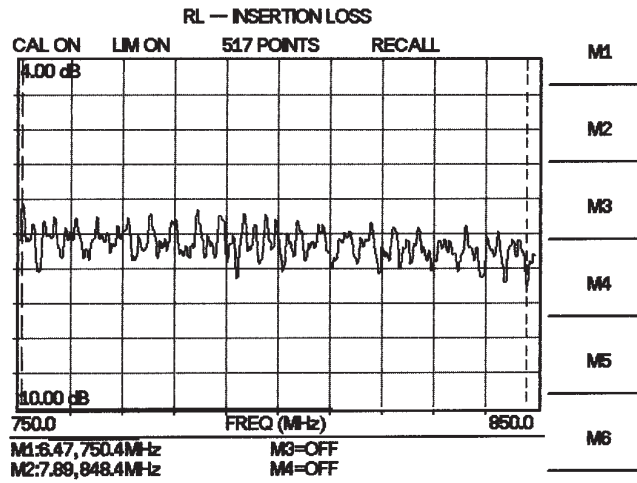

Figure 4-4. Typical Return Loss Trace



Distance-To-Fault (DTF) Transmission Line Test

The Distance-To-Fault transmission line test verifies the performance of the transmission line assembly and its components and identifies the fault locations in the transmission line system. This test determines the return loss value of each connector pair, cable component and cable to identify the problem location. This test can be performed in the DTF-RETURN LOSS or DTF-SWR mode. Typically, for field applications, the DTF-RETURN LOSS mode is used. To perform this test, disconnect the antenna and connect the load at the end of the transmission line.

Required Equipment

- ❑ Site Master Model S113C, S114C, S331C, or S332C
- ❑ Precision Open/Short, Anritsu 22N50 *or* Precision Open/Short/Load, Anritsu OSLN50LF
- ❑ Precision Load, Anritsu SM/PL
- ❑ Test Port Extension Cable, Anritsu 15NNF50-1.5C
- ❑ Optional 510-90 Adapter, DC to 7.5 GHz, 50 ohm, 7/16(F)-N(M)
- ❑ Anritsu InstaCal Module, ICN50

Device Under Test

- ❑ Transmission Feed Line with Load

Procedure - Return Loss Mode

The following steps explain how to make a DTF measurement in return loss mode.

- Step 1.** Press the **MODE** key.
- Step 2.** Select DTF-RETURN LOSS using the Up/Down arrow key and press **ENTER**.
- Step 3.** Connect the Test Port Extension cable to the RF port and calibrate the Site Master as described on page 3-2.
- Step 4.** Save the calibration set up (page 3-7).
- Step 5.** Connect the Device Under Test to the Site Master phase stable Test Port Extension cable. A trace will be displayed on the screen as long as the Site Master is in sweep mode.
- Step 6.** Press the **FREQ/DIST** key.
- Step 7.** Set the **D1** and **D2** values. The Site Master default for D1 is zero.
- Step 8.** Press the **DTF AID** soft key and select the appropriate **CABLE TYPE** to set the correct propagation velocity and attenuation factor.

NOTE: Selecting the right propagation velocity, attenuation factor and distance is very important for accurate measurements, otherwise the faults can not be identified accurately and insertion loss will be incorrect.

- Step 9.** Press **SAVE DISPLAY** (page 3-8) name the trace, and press **ENTER**.
- Step 10.** Record the connector transitions.

Figure 4-5 shows an example of a typical DTF return loss trace.

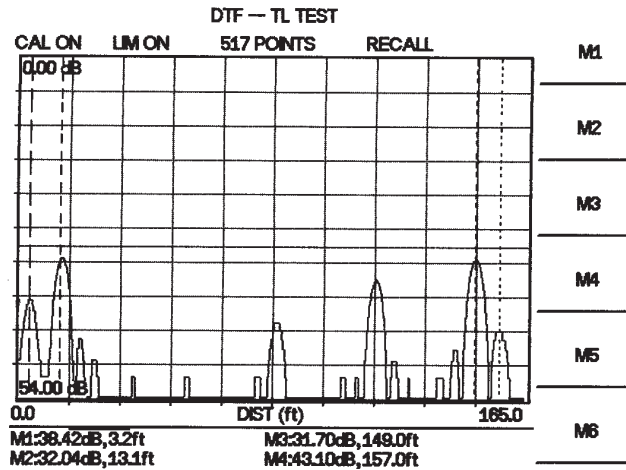

Figure 4-5. Typical DTF Return Loss Trace

In the above example:

- Marker M1 marks the first connector, the end of the Site Master phase stable Test Port Extension cable.
- Marker M2 marks the first jumper cable.
- Marker M3 marks the end of the main feeder cable.
- Marker M4 is the load at the end of the entire transmission line.

Procedure - DTF-SWR Mode

The following steps explain how to measure DTF in SWR mode.

- Step 1.** Press the **MODE** key.
- Step 2.** Select the **DTF-SWR** using the Up/Down arrow key and press **ENTER**.
- Step 3.** Follow the same procedure as DTF-Return Loss Mode, above.

Antenna Subsystem Return Loss Test

Antenna Subsystem return loss measurement verifies the performance of the transmit and receive antennas. This measurement can be used to analyze the performance of the antenna before installation. The antenna can be tested for the entire frequency band, or tested to a specific frequency range. Transmit and receive frequency measurements are conducted separately. The following steps explain how to measure the antenna loss in return loss mode.

Required Equipment

- Site Master Model S113C, S114C, S331C, or S332C
- Precision Open/Short, Anritsu 22N50 *or*
Precision Open/Short/Load, Anritsu OSLN50LF
- Precision Load, Anritsu SM/PL
- Test Port Extension Cable, Anritsu 15NNF50-1.5C
- Optional 510-90 Adapter, DC to 7.5 GHz, 50 ohm, 7/16(F)-N(M)
- Anritsu InstaCal Module, ICN50

Device Under Test

- Antenna Sub Assembly

Procedure

- Step 1.** Press the **MODE** key.
- Step 2.** Select **FREQ-RETURN LOSS** using the Up/Down arrow key and press **ENTER**.
- Step 3.** Connect the Test Port Extension cable to the RF port and calibrate the Site Master as described on page 3-2.
- Step 4.** Press **SAVE SETUP** and save the calibration set up (page 3-7).
- Step 5.** Connect the Device Under Test to the Site Master phase stable Test Port Extension cable.
- Step 6.** Press the **MARKER** key.
- Step 7.** Set markers M1 and M2 to the desired frequency.
- Step 8.** Record the lowest return loss over the specified frequency.
- Step 9.** Press **SAVE DISPLAY** (page 3-8) name the trace, and press **ENTER**.

The following trace is an example of an antenna return loss trace.

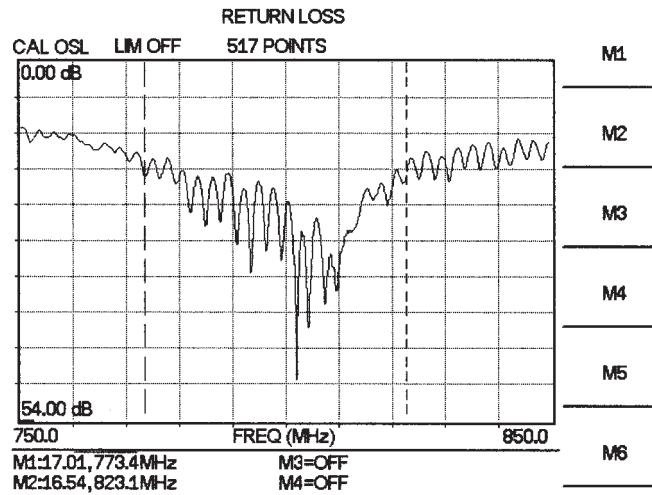

Figure 4-6. Antenna Return Loss Trace

Calculate the threshold value and compare the recorded Lowest Return Loss to the calculated threshold value.

$$\text{Maximum Return Loss} = \frac{-20 \log(VSWR - 1)}{(VSWR + 1)}$$

NOTE: VSWR is the antenna manufacturer's specified VSWR.

If the measured return loss is less than the calculated threshold value, the test fails and the antenna must be replaced.



Chapter 5

Spectrum Analyzer

Measurements

Introduction

This chapter provides a description of field measurements available when the Model S114C or S332C Site Master is in Spectrum Analyzer mode.

Occupied Bandwidth

A common measurement performed on radio transmitters is that of occupied bandwidth (OBW). This measurement calculates the bandwidth containing the total integrated power occupied in a given signal bandwidth. There are two different methods of calculation depending on the technique to modulate the carrier.

- ❑ **99% Method** — The occupied frequency bandwidth is calculated as the bandwidth containing 99% of the transmitted power.
- ❑ **X dB Down Method** — The occupied frequency bandwidth is defined as the bandwidth between the upper and lower frequency points at which the signal level is X dB below the peak carrier level.

Required Equipment

- ❑ Site Master Model S114C or S332C
- ❑ 30 dB, 50 Watt, bi-directional, DC –18 GHz, N(m) – N(f), Attenuator, 42N50A-30
- ❑ Test Port extension cable, Anritsu 15NNF50 – 1.5C

Procedure

- Step 1.** Using the test port extension cable and 30 dB attenuator connect the Site Master to the RF_Out test port.
- Step 2.** Press the **ON/OFF** key on the Site Master.
- Step 3.** Press the **MODE** key.
- Step 4.** Use the Up/Down arrow key to select the Spectrum Analyzer mode and press **ENTER**.
- Step 5.** Enter the center frequency of the measurement.
- Step 6.** Select the appropriate frequency span, reference level, input attenuation level, resolution bandwidth, and video bandwidth.
- Step 7.** Press the **MEAS** key.
- Step 8.** Press the **OBW** soft key.
- Step 9.** Select measurement method, % or dBc down by pressing the corresponding soft key and press **ENTER**.



Step 10. Press the **MEAS** key to initiate actual measurement. The Site Master will display the measurement results in the display area.
The Site Master default value for the % method is 99%, and N dBc down is 3 dB down.

The table below provides typical instrument settings for measuring a CW and an IS-95 CDMA signal.

Table 5-1. Typical Occupied Bandwidth Measurement Settings

	<u>CW Wave</u>	<u>IS-95 CDMA Signal</u>
Frequency Span	900 MHz	900 MHz
Reference Level	-15 dBm	-10 dBm
Input Attenuation Level	Auto	Auto
Resolution Bandwidth	Auto	10 kHz
Video Bandwidth	Auto	30 kHz

Channel Power Measurement

One of the most common measurements for a transmitter is that of channel power. This test measures the output power, or channel power, of a transmitter over a frequency range and a specific time interval. Channel Power measurements are used to validate transmitter performance, verify compliance with FCC regulations, and keep overall system interference at a minimum.

Out-of-specification power measurements indicate system faults in the power amplifier or in-filter circuits.

Channel Power Measurement with the Site Master

The Site Master can be used to measure CDMA signals in terms of channel power. It is necessary to use precise and specific settings to accurately measure the CDMA signal because the CDMA is different from CW signals.

For accurate IS-95 CDMA measurements, use the following settings:

- CDMA Channel Bandwidth: 1.23 MHz
- RBW setting: 10 kHz
- VBW $\geq 3 \times$ RBW or at least 30 kHz
- Averaging function turned off

Required Equipment

- Site Master Model S114C or S332C
- 30 dB, 50 Watt, bi-directional, DC –18 GHz, N(m) – N(f), Attenuator
- Test Port extension cable, Anritsu 15NNF50 – 1.5C

Procedure

Using the test port extension cable and 30 dB attenuator, connect the Site Master to the RF_IN test port. The measurement can be accomplished with or without the 30 dB attenuator. The attenuator is recommended for additional protection.

- Step 1.** Press the **ON/OFF** key on the Site Master.
- Step 2.** Press the **MODE** key.
- Step 3.** Use the Up/Down arrow key to select the Spectrum Analyzer mode and press **ENTER**.
- Step 4.** Enter the following control settings:
 - reference level = -15 dBm
 - Scale = 10 dB/division
 - RBW = 10 kHz
 - VBW = 30 kHz or greater
 - Span = 2.5 MHz
- Step 5.** Press the **MEAS** key.
- Step 6.** Once in the MEAS menu, press the **CHANNEL POWER** soft key.
- Step 7.** Select the center frequency by pressing the **CENTER FREQ** soft key and enter 900 MHz as the center frequency of the CDMA signal.
- Step 8.** Select the integration bandwidth by pressing the **INT BW** soft key and enter 1.23 MHz for the integration bandwidth.
- Step 9.** Select channel span by pressing the **CHANNEL SPAN** soft key and enter 1.23 MHz as the desired integration bandwidth.
- Step 10.** Make the measurement by pressing the **MEASURE** soft key. The Site Master will display the measurement results in the display area.

Integration bandwidth is defined as the frequency span in which the spectrum analyzer integrates measured power readings.

Channel span is the frequency range the analyzer sweeps. Channel span must be set to equal or greater than the integration bandwidth, or the Site Master will by default set the channel span equal to the integration span. The Site Master also keeps the ratio of the integration bandwidth to channel span constant. For example, if the channel span is doubled, the Site Master will double the integration span.

When the integration bandwidth and channel span are set to the same value, the Site Master provides the most accurate measurement, as it uses all the sampling points for integration.

Adjacent Channel Power Measurement

Another common transmitter measurement is that of adjacent channel power ratio. This is defined as the ratio of the amount of leakage power in an adjacent channel to the total transmitted power in the main channel. The current trend is to use this measurement to replace the traditional two-tone intermodulation distortion (IMD) test for system non-linear behavior.

The specification for ACPR requires comparing the power in the RF channel to the power at several offset frequencies. The result can be expressed either in power ratio or power density. In order to calculate the upper and lower adjacent channel values, the Site Master requires four parameters:

- Main channel center frequency
- Main channel bandwidth
- Adjacent channel bandwidth
- Channel spacing

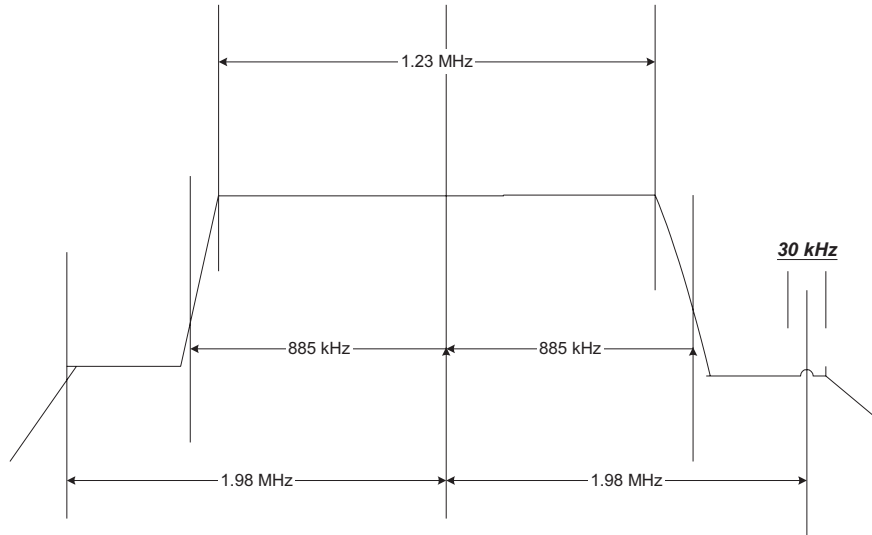

Figure 5-1. Example ACPR Specification

Required Equipment

- Site Master Model S114C or S332C
- 30 dB, 50 Watt, bi-directional, DC –18 GHz, N(m) – N(f), Attenuator
- Test Port extension cable, Anritsu 15NNF50 – 1.5C

Procedure

- Step 1.** Using the test port extension cable and 30 dB attenuator connect the Site Master to the appropriate transmitter test port. The measurement can be accomplished with or without the 30 dB attenuator. The attenuator is recommended for additional protection.
- Step 2.** Press the **ON/OFF** key on the Site Master.

- Step 3.** Press the **MODE** key.
- Step 4.** Use the Up/Down arrow key to select the Spectrum Analyzer mode and press **ENTER**.
- Step 5.** Select the appropriate reference level, input attenuation level, resolution bandwidth, and video bandwidth.
- Step 6.** Press the **MEAS** key.
- Step 7.** Once in the MEAS menu, press the **ACP** soft key.
- Step 8.** Select the center frequency by pressing the **CENTER FREQ** soft key and enter the desired center frequency.
- Step 9.** Select the main channel bandwidth by pressing the **MAIN CHANNEL BW** soft key and enter the desired main channel bandwidth. For an IS-95 signal enter 1.23 MHz.
- Step 10.** Select the adjacent channel bandwidth by pressing the **ADJ CHANNEL BW** soft key and enter the desired adjacent channel bandwidth. For an IS-95 signal enter 30 kHz.
- Step 11.** Select the channel spacing by pressing the **CHANNEL SPACING** soft key and enter the desired channel spacing. For an IS-95 signal, enter 885 or 1.98 MHz.
- Step 12.** Make the measurement by pressing the **MEASURE** soft key. The Site Master will display the measurement results in the display area.

The table below provides typical settings for measuring a CW and a IS-95 CDMA signal.

Table 5-2. ACPR Measurement Settings

	<u>CW Wave</u>	<u>IS-95 CDMA Signal</u>
Reference Level	-15 dBm	-10 dBm
Input Attenuation Level	Auto	Auto
Resolution Bandwidth	Auto	10 kHz
Video Bandwidth	Auto	30 kHz

Out-of-Band Spurious Emission Measurements

Out-of-band spurious measurements are made on signals outside the system main band. These signals, which can interfere with other communication systems, can be categorized into harmonics and random spurious emissions. Real time monitoring of spurious emissions from a transmitter can uncover unwanted signals before they interfere with other users on the other channels.

Required Equipment

- ❑ Site Master Model S114C or S332C
- ❑ 30 dB, 50 Watt, bi-directional, DC –18 GHz, N(m) – N(f), Attenuator, 42N50A-30
- ❑ Test Port extension cable, Anritsu 15NNF50 – 1.5C

Procedure

- Step 1.** Using the test port extension cable and 30 dB attenuator connect the Site Master to appropriate transmit test port.
- Step 2.** Press the **ON/OFF** key on the Site Master.
- Step 3.** Press the **MODE** key.
- Step 4.** Use the Up/Down arrow key to select the Spectrum Analyzer mode and press **ENTER**.
- Step 5.** Select the center frequency for the channel of interest.
- Step 6.** Set the frequency span wide enough to include the primary channel and upper and lower channel.
- Step 7.** Set the following parameters:
 - reference level = 0 dBm
 - input attenuation level = auto
 - resolution bandwidth =10 kHz
 - video bandwidth =300 Hz.
- Step 8.** Use the limit line and markers to read and compare the observed signals to the specified allowable level of out-of-band spurious emissions for the corresponding channel transmitted frequency.



In-Band/Out-of-Channel Measurements

The in-band/out-of-channel measurements are those measurements that measure distortion and interference within the system band, but outside of the transmitting channel. These measurements include in-band spurious emissions and adjacent channel power ratio (also known as spectral regrowth). There are stringent regulatory controls on the amount of interference that a transmitter can spill to neighboring channels. In order to determine compliance with the allowable level of spurious emissions, the spectrum analyzer needs two parameters to be specified:

- ❑ Measurement channel bandwidth
- ❑ Allowable level of spurious emissions.

Required Equipment

- ❑ Site Master Model S114C or S332C
- ❑ 30 dB, 50 Watt, bi-directional, DC –18 GHz, N(m) – N(f), Attenuator
- ❑ Test Port extension cable, Anritsu 15NNF50 – 1.5C

Procedure

- Step 1.** Using the test port extension cable and 30 dB attenuator connect the Site Master to appropriate transmit test port.
- Step 2.** Press the **ON/OFF** key on the Site Master.
- Step 3.** Press the **MODE** key.
- Step 4.** Use the Up/Down arrow key to select the Spectrum Analyzer mode and press **ENTER**.
- Step 5.** Select the center frequency for the channel of interest.
- Step 6.** Set the frequency span wide enough to include the primary channel and upper and lower channel.
- Step 7.** Set the following parameters as specified:
 - reference level = 0 dBm
 - input attenuation level = auto
 - resolution bandwidth =10 kHz
 - video bandwidth =300 Hz
- Step 8.** Use the limit line and markers to read and compare observed signals to the specified allowable level of in-band spurious emissions for the corresponding channel transmitted frequency.

NOTE: The resolution bandwidth of a spectrum analyzer is determined by the intermediate frequency (IF) filter bandwidth. Site Master, as do conventional spectrum analyzers, traces the shape of the IF filter as it sweeps past a signal. Therefore, if two equal-amplitude signals are very close to each other, the measurement result can appear to be one single response because the IF or resolution bandwidth is not small enough to resolve the two signals. Similarly, if two signals are not equal in amplitude but are very close together, the smaller signal may not be seen because it is hidden under the large response.

Field Strength Measurement

The procedure below details steps required making a field strength measurement with the Site Master.

Required Equipment

- ❑ Site Master Model S114C or S332C with tracking generator option
- ❑ Antenna of your choice

Procedure

- Step 1.** Press the **ON/OFF** key on the Site Master.
- Step 2.** Use the antenna editor feature of the Site Master Software Tools to define an antenna.
- Step 3.** Upload the antenna information to the Site Master.
- Step 4.** Press the **MEAS** key.
- Step 5.** Select the **FIELD STRENGTH** soft key.
- Step 6.** Press the **SELECT ANTENNA** soft key.
- Step 7.** Use the Up/Down arrow key to choose the desired antenna and then press the **ENTER** key
- Step 8.** To change the unit of measurement, press the **AMPLITUDE** hard key, and then press the **UNITS** soft key to select dB, dBV, dBmV or dB μ V.

The Site Master will automatically scale the display by the antenna factors selected.



Antenna Calculations

The following is a list of various antenna calculations should you find it necessary to convert from one to another:

Conversion of signal levels from mW to μV in a 50-ohm system:

$$P = \frac{V^2}{R}$$

where: P = power in Watts
V = voltage level in Volts
R = resistance in Ohms

For power in milliwatts (10^{-3}W), and voltage in microvolts (10^{-6}V):

$$V_{dB(\mu V)} = P(dBm) + 107$$

Power density to field strength. An alternate measure of field strength to electric field is power density:

$$Pd = \frac{E^2}{120\pi}$$

where: E = field strength in V/m
P = Power density in W/m^2

Power density at a point:

$$Pd = \frac{P_t G_t}{4\pi r^2}$$

In the far field, where electric and magnetic fields are related by the impedance of free space:

P_d = power density in W/m^2
 P_t = power transmitted in Watts
 G_t = gain of transmitting antenna
r = distance from the antenna in meters





Chapter 6

Power Measurement

Introduction

The Site Master with Option 5 installed can be used for making power measurements with a broadband (1 MHz to 3000 MHz) RF detector, Anritsu P/N 5400-71N50. The power monitor displays the measured power results in dBm or Watts.

Power Measurement

Required Equipment

- ❑ Site Master Model S114C or S332C with Power Monitor option
- ❑ Broadband RF detector, Anritsu P/N 5400-71N50
- ❑ 30 dB, 50 Watt, bi-directional, DC –18 GHz, N(m) – N(f), Attenuator, 42N50A-30

Procedure

- Step 1.** Press the **ON/OFF** key on the Site Master.
- Step 2.** Press the **MODE** key.
- Step 3.** Use the Up/Down arrow key to select the Power Monitor mode and press **ENTER**.

Zeroing the Power Monitor

- Step 4.** With no power applied to the DUT, press the **ZERO** soft key from the Power menu. Wait for a few seconds while the Site Master accumulates data samples of the quiescent power. When complete, **ZERO ADJ: On** is displayed in the message area.

Measuring High Input Power Levels

- Step 5.** Insert an attenuator between the DUT and the RF detector to protect the Site Master so that the input power level is less than or equal to 20 dBm.
- Step 6.** Press the **OFFSET** soft key.
- Step 7.** Enter the attenuation in dB using the keypad. Press the **ENTER** key to complete the entry. The message area will show **REL: ON** along with the entered value in dB.

Displaying Power in dBm and Watts

- Step 8.** Press the **UNITS** soft key to display power in Watts.

Displaying Relative Power

- Step 9.** With the desired base power level input to the Site Master, press the **REL** soft key. The message area will show **REL: ON** and the power reading will indicate 100%.
- Step 10.** Press the **UNITS** soft key to display power in dBm. Since REL is ON, the power reading will be in dB_r, relative to the base power level.



Chapter 7

Site Master Software Tools

Introduction

This chapter provides a description of the Site Master Software Tools provided with the Site Master. Site Master Software Tools (SMST) is a Windows 95/98/2000/ME/NT4 program for cable and antenna trace analysis. The program help function provides on screen instructions on display modification, trace overlay, and multiple plot printing.

Features

Site Master Software Tools provides the following features:

- Download traces saved in the Site Master memory to the PC for storage and analysis
- DTF and Smith Chart analysis capability
- Trace Overlay allows the viewing of two plots simultaneously
- Ability to save captured plots as data files (.dat file format) or as records representing site information in a database file
- Ability to convert Return Loss measurements to Distance-To-Fault measurements
- Ability to zoom in or out to analyze a particular region of the plot
- Ability to modify Plot Properties
- Ability to output plots to a printer for hard copy records
- Capture of the current trace in the unit

System Requirements

The Site Master Software Tools program will run on most any computer running Windows 95/98/2000/ME/NT4. Minimum requirements and recommendations are:

- Intel Pentium 100 MHz microprocessor (Pentium II 350 MHz or better recommended)
- 16 MB of RAM (64 MB or above recommended)
- Hard disk drive with approximately 15 MB of available space (An additional 20 MB free space for storage of captured plots is recommended.)
- A serial (COM) port for communication with the Site Master

NOTE: It is recommended that Windows NT 4.0 users install NT 4.0 Service Pack 3 (SP3) or above. In addition, Windows 2000 and Windows ME may require installation of the latest Service Pack. Please contact Microsoft Corporation for further information on obtaining and installing service packs.

7

Installation

To install the Site Master Software Tools program:

- Step 1.** Insert the Anritsu Site Master Software Tools disk in the CDROM drive.
- Step 2.** From the Windows Start menu, select **Run** .
- Step 3.** Type: **X:\Setup.exe** where X is the drive letter of your CDROM drive.
- Step 4.** When prompted, press the **Enter** key to accept the default directory C:\Program Files\Site Master Software Tools and the installation will begin.
- Step 5.** When the installation is complete, press **Enter** to restart Windows.

The *readme.doc* file on the disk provides updated information about the program, and the Help function provides detailed operating information.

Communication Port Setting

The Site Master Software Tools communicates with the Site Master through a standard serial COM port on the PC. Set the baud rate of the COM port to 115200.

- Step 1.** Select **Start, Programs** and select **Site Master Software Tools**.
- Step 2.** When the program has loaded, select **Settings, Communication**.
- Step 3.** Select the appropriate PC COM port and Transfer Baud Rate for your system, and click **OK**.



Figure 7-1. Communication Setting Dialog Box

Interface Cable Installation

Communication between the Site Master and the PC is accomplished over a null modem serial cable provided with the Site Master (Anritsu part number 800-441).

- Step 1.** Install the null modem serial interface cable to the Serial Interface connector on the Site Master Test Connector Panel.
- Step 2.** Connect the other end of the serial interface cable to the appropriate COM port connector on the PC.
- Step 3.** Turn on both the Site Master and the PC.

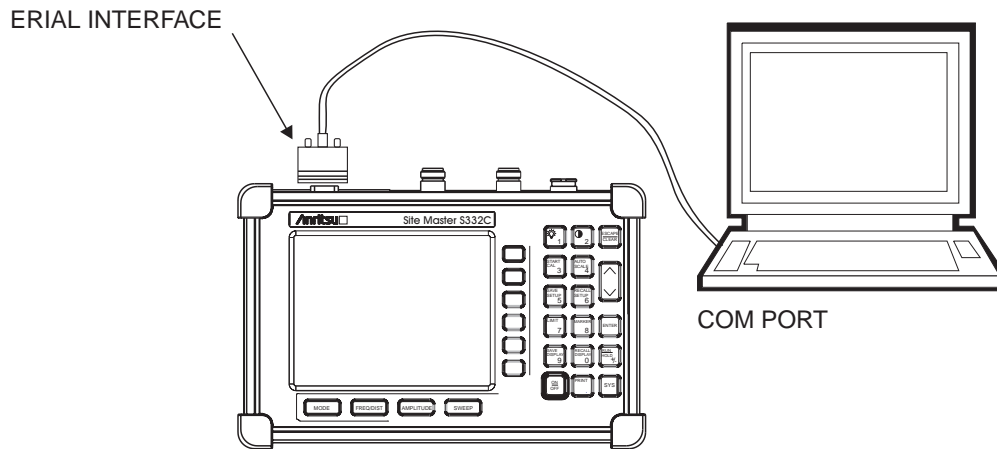

Figure 7-2. Serial Cable Connection

Using Software Tools

Select **Start, Programs** and select **Site Master Software Tools**.

If the proper command was sent to the Site Master from the PC a “remote” status will be displayed on the Site Master display.

Downloading Traces from the Site Master

Downloaded traces from the Site Master can be selected as a entire block or as individual files. Files are categorized by measurement type:

- Return Loss
- VSWR
- DTF (Distance-to-Fault)
- Time/Date stamp
- SPA Traces with ACPR and CP



Plot Capture

To open the plot capture menus, select the capture icon on the button bar, or select the **Capture** drop down menu from the menu bar.

Select **Capture to Screen** to download traces to the PC.

Highlight a folder, or highlight individual traces within a folder, to be downloaded to the PC. The traces will appear on the PC display as they are downloaded.

Plot Properties

After downloading, certain plot properties and information can be modified. Select the Plot Properties or Plot Information icon.

Plot Properties that can be changed include:

- Graph Titles
- Display Mode
- Scale/Limit
- Markers
- Misc.

Graph Titles

After downloading the plot, the **Main Title** can be changed to reflect the site name or other descriptive information. The **Sub Title** field can be used to describe the specifics of the measurement and configuration.

Display Mode

Display Mode allows changing the display type without having to retest. Plots can be changed from **Return Loss** to **VSWR** with single click of mouse button.

Scale/Limit

The scale of the displayed plot can be modified to help analyze whether the plot meets pass/fail criteria. The Scale/Limit sub menu activates options to manually enter the scale limits, or to use the Auto Scale mode.

Manual adjustment sets the upper and lower limits of the display under the Scale/Limit Submenu.

Auto Scale automatically adjusts the scale for maximum and minimum measurement readings.

Limit Line Off turns off all limit lines.

Single Limit Line can be activated to help identify faults. Typical antenna specifications require better than -15 dB return loss.

Multi-Segment Limit Lines can be activated to set different limits within the same measurement display for specification requirements.



Markers

Markers M1 through M6 can be activated from the Plot Properties menu.

The six active markers can be displayed on the plot to help identify faults from the line sweep data.

Misc.

The Miscellaneous tab allows adjustment of the Plot/Limit Line Width and the setting of the Plot Footer.

Plot/Limit Line Width can be used when preparing reports for the carrier, service providers, and network operators where the trace data must be visible and legible for documentation. The line density of the trace can be set to **Normal (Thin Line)** or **Thick Line** to make the data appear easily when copies are made.

Plot Footer allows selection of information to be displayed in the trace display. Selections are:

- | | |
|--|--|
| <input type="checkbox"/> Bias Tee | <input type="checkbox"/> Impedance |
| <input type="checkbox"/> Time/Date | <input type="checkbox"/> Measurements |
| <input type="checkbox"/> Model and Serial Number | <input type="checkbox"/> DTF Parameters |
| <input type="checkbox"/> Date Format | <input type="checkbox"/> Overlay Indicator |

Trace Overlay or Plot Overlay

Trace Overlay is activated by the Mouse Function icon. Single-click on the Mouse Function icon to toggle. Toggling this icon switches the mouse function between Marker/Limit/Zoom and Plot Overlaying.

To overlay two plots, click-and-drag from one plot to the other plot. The final display will be the two plots superimposed on one another.

Refer to the SMST **HELP** function for more information on the steps necessary to perform a trace overlay.

Saving Traces

Once the plots are captured to the PC they can be saved as individual files or as a block of files to a database.

Saving a Plot as a Windows Metafile or to a Spreadsheet

Plots can be saved as a Windows metafile (.wmf) or as a text file (.txt). The metafile may be imported into graphic programs and the text file can be imported into spreadsheet.

To save a plot as a Windows metafile, click on the **File** menu and select **Save as Metafile** from the pull down menu. Once the trace is saved as a metafile, it can be copied and transferred into other applications as a picture or graphic file.

To copy a metafile:

- Step 1.** Select the trace to be copied with the mouse cursor.
- Step 2.** Select **Edit** and then **Copy**. The file will copied to clipboard.



- Step 3.** Exit the Site Master Software Tools program and open the target application (Microsoft Word, etc.).
- Step 4.** Select **Edit** and then **Paste**. The file will be inserted as a low-resolution graphic file or a bitmap.

Saving a Plot to a Spreadsheet

Plots can be saved as a text file (.txt) which can then be imported into a spreadsheet program.

To save a plot as a text file:

- Step 1.** Select the trace to be copied with the mouse cursor.
- Step 2.** Click on the **File** menu and select **Export to Text File for a Spreadsheet** from the pull down menu.
- Step 3.** Save the file to a local directory.
- Step 4.** Exit the Site Master Software Tools program and open the spreadsheet application.
- Step 5.** Import the .txt file into the spreadsheet program.

Custom Cable List

A custom cable list can be created in Site Master Software Tools and uploaded to the Site Master. Some standard 1000 MHz, 2000 MHz, and 2500 MHz cables are stored in the Site Master and are listed in Appendix A of this User's Guide.

The cable list contains vital information such as propagation velocity, V_p and insertion loss (dB/m or dB/ft). These parameters are important when identifying faults and discontinuities of transmission lines.

NOTE: Values for the cable list are taken from manufacturers specifications and are normalized for a sweep frequency setting of 1 GHz. Complex digital communications systems may require adjustment to attenuation values at the higher frequencies. Contact the manufacturer for the appropriate cable losses.

The Cable Editor is specifically designed to provide contractors, service providers, and network operators with a list of cable types that are tailored to their use.

To open the Cable Editor, select the **Tools** menu and select **Cable Editor**.

To open an existing cable list file, select **File** and **Open**. Select the desired cable list and press **Enter**.

Creating a Custom Cable List

To create a custom cable list:

- Step 1.** Select the File menu and select New.
- Step 2.** Type in or cut and paste the cable types and specifications for the desired cables.

Uploading a Cable List

After custom cable list has been created in Site Master Software Tools it can upload it to the Site Master. The serial communication null modem cable must be connected from the Site Master to the PC.

In the Cable Editor, select **Tools** and **Upload Cable List**. The software will confirm the upload with a message "Upload Complete" when the operation is finished.

Querying the Site Master Cable List

Query Cable List allows the user to check and review the contents of the custom cable list in the Site Master.

In the Cable Editor, select **Tools** and **Query Cable List**. The software will download the cable list from the Site Master to the PC.

Entering Antenna Factors

The antenna factor is a parameter of an antenna that is used in the calculation of field strength during radiated emissions measurement. It relates the voltage output of the measurement antenna to the value of the incident field producing that voltage. The units are volts output per volt/meter incident field or reciprocal meters. Antennas used for radiated emissions testing are individually calibrated (the antenna factor is directly measured) at all appropriate distances. The calibrations produce values that are defined as the "equivalent free space antenna factor." The calibration procedure corrects for the presence of the reflection of the antenna in the ground plane, giving the value that would be measured if the antenna were in "free space."

- Step 1.** Once the Site Master Software Tools has been opened, select Antenna Editor from the Tools menu on the tool bar. A pop-up box will appear on the screen of the PC.
- Step 2.** Click on "Edit Antenna" to enter an antenna name, description, frequencies, and antenna factors. Enter the frequencies in ascending order, starting with lowest frequency first. A maximum of 60 antenna factors may be entered. Use the arrow keys on the keyboard to move between entries.

NOTES: Only one input of frequency and antenna factor is allowed per row. Multiple antenna factors for a single antenna must be entered individually. For example, an antenna having an antenna factor of 5 from 2.0 to 2.25 GHz and an antenna factor of 4 from 2.25 to 2.5 GHz should be entered as follows:

Frequency (MHz)	Antenna Factor
2000	5
2251	4
2500	4

If necessary, an antenna factor of zero (0) may be entered.

- Step 3.** Select Save from the File menu to save the antenna factors to the hard disk.

Uploading Antenna Factors

To upload antenna information from Software Tools to the Site Master:

- Step 1.** Connect the RS232 cable between the PC and the Site Master.
- Step 2.** Click on the **Upload** button on the tool bar (or select **Upload** from the **Tools** menu). It is important to note that the Site Master must sweep very quickly during the data transfer, at least every 5 seconds, or the Software Tools program may “time-out.” To improve the chances of a successful upload, increase the RBW and VBW settings to the maximum.
- Step 3.** To determine if the antenna information has been successfully uploaded to the Site Master, press the measure function key (#4 key) and activate the field strength measurement by pressing the ON/OFF soft key.

Creating a Database

A single trace or a block of traces can be transferred from the Site Master to the PC. A separate database can be created for each cellular site. The site name can be used as the database name.

- Step 1.** Select the **File** menu and select the **Database**.
- Step 2.** Open an existing database or create a new database with a descriptive filename that represents the site name.

Once the database has been created, files can be saved and site information can be added, such as Plot Description, Date/Time, Operator, record/trace number and session description (Transmitter type etc.)

Individual plots will be labeled with the Database Site Name. Each record has its own plot description and measurement type (for example, Return Loss-antenna, Return Loss-cable, and DTF-Return Loss).

Printing Formats

One to multiple plots per page can be set up under the print format in Site Master Software Tools. Orientation of how the plots are printed on the page can be changed from vertical to horizontal.



Appendix A

Reference Data

Coaxial Cable Technical Data

Table A-1 provides a standard listing of common coaxial cables along with their Relative Propagation Velocity and Nominal Attenuation values in dB/m @ 1000, 2000, and 2500 MHz. (N/A indicates that the specification is not applicable to the listed cable.)

Table A-1. Coaxial Cable Technical Data (1 of 3)

Manufacturer	Cable Type	Relative Propagation Velocity (Vf)	Nominal Attenuation dB/m @ 1000 MHz	Nominal Attenuation dB/m @ 2000 MHz	Nominal Attenuation dB/m @ 2500 MHz
Andrew	FSJ1-50A	0.84	0.197	0.285	0.323
Andrew	FSJ2-50	0.83	0.134	0.196	0.224
Andrew	FSJ4-50B	0.81	0.119	0.176	0.202
Andrew	LDF4-50A	0.88	0.077	0.113	0.133
Andrew	LDF5-50A	0.89	0.043	0.064	0.077
Andrew	LDF6-50	0.89	0.032	0.048	0.056
Andrew	LDF7-50A	0.88	0.027	0.041	0.047
Andrew	LDF12-50	0.88	0.022	0.035	N/A
Andrew	HJ4-50	0.914	0.087	0.126	0.15
Andrew	HJ4.5-50	0.92	0.054	0.079	0.084
Andrew	HJ5-50	0.916	0.042	0.063	0.07
Andrew	HJ7-50A	0.921	0.023	0.034	0.04
Andrew	HJ12-50	0.931	0.019	0.029	N/A
Belden	RG8, 8A	0.659	0.262	N/A	N/A
Belden	RG9, 9A	0.659	0.289	N/A	N/A
Belden	RG17, 17A	0.659	0.18	N/A	N/A
Belden	RG55, 55A, 55B	0.659	0.541	N/A	N/A
Belden	RG58, 58B	0.659	0.558	N/A	N/A
Belden	RG58A, 58C	0.659	0.787	N/A	N/A
Belden	RG142	0.659	0.443	N/A	N/A
Belden	RG174	0.659	0.984	N/A	N/A
Belden	RG178B	0.659	1.509	N/A	N/A
Belden	RG188	0.659	1.017	N/A	N/A
Belden	RG213	0.659	0.292	N/A	N/A
Belden	RG214	0.659	0.292	N/A	N/A
Belden	RG223	0.659	0.535	N/A	N/A

Appendix A Reference Data

Table A-1. Coaxial Cable Technical Data (2 of 3)

Manufacturer	Cable Type	Relative Propagation Velocity (Vf)	Nominal Attenuation dB/m @ 1000 MHz	Nominal Attenuation dB/m @ 2000 MHz	Nominal Attenuation dB/m @ 2500 MHz
Cablewave	HCC12-50J	0.915	0.087	0.126	0.137
Cablewave	HCC78-50J	0.915	0.041	0.061	0.066
Cablewave	HCC158-50J	0.95	0.022	0.031	0.033
Cablewave	HCC300-50J	0.96	0.015	N/A	N/A
Cablewave	HCC312-50J	0.96	0.013	N/A	N/A
Cablewave	HF 4-1/8" Cu2Y	0.97	0.01	N/A	N/A
Cablewave	HF 5" Cu2Y	0.96	0.007	N/A	N/A
Cablewave	HF 6-1/8" Cu2Y	0.97	0.006	N/A	N/A
Cablewave	FLC 38-50J	0.88	0.115	0.169	0.19
Cablewave	FLC 12-50J	0.88	0.072	0.11	0.134
Cablewave	FLC 78-50J	0.88	0.041	0.061	0.072
Cablewave	FLC 114-50J	0.88	0.033	0.05	0.059
Cablewave	FLC158-50J	0.88	0.025	0.038	0.042
Comscope	CR50 540 PE	0.88	0.069	0.103	0.116
Comscope	CR50 1070PE	0.88	0.037	0.055	0.064
Comscope	CR50 1873PE	0.88	0.022	0.0344	0.04
NK Cables	RF 1/2" -50	0.88	0.0757	0.112	0.127
NK Cables	RF 1/2" -50 GHF	0.88	0.0757	0.112	0.127
NK Cables	RF 1/2" -50 BHF	0.88	0.0757	0.112	0.127
NK Cables	RF 5/8"-50	0.88	0.0518	0.0768	0.087
NK Cables	RF 5/8"-50 GHF"	0.88	0.0518	0.0768	0.087
NK Cables	RF 5/8"-50 BHF"	0.88	0.0518	0.0768	0.087
NK Cables	RF 7/8"-50	0.88	0.0413	0.062	0.07
NK Cables	RF 7/8"-50 GHF"	0.88	0.0413	0.062	0.07
NK Cables	RF 7/8"-50 BHF"	0.88	0.0413	0.062	0.07
NK Cables	RF 1 5/8" -50	0.88	0.0248	0.038	0.044
NK Cables	RF 1 5/8" -50 GHF"	0.88	0.0248	0.038	0.044
NK Cables	RF 1 5/8" -50 BHF"	0.88	0.0248	0.038	0.044
NK Cables	RF 2 1/4" -50	0.88	0.021	0.034	N/A
NK Cables	RF 2 1/4" -50 GHF	0.88	0.021	0.034	N/A

Table A-1. Coaxial Cable Technical Data (3 of 3)

Manufacturer	Cable Type	Relative Propagation Velocity (Vf)	Nominal Attenuation dB/m @ 1000 MHz	Nominal Attenuation dB/m @ 2000 MHz	Nominal Attenuation dB/m @ 2500 MHz
NK Cables	RF 2 ¼" -50 BHF	0.88	0.021	0.034	N/A
NK Cables	RFF 3/8" -50	0.81	0.147	0.218	0.25
NK Cables	RFF 3/8" -50 GHF	0.81	0.147	0.218	0.25
NK Cables	RFF 3/8" -50 BHF	0.81	0.147	0.218	0.25
NK Cables	RFF ½" -50	0.82	0.112	0.167	0.19
NK Cables	RFF ½" -50 GHF	0.82	0.112	0.167	0.19
NK Cables	RFF ½" -50 BHF	0.82	0.112	0.167	0.19
NK Cables	RFF 7/8" -50	0.84	0.052	0.078	0.089
NK Cables	RFF 7/8" -50 GHF	0.84	0.052	0.078	0.089
NK Cables	RFF 7/8" -50 BHF	0.84	0.052	0.078	0.089
Times	LMR100	0.8	0.792	1.15	1.31
Times	LMR200	0.83	0.344	0.49	0.554
Times	LMR240	0.84	0.262	0.377	0.424
Times	LMR400	0.85	0.135	0.196	0.222
Times	LMR500	0.86	0.109	0.159	0.18
Times	LMR600	0.87	0.087	0.128	0.145
Times	LMR900	0.87	0.056	0.086	0.098
Times	LMR1200	0.88	0.044	0.065	0.074
Times	LMR1700	0.89	0.033	0.049	0.056
-	310801	0.821	0.115	N/A	N/A
-	311201	0.82	0.18	N/A	N/A
-	311501	0.8	0.23	N/A	N/A
-	311601	0.8	0.262	N/A	N/A
-	311901	0.8	0.377	N/A	N/A
-	352001	0.8	0.377	N/A	N/A



Appendix B

Windowing

Introduction

The Distance sub-menu (page 2-10) provides for setting the cable loss and relative propagation velocity of the coaxial cable. The WINDOW key opens a menu of FFT windowing types for the DTF calculation.

The theoretical requirement for inverse FFT is for the data to extend from zero frequency to infinity. Side lobes appear around a discontinuity due to the fact that the spectrum is cut off at a finite frequency. Windowing reduces the side lobes by smoothing out the sharp transitions at the beginning and at the end of the frequency sweep. As the side lobes are reduced the main lobe widens thereby reducing the resolution.

In situations where there may be a small discontinuity close to a large one, side lobe reduction windowing should be used. When distance resolution is critical windowing can be reduced.

Examples

The types of windowing in order of increasing side lobe reduction are: rectangular, nominal side lobe, low side lobe, and minimum side lobe. Figures B-1 thru B-4 show examples of the types of windowing.

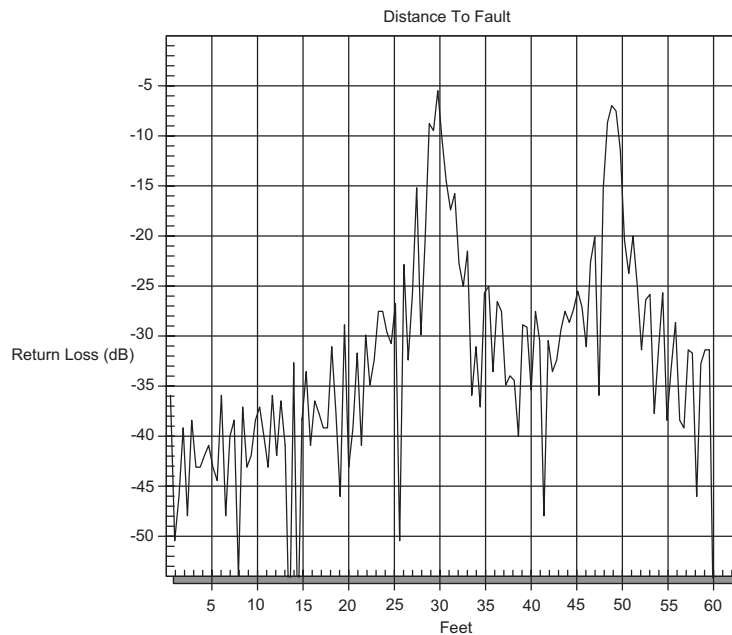

Figure B-1. Rectangular Windowing Example

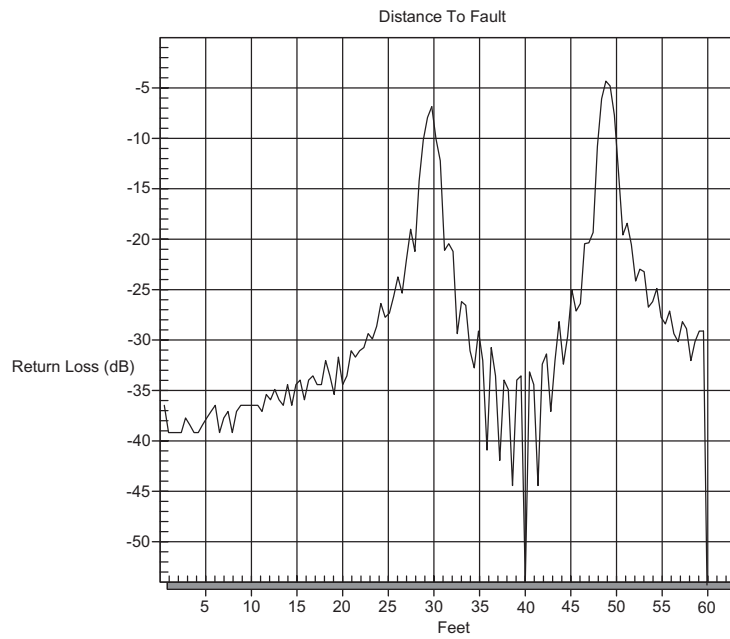

Figure B-2. Nominal Side Lobe Windowing Example

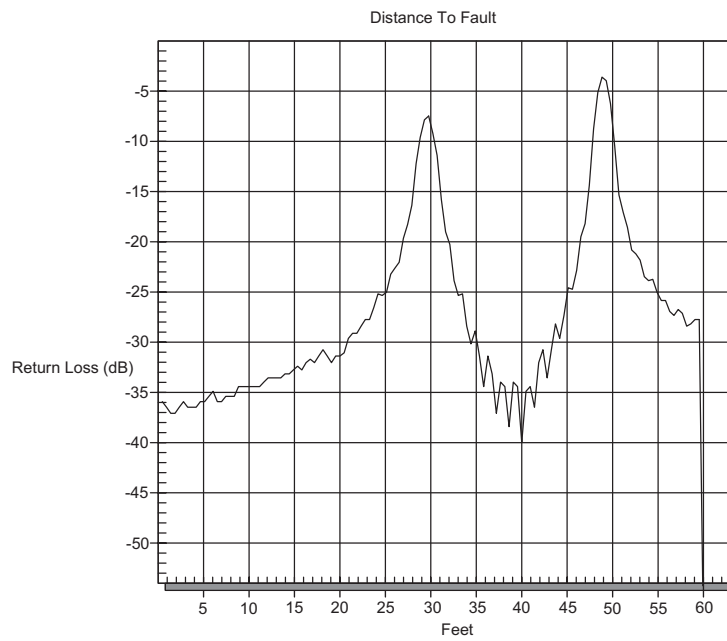

Figure B-3. Low Side Lobe Windowing Example

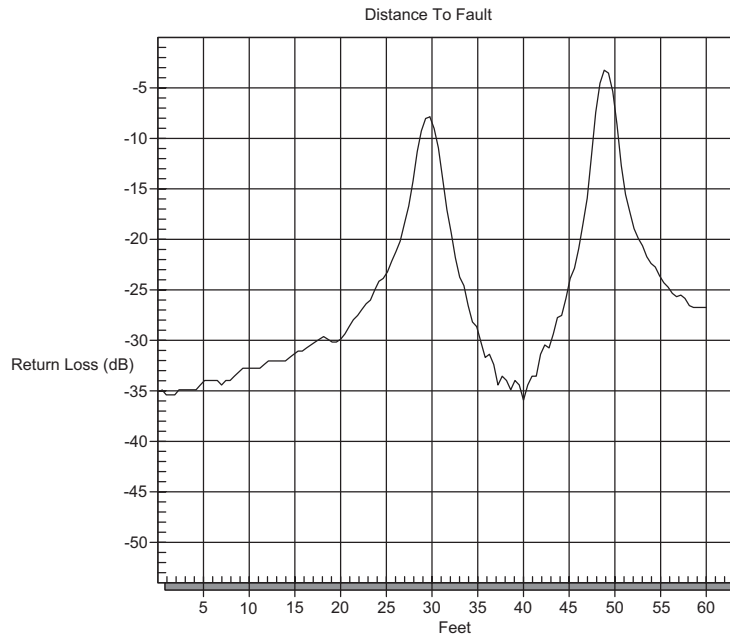

Figure B-4. Minimum Side Lobe Windowing Example





Anritsu

Free Manuals Download Website

<http://myh66.com>

<http://usermanuals.us>

<http://www.somanuals.com>

<http://www.4manuals.cc>

<http://www.manual-lib.com>

<http://www.404manual.com>

<http://www.luxmanual.com>

<http://aubethermostatmanual.com>

Golf course search by state

<http://golfingnear.com>

Email search by domain

<http://emailbydomain.com>

Auto manuals search

<http://auto.somanuals.com>

TV manuals search

<http://tv.somanuals.com>