

AUDIOVOX

Universal power windows MOUNTING INSTRUCTIONS

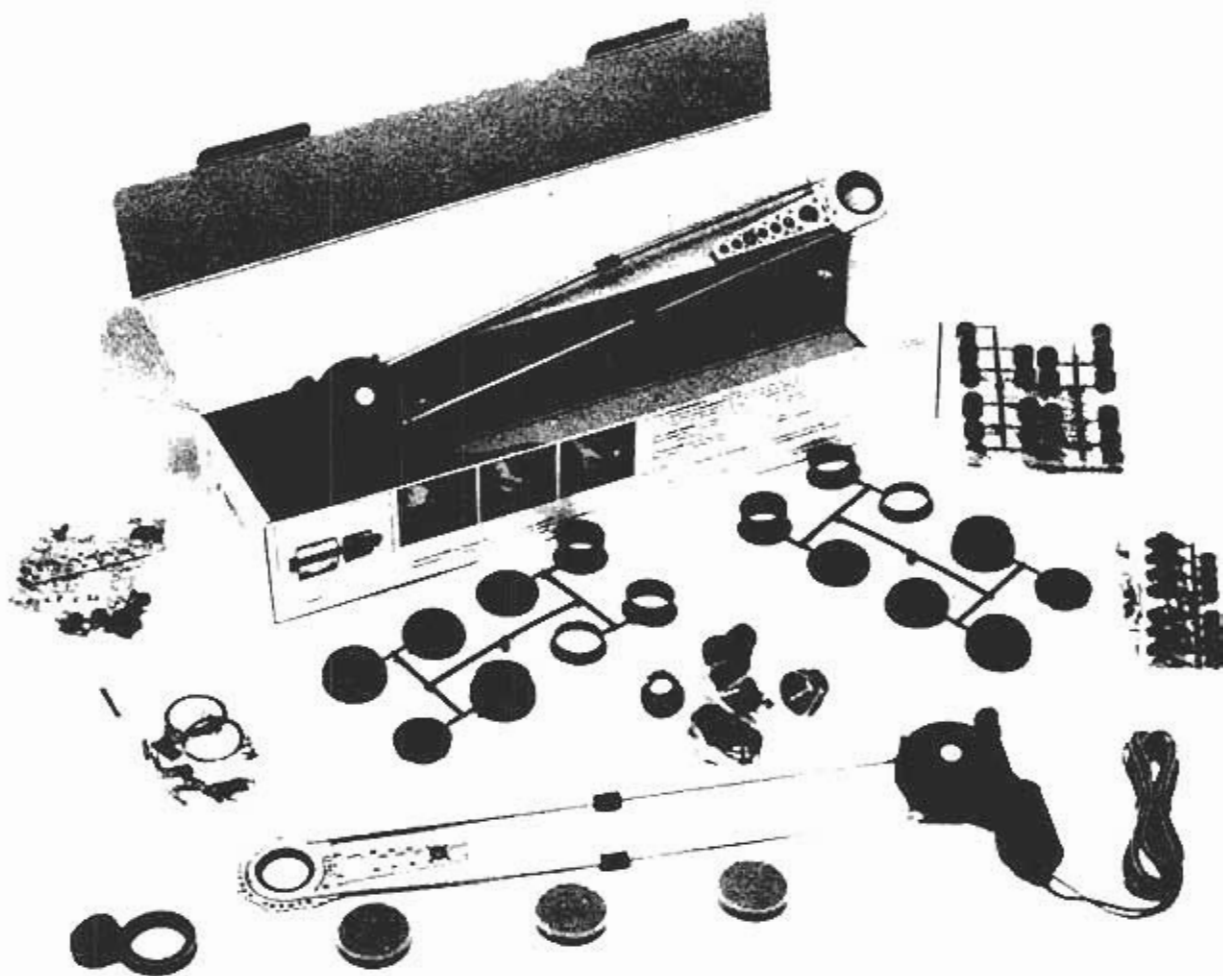

- DETAILED INSTRUCTIONS FOR MOUNTING POWER WINDOWS ON THE **U.S.** CARS

1

REMOVE HANDLE FROM WINDOW REGULATOR/PIVOT

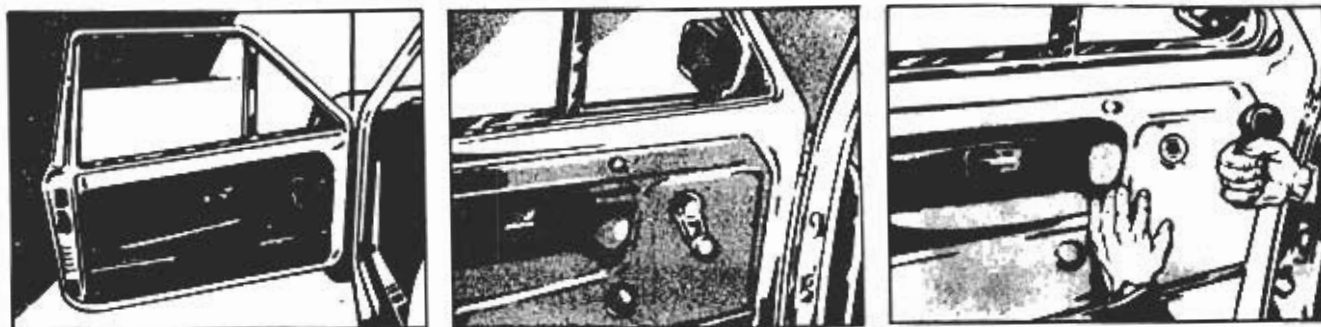
**2**

APPLY CENTERING ADHESIVE TO THE PANEL



Place adhesive over pivot making sure that it adheres properly to door casing

3

PANEL DEMOUNTING

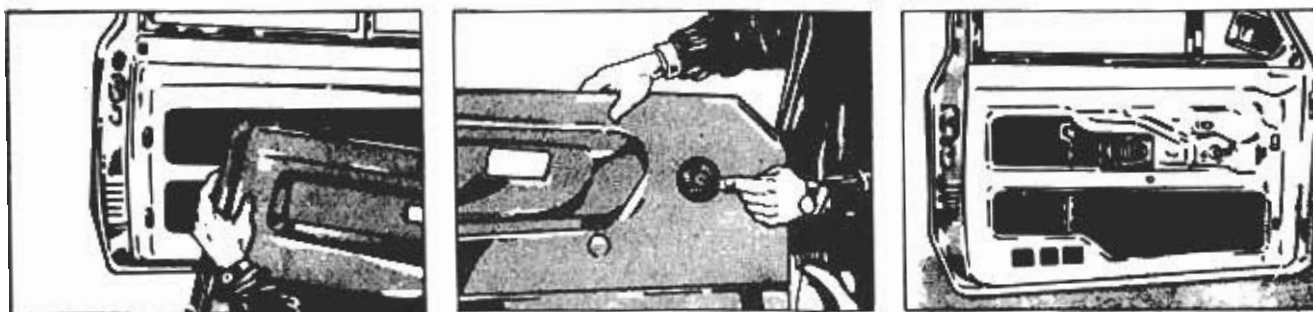

Remove door panel.
Make sure the centering adhesive is firmly applied to the panel

4

MANUALLY CHECK THE MOVEMENT OF THE WINDOW

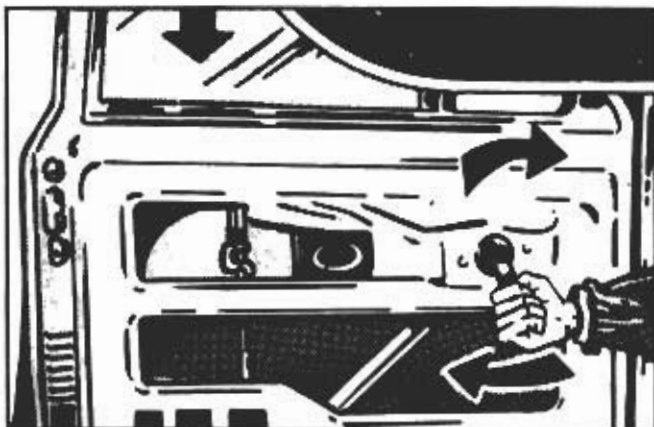

Adjust the registers or guides if the window does not operate freely

5

OPTIONAL OPERATION:

A • IN ORDER TO USE THE SMALLEST CAP ON SOME VEHICLES, IT MAY BE NECESSARY TO MOVE BACK THE WINDOW REGULATOR ASSEMBLY.

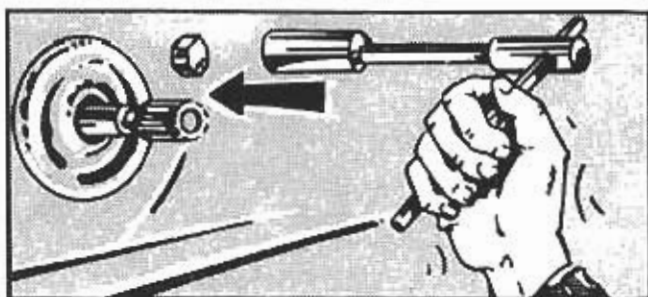

B • AFTER REMOVING ORIGINAL BOLTS FROM THEIR SEATS, REFER TO THE TABLE BELOW TO CHOOSE SUITABLE SPACERS AND BOLTS (SUPPLIED IN KIT No. 2).

KIT No. 2



KIT No. 2

Trapezoidal spacers h. 5/16"	Bolts h. 3/8"
Trapezoidal spacers h. 3/16"	Bolts h. 9/16"
Trapezoidal spacers h. 3/8"	Bolts h. 3/4"

C - INSERT SPACERS BETWEEN MANUAL MECHANISM AND DOOR-PANEL

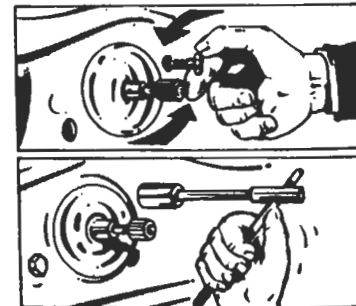
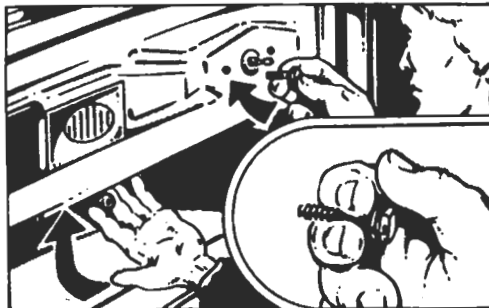

Check that the bolts of the window assembly are tight

6

FIT ADAPTOR ON REGULATOR PIVOT

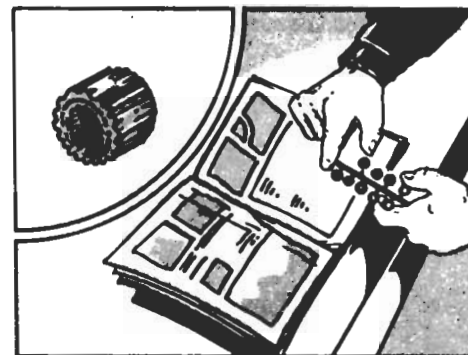
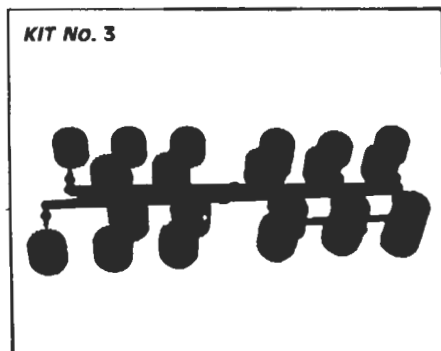

From Kit No. 3, choose the correct adaptor for the model of vehicle. See adaptor Table below.

Adaptor table (Kit No. 3)

N. 1 ALFA ROMEO - AUTOBIANCHI - BEDFORD - DAF
DATSUN - FIAT - LANCIA - MERCEDES - NISSAN
OPEL - PORSCHE - SUBARU

N. 2 ARO - CITROËN - PEUGEOT - RENAULT - SEAT
TALBOT

N. 3 AUDI - BMW - FIAT - FORD (EUROPE)
PORSCHE - VOLKSWAGEN - VOLVO

N. 4 AUSTIN ROVER

N. 5 VAUXALL - JAGUAR - BEDFORD - ROVER

N. 6 FORD (UK)

N. 7 OPEL

N. 8 DAIHATSU - MITSUBISHI - TOYOTA - SUZUKI
CHEVROLET - G.M.

N. 9 HONDA

N. 10 MAZDA

N. 11 ISUZU

N. 12 FORD (U.S.A.)

N. 13 DODGE - CHRYSLER

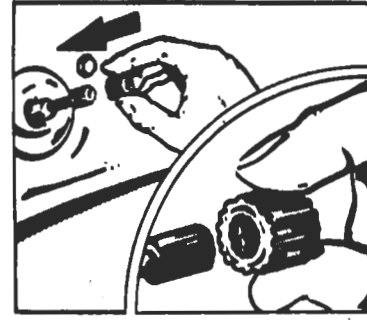
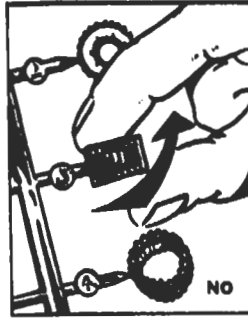
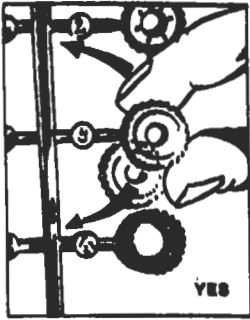

Take caution in removing adaptor from Kit. Do not twist-off.

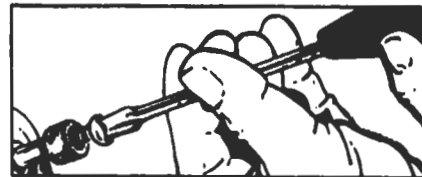
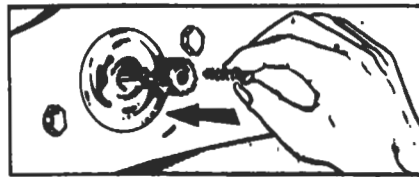

If the handle is fixed with a screw, use it to fix the adaptor

7

INSERT GEAR SLEEVE INTO THE TRANSMISSION

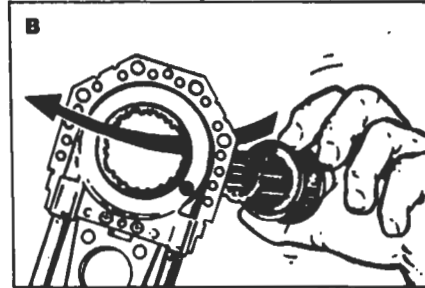
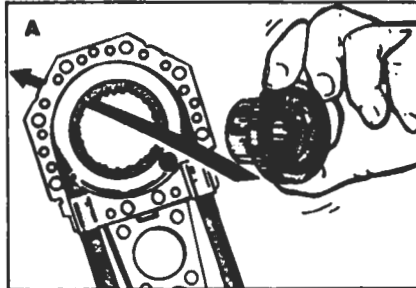
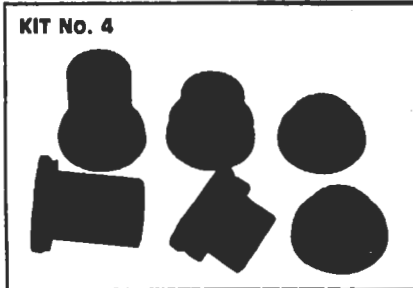

Geared sleeve to be inserted towards inside of vehicle

- A) Insertion from the red marked side.
- B) Insertion from the opposite side of the red mark.

Gear Conversion



- A) Wrong: too long.
- B) Wrong: too short.
- C) Right: length of geared sleeve and pivot are the same.

If a standard is not available for your car, gear H = 37 should be used after cutting it to match regulator pivot.

8

SECURE GEAR TO THE TRANSMISSION WITH CIRCLIP

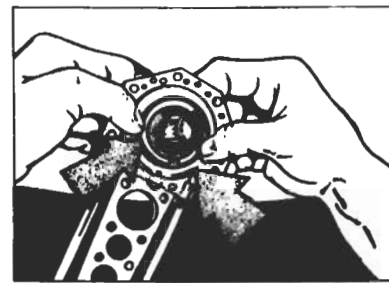
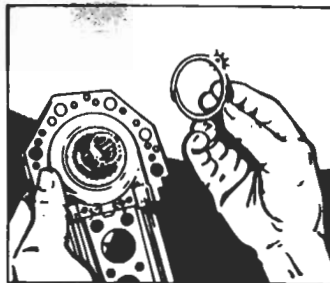
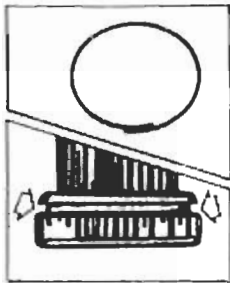
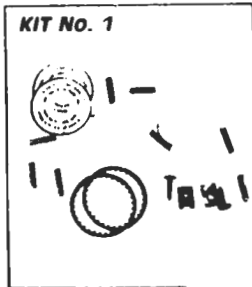

(Circlip included in KIT No

9

INSTALLATION OF THE ELECTRIC POWER WINDOW MECHANISM INTO THE DOOR

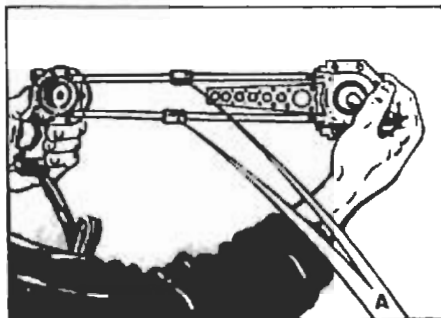
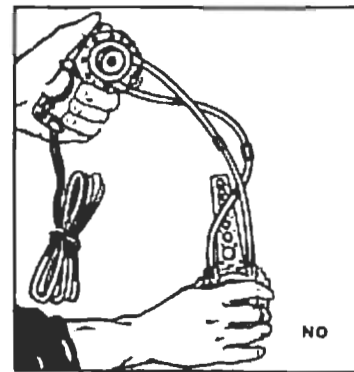
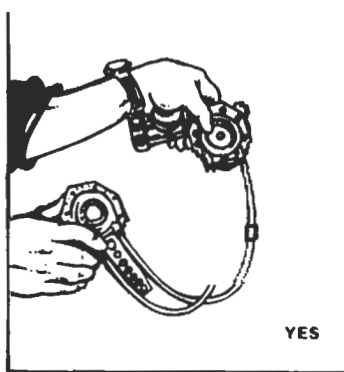
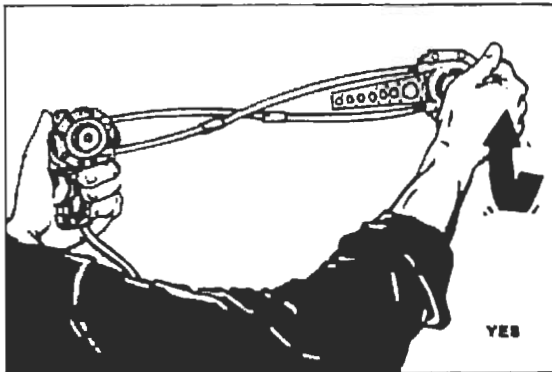

Fixing or shifting of transmission bracket.

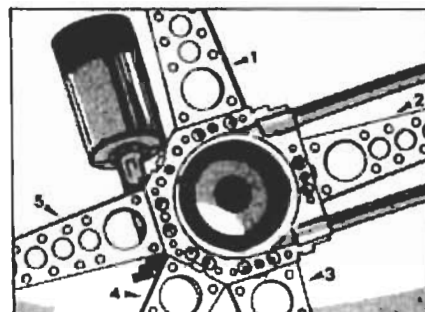
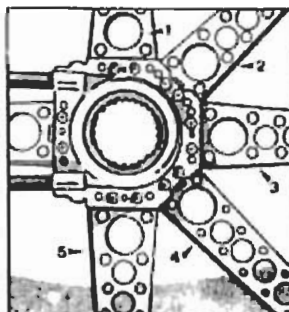
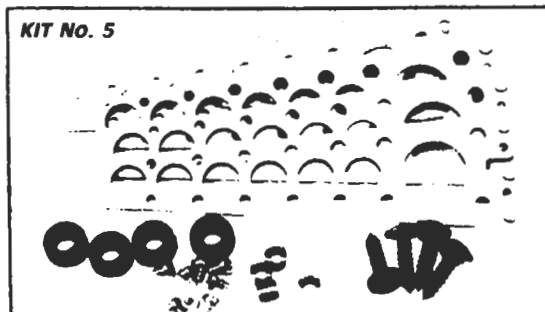

It is possible to mount one or more brackets in pos. 1 2, 3, 4, 5, as shown above 7

Motor may be rotated on transmission in order to facilitate a secure mount

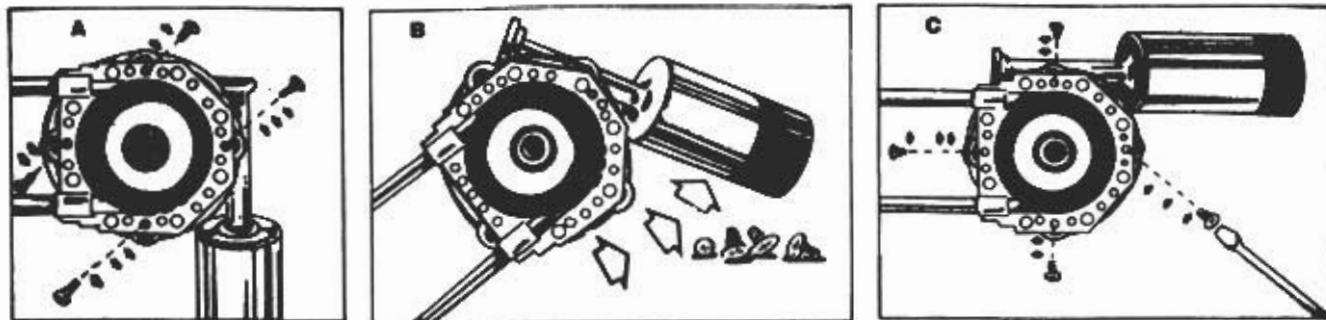

- A) Remove the screws.
- B) Rotate the geared motor to the required position.
- C) Retighten the screws in their seats.

10

FASTENING OF GEARED MOTOR

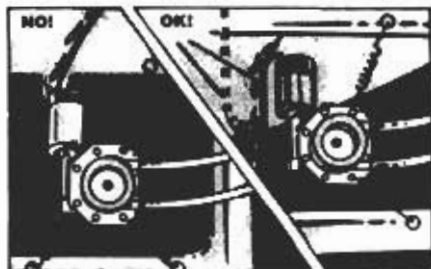

Drill door panel to hook-up springs.

IMPORTANT:

The power cable for the motor must always be positioned downwards

Fastening of geared motor with brackets

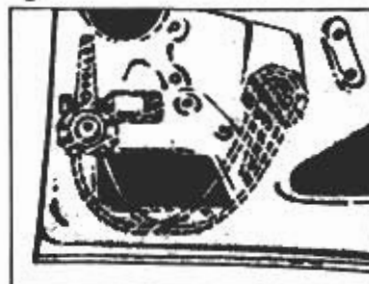
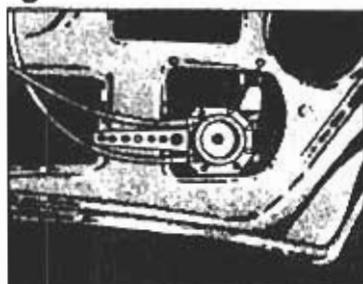
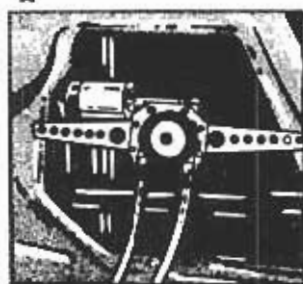

- A) Fastening with two brackets.
- B) Fastening with brackets and springs.
- C) Fasten geared motor behind door panel with one bracket.

Fastening of geared motor with springs

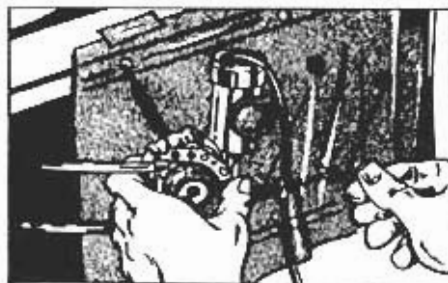
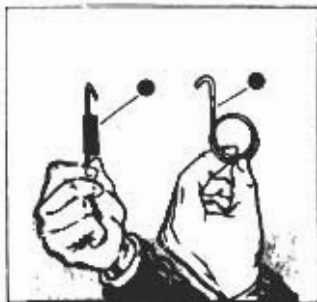
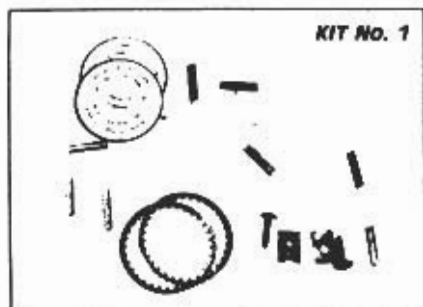

Take springs and wire clip out of KIT No. 1

- 1) Spring.
- 2) Wire clip.

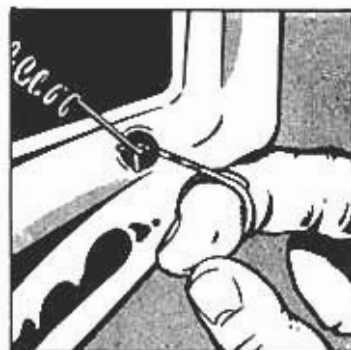
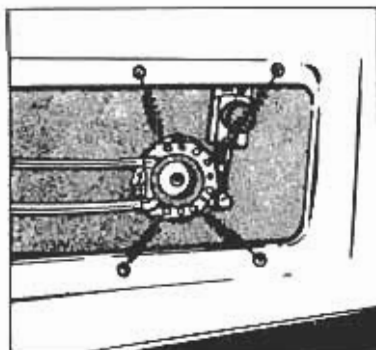

Hook up springs and lock hooks

11

APPLY PADDING TO THE GEARED MOTOR

IN CASE THE MOTOR, OR PARTS OF IT, ARE IN DIRECT CONTACT WITH ANY METAL PARTS, THE SUPPLIED PADDING SHOULD BE USED AS SHOWN BELOW.

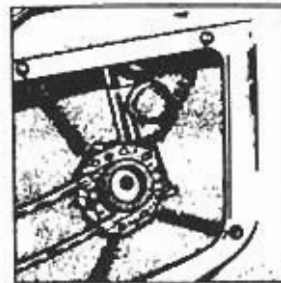
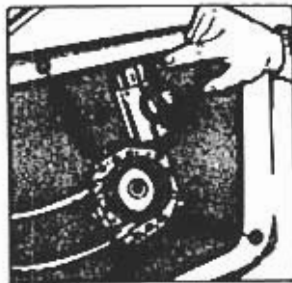
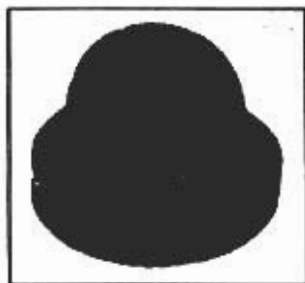

POSITION AND FIX BRACKET

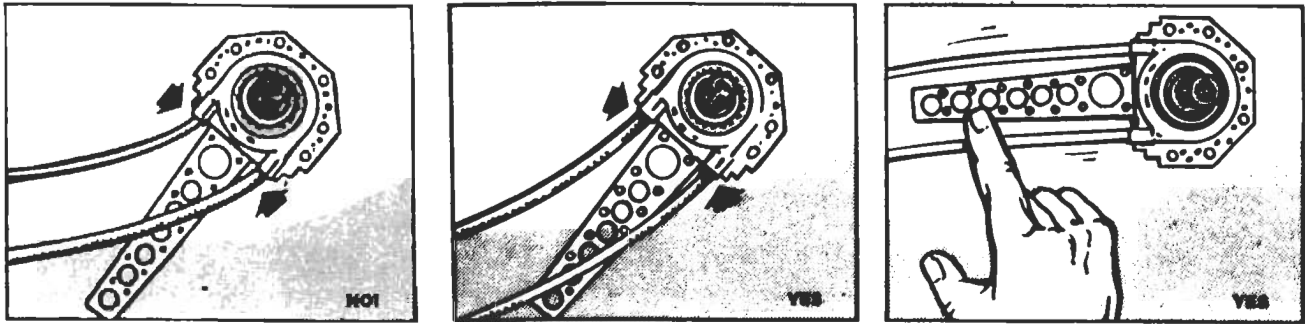

Position the bracket without forcing the transmission



Fasten bracket through one of the holes (Use the outer ones, where possible).

- 1) Internal metal bushing
- 2) External rubber bushing

Drill 7/64" holes to fasten bracket.

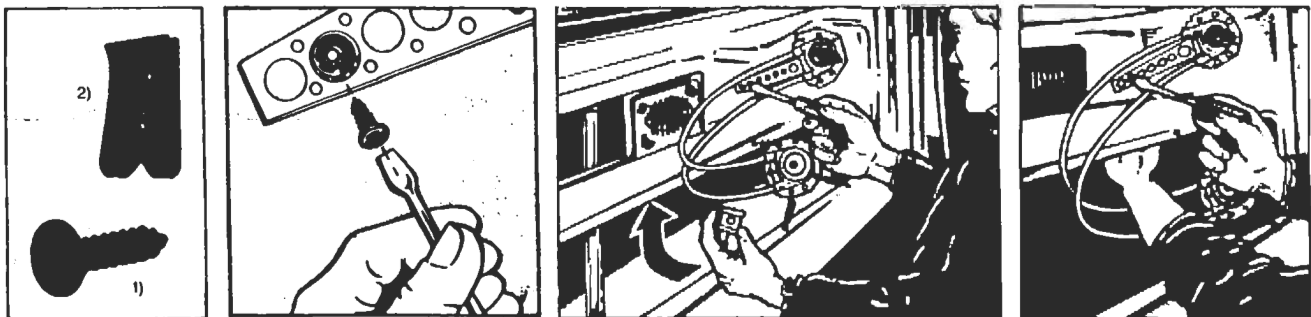

- 1) Screw
- 2) Speed nut.

LOCK ADAPTOR AND GEAR SLEEVE

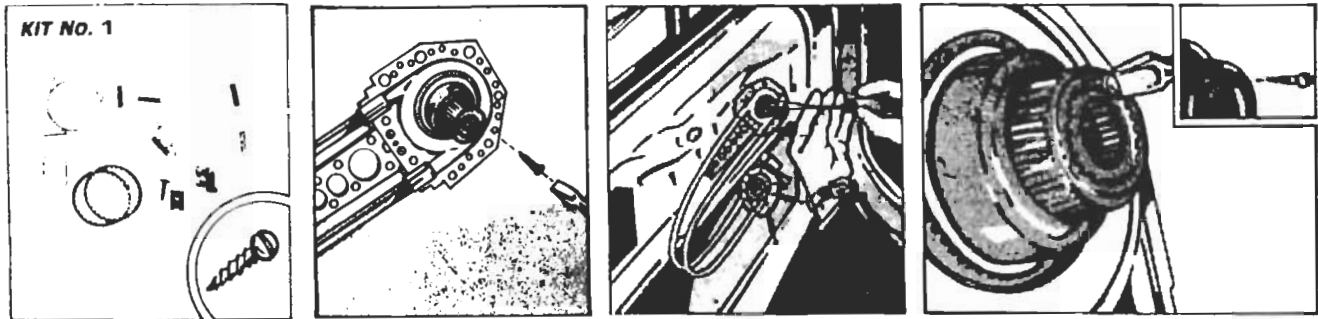

Insert the screw in the space between the adaptor and the gear sleeve

CUT DOOR PANEL WITH SPECIAL CUTTER

DOOR PANEL CUTTER TOOL SUPPLIED UPON REQUEST

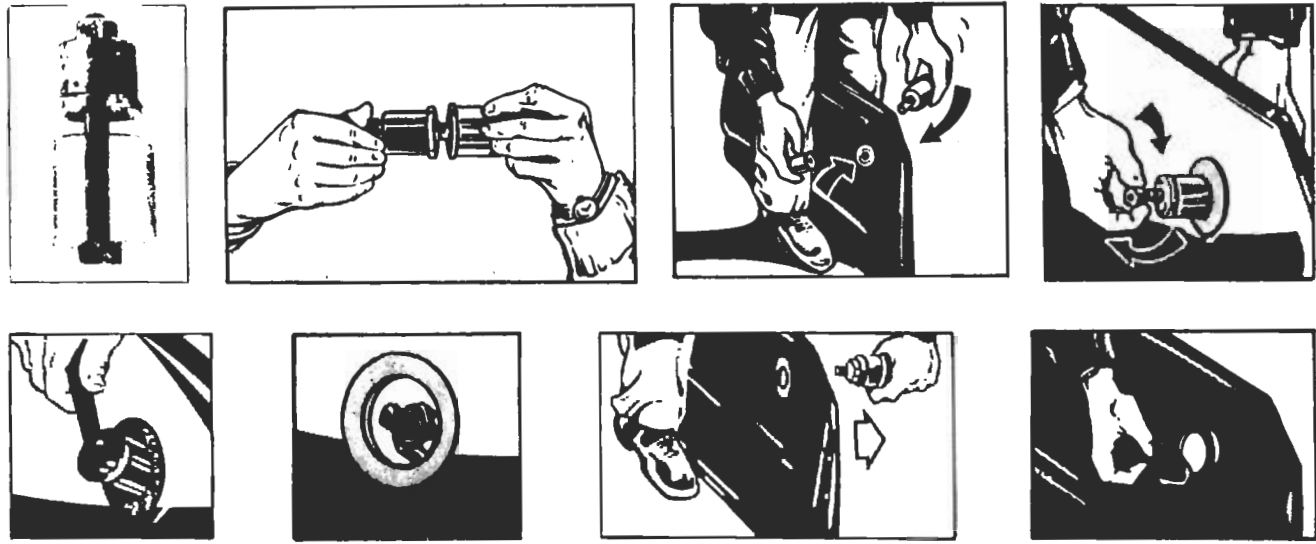

Center the cutter with the adhesive Tighten with a wrench until the cutter comes free
Remove any remaining adhesive.

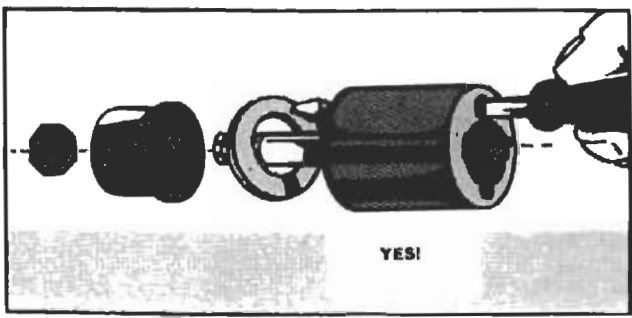
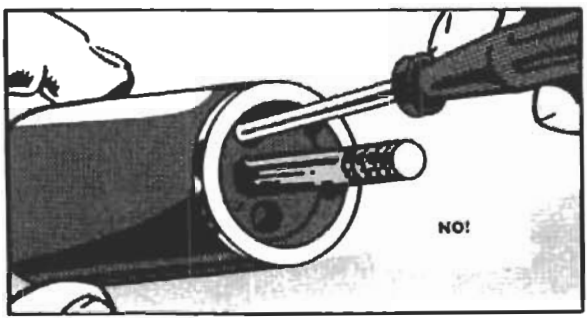

To clean out the cutter, do as shown above

FIX GROMMET WITH RETAINER RING

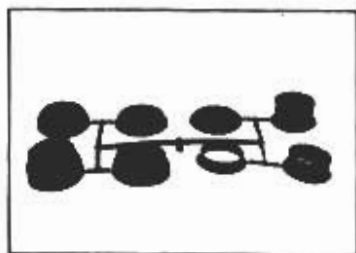

- No. 1 Small.
No. 2 Medium
No. 3 Large.

The grommet cap locks to panel by means of a retainer ring

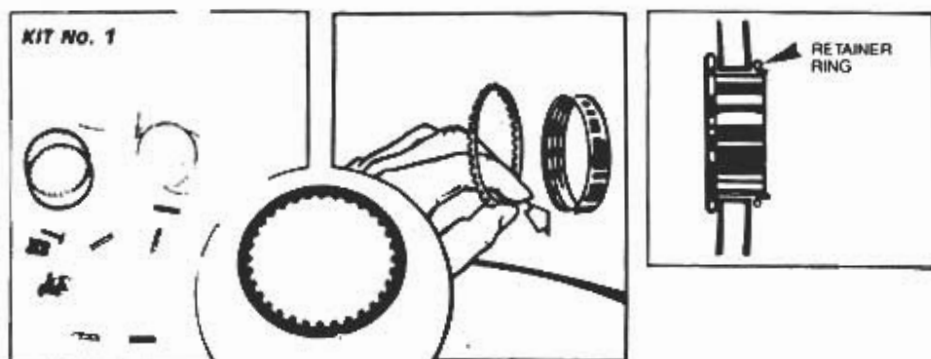

The grommet has to come through the door casing at least $5/32$ in order to be locked with the retainer ring.

To choose the proper grommet cap, follow this procedure:

- Insert grommet cap no. 1 (SMALL) into the panel, if it does not come through, try no. 2 (MEDIUM) and then, if necessary, no. 3 (LARGE).

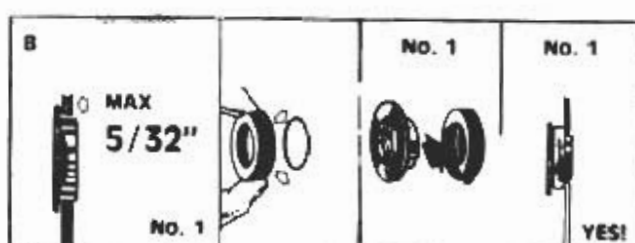
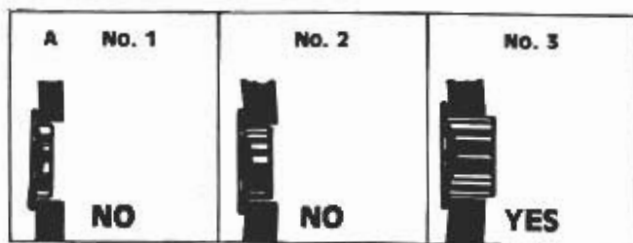

- A) No. 1 SMALL (wrong: too short).
No. 2 MEDIUM (wrong: too short)
No. 3 LARGE (yes).

- B) If the door casing is less than $5/32$ " thick a perfect fit between cap and grommet can be obtained by inserting a sponge from the rear of the door casing.

UNIVERSAL ELECTRIC WINDOWS WITHOUT CLUTCH

ART. 33000013

17

FIT CAP ON DOOR PANEL



Fit the Cap on the grommet and fit the panel on the door.

NOTE!

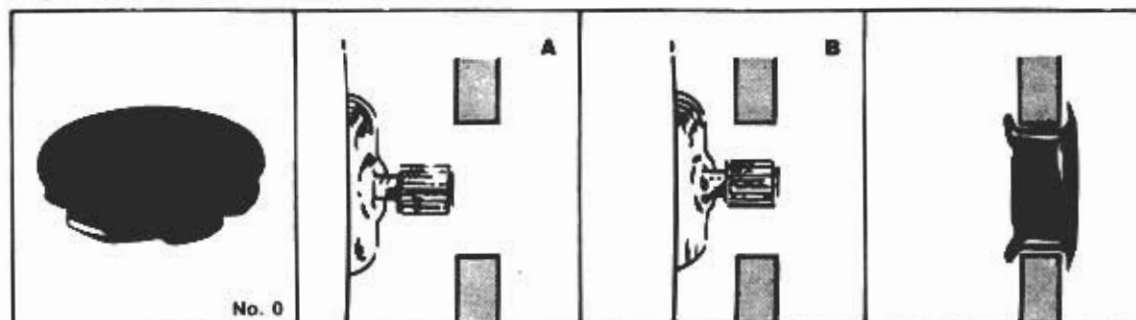

When the regulator pivot does not come out from the panel (photo **A** and **B**) you can use cap No. 0 for a better appearance.

INSTALLATION EXAMPLE FOR ELECTRIC POWER WINDOWS IN SOME CARS IN THE U.S.

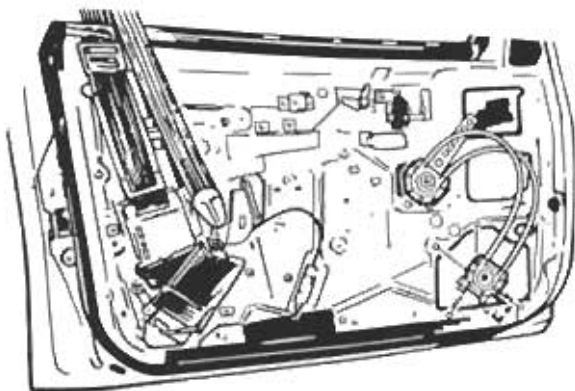

BUICK CENTURY (4 Doors) front left

- insert gear H 15 (insert from red marked side)
- adaptor No. 8
- turn transmission side of geared motor towards inside of car
- affix geared motor with springs
- grommet No. 1
- cap No. 1

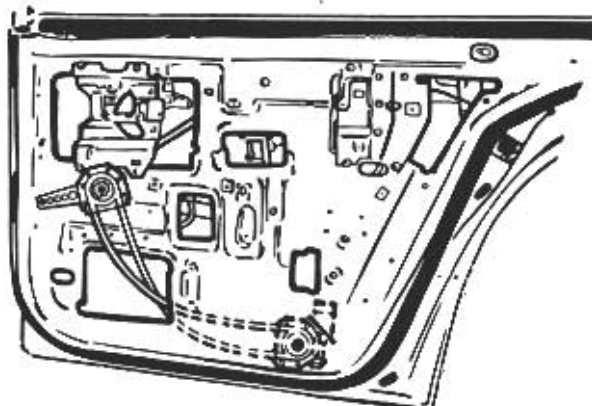

BUICK CENTURY (4 Doors) rear right

- adjust bracket on transmission shortened 1"
- insert gear H 15 (insert from red marked side)
- adaptor No. 8
- turn transmission side of geared motor towards inside of car
- affix geared motor with plastic fastener
- grommet No. 1
- cap No. 1

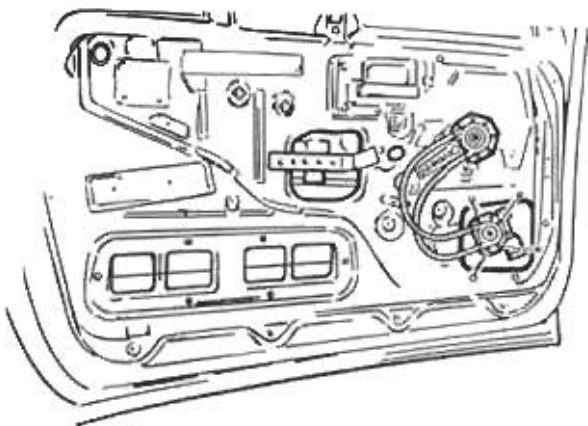

CHEVROLET FULL SIZE mod. '88 front left

- insert gear H 15 (insert from red marked side)
- adaptor No. 8
- turn transmission side of geared motor towards inside of car
- affix geared motor with springs
- grommet No. 1
- cap No. 1

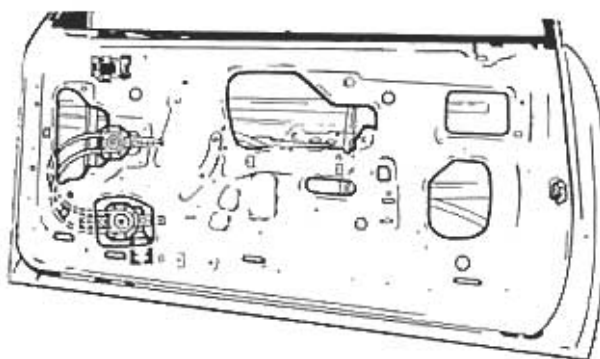

FORD MUSTANG front right

- adjust bracket on transmission
- insert gear H 15 (insert from red marked side)
- adaptor No. 12
- apply paddings to geared motor
- turn transmission side of geared motor towards inside of car
- affix geared motor with two brackets
- grommet No. 1
- cap No. 1

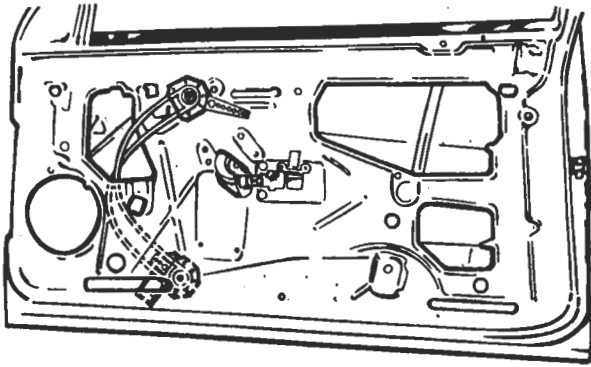

FORD TEMPO front right

- adjust bracket on transmission
- rotate geared motor 180° on transmission
- insert gear H 15 (insert from red marked side)
- adaptor No. 12
- apply paddings to geared motor
- turn transmission side of geared motor towards inside of car
- affix geared motor with bracket shortened 2.2"
- grommet No. 1
- cap No. 1

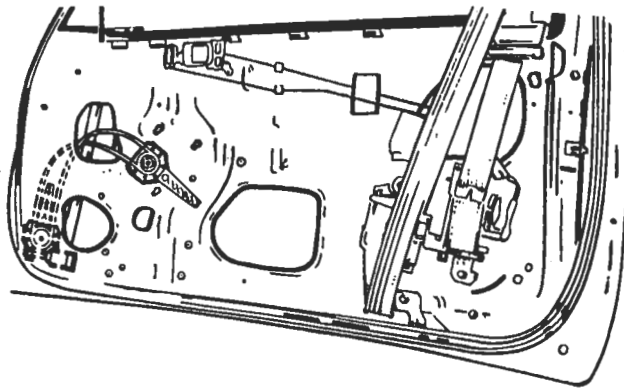

HONDA ACCORD front right

- adjust bracket on transmission
- insert gear H 15 (insert from red marked side)
- adaptor No. 9
- apply paddings to geared motor
- turn transmission side of geared motor towards inside of car
- affix geared motor with plastic fastener
- grommet No. 1
- cap No. 2
- * Bend door panel in area where cables cross. Affix cables to door panel with plastic fastener.
- * Care should be taken to not damage the geared motor with door stopper

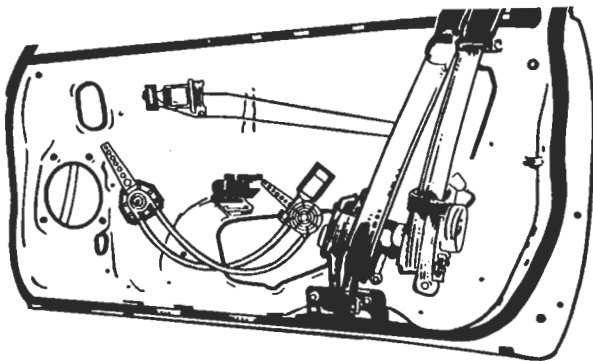

HONDA CIVIC CRX front right

- adjust bracket on transmission
- rotate geared motor 90° on transmission
- insert gear H 15 (insert from red marked side)
- adaptor No. 9
- apply paddings to grill of geared motor
- turn transmission side of geared motor towards inside of car
- affix geared motor with bracket (affix support arm screw)
- grommet No. 1
- cap No. 1

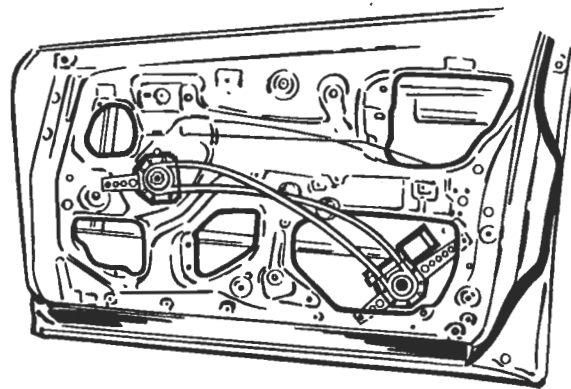

MAZDA 626 4 Doors (U.S.) mod. '89 front right

- adjust bracket on transmission shortened 1"
- rotate geared motor 90° on transmission
- insert gear H 15 (insert from red marked side)
- adaptor No. 10
- turn transmission side of geared motor towards inside of car
- affix geared motor with two brackets after having shortened one off 1"
- grommet No. 1
- cap No. 1

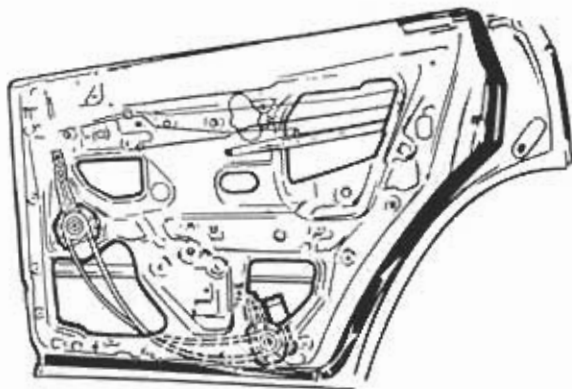

MAZDA 626 4 Doors (U.S.) mod. '89 rear right

- adjust bracket on transmission and bend appropriately
- insert gear H 15 (insert from red marked side)
- adaptor No. 10
- apply paddings to geared motor
- turn transmission side of geared motor towards inside of car
- affix geared motor with bracket shortened 1"
- grommet No. 1
- cap No. 1

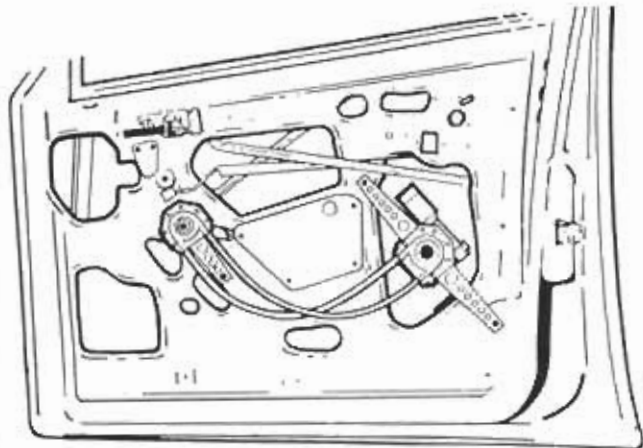

PONTIAC 6000 front right

- insert gear H 37 (insert from red marked side)
- adaptor No. 8
- turn transmission side of geared motor towards inside of car
- affix geared motor with two brackets
- grommet No. 1
- cap No. 1

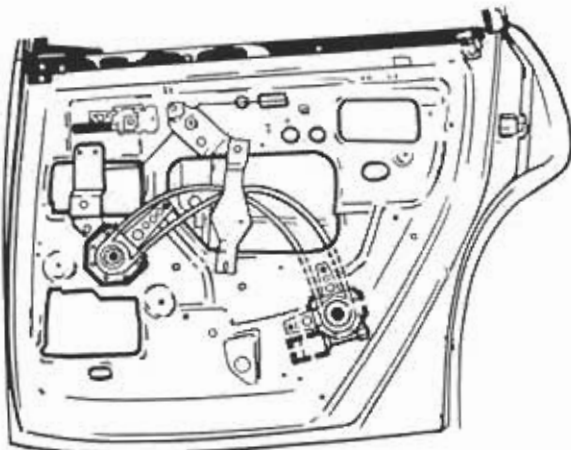

PONTIAC 6000 rear right

- shorten bracket on transmission 6"
- insert gear H 15 (insert from red marked side)
- adaptor No. 8
- apply paddings to geared motor
- turn transmission side of geared motor towards inside of car
- affix geared motor with two bracket shortened 2.2"
- grommet No. 1
- cap No. 1

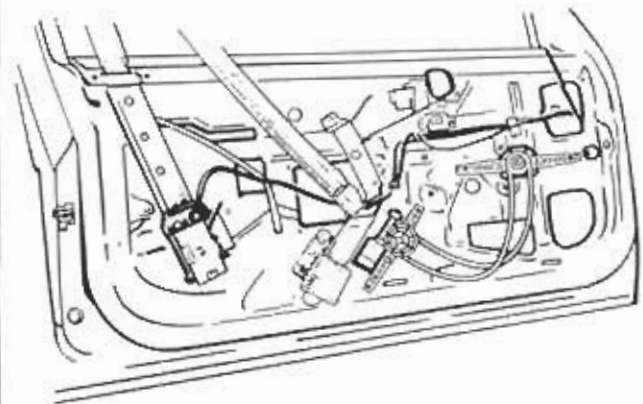

PONTIAC GRAN PRIX front left

- adjust bracket on transmission and add a new one
- insert gear H 25 (insert from red marked side)
- adaptor No. 8
- apply paddings to geared motor
- turn grill side of geared motor towards inside of car
- affix geared motor with bracket shortened 2.2"
- grommet No. 1
- cap No. 1

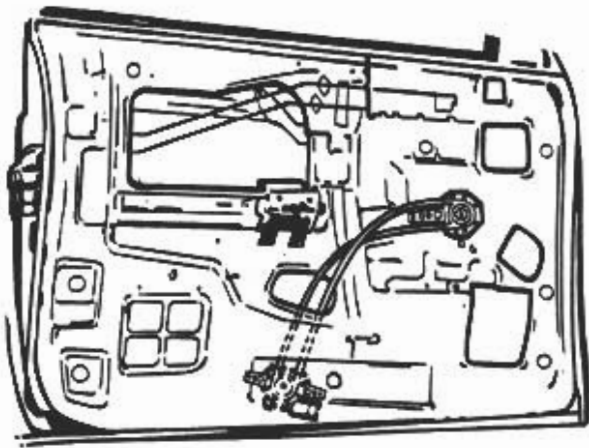

CHEVROLET/GMC S-10/15 PICKUP front left

- shorten bracket on transmission 1.6"
- gear H 15 (insert from red marked side)
- adaptor No. 8
- apply paddings to geared motor
- turn transmission side of geared motor towards inside of car
- affix geared motor with two brackets
- grommet No. 1 (may need to use with 2.9" plastic round washer)
- cap No. 1

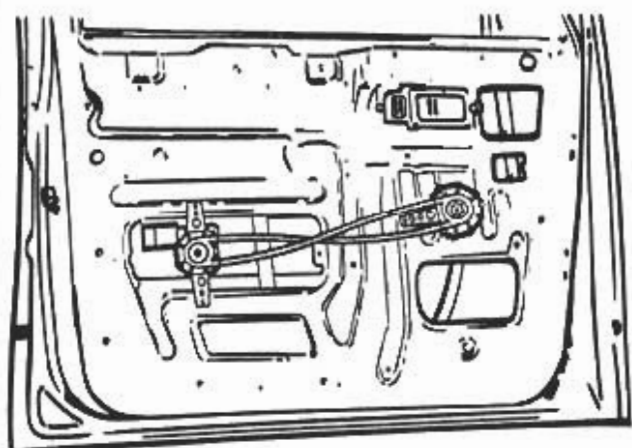

DODGE CARAVAN front left

- shorten bracket on transmission 1.6"
- rotate geared motor 90° on transmission
- insert gear H 15 (insert from red marked side)
- adaptor No. 13
- turn transmission side of geared motor towards inside of car
- affix geared motor with two brackets shortened 2.2"
- grommet No. 1
- cap No. 1

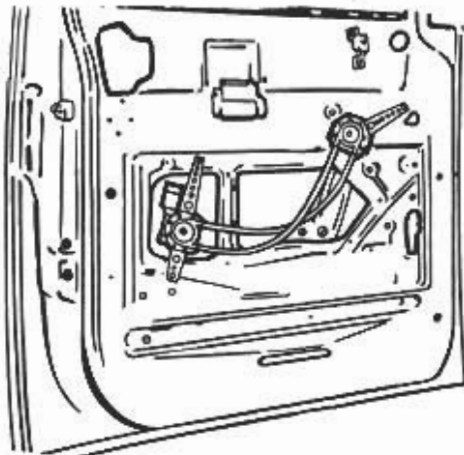

FORD AEROSTAR front left

- adjust bracket on transmission
- insert gear H 15 (insert from red marked side)
- adaptor No. 12
- turn transmission side of geared motor towards inside of car
- affix geared motor with two brackets
- grommet No. 1
- cap No. 1

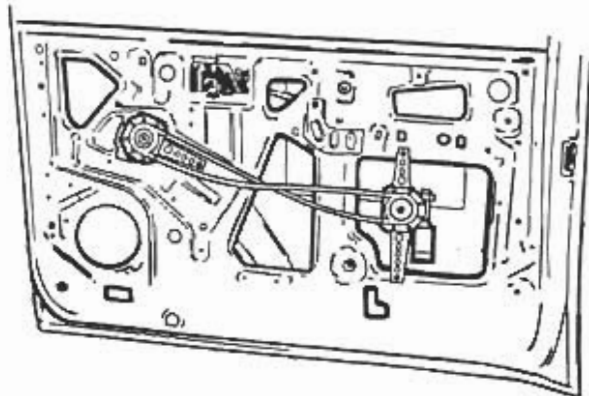

FORD RANGER mod. '89 front right

- insert gear H 15 (insert from red marked side)
- adaptor No. 12
- turn transmission side of geared motor towards
- affix geared motor with two brackets after having shortened one off 1"
- grommet No. 1
- cap No. 1

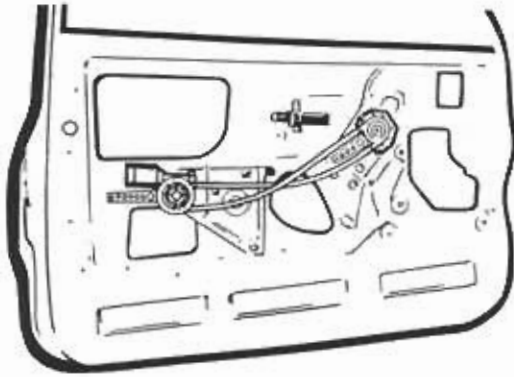

ISUZU PICKUP front left

- rotate geared motor 90° on transmission
- insert gear H 15 (insert from opposite side of red marked side)
- adaptor No. 1
- apply paddings to geared motor
- turn grill side of geared motor towards inside of car
- affix geared motor with bracket
- grommet No. 1
- cap No. 1

SWITCH CONNECTION DIAGRAMS

NOTE! Make sure that the seats where the switches are housed are not narrow in order to avoid malfunctions, jamming or are not too tight causing damage to the motor. Whenever possible, use the TEMPLATE set with the KIT.

Lighted switch with 6 contacts
Ex. Art. 17400045-48-49-50-51-52

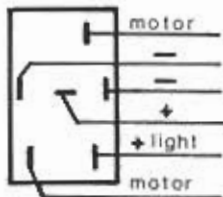

Lighted switch with 6 contacts
Switch with 6 contacts with light separated
Ex. Art. 17400047-54

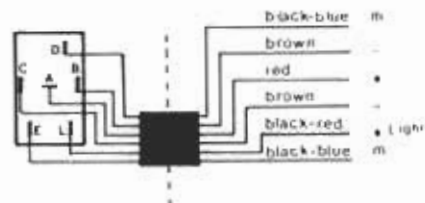

ELECTRICAL WIRING DIAGRAMS

Listed here are wiring diagrams of typical installations for the Electric window kits using the wiring kits.

NOTE! For safety reasons it is necessary that the power supply to the windows be connected to the appropriate terminal of the ignition side of the ignition relay block. It is recommended that only wiring kits be used. Whenever this is not possible, proper wiring of at least 16 AWG must be used with the suitable in-line fuse.

assumes no liability in case of non-compliance with the above mentioned note.



ELECTRICAL CIRCUIT: 2 SWITCH WITH 6 CONTACTS AND SEPARATE LIGHT

* Use original wiring, Art. 33020009 complete with 25 Amp. fuse.

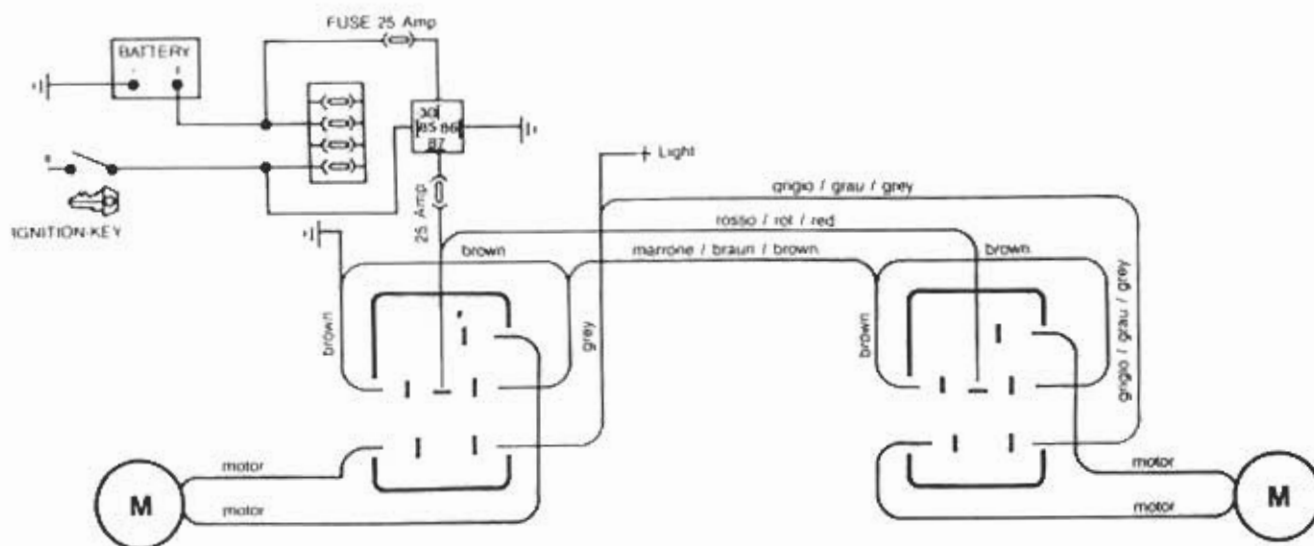



ELECTRICAL CIRCUIT: 3 SWITCH WITH 6 CONTACTS AND SEPARATE LIGHT

* Use original wiring, Art. 33020010 complete with 25 Amp. fuse.

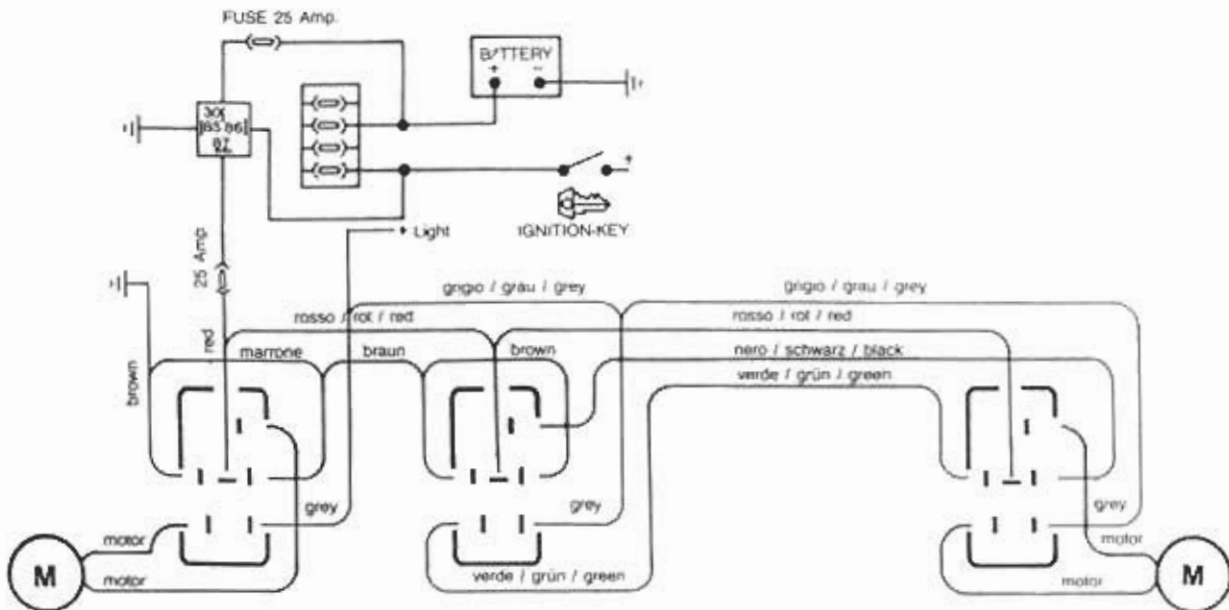

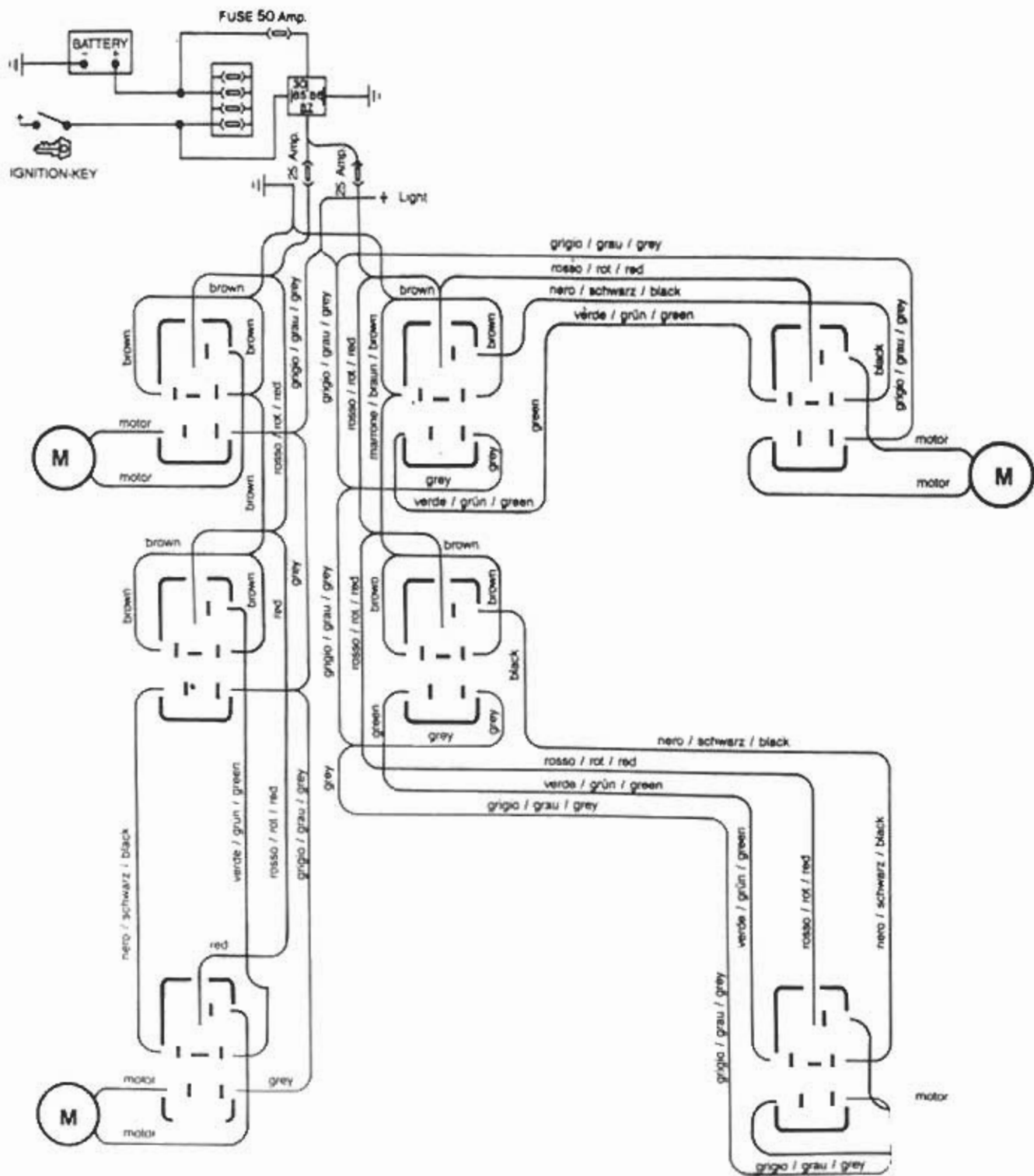

Free Manuals Download Website

<http://myh66.com>

<http://usermanuals.us>

<http://www.somanuals.com>

<http://www.4manuals.cc>

<http://www.manual-lib.com>

<http://www.404manual.com>

<http://www.luxmanual.com>

<http://aubethermostatmanual.com>

Golf course search by state

<http://golfingnear.com>

Email search by domain

<http://emailbydomain.com>

Auto manuals search

<http://auto.somanuals.com>

TV manuals search

<http://tv.somanuals.com>