

# XM Xpress<sup>RCi</sup>

## User Guide



**SIRIUS** | XM | ((XM))  
S A T E L L I T E R A D I O



# Table of Contents

<b>Introduction</b> . . . . .	<b>5</b>	<b>Special Features</b> . . . . .	<b>71</b>
Features . . . . .	6	Pause and Replay . . . . .	72
Safety and Care Information . . . . .	7	TuneSelect . . . . .	74
What's in the Box? . . . . .	9	GameSelect . . . . .	77
Xpress <sup>RCi</sup> Functions . . . . .	10	Stock Quotes . . . . .	80
Remote Control Functions . . . . .	11	SongSaver . . . . .	82
Control Knob and Select Button Basics . . . . .	12		
PowerConnect Vehicle Dock . . . . .	13		
<b>Vehicle Installation</b> . . . . .	<b>15</b>	<b>Where Else Can You Use Your Xpress<sup>RCi</sup>? . . . . .</b>	<b>85</b>
Step 1: Choose a Location for Your Radio . . . . .	16	<b>Configuring your Xpress<sup>RCi</sup> . . . . .</b>	<b>87</b>
Step 2: Install the Dash or Vent Mount . . . . .	18	Radio ID . . . . .	88
Step 3: Mount the Magnetic Mount Antenna . . . . .	22	Find Available FM Channels in Your Area . . . . .	89
Step 4: Route the Magnetic Mount Antenna Cable . . . . .	27	Turn FM Transmitter On/Off . . . . .	92
Step 5: Connect the Magnetic Mount Antenna and PowerConnect Power Adapter . . . . .	39	Set and Select FM Channels . . . . .	94
Step 6: Connect the Audio . . . . .	40	Set Audio Level . . . . .	97
		Signal Indicator . . . . .	98
		Display Settings . . . . .	99
		Set Time . . . . .	101
		Sleep Timer . . . . .	105
		Factory Settings . . . . .	106
		Demo Mode . . . . .	107
<b>Activation</b> . . . . .	<b>53</b>	<b>Troubleshooting</b> . . . . .	<b>109</b>
<b>Using your Xpress<sup>RCi</sup> . . . . .</b>	<b>55</b>	<b>Product Specifications . . . . .</b>	<b>115</b>
The Main Display . . . . .	56	Patent Information . . . . .	118
Navigation Basics . . . . .	58	Environmental Information . . . . .	118
Listening to Satellite Radio . . . . .	61	Owner's Record . . . . .	121
FM Presets . . . . .	67		
Skip a Channel . . . . .	68		
Block xL (Explicit Language) Channels . . . . .	69		





# Introduction

## Features

### **Congratulations on your purchase of the Xpress<sup>RCi</sup>!**

The Xpress<sup>RCi</sup> has these exciting features to enhance your overall experience:

- **Large vibrant color display:** View artist name, song title, and channel information on a display with stylish color backgrounds and graphics.
- **Split screen display mode:** Split the screen to simultaneously view what's playing on the current channel and up to 3 other channels, or view what's playing on the current channel and the last channel you were listening to at the same time.
- **Improved audio connection options:** Use either the included Aux In Cable, or the new *PowerConnect* technology to receive audio through your vehicle's stereo system.
- **Enhanced real-time channel guide:** Browse programs, artists, and songs playing on other channels, without having to change the channel you are on.
- **Pause and Replay:** Pause, rewind, and replay up to 60 minutes of live radio.
- **TuneSelect and GameSelect:** Don't miss your favorite artists and songs when they are on live radio. And view scores and stats of your teams anytime, plus get alerts when they are playing.
- **SongSaver:** Store up to 10 songs so you can listen to them later.
- **Stock Ticker:** Track the price and daily movement of your favorite stocks.

**Please read the entire user guide before using your Xpress<sup>RCi</sup> !**

## Safety and Care Information



**IMPORTANT!** Always read and understand all the instructions to avoid injury to yourself and/or damage to your device. SIRIUS XM Radio Inc. disclaims all responsibility for damage from data loss due to breakdown, repair, or other causes.

- Do not expose to extreme temperatures (above 140°F or below -4°F, or above 60°C or below -20°C).
- Do not expose to moisture. Do not use device near or in water. Do not touch the device with wet hands.
- Do not let any foreign matter spill into device.
- Do not store in dusty areas.
- Do not expose to chemicals such as benzene and thinners. Do not use liquid or aerosol cleaners. Clean with a soft damp cloth only.
- Do not expose to direct sunlight for a prolonged period of time, and do not expose to fire, flame, or other heat sources.
- Do not try to disassemble and/or repair device yourself.
- Do not drop your device or subject it to severe impact.
- Do not place heavy objects on device.
- Do not subject device to excessive pressure.
- If the LCD screen is damaged, do not touch the liquid crystal fluid.

# Introduction

## Warning!

- Opening the case may result in electric shock.
- If the liquid crystal fluid comes in contact with your skin, wipe the skin area with a cloth and then wash the skin thoroughly with soap and running water. If the liquid crystal fluid comes into contact with your eyes, flush the eyes with clean water for at least 15 minutes and seek medical care. If the liquid crystal fluid is ingested, flush your mouth thoroughly with water. Drink large quantities of water, and induce vomiting. Seek medical care.
- Make sure that you insert the *PowerConnect* Power Adapter all the way into the vehicle's cigarette lighter or power adapter socket.
- If you are using *PowerConnect* as your audio connection option, it is advisable not to insert a multi-outlet adapter into the same vehicle cigarette lighter or power adapter socket to simultaneously power other devices. Some multi-outlet adapters can prevent the *PowerConnect* feature from working properly.
- When using this product, it is always important to keep your eyes on the road and hands on the wheel. Not doing so could result in personal injury, death, and/or damage to your device, accessories, and/or to your vehicle or other property.
- Vehicle installation and radio configuration functions should not be performed while driving. Park your vehicle in a safe location before beginning installation.
- This product contains chemicals known to the State of California to cause cancer and birth defects or other reproductive harm.

Your device should be placed in your vehicle where it will not interfere with the function of safety features, e.g., deployment of airbags. Failure to correctly place device may result in injury to you or others, if the unit becomes detached during an accident and/or obstructs the deployment of an airbag.



## What's in the Box?

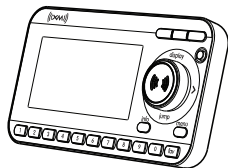

Xpress<sup>RCi</sup> Radio

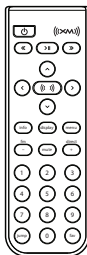

Remote Control



Aux In Cable

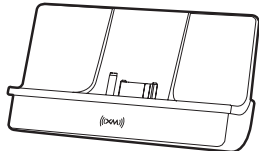

PowerConnect Vehicle Dock

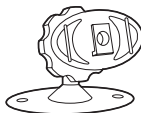

Dash Mount

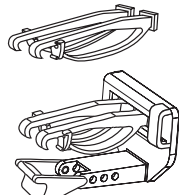

Vent Mount  
and Extended  
Vent Clamps

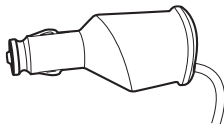

PowerConnect  
Power Adapter

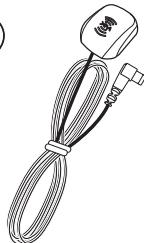

Magnetic Mount  
Antenna



Antenna & Dash Mount  
Alcohol Preparation Pads

# Introduction

## Xpress<sup>RCi</sup> Functions

### Control Knob

Scroll through lists and preview channels; also highlight menu options.

### Pause and Replay Buttons

Pause, rewind, and replay up to 60 minutes of live radio.

### Display

Customize the way you view content on the display.

### Power Button

Turn radio on and off.

### Select Button

Press to confirm selection for channel and menu items; also press and hold to GameSelect, to TuneSelect, or to save a song.

### Left and Right Arrows

Search for channels by category; also when in Replay mode, rewind or fast-forward through content.

### Menu Button

Access advanced features and configuration options; also press and hold to access FM presets.

### Fav Button

Choose among the different tuning modes: Direct, Favorite Channels, and SongSaver.

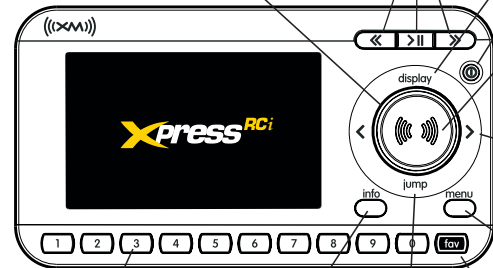

### Number Buttons

Select your favorite channels; also enter a channel number directly; also access songs saved in SongSaver.

### Info Button

View either sports or stock information.

### Jump

Go back to the previous channel to which you were listening.

## Remote Control Functions

### Power Button

Turn radio on and off.

### Pause and Replay Buttons

Pause, rewind, and replay up to 60 minutes of live radio.

### Select Button

Press to confirm selection for channel and menu items; also press and hold to GameSelect, or to save a song.

### Info Button

View either sports or stock information.

### - / FM Button

-: Change channels, or decrease volume for Sound System (sold separately).

FM: Not used in Xpress<sup>RCi</sup>.

### Number Buttons

Select your favorite channels; also enter a channel number directly; also access songs saved in SongSaver.

### Jump Button

Go back to the previous channel to which you were listening.

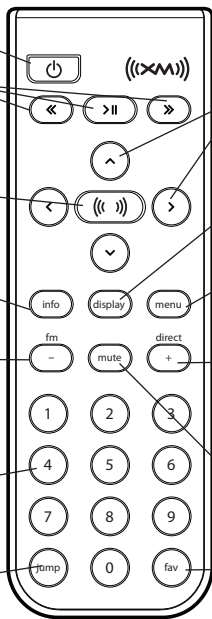

### Arrow Buttons

Use up/down arrow buttons to scroll through lists and preview channels; also highlight menu options. Use left/right arrows to search for channels by category; also when in Replay mode, rewind or fast-forward through content.

### Display Button

Customize the way you view content on the display.

### Menu Button

Access advanced features and configuration options; also press and hold to access FM presets.

### + / Direct Button

+: Change channels, or increase volume for Sound System (sold separately).

Direct: Not used in Xpress<sup>RCi</sup>.

### Mute Button

Silence live radio, saved songs, and replayed content.

### Fav Button

Choose among the different tuning modes: Direct, Favorite Channels, and SongSaver.

# Introduction

## Control Knob and Select Button Basics

Turn the **Control knob** clockwise or counter-clockwise to scroll through a list and highlight an item in the list.



Press the center of the **Select button** to make a selection.

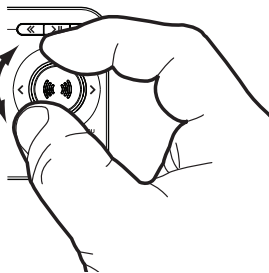

Press the edge to tilt the **Select button** to select **>**, **<**, **display**, or **jump**.

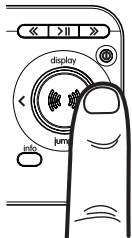

Tilt Right: **>**

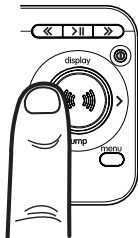

Tilt Left: **<**

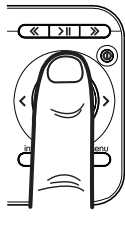

Tilt Up: **display**

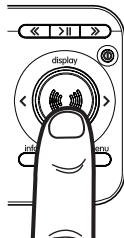

Tilt Down: **jump**

## PowerConnect Vehicle Dock

### Color-Coded Connections

The color-coded *PowerConnect* Vehicle Dock makes it simple to connect. Just match the colors on the cable ends to the colors on the dock to see what goes where.

Rear View

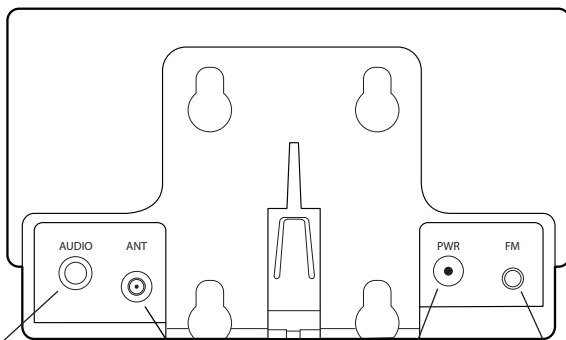

**AUDIO (Green)**  
Connection for Aux In  
Cable or optional  
Cassette Adapter  
(sold separately).

**ANT (Silver)**  
Connection for  
the Magnetic  
Mount Antenna.

**PWR (Red)**  
Connection for  
*PowerConnect*  
Power Adapter.

**FM (Blue)**  
Connection for  
optional FM Direct  
Adapter (sold  
separately).

# Introduction

## Wire Guide

The *PowerConnect Vehicle Dock* has a wire guide at the top rear that can help you to organize the cables and wires connected to the dock. If you need to bring a cable or wire from one side of the dock to the other, utilize the wire guide by looping the cable through the wire guide as shown.

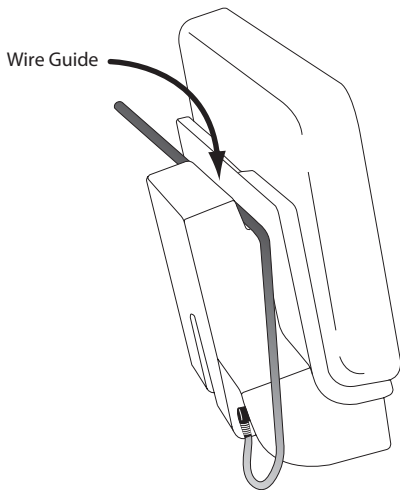

# Vehicle Installation

# Vehicle Installation

## Step 1: Choose a Location for Your Radio

When installing the Xpress<sup>RCi</sup> in your vehicle, choose a location where it will not block your vision, interfere with the controls, or obstruct the air bag. The location should be easily accessible and provide good visibility of the display, and should not be located where it will be in direct sunlight, which will affect the visibility of the the display screen.

Several examples of the Xpress<sup>RCi</sup> mounted in a vehicle are shown: **A** is the on dash method using the Dash Mount, and **B** is the vent clip method using the Vent Mount.

Option 1

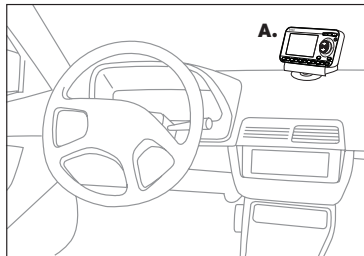

Option 2

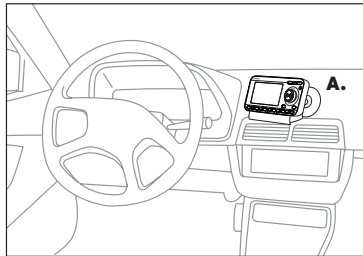



Option 3

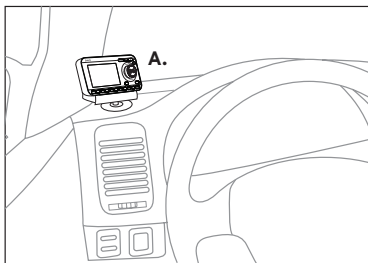

Option 4

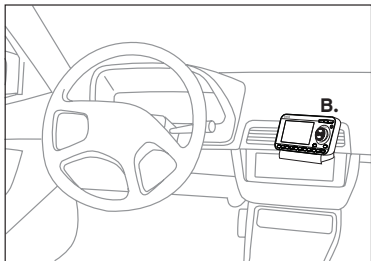

Option 5

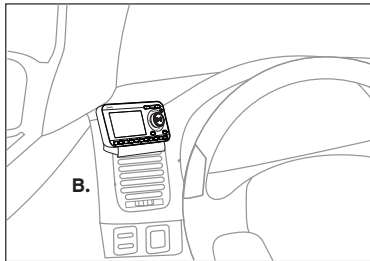

# Vehicle Installation

## Step 2: Install the Dash or Vent Mount

Depending on your situation, you can either choose to use the Dash Mount or the Vent Mount.



**IMPORTANT!** When you install the chosen mount, do not attach the dock to the mount yet. All cables should be attached to the dock prior to connecting the dock to the mount.

### *Installing the Dash Mount:*



**CAUTION!** The adhesive used on the Dash Mount may be difficult to remove. Do not install this mount on leather surfaces (contact your vehicle dealer if you are unsure about your dash surface), and make sure the air temperature is at least 60°F (15°C) during installation. If it's not at least 60°F, turn on the heater in your vehicle to bring the temperature up to 60°F.

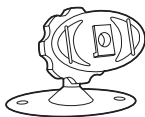

- 1 Locate a flat surface for the Dash Mount. Make sure there is ample room for the *PowerConnect* Vehicle Dock and *Xpress<sup>RCi</sup>* Radio when installed.
- 2 Set the orientation of the Dash Mount before adhering it. Loosen the knob and adjust the adhesive foot for the location you selected in "Step 1: Choose a Location for Your Radio" on page 16:
  - Option 1 & Option 3 should be oriented as **I**.
  - Option 2 should be oriented as **II**.

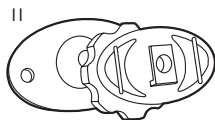
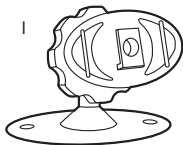

- 3** The dock mounting plate can be tilted in different directions. Adjust as necessary for your particular vehicle. When the orientation is correct, tighten the knob.

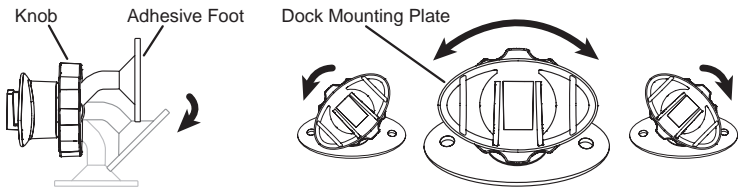

- 4** Clean the surface with the alcohol preparation pad and let it dry thoroughly.
- 5** Peel off the adhesive liner. Position, press, and hold the Dash Mount in place for 30 seconds.

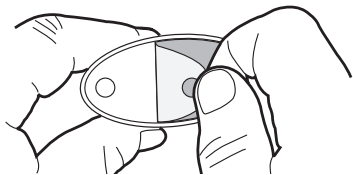

**IMPORTANT!** Allow the Dash Mount adhesive to cure (dry) for a minimum of 2-4 hours before using the mount. The best adhesion occurs after 24 hours.



**TIP!** To remove, carefully lift the adhesive pad with your fingers or a spoon. Warming the pad with a hair dryer for several minutes will help soften the adhesive. Be careful not overheat the surface with the hair dryer or you may damage the surface or Dash Mount.

# Vehicle Installation

## Installing the Vent Mount:

- 1 Locate a vent with horizontal louvers sturdy enough to hold your PowerConnect Vehicle Dock and radio.
- 2 If the vent louvers in your vehicle are recessed, you may need to use the longer vent clamps with the Vent Mount. If so, remove the shorter vent clamps and install the longer ones into the Vent Mount. Be sure to observe the orientation of the vent clamps as shown.

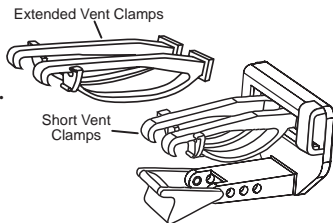

Remove End Cap

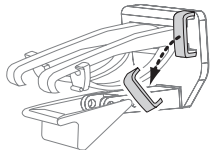

Slide Short Vent Clamps Out

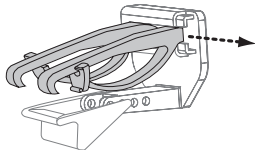

Slide Extended Vent Clamps In

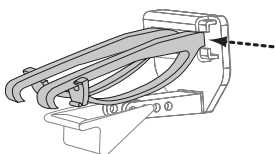

Replace End Cap

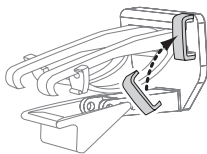

- 3** Push the Vent Mount onto the vehicle vent as shown (1) until it hooks on the rear of the vent louver (2).
- 4** Rest the foot against the bottom of the vent (2), and adjust the tilt of the Vent Mount by repositioning the foot to a different adjustment hole (3).

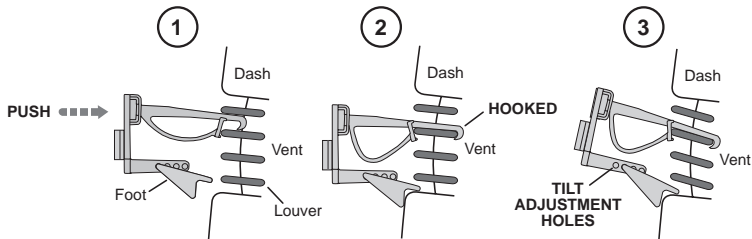

To remove the Vent Mount, push the mount into the vent. Then lift up until disengaged from the rear of the vent louver, and remove the Vent Mount.

# Vehicle Installation

## Step 3: Mount the Magnetic Mount Antenna

The Magnetic Mount Antenna contains a strong magnet which will stick to any metal part of your vehicle, but will not damage the vehicle.

*To install the Magnetic Mount Antenna:*

- 1 Choose the best location for your antenna considering your vehicle type. Pay particular attention to any accessories that you may have like luggage racks and how frequently you may use them.

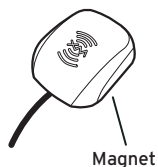

**Sedan/Coupe:** We recommend mounting the antenna just above either the front windshield or the back window as shown.

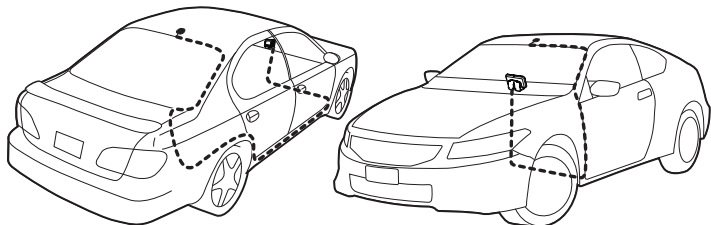

**SUV:** We recommend mounting the antenna at the rear of the roof as shown.

**Convertible:** We recommend mounting the antenna at the leading edge of the trunk as shown.

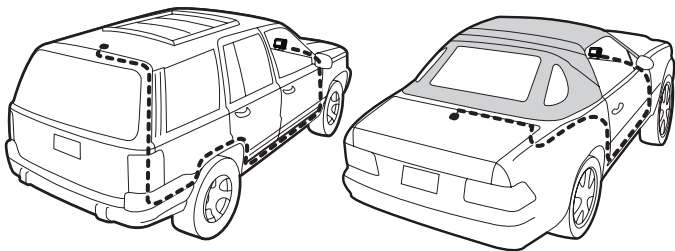

**Pickup Truck:** We recommend mounting the antenna just above the front windshield as shown.

- 2** Clean the surface of the selected mounting location using the alcohol preparation pad and let it dry thoroughly.

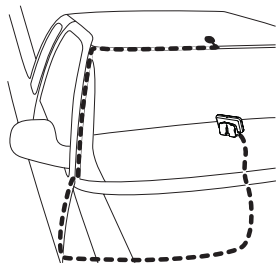

# Vehicle Installation

- 3 Place the antenna in the location you selected. Follow the Tips and Cautions shown on the next several pages.

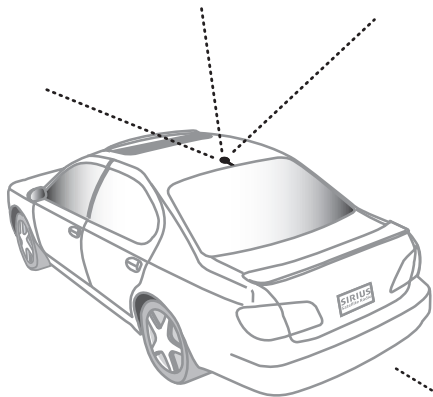

**TIP!** Mount the antenna on the roof (for most vehicles) or trunk (for convertibles) where it has a clear view of the sky in all directions.

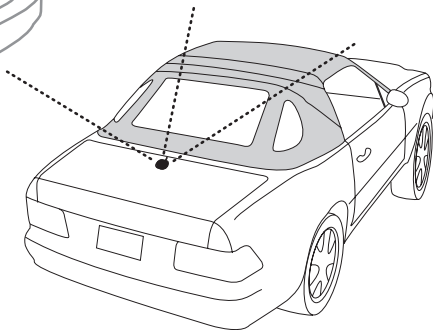





**CAUTION!** Don't mount the antenna inside the vehicle, for example, on the dashboard.

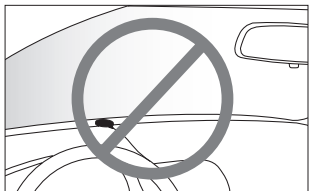

**CAUTION!** Don't mount the antenna on any of the vehicle's front, back or side pillars.

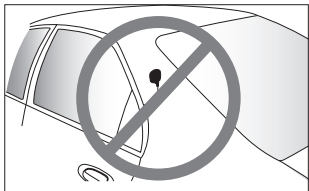

**CAUTION!** Don't mount the antenna close to a roof rack. Adjust the rack so it's further away from the antenna or move the antenna closer to the center of the roof.

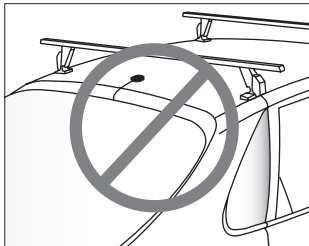

# Vehicle Installation



**CAUTION!** Don't mount the antenna close to another antenna. Mount it at least 3 inches away.

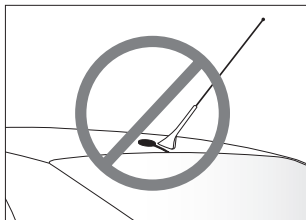

## Step 4: Route the Magnetic Mount Antenna Cable

Before you begin routing the antenna cable, read these general instructions for how to route and hide the antenna cable. Then route your antenna cable according to the instructions which follow for your specific type of vehicle.

Use a blunt plastic putty knife, a credit card, a plastic knife, or a similar blunt tool to lift the rubber window moulding

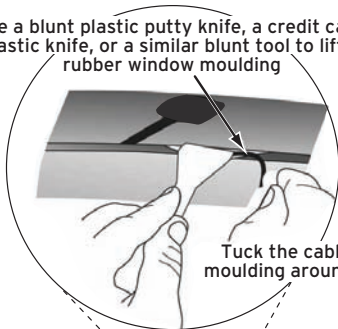

Tuck the cable under the moulding around the window

Feed cable under rubber moulding around window

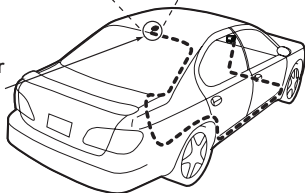

# Vehicle Installation

Route cable out from under rear windshield moulding and tuck into weatherstripping around trunk opening  
Avoid sharp bends by running cable through weatherstripping for several inches

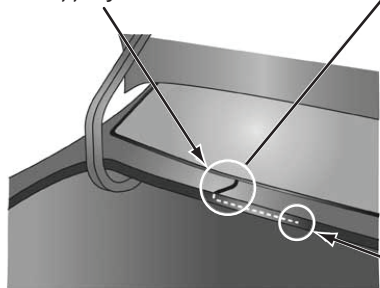

  
Pull weatherstripping from trunk opening

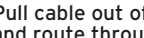

Tuck cable into weatherstripping.  
Route cable through weatherstripping several inches to avoid sharp bends

  
Pull cable out of weatherstripping and route through trunk to cabin

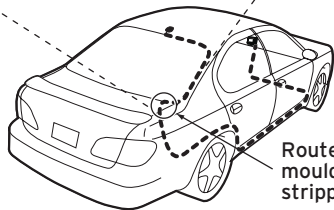

Route cable out of window moulding and into weatherstripping around trunk opening

Bring cable out of weatherstripping and into trunk

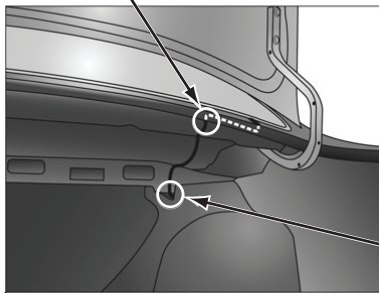

Route cable along trunk wall and into cabin through gap or conduit, along existing wiring harness

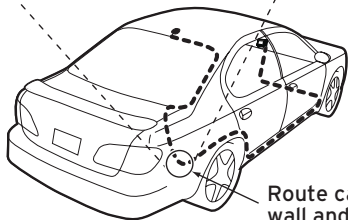

Route cable along trunk wall and into cabin

# Vehicle Installation

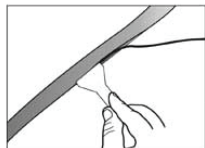

Use a blunt plastic putty knife or similar blunt tool to lift edge of interior trim and tuck cable under trim. Continue towards front of vehicle

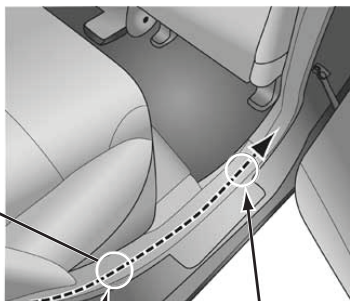

Route cable under trim or upholstery

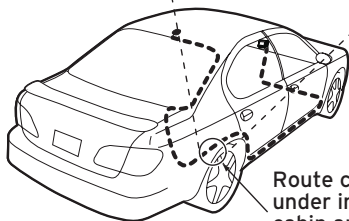

Route cable from trunk under interior trim, into cabin and towards front of vehicle

Continue routing cable under trim or carpet towards front of vehicle

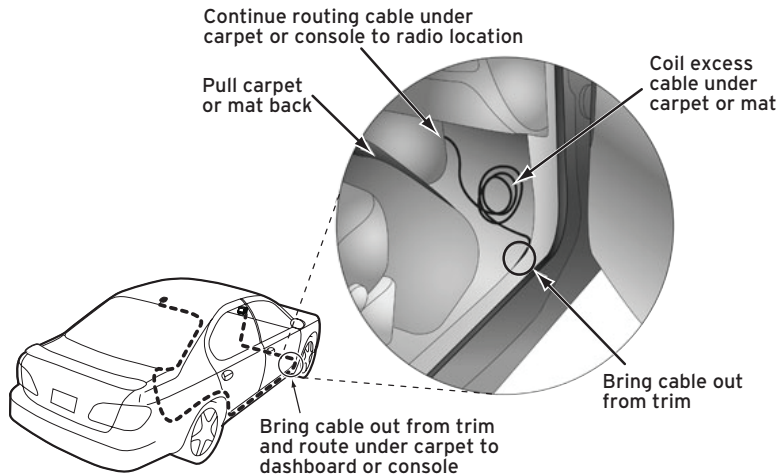

**TIP!** Always be careful to include enough slack in your cable to accommodate open doors or trunk lids. Use things typically found around the home, like electrical tape, to secure cables in areas so that hinges do not pinch the cable with the door. Hide any excess cable in the trim.

# Vehicle Installation

- **Sedan/Coupe With the Antenna Placed at the Rear of the Roof:**

1. Feed the antenna cable from the antenna underneath the rubber molding around the rear window. Use a blunt plastic putty knife or similar blunt tool to lift the rubber molding around the rear window and tuck the antenna cable underneath the molding. Route the antenna cable around and down the window to the lowest point. If your rear window does not have rubber molding, we recommend consulting a professional installer.
2. Route the antenna cable out of the window molding and into the rubber weather stripping around the trunk opening. Lift the weather stripping from the opening and tuck the cable inside it, then replace the weather stripping. To avoid sharp bends in the cable, run the cable inside the weather stripping for a few inches, then remove the cable from the weather stripping inside the trunk. Keep the cable away from hinges, gears, etc., that could damage it.
3. Route the cable out from the rubber weather stripping and along the trunk wall. Continue routing the cable into the vehicle cabin through a conduit or along an existing wiring harness.
4. Route the cable through the main cabin area under the interior trim, towards

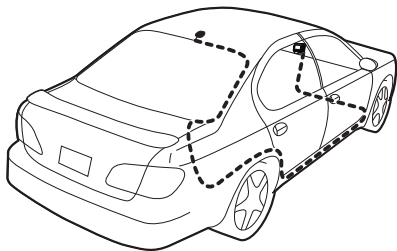



the front of the vehicle. Use a blunt plastic putty knife or similar blunt tool to lift the plastic trim just enough to tuck the cable under underneath. Avoid side airbag locations on back pillars and above the doors. Airbag locations are marked with "SRS" logos. Be careful not to crimp or cut the cable.

5. Bring the cable out from the trim near the front of the cabin and route it under the carpet toward the dashboard or console. Coil any excess cable in a hidden location, such as under the carpet, keeping it away from any vehicle pedals or controls. Secure the excess cable with wire ties (purchased separately).
6. Bring the end of the cable out at the *PowerConnect* Vehicle Dock location. Leave yourself enough cable so you can easily connect it to the antenna connector of the dock.
7. Continue with "Step 5: Connect the Magnetic Mount Antenna and *PowerConnect* Power Adapter" on page 39.

# Vehicle Installation

- **Sedan/Coupe With the Antenna Placed at the Front of the Roof:**

1. Feed the antenna cable from the antenna underneath the rubber molding around the windshield. Use a blunt plastic putty knife or similar blunt tool to lift the rubber molding around the windshield and tuck the antenna cable underneath the molding. Route the antenna cable around and down the windshield to the lowest point.
2. At the lowest corner of the windshield, route the cable out of the windshield molding and into the rubber weather stripping around the door opening. Lift the weather stripping from the opening and tuck the cable inside it, then replace the weather stripping. Run the cable inside of the weather stripping to the bottom of the door opening.
3. Pull the cable out of the weather stripping at the bottom of the door opening and route it under the carpet toward the dashboard. Coil any excess cable in a hidden location, such as under the carpet, keeping it away from any vehicle pedals or controls. Secure the excess cable with wire ties.
4. Bring the end of the cable out at the *PowerConnect Vehicle Dock* location. Leave yourself enough cable so you can easily connect it to the antenna connector of the dock.
5. Continue with "Step 5: Connect the Magnetic Mount Antenna and *PowerConnect Power Adapter*" on page 39.

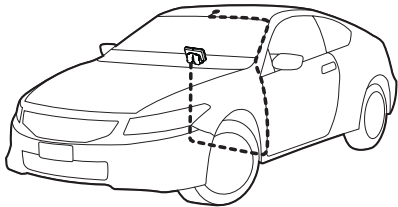

• **SUV:**

1. Feed the antenna cable underneath the rubber weather stripping of the rear tailgate window/door and route the cable along the rear hatch. Lift the weather stripping from the opening and tuck the cable inside it, then replace the weather stripping. Pull the cable out from weather stripping and route it into the cabin under the interior trim. Avoid hinges or gears that could crimp or cut the cable.
2. Route the cable through the SUV's main cabin area under the interior trim, towards the front of the vehicle. Use a blunt plastic putty knife or similar blunt tool to lift the plastic trim just enough to tuck the cable under underneath. Avoid side airbag locations on back pillars and above the doors. Airbag locations are marked with "SRS" logos. Be careful not to crimp or cut the cable.
3. Bring the cable out from the trim near the front of the cabin and route it under the carpet toward the dashboard or console. Coil any excess cable in a hidden location, such as under the carpet, keeping it away from any vehicle pedals

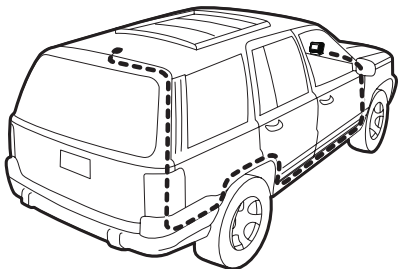

# Vehicle Installation

or controls. Secure the excess cable with wire ties (purchased separately).

4. Bring the end of the cable out at the *PowerConnect Vehicle Dock* location. Leave yourself enough cable so you can easily connect it to the antenna connector of the dock.
5. Continue with "Step 5: Connect the Magnetic Mount Antenna and *PowerConnect Power Adapter*" on page 39.

## • Convertible:

1. Bring the antenna cable from the antenna into the trunk at the front edge of the trunk lid. Keep any bends in the cable loose. Tape or tie the cable along the inside of the trunk lid to the trunk lid hinge strut.
2. Allow enough slack in the cable so the trunk lid can easily open and close and keep the cable away from hinges, gears, etc., that could crimp or cut it. Route the cable along the trunk wall and into the cabin through a conduit or along an existing wiring harness.
3. Route the cable through the main cabin area under the interior trim, towards the front of the vehicle. Use a blunt plastic putty knife or similar blunt tool to lift the plastic trim just enough to tuck the cable under underneath. Avoid side

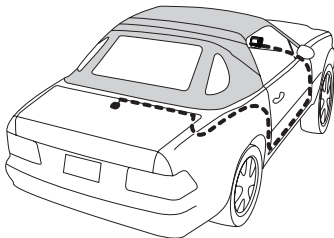

airbag locations on back pillars and above the doors. Airbag locations are marked with "SRS" logos. Be careful not to crimp or cut the cable.

4. Bring the cable out from the trim near the front of the cabin and route it under the carpet toward the dashboard or console. Coil any excess cable in a hidden location, such as under the carpet, keeping it away from any vehicle pedals or controls. Secure the excess cable with wire ties (purchased separately).
5. Bring the end of the cable out at the *PowerConnect Vehicle Dock* location. Leave yourself enough cable so you can easily connect it to the antenna connector of the dock.
6. Continue with "Step 5: Connect the Magnetic Mount Antenna and *PowerConnect Power Adapter*" on page 39.

• **Pickup Truck:**

1. Use a blunt plastic putty knife or similar blunt tool to lift the rubber molding around the windshield and tuck the antenna cable underneath it.
2. Continue tucking the cable underneath the windshield molding around the windshield to the lowest corner.
3. At the lowest corner of the windshield, route the cable out

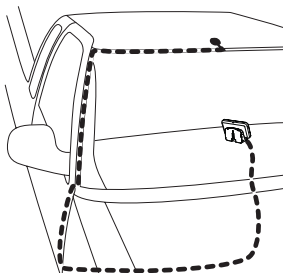

# Vehicle Installation

of the windshield molding and into the rubber weather stripping around the door opening. Lift the weather stripping from the opening and tuck the cable inside it, then replace the weather stripping. Run the cable inside of the weather stripping to the bottom of the door opening.

4. Pull the cable out of the weather stripping at the bottom of the door opening and route it under the carpet toward the dashboard. Coil any excess cable in a hidden location, such as under the carpet, keeping it away from any vehicle pedals or controls. Secure the excess cable with wire ties.
5. Bring the end of the cable out at the *PowerConnect* Vehicle Dock location. Leave yourself enough cable so you can easily connect it to the antenna connector of the dock.
6. Continue with “Step 5: Connect the Magnetic Mount Antenna and *PowerConnect* Power Adapter” on page 39.

## Step 5: Connect the Magnetic Mount Antenna and PowerConnect Power Adapter

- 1 Plug the Magnetic Mount Antenna into the **silver ANT** connector on the *PowerConnect* Vehicle Dock.

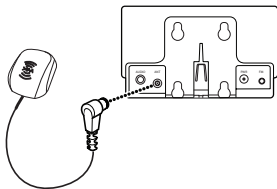

- 2 Insert the *PowerConnect* Power Adapter into your vehicle's cigarette lighter or power adapter socket.

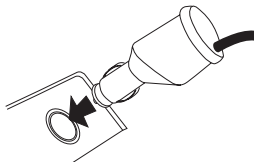

- 3 Plug the *PowerConnect* Power Adapter into the **red PWR** connector on the dock.

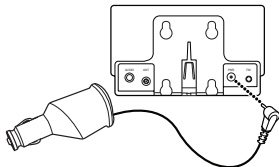

# Vehicle Installation

## Step 6: Connect the Audio

To play audio through your vehicle's stereo or FM radio, decide on one of the following audio connection options:

- **Option 1: Best:** Use the **Aux In Cable** if your vehicle's stereo system has an auxiliary input connection. Refer to your vehicle's owners manual to find the location of the auxiliary input jack, or consult the vehicle dealer.



**TIP!** The auxiliary input jack may be located on the face plate of the vehicle radio, on the back of the radio, anywhere on the front dash panel, inside the glove compartment, or inside the center console in between the front seats.

- **Option 2: Better:** Use a **Cassette Adapter** if your vehicle has a built-in cassette player. Cassette Adapters are sold separately and can be purchased from an electronics retailer, or go to [xmradio.com/accessories](http://xmradio.com/accessories).
- **Option 3: Good:** Use the **PowerConnect** feature in the Xpress<sup>RCi</sup>. PowerConnect plays the audio through your vehicle's FM radio.
- **Option 4: Best:** Use the **FM Direct Adapter**. If none of the previous three audio connection options will work in your vehicle, then you will need to use the FM Direct Adapter (FMDA) (sold separately). The FMDA needs to be installed by a professional installer and directly connects the Xpress<sup>RCi</sup> to your vehicle's FM radio. To learn more, check with the retailer where you bought your radio, or go to [xmradio.com/accessories](http://xmradio.com/accessories).

Follow the installation instructions in the next several sections for the audio connection option that you have selected.



## Option 1: Aux In Cable Installation Instructions

- 1 Plug one end of the Aux In Cable into the **green AUDIO** connector on the dock.

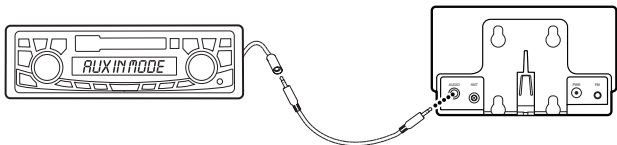

- 2 Plug the other end into the auxiliary input jack connection of your vehicle's stereo system.
- 3 Insert the dock into the mount.
- 4 Insert your Xpress<sup>RCi</sup> into the dock.

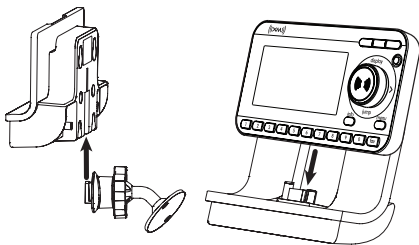

- 5 By default, your Xpress<sup>RCi</sup> turns on automatically when it is plugged in and receiving power. If it does not, power on your Xpress<sup>RCi</sup> by pressing the **Power button**.



**NOTE!** You may experience a brief delay while your Xpress<sup>RCi</sup> powers up. If you press the **Power button** during this time, you will see a "Please Wait" message.

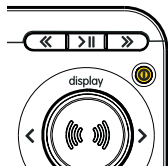

# Vehicle Installation

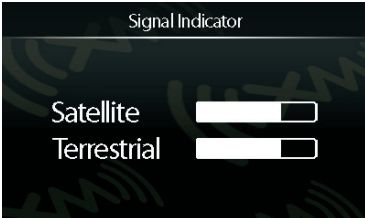
- 6 Be sure the vehicle is outside and the antenna has a clear view of the sky. Verify that you are receiving the XM signal. There should at least be one bar on the upper right corner of the main display screen that denotes antenna signal strength. You can also press **menu** and scroll down to highlight **Signal Indicator** and press the **Select button**. The Satellite and Terrestrial bars show the strength of the signal being received. If the signal reception is good, press **menu** twice to return to the main display screen.
- 
- The screenshot shows a screen titled "Signal Indicator" with a dark background. There are two horizontal bars representing signal strength. The top bar is labeled "Satellite" and the bottom bar is labeled "Terrestrial". Both bars are filled with white, indicating a strong signal, and each has a small black square at the right end.
- 7 Ensure that the FM Transmitter is turned Off. Xpress<sup>RCi</sup> is shipped with FM Transmitter turned Off as the default. However, you can refer to "Turn FM Transmitter On/Off" on page 92, if you want to verify that the FM Transmitter is set to Off.
  - 8 Ensure that Xpress<sup>RCi</sup> is tuned to channel 1. Upon power up, Xpress<sup>RCi</sup> should tune to channel 1 by default, when it's not yet activated. If it's not on channel 1, refer to "Listening to Satellite Radio" on page 61 to learn about how to tune a channel.
  - 9 Turn on your vehicle's stereo system. Set it to play input from the auxiliary input source.
  - 10 You should hear XM channel 1 through your vehicle's stereo system. You are now ready to activate your Xpress<sup>RCi</sup>.

- 11** The audio level output of the Xpress<sup>RCI</sup> can be increased or decreased as necessary to match the audio levels of other sources in your vehicle. Refer to "Set Audio Level" on page 97.

If the signal reception is good, but there is no audio when tuned to channel 1, be sure the vehicle's stereo system is set to the correct source, i.e., auxiliary input source (step 9). Also be sure that the FM Transmitter is turned Off (step 7), and that the audio level is set high enough to be heard (step 11). Refer to "Troubleshooting" on page 110 for additional help.

# Vehicle Installation

## Option 2: Cassette Adapter Installation Instructions

- 1 Plug the Cassette Adapter into the **green AUDIO** connector on the dock.
- 2 Insert the Cassette Adapter into the vehicle's cassette deck. You may need to turn on your vehicle's stereo in order to do so.
- 3 Insert the dock into the mount.
- 4 Insert your Xpress<sup>RCi</sup> into the dock.
- 5 By default, your Xpress<sup>RCi</sup> turns on automatically when it is plugged in and receiving power. If it does not, power on your Xpress<sup>RCi</sup> by pressing the **Power button**.

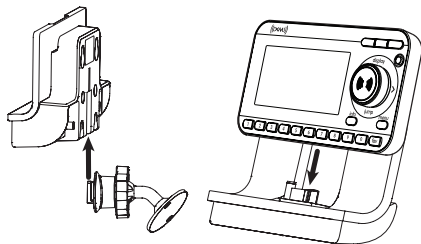
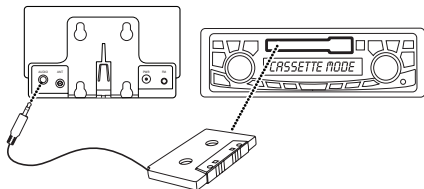

**NOTE!** You may experience a brief delay while your Xpress<sup>RCi</sup> powers up. If you press the **Power button** during this time, you will see a "Please Wait" message.

- 6 Be sure the vehicle is outside and the antenna has a clear view of the sky. Verify that you are receiving

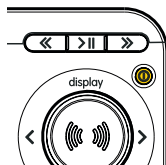

the XM signal. There should at least be one bar on the upper right corner of the main display screen that denotes antenna signal strength. You can also press **menu** and scroll down to highlight **Signal Indicator** and press the **Select** button.

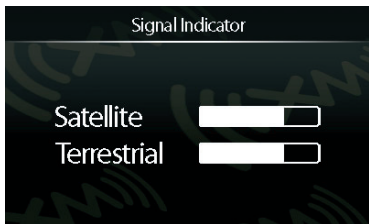

The Satellite and Terrestrial

bars show the strength of the signal being received. If the signal reception is good, press **menu** twice to return to the main display screen.

- 7 Ensure that the FM Transmitter is turned Off. Xpress<sup>RCi</sup> is shipped with FM Transmitter turned Off as the default. However, you can refer to "Turn FM Transmitter On/Off" on page 92, if you want to verify that the FM Transmitter is set to Off.
- 8 Ensure that Xpress<sup>RCi</sup> is tuned to channel 1. Upon power up, Xpress<sup>RCi</sup> should tune to channel 1 by default, when it's not yet activated. If it's not on channel 1, refer to "Listening to Satellite Radio" on page 61 to learn about how to tune a channel.
- 9 If you haven't done so, turn on your vehicle's stereo system. Set it to play input from the cassette source.
- 10 You should hear XM channel 1 through your vehicle's stereo system. You are now ready to activate your Xpress<sup>RCi</sup>.

# Vehicle Installation

- 11** The audio level output of the Xpress<sup>RCi</sup> can be increased or decreased as necessary to match the audio levels of other sources in your vehicle. Refer to "Set Audio Level" on page 97.

If the signal reception is good, but there is no audio when tuned to channel 1, be sure the vehicle's stereo system is set to the correct source, i.e., cassette source (step 9). Also be sure that the FM Transmitter is turned Off (step 7), and that the audio level is set high enough to be heard (step 11). Refer to "Troubleshooting" on page 110 for additional help.

## Option 3: PowerConnect Installation Instructions

- 1 Insert the dock into the mount.
- 2 Insert your Xpress<sup>RCi</sup> into the dock.
- 3 By default, your Xpress<sup>RCi</sup> turns on automatically when it is plugged in and receiving power. If it does not, power on your Xpress<sup>RCi</sup> by pressing the **Power button**.

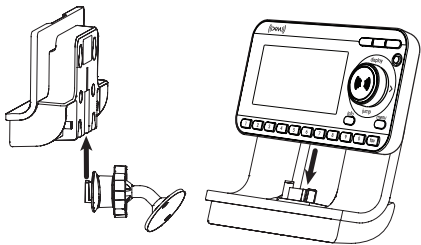

**NOTE!** You may experience a brief delay while your Xpress<sup>RCi</sup> powers up. If you press the **Power button** during this time, you will see a "Please Wait" message.

- 4 Be sure the vehicle is outside and the antenna has a clear view of the sky. Verify that you are receiving the XM signal. There should at least be one bar in the upper right corner of the main display screen that denotes antenna signal strength. You can also press **menu** and scroll down to highlight **Signal Indicator** and press the **Select button**.

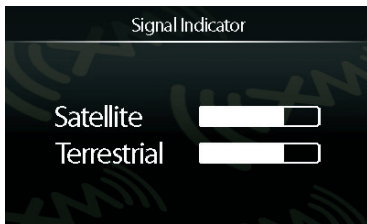
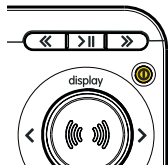

# Vehicle Installation

The Satellite and Terrestrial bars show the strength of the signal being received. If the signal reception is good, press **menu** twice to return to the main display screen.

- 5** You'll first need to find an available FM channel. An available FM channel is one that's not being used by an FM radio station in your area. When you tune your FM radio to an available channel, you should only hear static or silence - not talk or music. We recommend one of the following methods to find an available FM channel:

- f. Use the SIRIUS | XM FM Channel Finder at [www.xmradio.com/fmchannel](http://www.xmradio.com/fmchannel). Go to the website and enter your zip code. The Channel Finder will suggest a list of available FM channels in your area. For convenience, write down or print out the list.

OR

- g. Manually tune through your local FM channels on your vehicle's FM radio. Locate and create a list of channels that aren't being used by any FM radio station. Write down the list. Once you have created your list of available FM channels, you will need to find the one that provides the best match for Xpress<sup>RCI</sup>.



**TIP!** You'll need to use the 'Manual' tune function on your vehicle's FM radio to tune through every FM channel one-by-one. Turn on your vehicle's FM radio. Start at 88.1 and use the 'Manual' tune function on your vehicle's FM radio to tune through each FM channel one-by-one (88.1 followed by 88.3 etc.) to locate channels that aren't being used by a local FM radio station. Write down each FM channel that has only static or silence on it, until you reach 107.9.

- 6** Pick the first FM channel on your list from step 5. Turn on your vehicle's FM radio (if you have not already done so) and tune it to this FM channel.



**7** Turn On the FM Transmitter in Xpress<sup>RCi</sup>:

- i. Press **menu**.
- ii. Press the **Select button** to select **Vehicle Mode**.
- iii. Press the **Select button** to select **FM Transmitter** which will turn yellow.
- iv. Turn the **Control knob** clockwise to display **On** and press the **Select button**.

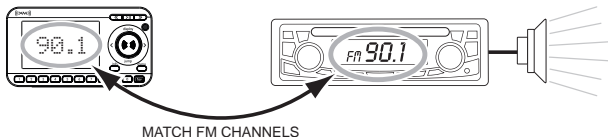
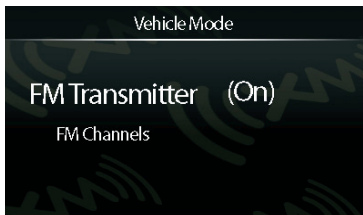

**8** Set your Xpress<sup>RCi</sup> to transmit on the same usable FM channel that you found in step 5:

- i. If you are still in the **Vehicle Mode** menu option with **FM Transmitter** turned On, skip to step iii. If not, press **menu**.
- ii. Press the **Select button** to select **Vehicle Mode**.
- iii. Turn the **Control knob** to scroll to and highlight **FM Channels**. Press the **Select button**.

# Vehicle Installation

- iv. Turn the **Control knob** to scroll to and highlight storage location **FM-2** and press the **Select button**.
- v. From the list of FM channels displayed, turn the **Control knob** to highlight the available FM channel you found in step 4, and press the **Select button**.



- vi. Press the **Select button** to select **Start Using**.
- vii. The selected FM channel will be confirmed on the display screen. The Xpress<sup>RCi</sup> will tune to the FM channel.

**9** You should hear XM channel 1 through your vehicle's FM radio. If you are satisfied with the sound quality, you're done! You are now ready to activate your Xpress<sup>RCi</sup>.

**10** If the selected FM channel doesn't work well for you, work down the list of FM channels until you find one that allows you to hear XM clearly. Each time, you will need to tune your vehicle's FM radio to the FM channel and then set your Xpress<sup>RCi</sup> to transmit on the same FM channel (steps 7 & 8).



If the signal reception is good, but there is no audio when tuned to channel 1, verify that Xpress<sup>RCI</sup>'s FM Transmitter is On (step 6), and that both the FM Transmitter and your vehicle's FM radio are tuned to the same FM channel (steps 5 & 7). Also ensure the chosen FM channel is a suitable one to use in your area (step 5). Verify that nothing is plugged into the **AUDIO** connector on the *PowerConnect* Vehicle Dock. Refer to "Troubleshooting" on page 110 for additional help.

#### **Option 4: FM Direct Adapter (FMDA) Installation**

The FMDA needs to be installed by a professional installer. Professional installation can help improve your radio's reception and significantly reduce the visibility of wires. To learn more, check with the retailer where you bought your radio, or go to [xmradio.com/accessories](http://xmradio.com/accessories).





# Activation

Before you can enjoy Commercial-Free Music, plus Sports, News, Talk & Entertainment, you need to activate your Xpress<sup>RCi</sup>.

- 1 Make sure your Xpress<sup>RCi</sup> is properly installed, turned on, and receiving the XM signal so that you can hear the audio on Channel 1.
- 2 Make a note of your XM Radio ID. You can find it:
  - On Channel 0
  - On a label on the bottom of the gift box
  - On the label on the back of your Xpress<sup>RCi</sup>



**NOTE!** The XM Radio ID does not use the letters I, O, S, or F.

- 3 Activate your service:
  - Online: Go to [www.xmradio.com](http://www.xmradio.com) and click on "ACTIVATE RADIO" in the top right corner
  - OR
  - By phone: Call 1-800-XM-RADIO (1-800-967-2346)
- 4 When your service is activated, your Xpress<sup>RCi</sup> will receive all channels you have subscribed to. At this time, if you turn the **Control knob**, you can scroll and tune other channels. Activation usually takes 10 to 15 minutes, but may take up to an hour. We recommend that your radio remain on until activated.

# Using your Xpress<sup>RCi</sup>

# Using your Xpress<sup>RCi</sup>

## The Main Display

When listening to a channel, information about the channel is displayed.

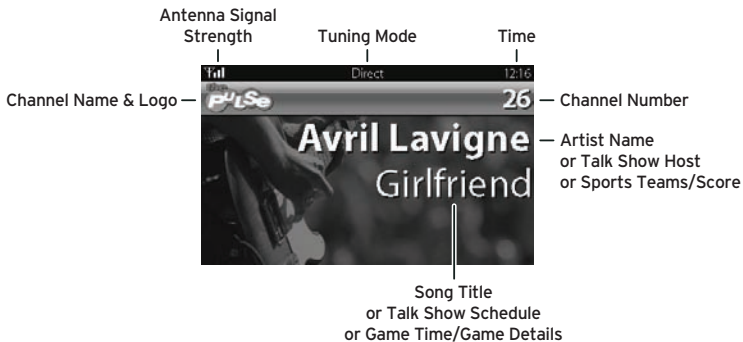



## Changing the Display Mode

You can split the screen to simultaneously view what's playing on the current channel and up to 3 other channels in any category, or view what's playing on the current channel and the last channel you had tuned at the same time.

Choose from:



main display screen with current channel

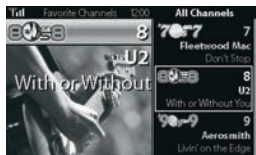

split screen with current channel and three other channels

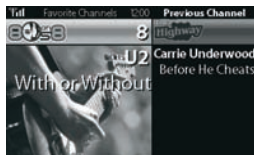

split screen with current channel and previous channel

To change the display mode, press **display**.



**TIP!** When in split screen with the channel list, you can scroll through the list of channels, just like when it appears on the full screen, by turning the **Control knob** clockwise or counter-clockwise. Press **<** or **>** to change categories. Press the **Select** button to select a channel.



**TIP!** Press **jump** to tune to previous channel that was being played.

# Using your Xpress<sup>RCi</sup>

## Navigation Basics

### Power Button



Pressing the **Power button** turns the Xpress<sup>RCi</sup> On or Off.

### Control Knob and Select Button

Navigate the Xpress<sup>RCi</sup> using the **Control knob** and **Select button**:

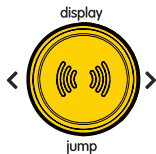

- **Control knob:** Turning it clockwise or counter-clockwise scrolls through lists and highlights an item in the list.
- **Select button (press and release):** Pressing it on the center selects a highlighted item and confirms settings.
- **Select button (press and hold):** Pressing it on the center displays the SongSaver/TuneSelect menu.

When the **Select button** is pressed at the top, bottom, left, or right edges (instead of the center), it selects **display**, **jump**, **<**, or **>** respectively.

- **Display:** Changes the display mode between main display screen and split screen.
- **Jump:** Tunes to the previous channel that was being played.
- **< or > :** Displays the channel categories such as Sports, Comedy, Rock, etc. Repeated presses cycle through the categories one at a time. In Replay mode, rewinds or fast-forwards through the temporarily stored content.

info



## Info Button

Pressing **info** toggles the display to show the sports ticker or the stock ticker at the bottom of the screen.

- **Sports Ticker:** Displays information about upcoming games and scores for games in progress that have been selected with GameSelect. Refer to “GameSelect” on page 77.
- **Stock Ticker:** Displays the stock value of up to 20 selected stocks.



**TIP!** Refer to “GameSelect” on page 77 to add sports teams to the Sports Ticker. Refer to “Stock Quotes” on page 80 to add stocks to the Stock Ticker.

menu



## Menu Button

Pressing **menu** displays various options to make setup and feature changes. Pressing **menu** when in menu options returns to the previous menu option until menu options is exited.

Pressing and holding **menu** displays the FM Channels menu, where a preset FM channel can be easily selected.

## Number Buttons



In Favorite Channels mode, each number button stores a favorite channel in its button location and provides one touch access to it afterward. In Direct mode, number buttons directly tune to a channel when the channel number is entered. In SongSaver mode, a number button plays the saved song in its button location.

# Using your Xpress<sup>RCi</sup>

## Fav Button



Pressing **fav** toggles between the different tuning modes: Direct mode, Favorite Channels mode, and SongSaver mode.

- **Direct mode:** The **0-9** buttons directly tune to a channel when the channel number is entered.
- **Favorite Channels mode:** Pressing one of the **0-9** buttons tunes to a channel that has been saved as a favorite channel to that button location.
- **SongSaver mode:** Selecting one of the **0-9** buttons plays a song that has been saved to that button location.



**TIP!** Refer to “Favorite Channels” on page 65 to learn more about Favorite Channels. Refer to “SongSaver” on page 82 to learn more about SongSaver.

## Pause and Replay Buttons



Replays up to 60 minutes of live radio. **>||** plays/pauses, **<<** rewinds, and **>>** fast-forwards through temporarily stored content.



**TIP!** Refer to “Pause and Replay” on page 72 to learn more about Pause and Replay.

## Listening to Satellite Radio

### *Tune a channel:*

- 1 Turn the **Control knob** clockwise or counter-clockwise to scroll forward or backward through the list of channels.
- 2 You'll first see the channel logo and current artist. As you pause on a channel, after a few seconds the current song title appears. While you pause, it will toggle between song title and artist name.
- 3 Press the **Select button** to select a highlighted channel.

 U2	44
 Sheryl Crow	45
 Led Zeppelin	46
 <b>★ ALT NATION</b> Red Hot Chili Pe	<b>47</b>
 <b>AL OCTANE</b> Linkin Park	48
 <b>AL KREWIND</b> David Bowie	49



**TIP!** You can configure the Xpress<sup>RCI</sup> to automatically tune to the highlighted channel after 3 seconds. Refer to "Auto Tune" on page 64 for instructions.

# Using your Xpress<sup>RCi</sup>

## View a category:

Channels are organized into categories to make it easier for you to find the ones that suit your taste.

- 1 To view a category, press < or >.
- 2 Scroll through the category to find the channel you want.
- 3 Press the **Select button** to select the channel, or press < or > to view the previous or next category.



**TIP!** To briefly listen to each channel in the category, scroll to and highlight **Scan** at the end of the category list and press the **Select button**. Refer to “Scanning Channels in a Category” on page 66 to learn more about Scan.

Rock	
 Captain Beyond	40
 Def Leppard	41
 <b>Gallows</b>	<b>42</b>
 The Kills	43
 Go Go's	44

## Direct Tune

A channel can be tuned directly by entering the channel number using the number buttons.

- 1 Before entering a channel number, put the Xpress<sup>RCI</sup> in Direct mode. Ensure "Direct" appears at the top of the display screen. If not, press **fav** until it is displayed.

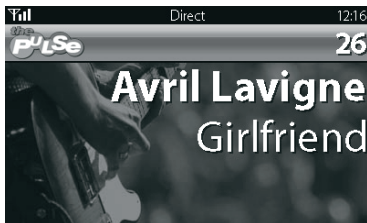

- 2 Use the number buttons (0-9) to enter the channel number and wait a moment until the channel is tuned, or press the **Select button** to immediately tune to the channel.

# Using your Xpress<sup>RCi</sup>

## Auto Tune

The Auto Tune feature allows you to tune to a channel when scrolling through the channel list, without having to press the **Select button**. When a channel is highlighted in the channel list, after 3 seconds the radio automatically tunes to that channel. The Auto Tune feature is off by default.

### *To turn Auto Tune on (or off):*

- 1 Press **menu**.
- 2 Scroll down to highlight **Channel Access** and press the **Select button**.
- 3 Press the **Select button** to select **Auto Tune** which will change to yellow.
- 4 Turn the **Control knob** clockwise until **On** is displayed (or counter-clockwise until **Off** is displayed) and press the **Select button**.

## Jump

Press **jump** to tune to the previous channel that was being played.



**TIP!** You can view what's playing on both the current channel and the previous channel at the same time. Refer to "Changing the Display Mode" on page 57.



## Favorite Channels

You can set up to 10 of your favorite channels so you can easily access them. Each favorite channel can be assigned to a number button.

### *To assign a favorite channel to a number button:*

- 1 Tune to the desired channel.
- 2 Be sure you are in Favorite Channels mode. Press **fav** until "Favorite Channels" appears at the top of the display screen.
- 3 Press and hold the number button **0-9** you want to assign to that favorite channel.

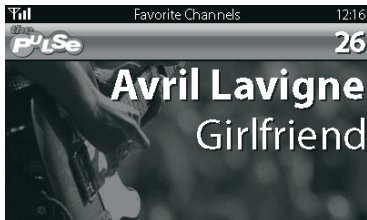

### *To listen to a favorite channel:*

- 1 Be sure you are in Favorite Channels mode. Press **fav** until "Favorite Channels" appears at the top of the display screen.
- 2 Press the number button **0-9** that was assigned to the desired favorite channel.



**TIP!** To see your list of favorite channels when in the Favorite Channels mode, press display. Scroll to highlight a favorite and press the **Select button** to listen to that channel.

# Using your Xpress<sup>RCi</sup>

## Scanning Channels in a Category

You can scan a category and listen to each channel for 3 seconds before the next channel is automatically tuned. If you want to stay tuned to a channel and stop the scan, just press the **Select button**.

### *To scan a category:*

- 1 Press < or > until the desired category is displayed.
- 2 Scroll down to highlight the next to last item in the category which will be **Scan** and the category name.
- 3 Press the **Select button**. The scan will begin.
- 4 Press the **Select button** to stop the scan and continue to listen to the channel currently being played.

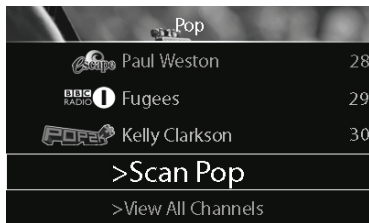

## FM Presets

FM presets make it easy to quickly access stored FM channels and choose a new FM channel from them.

Use FM presets when you use *PowerConnect* to listen to your Xpress<sup>RCi</sup> through your vehicle's FM radio. (Refer to "Option 3: *PowerConnect* Installation Instructions" on page 47 for more information.)

### *To start using a different FM preset:*

- 1 Press and hold **menu** until **FM Channels** is displayed.
- 2 Scroll to highlight the desired FM preset and press the **Select** button.
- 3 The new choice will be confirmed and the Xpress<sup>RCi</sup> will tune to the chosen FM preset.

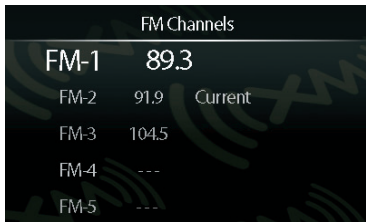

FM Channels		
FM-1	89.3	
FM-2	91.9	Current
FM-3	104.5	
FM-4	---	
FM-5	---	



**IMPORTANT!** You need to ensure that the FM Transmitter in the Xpress<sup>RCi</sup> is turned On, and that your vehicle's FM radio is tuned to the same FM channel.



**TIP!** To configure the list of preset FM channels, you need to find available FM channels in your area. Refer to "Find Available FM Channels in Your Area" on page 89. Next, refer to "Set and Select FM Channels" on page 94 to program your FM presets.

## Skip a Channel

Channels can be removed from the channel list. Once a channel is set to be skipped, it will not appear in any channel list but the channel can still be tuned by using Direct Tune.

You can also add back a channel you had previously designated to be skipped.

### *To skip (or add) channels:*

- 1 Press **menu**.
- 2 Scroll to highlight **Channel Access** and press the **Select button**.
- 3 Scroll to highlight **Channel Skip/Add** and press the **Select button**.
- 4 Each channel preceded by ✓ will appear in the list of channels. To remove a channel from the list, scroll to highlight the channel and press the **Select button**.
- 5 Each channel preceded by ∅ does not appear in the list of channels. To add a channel back to the list, scroll to highlight the channel and press the **Select button** so it is once again preceded by a ✓.
- 6 When finished press **menu** repeatedly to exit.

Channel Access > Channel Skip/Add	
✓ The Blend	25
✓ The Pulse	26
✓ The Bridge	27
✓ Escape	28
✓ BBC Radio 1	29

Channel Access > Channel Skip/Add	
∅ The Blend	25
✓ The Pulse	26
✓ The Bridge	27
✓ Escape	28
✓ BBC Radio 1	29

## Block xL (Explicit Language) Channels

Some channels may contain explicit language. When xL appears in the channel logo, explicit language may be heard on that channel. If you do not want explicit language channels, they can be removed from the channel list.

### *To skip all explicit language channels:*

- 1 Press **menu**.
- 2 Scroll to highlight **Channel Access** and press the **Select button**.
- 3 Scroll to highlight **xL Channels** and press the **Select button**. **xL Channels** will change to yellow.
- 4 Turn the **Control knob** clockwise until **Off** is displayed. Press the **Select button**.
- 5 None of the explicit language channels will appear on the channel list or on the channel skip/add list when **xL Channels** is set to **Off**.

### *To add explicit language channels to the channel list:*

- 1 Press **menu**.
- 2 Scroll to highlight **Channel Access**, and press the **Select button**.
- 3 Scroll to highlight **xL Channels**, and press the **Select button**. **xL Channels** will change to yellow.
- 4 Turn the **Control knob** counter-clockwise until **On** is displayed and

# Using your Xpress<sup>RCi</sup>

press the **Select button**.

- 5** The explicit language channels will now appear on the channel list and on the channel skip/add list.



**IMPORTANT!** To completely block access to explicit channels, contact Listener Care at 1-800-XM-RADIO (1-800-967-2346) or visit <http://www.xmradio.com/parentalcontrols/index.jsp>.

# Special Features

# Special Features

## Pause and Replay

Pause and Replay gives you the opportunity to “hear that again” by temporarily storing and letting you access content played during the last 60 minutes. Pressing << or >>II places the Xpress<sup>RCI</sup> into Replay mode.



**TIP!** This feature applies to the current listening session only. Turning off your Xpress<sup>RCI</sup> removes the temporarily stored content from the radio.

Both display modes (main display screen and split screen) can display previously played tracks. When in Replay mode you can turn the **Control knob** to view and scroll up and down the Replay List. Press the **Select button** to listen to the highlighted selection. The Replay List is displayed from newest to oldest.

### To pause:

- 1 Press >II.
- 2 To resume play, press >II again.

### To listen to the previous track:

- 1 Press << to rewind to a previous track.
- 2 If the current track has been playing for longer than 5 seconds, it is played from its beginning. If the current track has been playing for less than 5 seconds, the previous track is played.

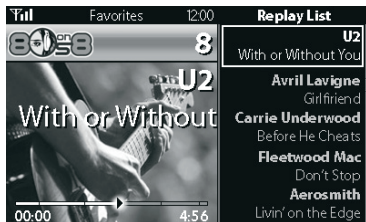



- 3 Press and release < to rewind through a song in increments, or press and hold < to continuously rewind through a song.



**TIP!** Press and hold << for 3 seconds to skip all the way back to the first track.

### *To listen to the next track:*

- 1 Press » to fast-forward to the next track.
- 2 Press and release > to fast-forward through a song in increments or press and hold > to continuously fast-forward through a song.



**TIP!** To return to live broadcast, press and hold » until "Live" appears.



**TIP!** If you press >|| or << in live mode, the Xpress<sup>RCi</sup> will be put in Replay mode.

# Special Features

## TuneSelect

TuneSelect finds your favorite artist and song whenever they're being played on any channel. Xpress<sup>RCi</sup> can track up to a combination of 20 of your favorite artists and songs.

*To save a favorite artist or song:*

- 1 When you hear a favorite artists or songs, press and hold the **Select button** for 2 seconds.
- 2 Scroll to highlight **TuneSelect Artist** to be notified when any song by the artist is played on any channel, or scroll to highlight **TuneSelect Song** to be notified when the song is played on any channel. Press the **Select button**.

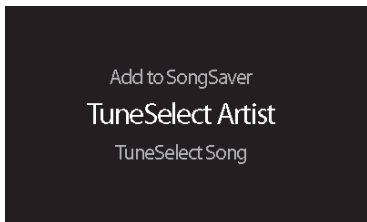

- 3 When an artist or song on your TuneSelect list plays on any channel, you'll hear an alert tone and see a message that informs you about the artist/song and the channel the song is being played on. To switch to that channel, press the **Select button**.

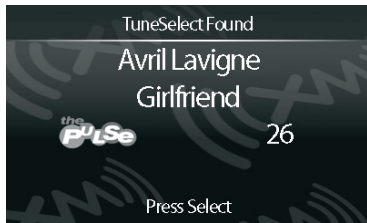

*To remove an artist or song from your TuneSelect list:*

- 1 Press menu.
- 2 Scroll to highlight **Edit Alerts**, and press the **Select** button.
- 3 Press the **Select** button to select **Edit TuneSelect**.

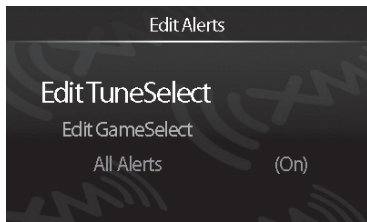

# Special Features

- 4 Scroll to highlight the artist or song you want to remove from your TuneSelect list, and press the **Select button**.
- 5 Scroll to highlight **Do Not Alert** to disable the alert for that artist or song. Press the **Select button**.
- 6 Scroll to highlight **Delete** to remove the artist or song from your list. Press the **Select button**.



**TIP!** You can switch between **Alert on Artist** and **Alert on Song** at the "Edit Alerts > Edit TuneSelect" sub menu.

- To alert on an artist name, scroll to highlight a song title and choose **Alert on Artist**. Press the **Select button**.
- To alert on a song title, scroll to highlight an artist name and choose **Alert on Song**. Press the **Select button**.



**TIP!** You can also TuneSelect artists and songs in both Replay and SongSaver modes.

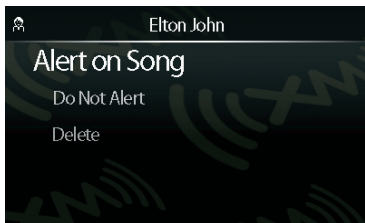

## GameSelect

GameSelect lets you select up to 50 of your favorite sports and/or teams to view their scores and stats at any time. In addition, you can choose to be notified when they play on any channel.

### *To add sports teams to GameSelect:*

- 1 Press **menu**.
- 2 Scroll to highlight **Info Extras** and press the **Select button**.
- 3 Scroll to highlight **Sports** and press the **Select button**.
- 4 Scroll to highlight a favorite sport, and press the **Select button**.
- 5 If your favorite sport is played by teams, scroll to highlight your favorite team, and press the **Select button**.
- 6 A check mark ✓ appears next to sports/teams you have selected.
- 7 To view current scores and stats for the sports and teams on your list, enable the sports ticker by repeatedly pressing **info** until **Sports** is displayed at the bottom left of the display screen.



# Special Features

- When a sport/team on your GameSelect list plays on any channel, you'll hear an alert tone and see a message that informs you about the sport/team and the channel it is playing on. To switch to that channel, press the **Select button**.



**TIP!** You can also set a GameSelect by pressing and holding the **Select button** for 2 seconds while listening to your favorite team or sport.



**NOTE!** If an event occurs on more than one channel simultaneously, a list of channels will be displayed.

## *To remove a sport or team from your GameSelect list:*

- Press **menu**.
- Scroll to highlight **Info Extras** and press the **Select button**.
- Scroll to highlight **Sports** and press the **Select button**.
- Scroll to highlight the sport (or team sport) to be removed and press the **Select button**. The check mark ✓ will be removed.
- If applicable, Scroll to highlight the team to be removed, and press the **Select button**. The check mark ✓ will be removed.

*To disable GameSelect alert:*

- 1** Press **menu**.
- 2** Scroll to highlight **Edit Alerts** and press the **Select button**.
- 3** Scroll to highlight **Edit GameSelect** and press the **Select button**.
- 4** Scroll to highlight the sport or team you no longer want to be alerted about and press the **Select button**.

# Special Features

## Stock Quotes

You can track the price and daily movement for up to 20 of your favorite stocks. The stock ticker can be enabled at the bottom of the screen by repeatedly pressing **info** until **Stocks** is displayed at the bottom left of the display screen.



**NOTE!** Information about most stocks and indices listed on the NYSE, AMEX, or NASDAQ is available. Market information is delayed approximately 25 minutes. Stock data provided by ComStock, Inc.

### *To add a stock:*

- 1 Press **menu**.
- 2 Scroll to highlight **Info Extras** and press the **Select button**.
- 3 Press the **Select button** to select **Stocks**.
- 4 If you already have stocks in your list press the **Select button** to select **Add Stocks**. If not, then skip this step.
- 5 Turn the **Control knob** to select the letters for the stock symbol. Press the **Select button** after each letter.



**TIP!** Xpress<sup>RCi</sup> will help you complete the symbols for more than 9,000 regularly traded stocks.



- 6 When the stock symbol has been correctly entered, you may be prompted to add stock by pressing **Select button**. Or you may need to turn the **Control knob** counter clockwise until **Stock?** appears on display screen. At this time, press the **Select button**.
- 7 At the main display screen, press **info** to see your stock quotes.



**TIP!** To turn on/off the scrolling of stock prices, refer to “Scrolling or Paging Display Appearance” on page 100.

#### *To remove a stock:*

- 1 Press **menu**.
- 2 Scroll to highlight **Info Extras** and press the **Select button**.
- 3 Press the **Select button** to select **Stocks**.
- 4 Scroll to highlight **Erase Stocks** and press the **Select button**.
- 5 Scroll to highlight the stock you want to remove from your list and press the **Select button**.
- 6 Scroll to highlight **Yes** and press the **Select button**.



**TIP!** To remove your entire stock list, scroll to highlight **Erase All Stocks**, press the **Select button**, scroll to highlight **Yes**, and press the **Select button**.

# Special Features

## SongSaver

You can save up to 10 songs in the Xpress<sup>RCI</sup> to listen to them later. Each song stays permanently stored on the radio until it is overwritten or deleted.

- 1 When you hear a song you want to save, press and hold the **Select** button until **Add to SongSaver** is displayed.

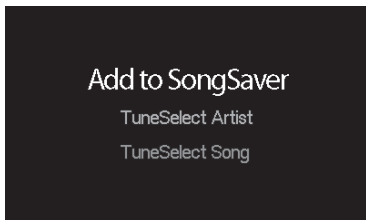

- 2 Press the **Select** button again.



"With or Without You"  
Assigned to Button 5

- 3 Your song is saved to the next available number button location.



**TIP!** When all ten buttons are used up, the next song added to SongSaver overwrites the oldest song saved (i.e., the 11th song is saved to button 1).



**NOTE!** Only songs from live broadcasts can be added to SongSaver.

### *To listen to a saved song:*

- 1 Put the Xpress<sup>RCI</sup> in SongSaver mode. Press **fav** until **SongSaver** appears on the display screen.

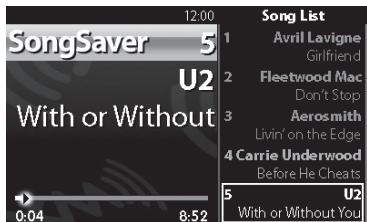

- 2 Press the number button for the song you want to hear.



**TIP!** To see your list of saved songs either rotate the **Control knob** while in main display screen, or go to split screen and view 6 songs at a time. Pressing **◀** or **▶** takes you to the previous and next songs respectively.



**NOTE!** Resetting factory default settings will permanently remove any SongSaver songs.



Where Else Can You Use Your Xpress<sup>RCi</sup>?

# Where Else Can You Use Your Xpress<sup>RCi</sup>?

SIRIUS | XM offers a variety of accessories that allow you to adapt your Xpress<sup>RCi</sup> Radio to your lifestyle and enhance your listening experience. With these accessories, you can effortlessly take your Satellite Radio listening experience from your vehicle to your home or office or on the go – all with a single subscription.

- In the Home, Office, etc. - With a Home Kit, you can play your Xpress<sup>RCi</sup> over an existing home, office, or other stereo system.
- In Other Vehicles - With a Vehicle Kit, you can enjoy your Xpress<sup>RCi</sup> in more than one vehicle.
- In Almost Any Location You Like - With a desktop or portable Sound System you have the freedom to listen to your Xpress<sup>RCi</sup> where and when you want, from your kitchen or den, to the office, to outside on the deck, or at a picnic.

For more information on XM accessories or to purchase an accessory, please visit your local retailer or [www.xmradio.com/accessories](http://www.xmradio.com/accessories).

# Configuring your Xpress<sup>RCi</sup>

# Configuring your Xpress<sup>RCi</sup>

## Radio ID

Your Xpress<sup>RCi</sup> has an alphanumeric ID which uniquely identifies the radio. This ID is used during the activation process.

### *To display the Radio ID:*

- 1 Ensure “Direct” appears at the top of the display screen. If not, press **fav** until it is displayed.
- 2 Use the number buttons (**0-9**) to enter the channel number **0** and wait a moment until the channel is tuned or press the **Select** button.
- 3 The Radio ID is displayed until you tune to another channel.

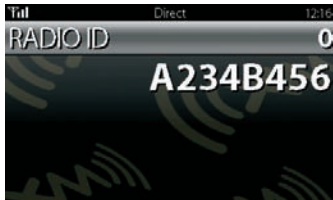



## Find Available FM Channels in Your Area

Before attempting any of the procedures below, you should park your vehicle in a safe location. Do not attempt to set up your FM channels or any onX function while driving.

*PowerConnect* allows you to listen to XM audio through your vehicle's FM radio. You will first need to find an available FM channel, which is a channel that is not being used by an FM radio station in your area. When you tune your FM radio to an available channel, you should only hear static or silence - not talk or music.

Once you have found an available channel, you need to tune your Xpress<sup>RCi</sup>'s built-in transmitter to the same channel to receive XM sound through your vehicle's radio.

We recommend one of the following methods to find an available FM channel:

### 1 Use the SIRIUS | XM FM Channel Finder

Use the SIRIUS | XM FM Channel Finder at [www.xmradio.com/fmchannel](http://www.xmradio.com/fmchannel). Go to the website and enter your zip code. The Channel Finder will suggest a list of available FM channels in your area. For convenience, write down or print out the list.

Tune Xpress<sup>RCi</sup> to a favorite XM channel (or to channel 1, if it's not yet activated). Turn on your vehicle's FM radio. Pick the first FM channel on your Channel Finder list and tune the FM radio to that channel. If you do not hear a local FM station broadcast, then tune the Xpress<sup>RCi</sup> to the same FM channel. (Refer to "Set and Select an

# Configuring your Xpress<sup>RCi</sup>

FM Channel” on page 82.) You should hear the XM channel through your vehicle’s radio. If you are satisfied with the sound quality, you’re done! If this FM channel doesn’t work well for you, work down the list until you find an FM channel that allows you to hear XM clearly.

OR

## 2 Manually tune through your local FM channels

Manually tune through your local FM channels on your vehicle’s FM radio. Turn on your vehicle’s FM radio. Start at 88.1 and use the ‘Manual’ tune function on your vehicle’s FM radio to tune through each FM channel one-by-one (88.1 followed by 88.3 etc.) to locate channels that aren’t being used by a local FM radio station. Write down each FM channel that has only static or silence on it, until you reach 107.9. Once you have created your list of available FM channels, you will need to find the one that provides the best match for your Xpress<sup>RCi</sup>.

Tune Xpress<sup>RCi</sup> to a favorite XM channel (or to channel 1, if it’s not yet activated). Pick the first FM channel on your list and tune the FM radio to that channel. Then tune the Xpress<sup>RCi</sup> to the same FM channel. (Refer to “Set and Select an FM Channel” on page 82.) You should hear the XM channel through your vehicle’s radio. If you are satisfied with the sound quality, you’re done! If this FM channel doesn’t work well for you, work down the list until you find an FM channel that allows you to hear XM clearly.



**NOTE!** You may find an FM channel with static or silence that does not work with Xpress<sup>RCi</sup>. It is possible that some type of inaudible interference is present that prevents reception of the Xpress<sup>RCi</sup> broadcast. Your only options are to use

another FM channel or a different audio connection method.



**TIP!** If you regularly drive from one location to another, such as your daily commute, you may need to use different FM channels along your route for best performance. If this is the case, we recommend saving the best FM channels as presets on your FM radio and Xpress<sup>RCI</sup>. Then you simply select and match the best channel for the area you are in.



**TIP!** It will be much more difficult to find available FM channels in large cities than in most suburban or rural locations. A direct audio connection using the Aux In Cable, Cassette Adapter, or professional installation is your best solution if you drive in or near large metropolitan areas.



**NOTE!** The SIRIUS | XM FM Channel Finder relies on data from the Federal Communications Commission. The data may not reflect the latest stations in your area. In addition, local geography and weather conditions can impact reception, so your results may be different from the list.



**NOTE!** The performance of FM radios are different, based on manufacturer and vehicle style. Some may not work well with the type of FM transmitter used by Xpress<sup>RCI</sup>. This is why we recommend a direct audio connection using the Aux In Cable or Cassette Adapter if they can be used in your vehicle. Professional installation can also resolve almost any performance issue.

## Turn FM Transmitter On/Off

The built-in FM Transmitter in the Xpress<sup>RCI</sup> works when you use *PowerConnect* (or *FMDA*).

*To turn the FM Transmitter On:*

- 1 Press **menu**.
- 2 Press the **Select button** to select **Vehicle Mode**.
- 3 Press the **Select button** to select **FM Transmitter** which will turn yellow.

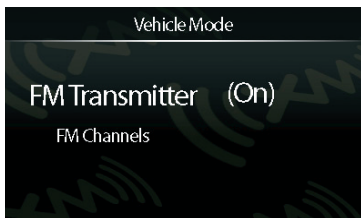

- 4 Turn the **Control knob** clockwise to display **On** and press the **Select button**.



**IMPORTANT!** The Xpress<sup>RCI</sup> is shipped with the FM Transmitter Off, and is programmed with 97.9 as the default FM channel.

*To turn the FM Transmitter Off:*

- 1 Press **menu**.
- 2 Press the **Select button** to select **Vehicle Mode**.
- 3 Press the **Select button** to select **FM Transmitter** which will turn yellow.

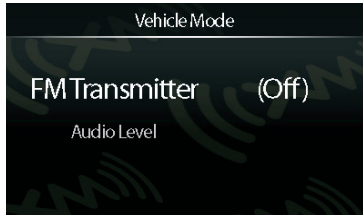

- 4 Turn the **Control knob** counter-clockwise to display **Off** and press the **Select button**.

# Configuring your Xpress<sup>RCi</sup>

## Set and Select FM Channels

The Xpress<sup>RCi</sup> allows you to easily store (i.e., preset) up to 5 different FM channels. At any time, you can select any one of these 5 FM presets to transmit audio from the Xpress<sup>RCi</sup> to your vehicle's FM radio. Having a choice of 5 FM presets also makes it easy to switch to the appropriate FM channel as you travel from one area to another. Each FM preset is stored in its own storage location. You can easily add or edit the FM preset in any one of the 5 storage locations.



**IMPORTANT!** The FM Transmitter has to be turned On before you can set or select an FM channel.



**TIP!** The FM-1 storage location is preset with FM channel 97.9.

### *To set and select an FM preset:*

- 1 Press menu.
- 2 Press the **Select** button to select **Vehicle Mode**.
- 3 Scroll to highlight **FM Channels** and press the **Select** button.
- 4 Scroll to highlight the storage location (FM-1 to FM-5) you want to set and press the **Select** button. You can choose among the following options:

FM Channels	
FM-1	89.3
FM-2	91.9 Current
FM-3	104.5
FM-4	---
FM-5	---

- i. If the chosen storage location is empty (denoted by "---"), or if the

storage location contains the FM preset currently being used (denoted by “Current”), then a list of FM channels is displayed.

- ii. If the chosen storage location has an FM preset that is not currently being used, and you want to edit it, scroll to highlight **Edit Channel** and press the **Select button** to see the list of FM channels.
- iii. If the chosen storage location has an FM preset that is not currently being used, and you want to start using it, press the **Select button** to select **Start Using**. Skip to step 7.



- 5 Scroll to highlight the desired FM channel from the list and press the **Select button**.
- 6 If you are editing the storage location that has the “Current” FM channel, skip to step 7. Otherwise press the **Select button** to select **Start Using**.



**TIP!** You can also preset a new FM preset in a storage location without having to start using it right away. Just press **menu** and exit the screen.

# Configuring your Xpress<sup>RCi</sup>

- 7 The chosen FM channel will be confirmed on the display screen and the Xpress<sup>RCi</sup> will tune to that FM channel.
- 8 Set your vehicle's FM radio to same FM channel.



**IMPORTANT!** You'll first need to find a suitable FM channel that is unused or available in your area.

95.9FM  
Set your vehicle radio to  
the above channel to  
enable audio.

## *To quickly select an FM channel from the preset list:*

- 1 Press and hold **menu** until FM Channels is displayed.
- 2 Scroll to highlight the desired FM preset and press the **Select** button.
- 3 The new choice will be confirmed and the Xpress<sup>RCi</sup> will tune to the chosen FM channel.
- 4 Set your vehicle's FM radio to same FM channel.

FM Channels		
FM-1	89.3	
FM-2	91.9	Current
FM-3	104.5	
FM-4	---	
FM-5	---	



## Set Audio Level

If you are using the Aux In Cable or a Cassette Adapter to play your Xpress<sup>RCi</sup> in your vehicle, you can adjust the audio level to match the volume of other audio sources you may use, such as a CD player, other FM stations, or an MP3 player.

Do not use the audio level as a volume control. Use the volume control on your vehicle stereo instead.



**NOTE!** The audio level adjustment is available only when the FM Transmitter is turned Off.

### *To adjust the audio level:*

- 1 Press **menu**.
- 2 Scroll to highlight **Vehicle Mode** and press the **Select button**.
- 3 Scroll to highlight **Audio Level** and press the **Select button**.
- 4 Turn the **Control knob** to increase or decrease the audio level.
- 5 Press the **Select button**.



**TIP!** If using your Xpress<sup>RCi</sup> in a home dock or sound system (sold separately), press **menu**, scroll to highlight **Audio Level** and press the **Select button**. Use the **Control knob** to adjust to the desired audio level and press the **Select button**.

# Configuring your Xpress<sup>RCi</sup>

## Signal Indicator

For best reception, your Magnetic Mount Antenna should have an unobstructed view of the XM satellites. In large cities, there are terrestrial transmitters (ground repeaters) to help increase the signal coverage.

The Xpress<sup>RCi</sup> can display the strength of the received satellite and terrestrial signals.

### *To display the signal strength:*

- 1 Press **menu**.
- 2 Scroll to highlight **Signal Indicator** and press the **Select button**.
- 3 The Satellite and Terrestrial bars show the strength of the signal being received.
- 4 Reposition the antenna if you are having trouble receiving the signal. Be sure your vehicle is outside with an unobstructed view of the sky.
- 5 Press the **Select button** to exit the signal indicator display screen.

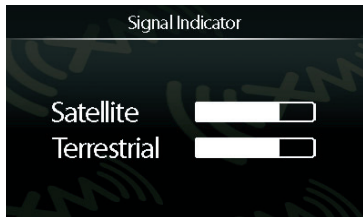

## Display Settings

To change the display's brightness, backlight timer, and auto dimmer:

- 1 Press **menu**.
- 2 Scroll to highlight **Change Display** and press the **Select** button.
- 3 Press the **Select** button to select **Display Setting**.
- 4 To change:

- **Brightness:** Press the **Select** button to select **Brightness** which will turn yellow. Turn the **Control knob** to adjust the brightness. Press the **Select** button when finished.

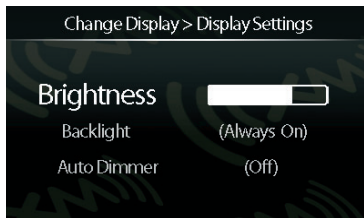

- **Backlight:** Scroll to highlight **Backlight** and press the **Select** button. **Backlight** will turn yellow. Turn the **Control knob** to select the timer setting for the backlight. Press the **Select** button when finished.
- **Auto Dimmer:** When On, auto dimmer adjusts the brightness of the display automatically for daytime and night time. Auto dimmer works when Xpress<sup>RCI</sup> is in the *PowerConnect* Vehicle Dock. Scroll to highlight **Auto Dimmer** and press the **Select** button. **Auto Dimmer** will turn yellow. Turn the **Control knob** clockwise to **On** and press the **Select** button.

# Configuring your Xpress<sup>RCi</sup>

## Scrolling or Paging Display Appearance

Cold weather can negatively affect the visual quality of scrolling text. By default the stock ticker and sports ticker information is set to scroll across the screen. You can change this so the information is displayed as a page.

*To change whether the information is scrolling or paging:*

- 1 Press **menu**.
- 2 Scroll to highlight **Change Display** and press the **Select button**.
- 3 Scroll to highlight **Display Appearance** and press the **Select button**.
  - **Stocks:** Press the **Select button** to select **Stocks** which will turn yellow. Turn the **Control knob** to select either **Scrolling** (the stock ticker will scroll across the screen) or **Paging** (stock information will appear one page at a time).
  - **Sports:** Scroll to highlight **Sports**, and press the **Select button**. Sports will turn yellow. Turn the **Control knob** to select either **Scrolling** (scores will scroll across the screen) or **Paging** (scores will appear one page at a time).
- 4 Press the **Select button** when finished.

## Set Time

The time is automatically set for you from the XM signal.

### *To set your time zone:*

- 1 Press **menu**.
- 2 Scroll to highlight **Set Time** and press the **Select button**.
- 3 Press the **Select button** to select **Set Clock**.
- 4 Press the **Select button** to select **Select Time Zone**.
- 5 Turn the **Control knob** to highlight your time zone and press the **Select button**.

### *To turn on/off Daylight Savings Time:*

- 1 Press **menu**.
- 2 Scroll to highlight **Set Time** and press the **Select button**.
- 3 Press the **Select button** to select **Set Clock**.
- 4 Scroll to highlight **Daylight Savings** and press the **Select button**.  
**Daylight Savings** will turn yellow.
- 5 Turn the **Control knob** to select:
  - Turn clockwise to select **On** if your area participates in Daylight Savings Time.

# Configuring your Xpress<sup>RCi</sup>

- Turn counter-clockwise to select **Off** if your area does not participate in Daylight Savings Time.

**6** Press the **Select button**.

## *To change the format of the time:*

**1** Press **menu**.

**2** Scroll to highlight **Set Time** and press the **Select button**.

**3** Press the **Select button** to select **Set Clock**.

**4** Scroll to highlight **Hour Mode** and press the **Select button**. **Hour Mode** will turn yellow.

**5** Turn the **Control knob** to select:

- Turn counter-clockwise to select **12** to show time using a standard clock.
- Turn clockwise to select **24** to show time using a 24-hour clock.

**6** Press the **Select button**.

## Automatic Power

By default, your Xpress<sup>RCi</sup> turns on automatically when it is plugged in and receiving power. You can change this so you must manually turn the radio on each time.

### *To change the Automatic Power setting:*

- 1 Press **menu**.
- 2 Scroll to highlight **Set Time** and press the **Select button**.
- 3 Scroll to highlight **Automatic Power** and press the **Select button**.  
**Automatic Power** will turn yellow.
- 4 Turn the **Control knob** to select:
  - Turn clockwise to select **Off** to turn your radio on manually after it is plugged in.
  - Turn counter-clockwise to select **On** to have your radio turn on automatically when it is plugged in.
- 5 Press the **Select button**.



**TIP!** When the Xpress<sup>RCi</sup> is in the *PowerConnect Vehicle Dock*, the Remote Control will not be able to turn it on.

# Configuring your Xpress<sup>RCi</sup>

## Delayed Power

Use this feature if you are using the PowerConnect Vehicle Dock and the vehicle's cigarette lighter or power adapter socket is always powered on. Delayed power will turn off the Xpress<sup>RCi</sup> after the selected amount of time to avoid draining the vehicle's battery. By default, delayed power is set to Off but can be set for 60, 90, 120, or 180 minutes.

### *To change the Delayed Power setting:*

- 1 Press menu.
- 2 Scroll to highlight **Set Time** and press the **Select button**.
- 3 Scroll to highlight **Delayed Power** and press the **Select button**. **Delayed Power** will turn yellow.
- 4 Turn the **Control knob** clockwise to choose the amount of time (60, 90, 120, or 180 minutes) that should pass before the radio turns off automatically.
- 5 Press the **Select button**.

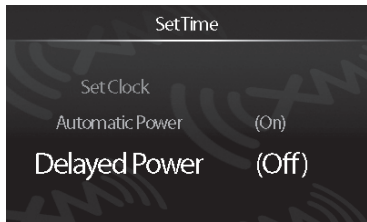



## Sleep Timer

The Sleep Timer option is available with the home dock and sound system (sold separately).

Your Xpress<sup>RCi</sup> has a sleep timer that can automatically shut off the radio after a period of time. By default, the sleep timer is set to Off but can be set for 15, 30, 45 minutes or 1 hour.

### *To change the Sleep Timer:*

- 1 Press **menu**.
- 2 Scroll to highlight **Set Time** and press the **Select** button.
- 3 Scroll to highlight **Sleep Timer** and press the **Select** button. **Sleep Timer** will turn yellow.
- 4 Turn the **Control knob** to choose the amount of time that should pass before the radio automatically turns off (15, 30, 45 minutes, or 1 hour).
- 5 Press the **Select** button.

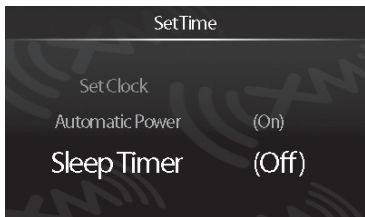

# Configuring your Xpress<sup>RCi</sup>

## Factory Settings

You can clear all of your personal settings, such as Favorite Channels, SongSaver songs, TuneSelect artists/songs, GameSelect sports/teams, Stocks etc., and return the radio to its original out-of-the-box settings.

*To reset the Xpress<sup>RCi</sup> to the factory defaults:*



**NOTE!** Restoring defaults permanently removes all personal settings.

- 1 Press **menu**.
- 2 Scroll to highlight **Factory Settings** and press the **Select button**.
- 3 At the **Restore Defaults** screen, turn the **Control knob** to select:
  - Turn clockwise to select **Yes** to clear your personal settings.
  - Turn counter-clockwise to select **No** to keep your personal settings.
- 4 At the **Are You Sure?** screen, either press the **Select button** to erase the settings, or press **menu** to keep the settings. If you do not press the **Select button** within 5 seconds, the settings will not be reset and the radio will return to the main display screen.
- 5 Press the **Select button**. The radio will restore the settings and you will be returned to the main display screen.

## Demo Mode

Your Xpress<sup>RCi</sup> has a demo mode that starts playing when the radio is not yet activated and it's either not receiving a signal or not connected to the antenna. The demo mode disappears when the antenna is connected properly or when the radio starts receiving a signal. After activation, the demo does not appear under the above conditions.

If desired, you can put the Xpress<sup>RCi</sup> in demo mode after you have activated the radio.

### *To enable or disable Demo Mode:*

- 1** Make sure your Xpress<sup>RCi</sup> is not receiving a signal. Either cover the antenna so it cannot receive a signal or disconnect the antenna.
- 2** Press **menu**.
- 3** Scroll to highlight **Factory Settings** and press the **Select button**.
- 4** Press the **Select button** to select **Demo Mode**. **Demo Mode** will turn yellow.
- 5** Turn the **Control knob** to select:
  - Turn clockwise to **On** to play the demo.
  - Turn counter-clockwise to **Off** when you're ready to turn the demo off.
- 6** Press the **Select button**.



# Troubleshooting

# Troubleshooting

Xpress<sup>RCi</sup> has been designed and built to be trouble-free, but if you experience a problem, try this:

- Check that all connections are firm and secure.
- Make sure the vehicle power socket is clean and free of corrosion.
- Make sure you have connected the Xpress<sup>RCi</sup> as described in this User Guide. Verify that the *PowerConnect* Power Adapter is plugged into the vehicle's cigarette lighter or power adapter socket and that the LED on the *PowerConnect* Power Adapter is lit (on). If not, your vehicle may need to be running to provide power to the socket.

If you see this on the screen:	Try this:
Acquiring Signal	<ul style="list-style-type: none"><li>• Make sure that the vehicle is outdoors with a clear view of the sky.</li><li>• Make sure the Magnetic Mount Antenna is mounted outside of the vehicle.</li><li>• Move the antenna away from any obstructed area. For example, if you are parked in an underground garage, you should receive a signal after leaving the garage.</li></ul>
Check Antenna Connection	<ul style="list-style-type: none"><li>• Make sure that the antenna cable is firmly and securely plugged into the <i>PowerConnect</i> Vehicle Dock. Make sure the cable is not bent or broken.</li><li>• Turn Xpress<sup>RCi</sup> Off, then On, to reset this message.</li><li>• If the message persists, most likely the Magnetic Mount Antenna cable has been damaged. Replace the Magnetic Mount Antenna.</li></ul>

<b>If you see this on the screen:</b>	<b>Try this:</b>
Channel Off Air	<ul style="list-style-type: none"> <li>• The channel you've selected is not currently broadcasting. Tune to another channel.</li> </ul>
Loading	<ul style="list-style-type: none"> <li>• Your Xpress<sup>RCi</sup> is acquiring audio or program information. This message usually goes away in a few seconds.</li> </ul>
Updating	<ul style="list-style-type: none"> <li>• Your Xpress<sup>RCi</sup> is being updated with the latest encryption code. Wait until the update is done.</li> <li>• You may be trying to tune to a channel that is blocked or unavailable. Tune to another channel.</li> </ul>
–	<ul style="list-style-type: none"> <li>• No program information, such as artist name, song title, or channel exists.</li> </ul>
<b>If this happens:</b>	<b>Try this:</b>
You do not receive all the channels to which you subscribed	<ul style="list-style-type: none"> <li>• Ensure that you have activated your service by following the steps in "Activation" on page 54.</li> <li>• Go to <a href="http://www.xmradio.com/refresh">www.xmradio.com/refresh</a> and follow the directions refresh your radio.</li> <li>• Call 1-800-967-2346 for further assistance.</li> </ul>
Audio sounds too soft	<ul style="list-style-type: none"> <li>• Raise the volume of your stereo system or increase the audio level of your Xpress<sup>RCi</sup> until the sound quality improves. Refer to "Set Audio Level" on page 97.</li> </ul>

# Troubleshooting

If this happens:	Try this:
No audio when using the Aux In Cable or Cassette Adapter	<ul style="list-style-type: none"><li>• Check all cables between your Xpress<sup>RCi</sup> and your vehicle's stereo system for a firm and secure connection.</li><li>• Ensure you have selected the proper input source on your vehicle's stereo system.</li><li>• Ensure that the FM Transmitter in the Xpress<sup>RCi</sup> is turned Off, and increase the audio level of the Xpress<sup>RCi</sup>. Refer to "Set Audio Level" on page 97.</li></ul>
Audio fades or has static when listening	<ul style="list-style-type: none"><li>• Check all cables for a firm and secure connection.</li><li>• If you are using <i>PowerConnect</i> (or <i>FMDA</i>) to listen via your vehicle's FM radio, and the problem persists, it most likely is interference from another commercial or broadcast FM station. You will need to find an unused or available FM channel in your area. Refer to "Find Available FM Channels in Your Area" on page 89.</li><li>• If you are using <i>PowerConnect</i>, and you cannot solve the audio problem, try connecting the audio using the Aux In Cable or a Cassette Adapter. (Refer to page 41 and page 44.) If you cannot use those solutions, consider using an FM Direct Adapter. (Refer to page 51.)</li></ul>



<b>If this happens:</b>	<b>Try this:</b>
No audio when using PowerConnect or FMDA	<ul style="list-style-type: none"> <li>• Check that your Xpress<sup>RCi</sup> and your vehicle's FM radio are tuned to the same FM channel.</li> </ul>
No song title or artist name is displayed	<ul style="list-style-type: none"> <li>• The information may not be available or updates may be in progress.</li> </ul>
Traffic and Weather channels sound different from other channels	<ul style="list-style-type: none"> <li>• These channels use a different audio technology than other channels so they often sound different from other channels.</li> </ul>
Xpress <sup>RCi</sup> shuts off unexpectedly	<ul style="list-style-type: none"> <li>• If Sleep Timer is set, the Xpress<sup>RCi</sup> will turn off after the selected length of time in a home dock/sound system. Set Sleep Timer to Off.</li> <li>• If Delayed Power is set, the Xpress<sup>RCi</sup> will turn off after the selected length of time in a dock. Set Delayed Power to Off.</li> </ul>
The demo is playing	<ul style="list-style-type: none"> <li>• Your Magnetic Mount Antenna is not connected or you are not receiving the signal. Check that the antenna is connected properly and is not obstructed.</li> <li>• You can disable Demo Mode. Refer to "Demo Mode" on page 107.</li> </ul>





# Product Specifications

## System

Power Requirements:	9-16 V DC, 500 mA (max)
Operating Temperature:	-20°C to +60°C (-4°F to +140°F)
Audio Output:	1.0 Vrms (max)

## Xpress<sup>RCi</sup> Radio

Dimensions:	115 mm (width) x 63 mm (height) x 17 mm (depth) 4.5 in (width) x 2.5 in (height) x 0.7 in (depth)
Weight:	93 g (3.3 oz)

## Remote Control

Dimensions:	40 mm (width) x 119 mm (height) x 14 mm (depth) 1.6 in (width) x 4.7 in (height) x 0.6 in (depth)
Weight:	40 g (1.4 oz)
Battery:	CR2032 (3 V)

## PowerConnect Vehicle Dock

Dimensions:	102 mm (width) x 59 mm (height) x 31 mm (depth) 4.0 in (width) x 2.3 in (height) x 1.2 in (depth)
Weight:	46 g (1.6 oz)
FM Connector:	2.5 mm female
Audio Connector:	3.5 mm female
Antenna Connector:	SMB male
Power Connector:	4.8 mm female

## PowerConnect Power Adapter

Dimensions:	94 mm (width) x 43 mm (height) x 34 mm (depth) 3.7 in (width) x 1.7 in (height) x 1.3 in (depth)
Input / Output:	9-16 V DC / 5 V DC, 1.5 A
Cable Length:	1.4 m (4 ft 7 in)

**Vehicle Antenna**

Type:

Connector:

Cable Length:

XM Magnetic Mount

SMB female, right angle

7.0 m (23 ft)

**Aux In Cable**

Connectors:

Cable Length:

3.5 mm stereo male to 3.5 mm stereo male

1.2 m (4 ft)

# Patent and Environmental Information

## Patent Information

It is prohibited to, and you agree that you will not, copy, decompile, disassemble, reverse engineer, hack, manipulate, or otherwise access and/or make available any technology incorporated in this product. Furthermore, the AMBE™ voice compression software included in this product is protected by intellectual property rights including patent rights, copyrights, and trade secrets of Digital Voice Systems, Inc. The software is licensed solely for use within this product. The music, talk, news, entertainment, data, and other content on the Services are protected by copyright and other intellectual property laws and all ownership rights remain with the respective content and data service providers. You are prohibited from any export of the content and/or data (or derivative thereof) except in compliance with applicable export laws, rules and regulations. The user of this or any other software contained in a SIRIUS | XM radio is explicitly prohibited from attempting to copy, decompile, reverse engineer, hack, manipulate or disassemble the object code, or in any other way convert the object code into human-readable form.

## Environmental Information

Follow local guidelines for waste disposal when discarding packaging and electronic appliances.

Your radio is packaged with cardboard, polyethylene, etc., and does not contain any unnecessary materials.

# FCC Statement

The user is cautioned that changes or modifications not expressly approved by SIRIUS XM Radio Inc. can void the user's authority to operate this device.

This device complies with Part 15 of the FCC Rules. Operation is subject to the following two conditions:

1. This device may not cause harmful interference.
2. This device must accept any interference received, including interference that may cause undesired operation.

This equipment has been tested and found to comply with the limits for a Class B digital device, pursuant to Part 15 of the FCC Rules. These limits are designed to provide reasonable protection against harmful interference in a residential installation.

This equipment generates, uses, and can radiate radio frequency energy and, if not installed and used in accordance with the installation instructions, may cause harmful interference to radio communications. However, there is no guarantee that interference will not occur in a particular installation. If this equipment does cause harmful interference to radio or television reception, which can be determined by turning the equipment off and on, the user is encouraged to try to correct the interference by one or more of the following measures:

- Reorient or relocate the receiving antenna of the affected receiver.
- Increase the separation between the SIRIUS | XM equipment and the affected receiver.
- Connect the SIRIUS | XM equipment into an outlet on a circuit different from that to which the affected receiver is connected.
- Consult the dealer or an experienced radio/TV technician for help.

**WARNING!** The FCC and FAA have not certified this Satellite Radio Receiver for use in any aircraft (neither portable nor permanent installation). Therefore, SIRIUS XM Radio Inc. cannot support this type of application or installation.

# Copyrights and Trademarks

©2009 SIRIUS XM Radio Inc. "SIRIUS", "XM" and all related marks and logos are trademarks of SIRIUS XM Radio Inc. and its subsidiaries. "BBC" and "Radio One" are trademarks of the British Broadcasting Corporation and are used under license. BBC logo © BBC 1996. Radio 1 logo © BBC 2001. Cosmopolitan™ is a registered trademark of Hearst Communications, Inc. Elvis Radio logo © EPE Reg. U.S. Pat & TM off. IndyCar (and Design) are registered trademarks of Brickyard Trademarks, Inc., used with permission. Major League Baseball trademarks and copyrights are used with permission of Major League Baseball Properties, Inc. Visit the official website at MLB.com. Games subject to availability and change and may not include all spring training games. All rights reserved. NASCAR™ is a registered trademark of the National Association for Stock Car Auto Racing, Inc. The NBA identifications are the intellectual property of NBA Properties, Inc. and the respective NBA member teams. © 2009 NBA Properties, Inc. © 2009 NFL Properties LLC. All NFL-related trademarks are trademarks of the National Football League. NHL and the NHL Shield are registered trademarks of the National Hockey League. © NHL 2009. All NHL logos and marks and NHL team logos and marks depicted herein are the property of the NHL and the respective teams and may not be reproduced without the prior written consent of NHL Enterprises, L.P. The Home Ice® channel is a registered trademark of XM Satellite Radio Inc. The Swinger Golfer logo is a registered trademark of PGA TOUR, Inc. Visit [xmradio.com/xmlineup](http://xmradio.com/xmlineup) for updates. All programming/channel lineup/XM service subject to change or preemption. All other marks and logos are the property of their respective owners. All rights reserved. Hardware, subscription and activation fee required. Other fees and taxes may apply. Month-to-month subscriptions must be activated via telephone. Hardware and subscription sold separately. Subscription governed by XM Customer Agreement, which can be found at [xmradio.com/serviceterms](http://xmradio.com/serviceterms). Prices and programming are subject to change. **XM Radio U.S. service only available in the 48 contiguous United States and the District of Columbia.**



# Owners Record

## Owner's Record

The radio model number is located below and the XM Radio ID is located on the label on the back of the Xpress<sup>RCi</sup>.

Record the XM Radio ID in the space provided below. Refer to these numbers whenever you call your dealer regarding this product.

Radio Model Number: XDRC2

XM Radio ID: \_\_\_\_\_





xmradio.com

SIRIUS XM Radio Inc.  
1221 Avenue of the Americas  
New York, NY 10020

1.800.967.2346

© 2009 SIRIUS XM Radio Inc.

XDRC2UG 092809a

## Free Manuals Download Website

<http://myh66.com>

<http://usermanuals.us>

<http://www.somanuals.com>

<http://www.4manuals.cc>

<http://www.manual-lib.com>

<http://www.404manual.com>

<http://www.luxmanual.com>

<http://aubethermostatmanual.com>

Golf course search by state

<http://golfingnear.com>

Email search by domain

<http://emailbydomain.com>

Auto manuals search

<http://auto.somanuals.com>

TV manuals search

<http://tv.somanuals.com>