



# Xpress™



## vehicle guide

### XMC-10A



**Important:** This manual contains important safety and operating information. Please read, understand, and follow the instructions in this manual. Failure to do so could result in personal injury, death, and/or damage to your Xpress accessories, and/or to your vehicle or property.

## ***Table of Contents***

Congratulations .....	3
FCC Information .....	4
Cautions and Warnings .....	5
Contents XMC10A .....	6
Accessory Kit .....	7
Installation/Wiring Precautions .....	8
Setting Up and Installing Your Kit .....	9
Cabling Interconnections .....	9
Installing the Cradle Mount Base Assembly .....	9
Interconnect Diagram .....	10
Using Other Manufacturer's Mounts .....	15
Installing the Xpress XM® Into the Cradle .....	15
Connection Options .....	17
Installation Guidelines .....	20
Warranty .....	24

## ***Congratulations***

Thank you for purchasing the Audiovox Xpress XM® Satellite Radio 2nd Vehicle Kit. You are one step closer to experiencing the latest innovation in XM Satellite Radio. XM Satellite Radio will revolutionize your vehicle or in-home entertainment.

XM is America's number one satellite radio service with more than 7 million subscribers. Broadcasting live daily from studios in Washington, DC, New York City, the Country Music Hall of Fame in Nashville, Toronto and Montreal, XM's 2006 lineup includes more than 170 digital channels of choice from coast to coast: the most commercial-free music channels, sports, talk, comedy, children's and entertainment programming; and the most advanced traffic and weather information.

XM the leader in satellite-delivered entertainment and data services for the automobile market through partnerships with General Motors, Honda, Toyota, Hyundai, Nissan, Subaru, Suzuki and Porsche, is available in more than 140 different vehicle models for 2006. XM's industry-leading products are available at consumer electronics retailers nationwide. For more information about XM hardware, programming and partnerships, please visit <http://www.xmradio.com>.

Required subscription for service sold separately. Premium Channels available at additional monthly costs. Installation costs and other fees and taxes may apply, including a one-time activation fee. All fees and programming subject to change. College sports games subject to availability. Subscriptions subject to Customer Agreement included with the XM Welcome Kit and available at <http://www.xmradio.com>. Only available in the 48 contiguous United States

©2006 XM® Satellite Radio Inc. XM is a trademark of XM Satellite Radio. All rights reserved. All other trademarks are the property of their respective owners.

## FCC Information

Please note that the power cable that has been supplied with your device is supplied with permanently attached ferrite beads at each end. It is the responsibility of the user to use the cable with the ferrite beads.

The user is cautioned that changes or modifications not expressly approved by XM® Satellite Radio Inc. can void the user's authority to operate this device.

This device complies with Part 15 of the FCC Rules. Operation is subject to the following two conditions: (1) This device may not cause harmful interference, and (2) this device must accept any interference received, including interference that may cause undesired operation.

This equipment has been tested and found to comply with the limits for a Class B digital device, pursuant to Part 15 of the FCC Rules. These limits are designed to provide reasonable protection against harmful interference in a residential installation.

This equipment generates, uses, and can radiate radio frequency energy and, if not installed and used in accordance with the installation instructions, may cause harmful interference to radio communications. However, there is no guarantee that interference will not occur in a particular installation. If this equipment does cause harmful interference to radio or television reception, which can be determined by turning the equipment off and on, the user is encouraged to try to correct the interference by one or more of the following measures:

- Reorient or relocate the antenna of the affected receiver.
- Increase the separation between the XM equipment and the affected receiver.
- Connect the XM equipment into an outlet on a circuit different from that to which the affected receiver is connected.
- Consult the dealer or an experienced radio/TV technician for help.

**Warning:** The FCC and FAA have not certified XM Satellite Radio Receivers for use in any aircraft (neither portable nor permanent installation). Therefore, XM Satellite Radio, Inc. cannot support this type of application or installation.

## ***Cautions and Warnings***

1. Do not install the XMC10A vehicle cradle in a position that hinders your view through the windshield, or obstructs viewing of the dashboard indicators and displays.
2. Do not install the unit where it may obstruct the operation or deployment of safety devices, such as airbags, etc.
3. Do not allow operation of the unit to detract from safe driving practices; remember that you are responsible as the vehicle operator to adhere to all safe driving and traffic regulations.
4. By adhering to these warnings and safety considerations, serious accidents and/or personal injury can be avoided.

## Contents XMC10A

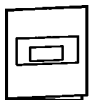

**Install Manual**

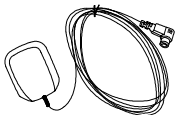

**Antenna 1 pc.**

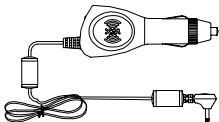

**12 Volt-to-5 Volt DC Power Adapter 1 pc.**

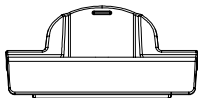

**Cradle XMC10A 1 pc.**

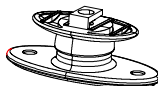

**Swivel Bracket 1 pc.**



**Cassette Adapter 1pc.**

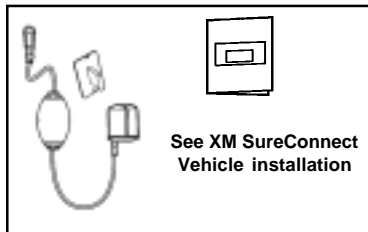

**See XM SureConnect Vehicle installation**

**XM SureConnect Kit 1 pc.**

## Contents XMC10A (Cont)

### ACCESSORY KIT

Alcohol Cleaning Pad,  
Surface Cleaning Pad,  
Instruction Sheet,  
Antenna Cable Exit Plug

---

OPTIONAL(sold separately)



**Audio Cable  
(P/N SAT-RCA)**

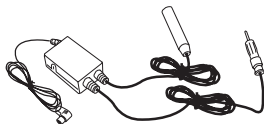

**FM Direct Adapter  
(P/N XMFM-1)**

## ***Installation/Wiring Precautions***

1. To prevent a short-circuit, be sure to turn off the ignition and remove the negative (-) battery cable prior to installation. Connect power wires last.
2. Do not install the unit in locations exposed to direct sunlight or, in areas subject to extreme temperatures.
3. Incorrect installation may cause damage to the system. Mount the unit firmly in place, using the supplied hardware.
4. Be careful not to damage the vehicle wiring.
5. Be sure to use the supplied screws and washers.
6. Be careful not to snag any wires when tightening screws.
7. Use only the 12 Volt-to-5 Volt DC Power Adapter supplied. Use of an alternative power adapter may damage the Xpress XM receiver and/or the XMC10A cradle.

***CAUTION:*** *You could drain the vehicle battery if the DC power adapter remains plugged in after the ignition is turned off. Unplug the adapter to prevent this possibility.*



## Setting Up and Installing Your Kit

**NOTE:** *The XM signal can be received and processed virtually anywhere as long as there are no obvious satellite signal obstructions such as nearby buildings, high terrain, parking garages or tunnels.*

### 1. **Cabling Interconnections**

You can begin to enjoy XM Satellite Radio as soon as the Xpress XM Receiver and Vehicle Kit installation are complete. Set up your Audiovox Xpress XM System using the following installation instructions, or enlist the help of a professional installer:

### 2. **Installing the Cradle Mount Base Assembly**

- a. Interconnect all of the components as shown on the adjacent page to verify that the system operates normally.
- b. Locate a firm, reasonably flat surface within your car to permit optimum viewing and line-of-sight access by the supplied remote control unit.

## Interconnect Diagram

### NOTE:

1. IF THE XMC10A IS INSTALLED USING THE OPTIONAL XMFM-1 FM DIRECT ADAPTER, DO NOT CONNECT AN AUDIO CABLE TO THE AUDIO OUT CONNECTOR OF THE CRADLE.

2. THE FM MODULATOR OPTION MUST BE SET TO "FM ON" IN THE XPRESS XM USER MENU. (REFER TO THE USER GUIDE)

AUX AUDIO INPUT TO AUDIO OUTPUT OF EXTERNAL PLAYBACK DEVICE. THIS PERMITS AUDIO FROM AN EXTERNAL DEVICE SUCH AS A PORTABLE CD PLAYER OR MP3 PLAYER TO BE PLAYED THROUGH THE XPRESS XM FM MODULATOR.

**XMC10A CRADLE  
(LEFT SIDE VIEW)**

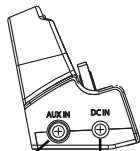

+12V to +5V  
DC POWER  
ADAPTER

OR

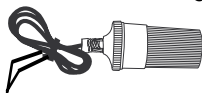

TO VEHICLE  
+12 VDC POWER  
RECEPTACLE

CLA FEMALE SOCKET WIRES  
TO VEHICLE +12 VDC POWER  
RECEPTACLE (OPTION WITH  
XMFM1 KIT)

## Interconnect Diagram (Cont)

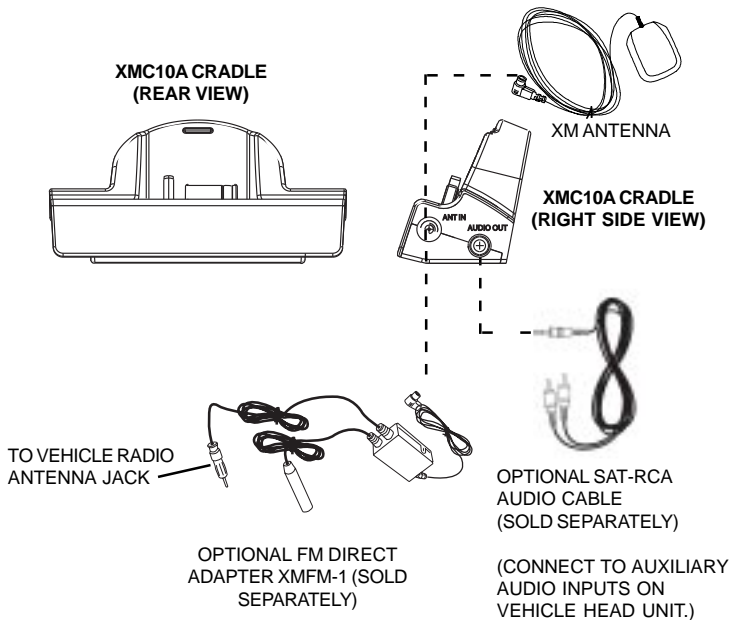

**CAUTION:** *Do not install the swivel bracket on a leather or fabric surface, or in a position that could impair your vision, block air bag(s) or obstruct vehicle dashboard controls and/or radio CD/cassette operational displays.*

**NOTE:** *The adhesive backing on the bracket will not permit easy repositioning once it has been mated to the surface; use extreme care and planning when selecting the mounting location. If the bracket is to be screwed to the surface, make sure the area in back of the mounting surface is clear of wires or other items to prevent unintentional damage.*

- c. Using the alcohol swab supplied with your kit, clean the mounting surface and thoroughly wipe the area dry with a clean lint-free cloth.
- d. If the outside air temperature is cold, it may be beneficial to warm the adhesive backing on the bracket using a portable hair dryer, or by holding the backing surface in front of a vehicle heater vent.

- e. Remove the plastic liner from the adhesive backing on the bracket, and fix the base in position on the surface; make sure the mounting pad is accurately positioned on the first try, since repositioning may be difficult, if not impossible.
- f. If the bracket is to be screwed in place, do not remove the plastic liner from the adhesive backing. Use appropriate sheet metal or machine screws for this purpose.
- g. To mount the XMC10A cradle atop the swivel bracket, line up the slot at the rear of the cradle with the bracket retainer tab, and slide the cradle down so that the slot and tab mesh together in a locked position.

**NOTE:** *Allow a 72-hour period for the adhesive backing to cure completely.*

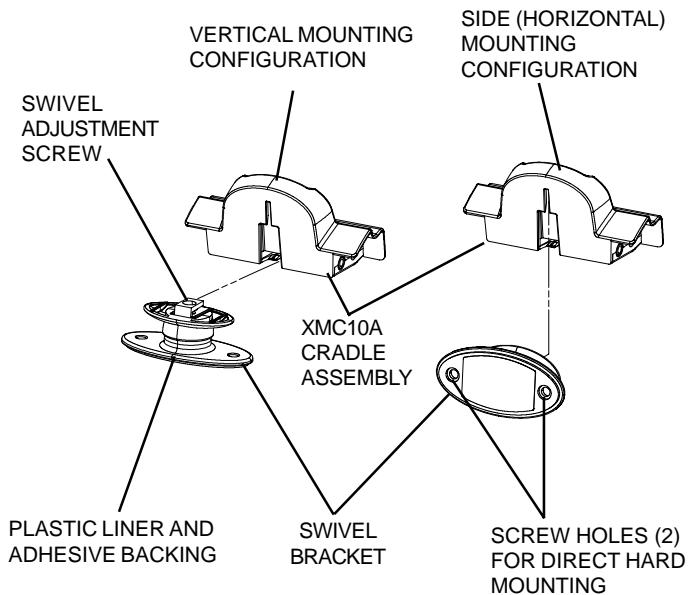

### **3. *Using Other Manufacturer's Mounts***

The XMC10A Cradle can also be installed using other manufacturer's mounts; the mounting plate provisions on the rear and bottom of the cradle provide you with two mounting options within the vehicle using various vehicle-specific aftermarket brackets.

### **4. *Installing the Xpress XM Receiver into the Cradle***

Install the Receiver as follows:

- a. After making sure the connectors and guide pin hole are properly lined up, gently lower the Xpress XM Receiver into the cradle and press down on the Xpress XM Receiver to mate the connectors together. The raised detent on the cradle will enter the notch on the rear of the Receiver, indicating the Xpress XM is properly seated.
- b. The Xpress XM Receiver should now be secured in the cradle

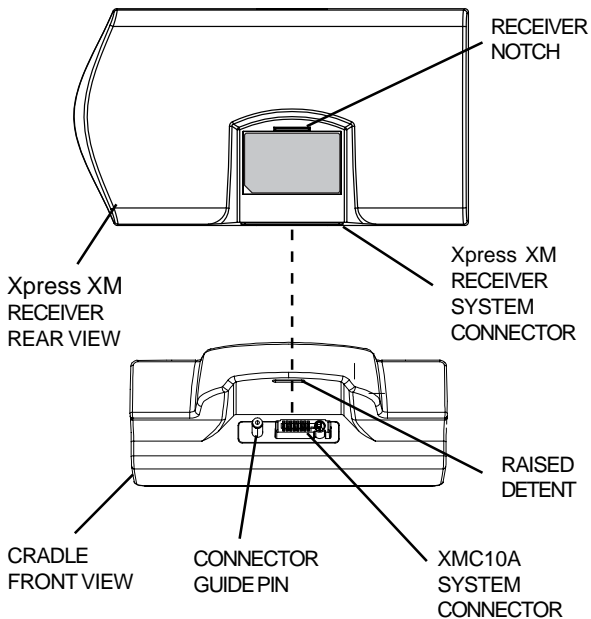



## 5. Connection Options

The Xpress Receiver and Cradle provide an audio output signal in three ways:

- a. **FM Modulator** - When using the XMC10A cradle with the FM modulator option, the XM audio signal can be received through your vehicle's radio on selectable FM frequencies using the menu option included in your Xpress Receiver. (Refer to the User Guide.) The XM audio signal can then be played through your vehicle's radio when that radio is tuned to one of the available frequencies.

**NOTE:** To minimize radiated interference from the XM equipment (antenna and receiver), it will be necessary to incorporate the XM SureConnect Vehicle Installation instructions provided in the XMC10A.

- b. **FM Direct Wiring** - If the FM modulator does not provide satisfactory performance in your vehicle, use the optional FM Direct Adapter, Part # XMFM-1, which provides a hard wired FM output.
- c. **Low-Level Audio Output** - For vehicles equipped with radio head units with auxiliary audio inputs, the audio signal can be routed through an optional audio cable (Part No. SAT-RCA) and applied to the auxiliary inputs of a radio or entertainment system. In this case, it is best to turn the Xpress Receiver FM modulator option off to avoid interference.



### Xpress Cassette Adapter Installation.

Installation is simple.

- 1.) Plug the end jack (1) into the XM Xpress Car Cradle's audio output (2).
- 2.) Insert the cassette adapter (3) in the vehicle's in-dash cassette slot (4).

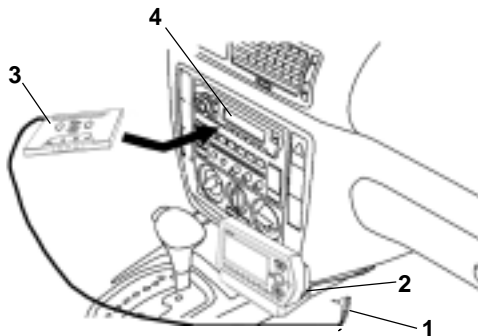

## 6. Installation Guidelines

### Step 1.

First, determine the proper location for your XM satellite radio antenna based on the following criteria for your specific vehicle:

- a. You must locate the satellite radio antenna on the top of the roof either in front of the rear window (option 1) or behind the windshield (option 2). The satellite radio antenna will perform best if magnetically attached to a steel surface with an unobstructed view of the open sky and minimum of 3 to 6 inches of metal surrounding the antenna.

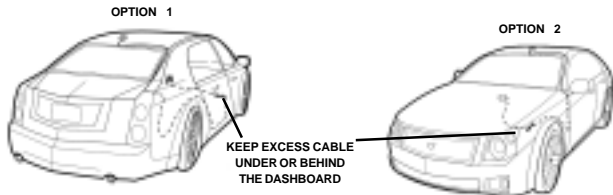

- b. When routing the antenna cable along the windshield or rear window, tuck the antenna cable under the window seal to maintain a professional looking installation and to avoid loose wires on the exterior of the vehicle which are susceptible to damage. Follow the interior cable routing diagram depicted by dashed lines in the illustration above where possible.

- c. Avoid kinking, crimping, twisting or chafing the cable. Use pre-existing wire channels when possible.
  
- d. For option 1 and rear mounting locations, route the cable into the trunk as shown in the previous illustration. Always cross the weather seal at the lowest part of the trunk to reduce water leaks. From the trunk, route the cable into the passenger compartment through available wire channels and then along the floor under the door jam trim or under the carpet to the front of the passenger compartment. Do not leave the cable loose in the passenger compartment where it is likely to be damaged.
  
- e. For option 2 and front mounting locations, route the cable along the door jam and into the vehicle as shown. Route the cable across the weather seal near the bottom of the door to reduce water leaks.

**Step 2.**

Once you have plugged the power and antenna jacks into the vehicle cradle, secure the cables with tape or wire ties to allow for a clean appearance. For example, secure the excess cable up under your dash board, between the seat and the console, or on the floor under a seat or floor mat. This will help to prevent the excess cable from interfering with the everyday use of your vehicle, improve the appearance of the installation, and avoid any undesirable accidental damage to the cables that might result in loss of power or satellite signal.

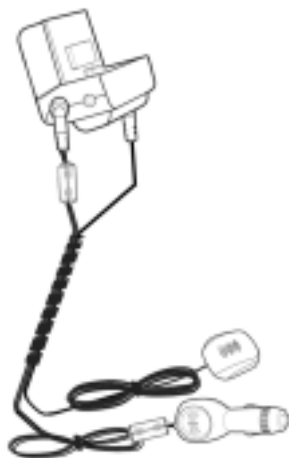

Be sure to choose a location carefully by taking notice of how doors and trunks open and close, as well as how seats move when they are adjusted so you can be certain there is ample clearance provided for the cables.

# NOTES

**AUDIOVOX®****12 MONTH LIMITED WARRANTY**

AUDIOVOX ELECTRONICS CORPORATION (the Company) warrants to the original retail purchaser of this product that should this product or any part thereof, under normal use and conditions, be proven defective in material or workmanship within 12 months from the date of original purchase, such defect(s) will be repaired or replaced with new or reconditioned product (at the Company's option) without charge for parts and repair labor.

To obtain repair or replacement within the terms of this Warranty, the product is to be delivered with proof of warranty coverage (e.g. dated bill of sale), specification of defect(s), transportation prepaid, to an approved warranty station or the Company at the address shown below.

This Warranty does not extend to the elimination of externally generated static or noise, to costs incurred for installation, removal or reinstallation of the product, damage to speakers, accessories, or vehicle and home electrical systems, malfunction of satellite transmissions, repeater signal or receiver unit.

This Warranty does not apply to any product or part thereof which, in the opinion of the Company, has suffered or been damaged through alteration, improper installation, mishandling, misuse, neglect, accident, or by removal or defacement of the factory serial number/bar code label(s).



THE EXTENT OF THE COMPANY'S LIABILITY UNDER THIS WARRANTY IS LIMITED TO THE REPAIR OR REPLACEMENT PROVIDED ABOVE AND, IN NO EVENT, SHALL THE COMPANY'S LIABILITY EXCEED THE PURCHASE PRICE PAID BY PURCHASER FOR THE PRODUCT.

This Warranty is in lieu of all other express warranties or liabilities. ANY IMPLIED WARRANTIES, INCLUDING ANY IMPLIED WARRANTY OF MERCHANTABILITY, SHALL BE LIMITED TO THE DURATION OF THIS WRITTEN WARRANTY. ANY ACTION FOR BREACH OF ANY WARRANTY HEREUNDER INCLUDING ANY IMPLIED WARRANTY OF MERCHANTABILITY MUST BE BROUGHT WITHIN A PERIOD OF 48 MONTHS FROM DATE OF ORIGINAL PURCHASE. IN NO CASE SHALL THE COMPANY BE LIABLE FOR ANY CONSEQUENTIAL OR INCIDENTAL DAMAGES FOR BREACH OF THIS OR ANY OTHER WARRANTY, EXPRESS OR IMPLIED, WHATSOEVER. No person or representative is authorized to assume for the Company any liability other than expressed herein in connection with the sale of this product.

Some states do not allow limitations on how long an implied warranty lasts or the exclusion or limitation of incidental or consequential damage so the above limitations or exclusions may not apply to you. This Warranty gives you specific legal rights and you may also have other rights which vary from state to state.

**U.S.A. :** AUDIOVOX ELECTRONICS CORPORATION, 150 MARCUS BLVD.,  
HAUPPAUGE, NEW YORK 11788 (1-800-645-4994)

128-7351



Audiovox Electronics Corporation  
150 Marcus Blvd.  
Hauppauge, New York 11788  
U.S.A.  
1 800 645 4994

[www.audiovox.com](http://www.audiovox.com)

♻️ Printed on Recycled Paper  
©2006 Audiovox Electronics Corporation. All rights reserved.  
XM name and related logos are trademarks of XM Satellite Radio Inc.

**XMC-10A**

128-7472H

## Free Manuals Download Website

<http://myh66.com>

<http://usermanuals.us>

<http://www.somanuals.com>

<http://www.4manuals.cc>

<http://www.manual-lib.com>

<http://www.404manual.com>

<http://www.luxmanual.com>

<http://aubethermostatmanual.com>

Golf course search by state

<http://golfingnear.com>

Email search by domain

<http://emailbydomain.com>

Auto manuals search

<http://auto.somanuals.com>

TV manuals search

<http://tv.somanuals.com>