

RAMPAGE[™]
BY AUDIOVOX

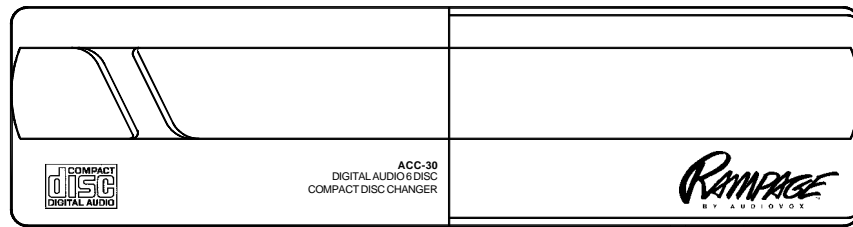

**MODEL ACC-30
6-DISC CD CHANGER**



INSTALLATION MANUAL

PACKING LIST

MAIN UNIT

Changer

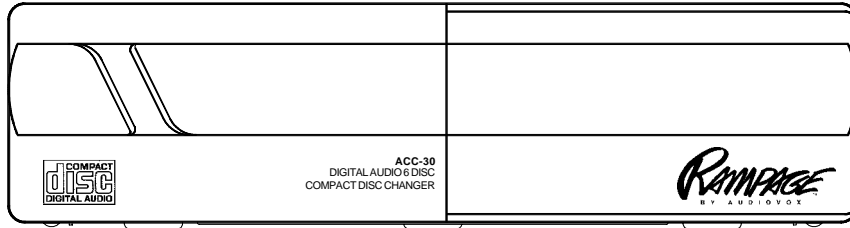

INSTALLATION PARTS

Mounting Bracket

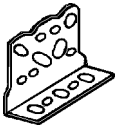

2 pcs.

Hex Head Bolt with Washer Base
(M5 x 12)



4 pcs.

Phillips Head
Screw



4 pcs.

Mounting Angle Adjustment Tool



1 pc.

Screw Hole Cover Labels

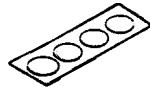

1 pc.

5 Meter Din Cable

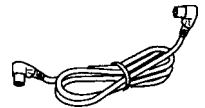

1 pc.

ACCESSORIES

CD Magazine

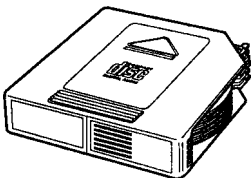

1 pc.

Index seal sheet

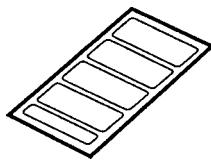

1 pc.

Installation Manual

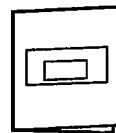

1 pc.

Owner's guide

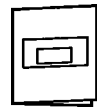

1 pc.

BEFORE INSTALLING THE UNIT

Transport Lock Screws

The mechanism in the CD changer is "locked" into place during shipment by the 4 transport screws. Be sure to remove the screws prior to installation. Retain these screws for future use when transporting the unit for service/maintenance.

● Caution ●

After removing the transport lock screws, place the supplied seals over the screw holes. These seals are used to keep dust out of the unit, which could cause a malfunction.

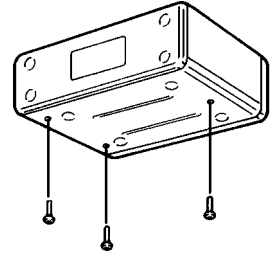

Installation and Wiring Precautions

- 1 To prevent a short-circuit,
 - Be sure to turn off the ignition and remove the negative (-) battery cable, prior to installation.
 - Connect power wires last.

Note

If the changer is to be installed in a car that is equipped with an on-board drive or navigation computer, do not disconnect the battery cable. If the cable is disconnected, the computer memory may be lost. Under these conditions, use extra caution during installation, not to cause a short circuit.

- 2 Do not install the unit in the following locations.
 - Locations exposed to direct sunlight.
 - Where hot air is discharged from the car heater.
 - In areas subject to extreme temperatures.
- 3 Incorrect installation can cause the sound to "skip" when playing a disc. Mount the unit firmly in place, using the supplied brackets and screws.
- 4 Be careful not to damage the car wiring.
- 5
 - Be sure to use the supplied screws.
 - Be careful not to snag any wires when tightening screws.
 - Do not use any of the screws that are part of the brake or steering system, to install the unit.
- 6
 - This unit cannot be installed on its side, end, or upside down. Installation in such positions will cause malfunctioning of the mechanism.

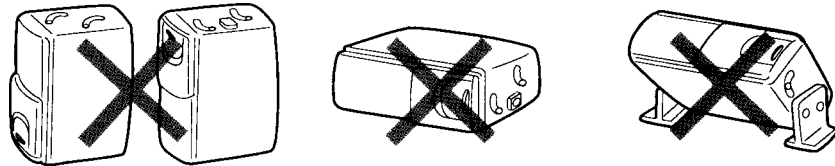
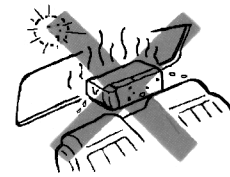

INSTALLATION

The unit can be installed horizontally, vertically or at a 45° angle. The position of the built-in anti-vibration springs (left and right side), must correspond to the mounting position chosen. If the springs are not set correctly for the type of installation chosen, the anti-vibration compensation will not be effective and vibration may cause the disc to skip.

HORIZONTAL INSTALLATION

Set the anti-vibration springs to position "H".

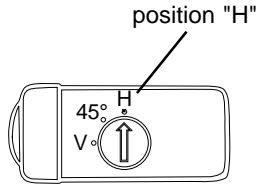

VERTICAL INSTALLATION

Set the anti-vibration springs to position "V".

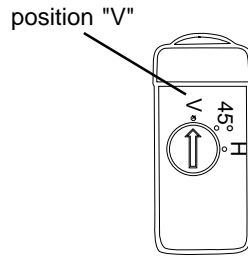

45° ANGLE INSTALLATION

Set the anti-vibration springs to position "45°".

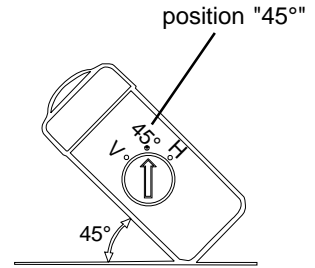

PROCEDURE FOR HORIZONTAL INSTALLATION

- 1 Attach a mounting bracket to each side of the unit, using the 4 hex head bolts with washer base.

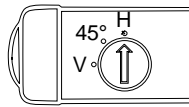

NOTE: Make sure anti-vibration springs are set to position "H".

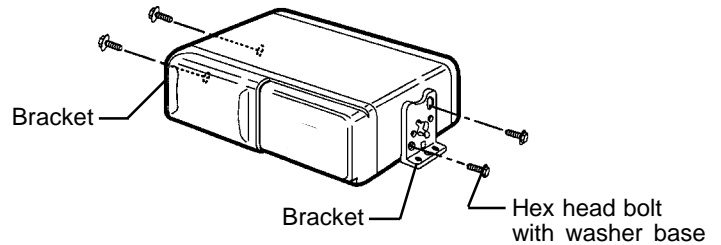

- 2 Determine the mounting location, and drill four mounting holes.

NOTE: If mounting surface is carpeted, use caution when drilling holes to prevent drill bit from catching on carpet. Cut holes in carpet before drilling into sub-surface.

Never mount the unit near the fuel tank.

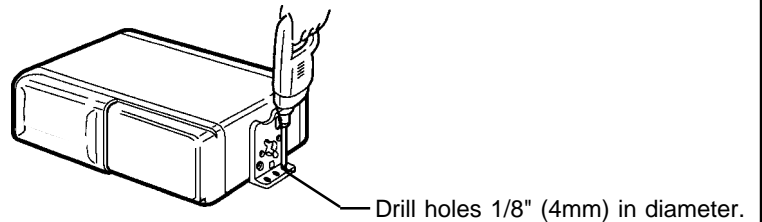

- 3 Secure the unit in place, using four self-tapping Phillips head screws. Use RTV (silicone sealer) on screw threads or around the holes to prevent moisture intrusion.

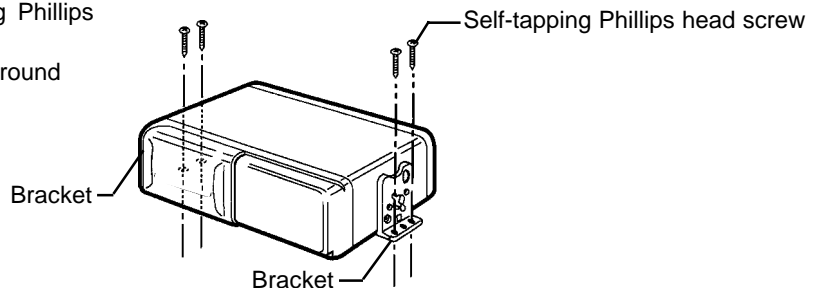

PROCEDURE FOR VERTICAL INSTALLATION

Note

If the anti-vibration spring position has been changed and verified for vertical mounting (as shown on page 3), start with step 2.

- 1** Set the anti-vibration springs to position "V".

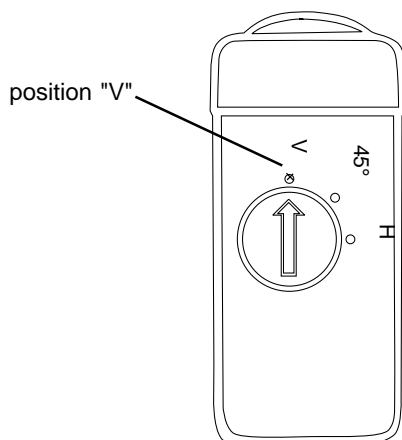

- 2** Attach a mounting bracket to each side of the unit, using the hex head bolts with washer base.

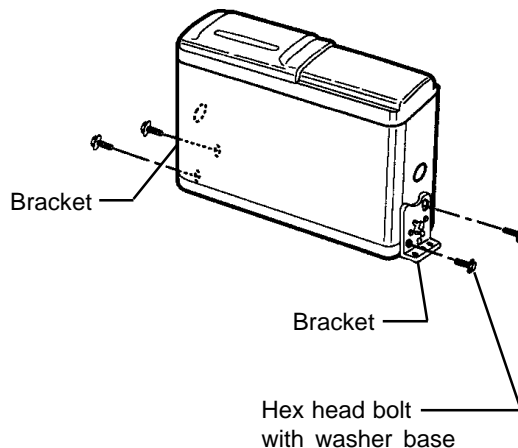

- 3** Determine the mounting location, and drill four mounting holes.

NOTE: If mounting surface is carpeted, use caution when drilling holes to prevent drill bit from catching on carpet. Cut holes in carpet before drilling into sub-surface.

Never mount the unit near the fuel tank.

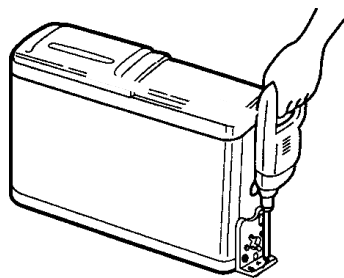

Drill holes 1/8" (4mm) in diameter

- 4** Mount the unit in place, using four self-tapping Phillips head screws.

Use RTV (silicone sealer) on screw threads or around the holes to prevent moisture intrusion.

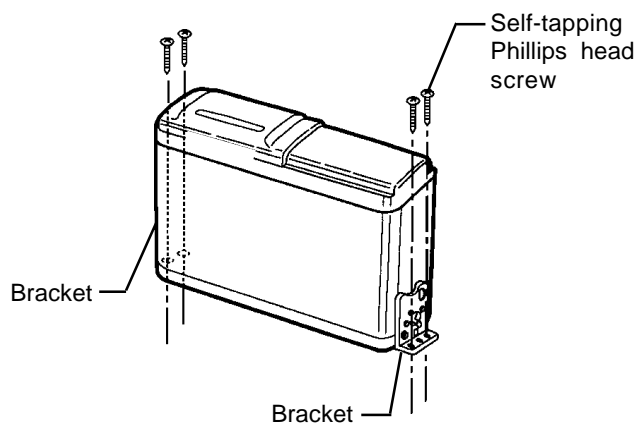

PROCEDURE FOR 45° ANGLE INSTALLATION

Note
If the anti-vibration spring position has been changed and verified for 45° angle mounting (as shown on page 3), start with step 2.

1 Set the anti-vibration springs to position "45°".

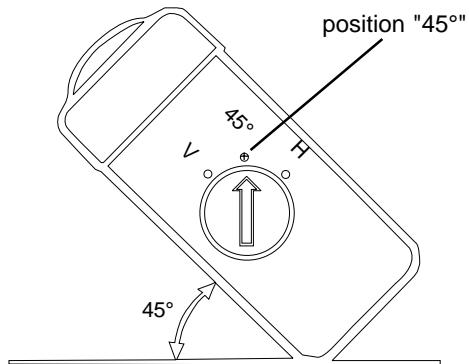

2 Attach a mounting bracket to each side of the unit, using the 4 hex head bolts with washer base.

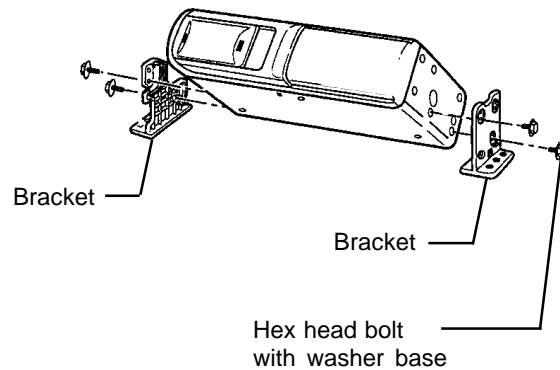

3 Determine the mounting location, and drill four mounting holes.

NOTE: If mounting surface is carpeted, use caution when drilling holes to prevent drill bit from catching on carpet. Cut holes in carpet before drilling into sub-surface.

Never mount the unit near the fuel tank.

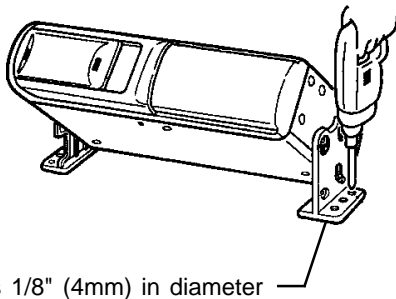

4 Mount the unit in place, using four self-tapping Phillips head screws.

Use RTV (silicone sealer) on screw threads or around the holes to prevent moisture intrusion.

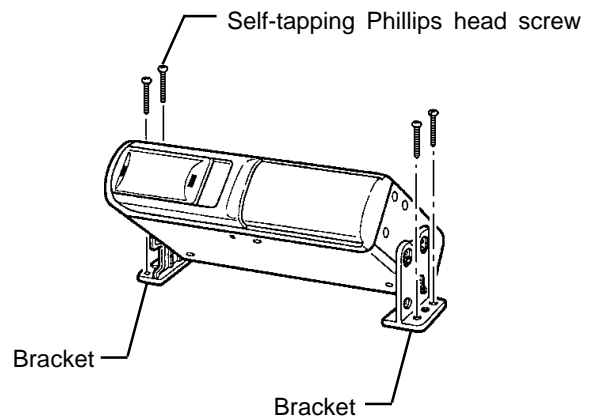

WIRING

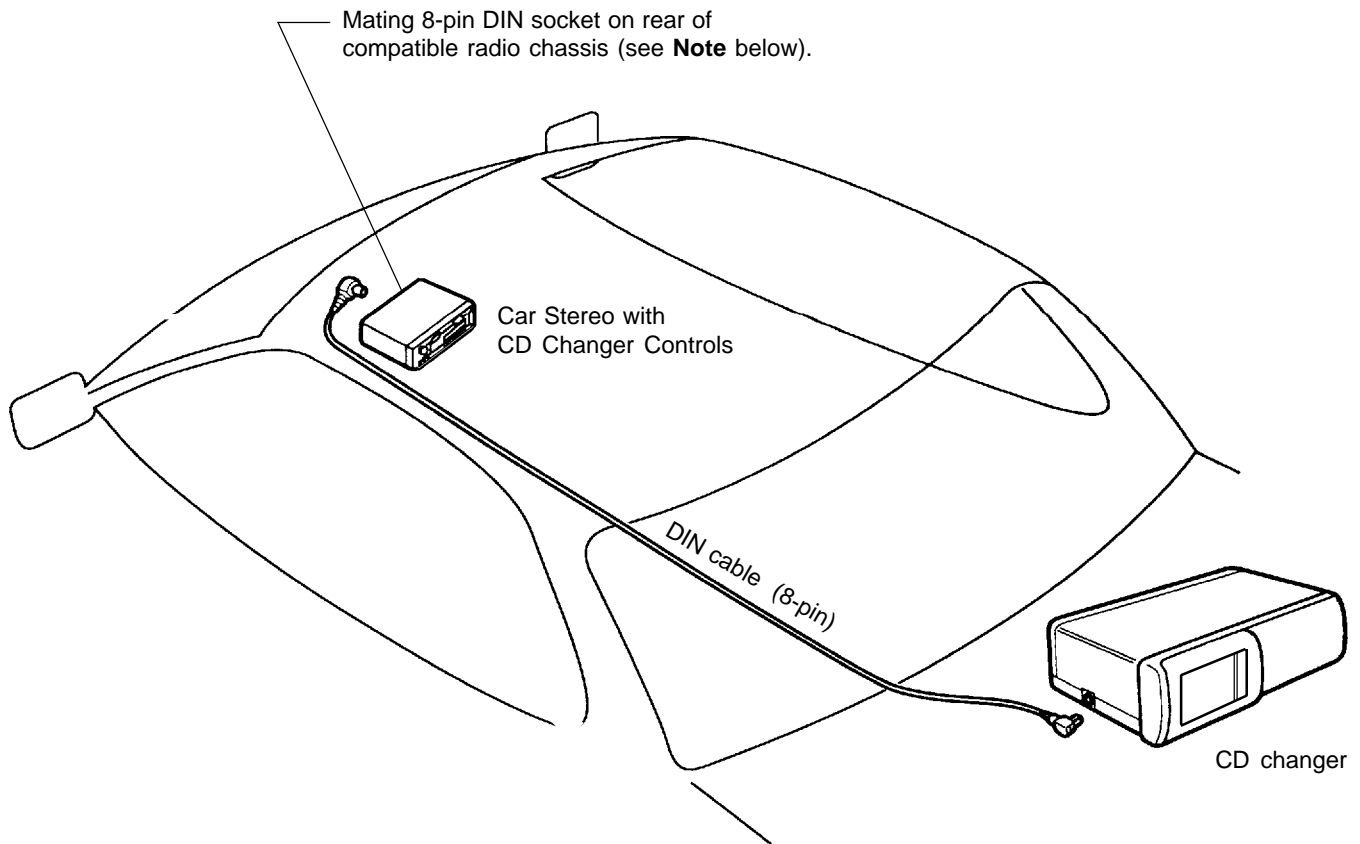

- NOTE:** 1. Check with your Rampage/Audiovox audio dealer to be sure your stereo is directly compatible with this CD changer.
2. When used with Rampage model AV-427 car stereo, be sure Changer Selector switch on bottom of radio chassis is set to position "**B**".

Free Manuals Download Website

<http://myh66.com>

<http://usermanuals.us>

<http://www.somanuals.com>

<http://www.4manuals.cc>

<http://www.manual-lib.com>

<http://www.404manual.com>

<http://www.luxmanual.com>

<http://aubethermostatmanual.com>

Golf course search by state

<http://golfingnear.com>

Email search by domain

<http://emailbydomain.com>

Auto manuals search

<http://auto.somanuals.com>

TV manuals search

<http://tv.somanuals.com>