Thank you for purchasing the Audiovox Model AVD100, AVD200T DVD Player.



This instrument is listed by Underwriter's Laboratories, Inc. It is designed and manufactured to meet rigid U.L. safety standards against X-radiation, fire, casualty and electrical hazards.

Audiovox Electronics Corporation
150 Marcus Blvd.,
Hauppauge, NY 11788



AUDIOVOX®

DVD Player



MODEL AVD100/AVD200T OPERATING INSTRUCTIONS

Safety Precautions

| | | |
|---|---|---|
|  | WARNING RISK OF ELECTRIC SHOCK DO NOT OPEN |  |
| AVERTISSEMENT | RISQUE DE CHOC ELECTRIQUE NE PAS OUVRIR | |
| WARNING : TO REDUCE THE RISK OF ELECTRIC SHOCK, DO NOT REMOVE COVER(OR BACK). NO USER SERVICEABLE PARTS INSIDE. REFER SERVICING TO QUALIFIED SERVICE PERSONNEL. | | |



The lightning flash with arrowhead symbol, within an equilateral triangle, is intended to alert the user to the presence of uninsulated 'dangerous voltage' within the product's enclosure that may be of sufficient magnitude to constitute risk of electric shock to persons.



The exclamation point within an equilateral triangle is intended to alert the user to the presence of important operating and maintenance (servicing) instructions in the literature accompanying the appliance.

WARNING

TO REDUCE THE RISK OF FIRE OR ELECTRIC SHOCK, DO NOT EXPOSE THIS PRODUCT TO RAIN OR MOISTURE.

CAUTION

TO PREVENT ELECTRIC SHOCK, MATCH WIDE BLADE OF PLUG TO WIDE SLOT, FULLY INSERT

ATTENTION

POUR EVITER LES CHOCS ELECTRIQUE, INTRODUIRE LA LAME LA PLUS LARGE DE LA FICHE DANS LA BORNE CORRESPONDANTE DE LA PRISE ET POUSSER JUSQU'AU FOND.

CAUTION

This Digital Video Disc Player employs a Laser System. To ensure proper use of this product, please read this owner's manual carefully and retain for future reference, should the unit require maintenance, contact an authorized service location-see service procedure. Use of controls, adjustments or the performance of procedures other than those specified may result herein hazardous radiation exposure. To prevent direct exposure to laser beam, do not try to open the enclosure. Visible laser radiation when open the enclosure. DO NOT STARE INTO BEAM.

FCC NOTICE

This equipment has been tested and found to comply with the limits for a Class B digital device, pursuant to part 15 of the FCC Rules. Their limits are designed to provide reasonable protection against harmful interference in residential installation. This equipment generates, uses, and can radiate radio frequency energy and, if not installed and used in accordance with the instructions, may cause harmful interference to radio communications. However, there is no guarantee that interference will not occur in a particular installation. If this equipment does cause harmful interference to radio or television reception, which can be determined by turning the equipment off and on, the user is encouraged to try to correct the interference by one or more of the following measures:

- Reorient or relocate the receiving antenna.
- Increase the separation between the equipment and receiver.
- Connect the equipment into an outlet on a circuit different from that to which the receiver is connected.
- Consult the dealer to an experienced radio/TV technician for help.

FCC WARNING

Changes or modifications not expressly approved by the party responsible for compliance could void the user's authority to operate the equipment.

INDUSTRY CANADA REQUIREMENT

This class B digital apparatus meets all requirements of the Canadian Interference-Causing Equipment Regulations.

This product incorporates copyright protection technology that is protected by method claims of certain U.S. patents and other intellectual property right owned by Macrovision Corporation and other rights owners. Use of this copyright protection technology must be authorized by Macrovision Corporation, and is intended for home and other limited viewing uses only unless otherwise authorized by Macrovision Corporation. Reverse engineering or disassembly is prohibited.

RECORD YOUR MODEL NUMBER

The model and serial number of your new DVD player are located on the back of the DVD player cabinet. For your future convenience, we suggest that you record these numbers here :

MODEL NO. _____

SERIAL NO. _____

Important Safety Instructions

WARNING

PLEASE READ AND OBSERVE ALL WARNINGS AND INSTRUCTIONS IN THIS OWNER'S MANUAL AND THOSE MARKED ON THE UNIT, RETAIN THIS BOOKLET FOR FUTURE REFERENCE.

This set has been designed and manufactured to assure personal safety. Improper use can result in electric shock or fire hazard. The safeguards incorporated in this unit will protect you observe the following procedures for installation, use and servicing. This unit is fully transistorized and does not contain any parts that can be repaired by the user.

DO NOT REMOVE THE CABINET COVER, OR YOU MAY BE EXPOSED TO DANGEROUS VOLTAGE. REPER SERVICING TO QUALIFIED SERVICE PERSONNEL ONLY.

1. Read owner's manual

After unpacking this product, read the owner's manual carefully, and follow all the operating and other instructions.

2. Power Sources

This product should be operated only from the type of power source indicated on the making label. If you are not sure of the type of power supply in your home, consult your product dealer or local power company. For products intended to operate from battery power, or other sources, refer to the operating instructions.

3. Ventilation

Slots and openings in the cabinet are provided for ventilation and to ensure reliable operation of the product and to protect and to protect it from overheating. These openings must not be blocked or covered. The openings should never be blocked by placing the product on a bed, sofa, rug or other similar surface. This product should not be placed in a built-in installation such as a bookcase or rack unless proper ventilation is provided or the manufacturer's instructions have been adhered to.

4. Heat

The product should be situated away from heat sources such as radiators, heat registers, stove, or other products(including amplifiers) that produce heat.

5. Water and Moisture

Do not use this product near water-for example, near a bath tub, wash bowl, kitchen sink, or laundry tub; in a wet basement; or near a swimming pool and the like.

6. Cleaning

Unplug this product from the wall outlet before cleaning. Do not use liquid cleaners or aerosol cleaners. Use a damp cloth for cleaning.

7. Power-Cord Protection

Power-supply cords should be routed so that they are not likely to be walked on or pinched by items placed upon or against them, paying particular attention to cords at plugs, convenience receptacles, and the point where they exit from the product.

8. Lightning

For added protection of this product during storms, or when it is left unattended and unused for long periods of time, unplug it from the wall outlet. This will prevent damage to the product due to lightning and power-line surges.

9. Object and Liquid Entry

Never push objects of any kind into this product through openings as they may touch dangerous voltage points or short-out parts that could result in a fire or electric shock. Never spill liquid of any kind on the product.

10. Attachments.

Do not use attachments not recommended by the product manufacturer as they may cause hazards.

11. *Accessories*

Do not place this product on an unstable carts, stand, tripod, bracket, or table. The product may fall, causing serious injury to a child or adult, and serious damage to the product. Use only with a cart, stand, tripod, bracket, or table recommended by the manufacturer, or sold with the product. Any mounting of the product should follow the manufacturer's instructions, and should use a mounting accessory recommended by the manufacturer. A product and cart combination should be moved with care. Quick stops, excessive force, and uneven surfaces may cause the product and cart combination to overturn.



12. *Disc Tray*

Keep your fingers well clear of the disc tray as it is closing. It may cause serious personal injury,

13. *Burden*

Do not place a heavy object on or step on the product. The object may fall, causing serious personal injury and serious damage to the product.

14. *Connecting*

When you connect the produce to other equipment, turn off the power and unplug all of the equipment. Failure to do so may cause an electric shock and serious personal injury. Read the owner's manual the other equipment carefully and follow the instructions when making any connections.

15. *Sound Volume*

Reduce the volume to the minimum level before you turn on the product. Otherwise, sudden high volume sound may cause hearing or speaker damage.

16. *Sound Distortion*

Do not allow the product to output distorted sound for a longtime. It may cause speaker overheating and fire.

17. *Headphones*

When you use the headphones, keep the volume at a moderate level. If you use the headphones continuously with high volume sound, it may cause hearing damage.

18. *Laser Beam*

Do not look into the opening of the disc tray or ventilation opening of the product to see to source of the laser beam. It may cause sight damage.

19. *Disc*

Do not use a cracked, deformed, or repaired disc. These discs are easily broken and may cause serious personal injury and produce malfunction.

20. *Damage Requiring Service*

Unplug this product from the power source and refer servicing to qualified service personnel under the following conditions:

- a) When the power-supply cord or plug is damaged.
- b) If liquid has been spilled, or objects have fallen into the product.
- c) If the product has been exposed to rain or water.
- d) If the product does not operate normally by following the operating instructions. Adjust only those controls that are covered by the operating instructions as an improper adjustment of controls may result in damage and will often require extensive work by a qualified technician to restore the product to its normal operation.
- e) If the product has been dropped or damaged in any way.
- f) When the product exhibits a distinct change in performance-this indicates a need for service.

21. *Servicing*

Do not attempt to service this product yourself as opening or removing covers may expose you to dangerous voltage or other hazards. Refer all servicing to qualified service personnel.

22. *Replacement parts*

When replacement parts are required, be sure the service technician has used replacement parts specified by the manufacturer or have the same characteristics as the original part. Unauthorised substitutions may result in fire, electric shock, or other hazards.

23. *Safety Check*

Upon completion of any service or repairs to this product, ask the service technician to perform safety checks to determine that the product is in proper operating condition.

Contents

● Introduction

- Before reading this user's manual _____ 3
- What is DVD? _____ 3
- Regional codes _____ 4
- Checklist for accessories _____ 4
- Name of DVD player _____ 5
- Remote controller _____ 7
- DVD Menu _____ 8
- TV Menu(option for AVD200T) _____ 8

● Connecting to TV and Amplifier

- Connecting only to the TV _____ 9
- Connecting to TV / Audio _____ 10
- Connecting to Dolby Pro Logic support amplifier _____ 11
- Connecting to Dolby Digital support amplifier _____ 12

● Using the Remote Control Functions

- Inserting and ejecting Discs _____ 13
- Playback and Stop _____ 13
- Searching for specific scene / song _____ 14/15
- Repetitive playback _____ 16

- Changing the subtitle and vocal language _____ 17
- Setting the volume and sterephonic sound functions _____ 18
- Screen enhancement and viewing different angles _____ 19
- Viewing menu installed in discs and setup menu _____ 20
- Viewing functions after turning off the playback control mode _____ 21
- Using the TV and External mode _____ 22
- Viewing the playback time, title, and chapter status _____ 23

● Settings and Controls from menu

- Language settings _____ 24
- Display settings _____ 25
- Sound settings _____ 26
- User settings _____ 27

● Miscellaneous

- Definition of terms _____ 28
- Checklist for users when player seems to be broken _____ 29
- Device standard _____ 31

Introduction

Before reading this user's manual

Explanation of icons



The device could be set and used with remote control.



It is available when the disc which will be played is DVD.



It is available when the disc which will be played is VCD.



It is available when the disc which will be played is CD.



It is available when the disc which will be played is MP3.



Advices and reference information needed before using the device.



What is DVD?

DVD (Digital Versatile Disc or Digital Video Disc) technology consists of MPEG2 image compression and Dolby Digital Stereophonic Surround audio system. It enables up to 32 subtitle languages, 8 vocal languages, 9 different camera angle views, and sets up internal view ratings. DVD provides movie theater quality visual and audio.

Discs that can be played with the current device.

| | | | | | |
|-----|-----|----|------|-------|---------------------------------|
| DVD | VCD | CD | CD-R | CD-RW | CD-R/RW with MP3/MPG recordings |
|-----|-----|----|------|-------|---------------------------------|



LD discs cannot be played with the current device.

Regional codes

Region Management Information

Region Management Information : This DVD Player is designed and manufactured to respond to the Region Management Information that is recorded on a DVD disc. If the Region number described on the DVD disc does not correspond to the Region number of this DVD player, this DVD player cannot play that disc.

-  USA, Canada, and other North and Central American countries.
-  Japan, Europe (excluding Eastern Europe), Middle East
-  Korea and South-Eastern Asia
-  Oceania such as Australia, New Zealand, south America countries
-  India, Eastern Europe and Africa
-  China
-  All countries

Checklist for accessories

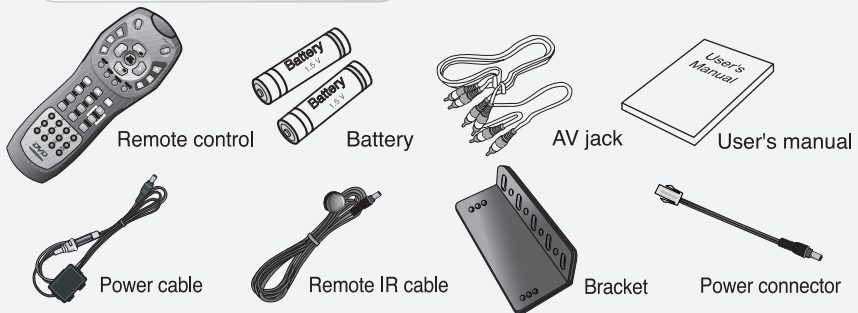

Main Components

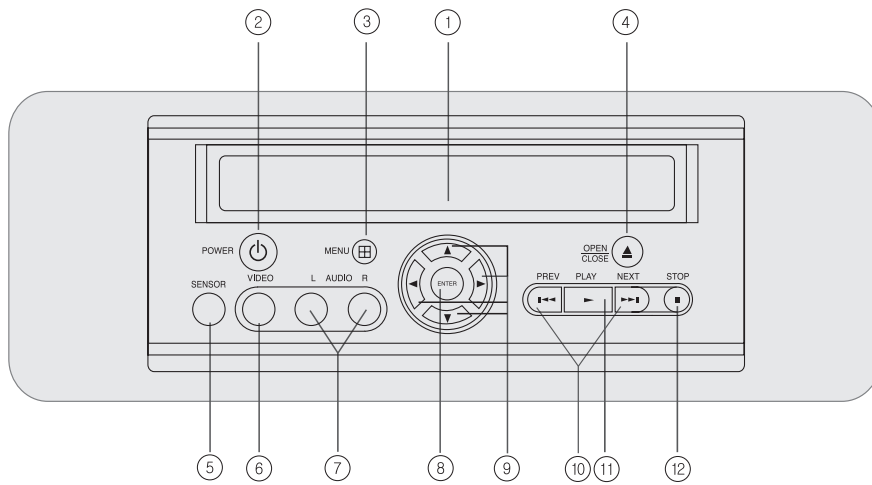

- ① DISC Tray
- ② Power Button
- ③ Menu button
- ④ Tray open/close button
- ⑤ Infrared Remote sensor
- ⑥ External Video input
- ⑦ External Audio input(L,R)
- ⑧ Enter button
- ⑨ Arrow buttons
- ⑩ Previous/Next button
- ⑪ Play button
- ⑫ Stop button

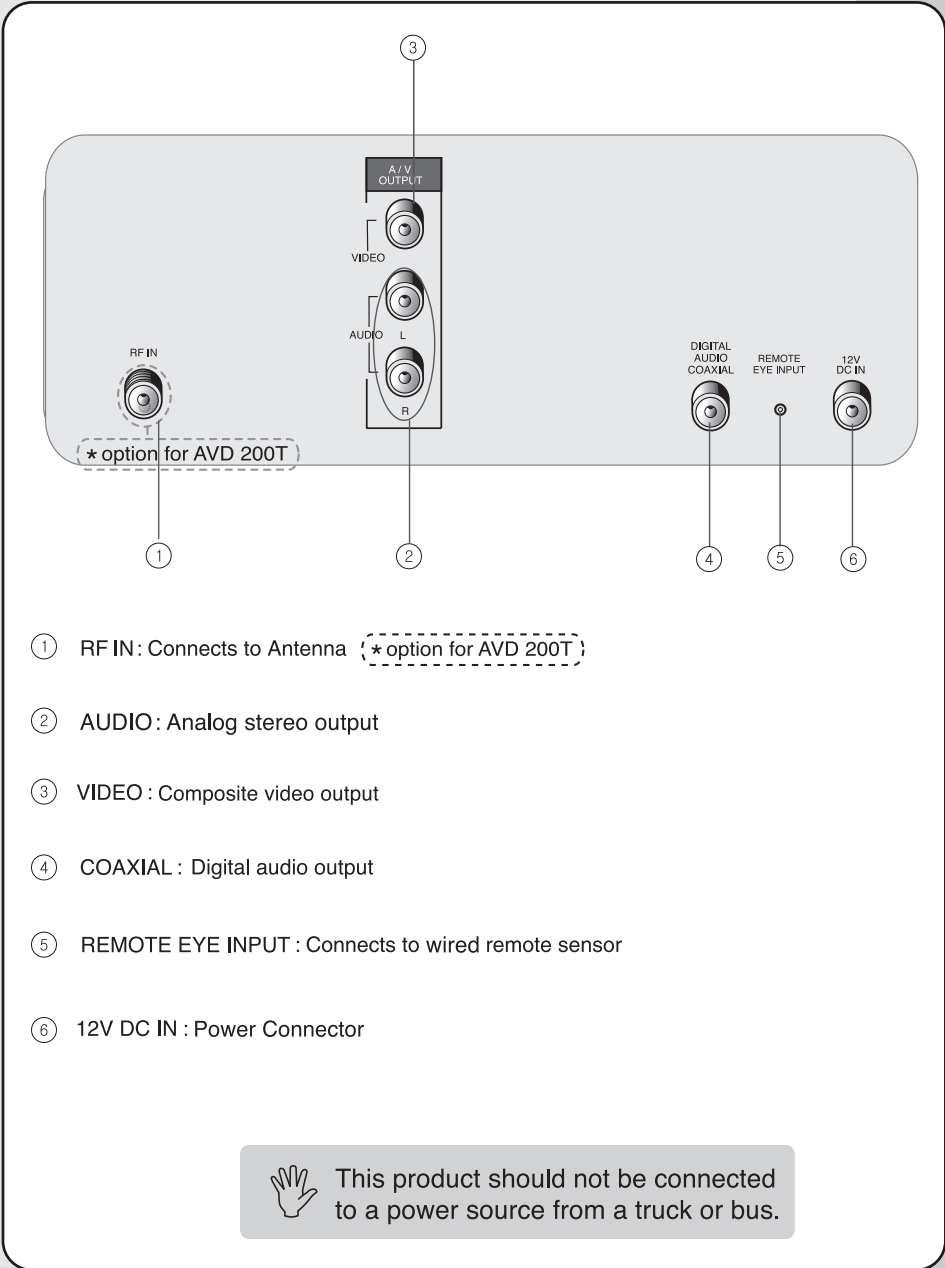

Remote controller



DVD MENU

| | | |
|---|------------------------|---|
| ① | POWER | For turning power On/Off |
| ② | OPEN/CLOSE | For Opening and Closing the disc tray. |
| ③ | SLOW | For slow playback (Use the right, left arrow button) |
| ④ | STOP/RETRUN | For stopping playing or going to previous menu display on setup |
| ⑤ | STEP/PAUSE | For playing one frame at a time (use ◀ ▶ buttons) |
| ⑥ | NEXT/PREV | For skipping to the next, previous chapter or track |
| ⑦ | FAST | For fast playback (Use the right, left arrow button) |
| ⑧ | PLAY/ENTER | For starting Playback or selecting a Menu Option. |
| ⑨ | UP,DOWN RIGHT, LEFT | For selecting item on menu or playback speed control |
| ⑩ | DVD/TV/EXT. | For selecting the Output. |
| ⑪ | SETUP | For initial user setting |
| ⑫ | TITLE MENU | For displaying the title menu contained in the disc. |
| ⑬ | MENU | For displaying the menu contained in the disc |
| ⑭ | 3D | For stereophonic sound effect |
| ⑮ | PBC | For setting the PlayBackControl(PBC) |
| ⑯ | MUTE | For volume mute on or off |
| ⑰ | A-B | For specifying and repeating playback of a section. |
| ⑱ | VOLUME | For volume control in a CD, VCD or MP3. |
| ⑲ | REPEAT | For repeated playback of disc title, chapter, track |
| ⑳ | AUDIO | For selecting the audio language. |
| ㉑ | SUBTITLE | For selecting the subtitle language. |
| ㉒ | ANGLE | For viewing with a different frame angle |
| ㉓ | ZOOM | For magnifying the screen |
| ㉔ | DISPLAY | For checking the current disc status. |
| ㉕ | 1~0, +10 | For direct selecting a chapter or a title number and for password input |

TV MENU * option for AVD 200T

| | | |
|---|------------------------|---|
| ⑧ | PLAY, ENTER or DISPLAY | For viewing the current status. |
| ⑨ | UP,DOWN RIGHT, LEFT | For channel changing For volume control. |
| ⑲ | SCAN (◀ ▶) | For automatic channel search. |
| ㉑ | SAV/ERS | For saving or erasing channels. |
| ㉑ | SUBTITLE | For clear backscreen. |

Connecting to TV and Amplifier

Connecting only to the TV

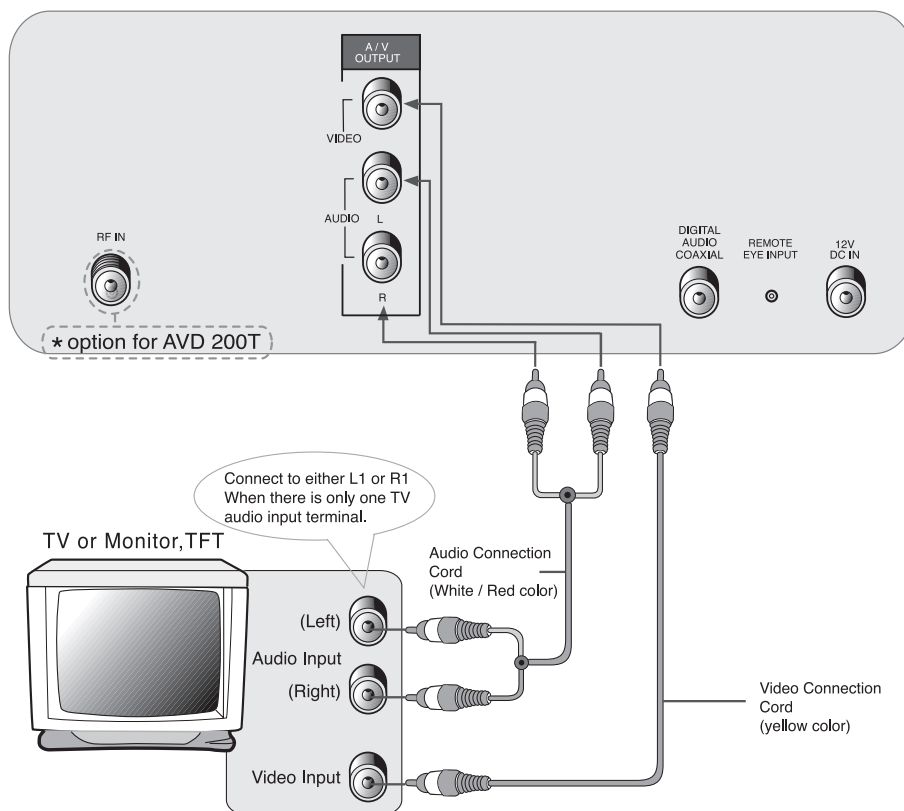

Connecting to TV / Audio

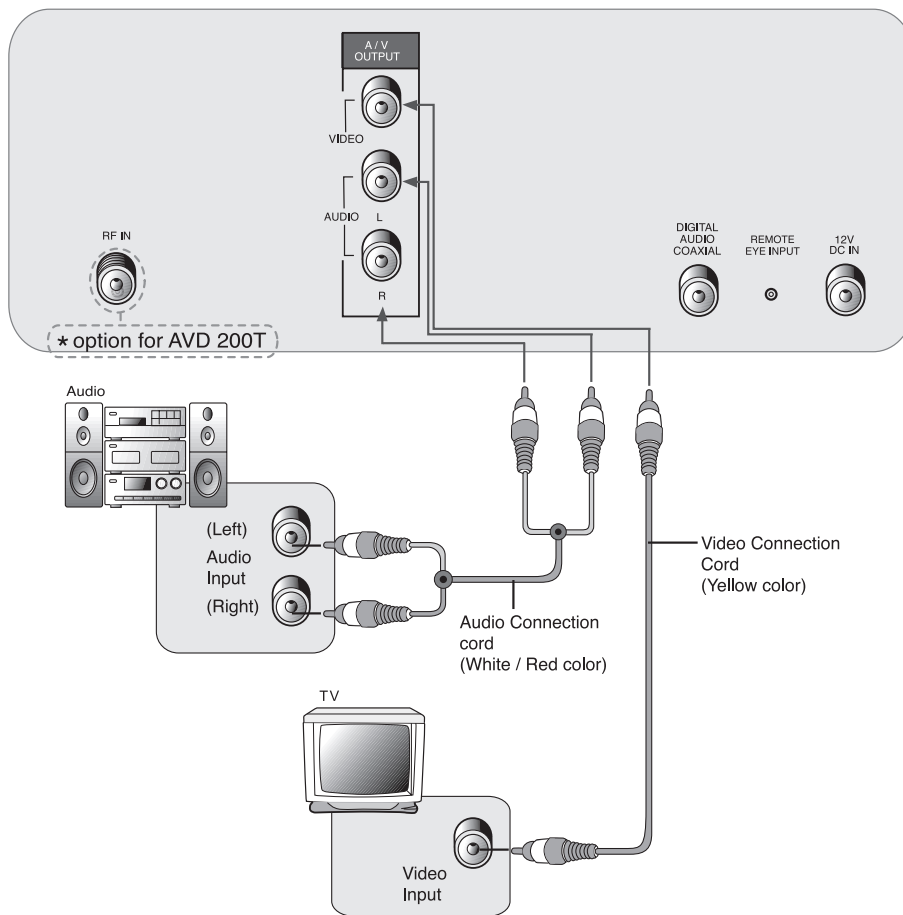

Connecting to Dolby Pro Logic support amplifier

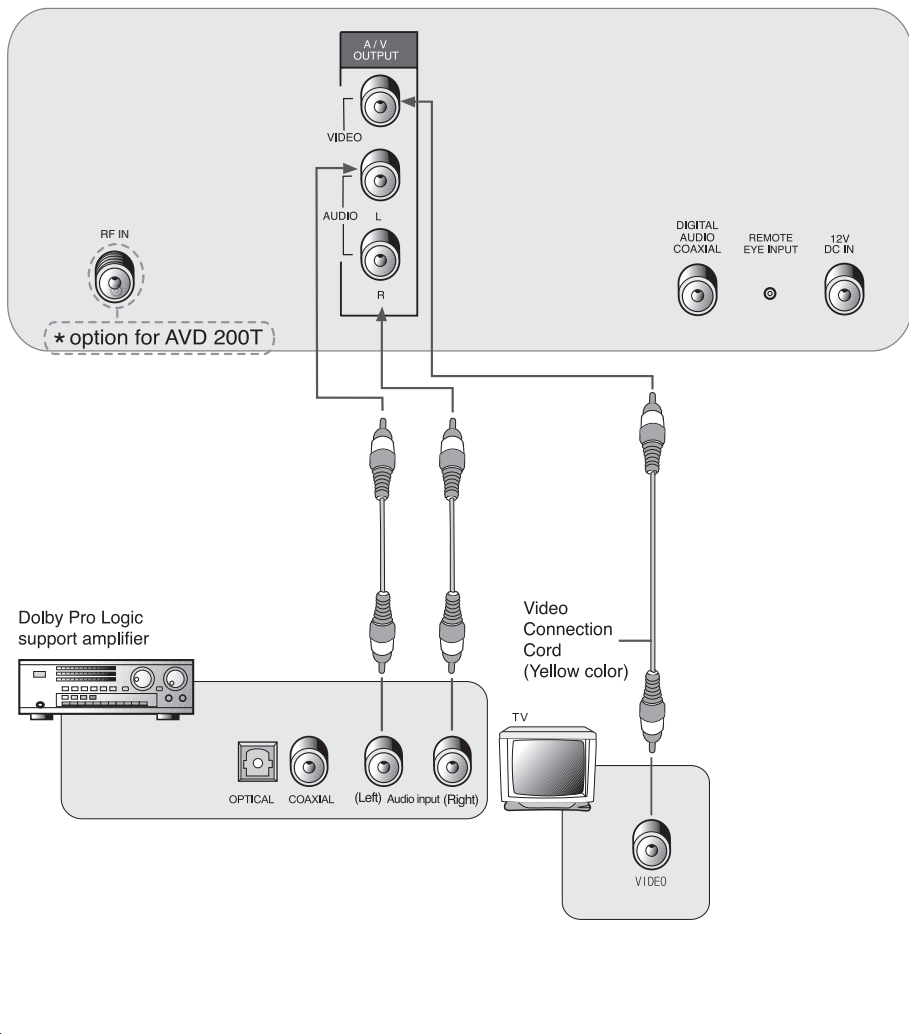

Connecting to Dolby Digital support Amplifier

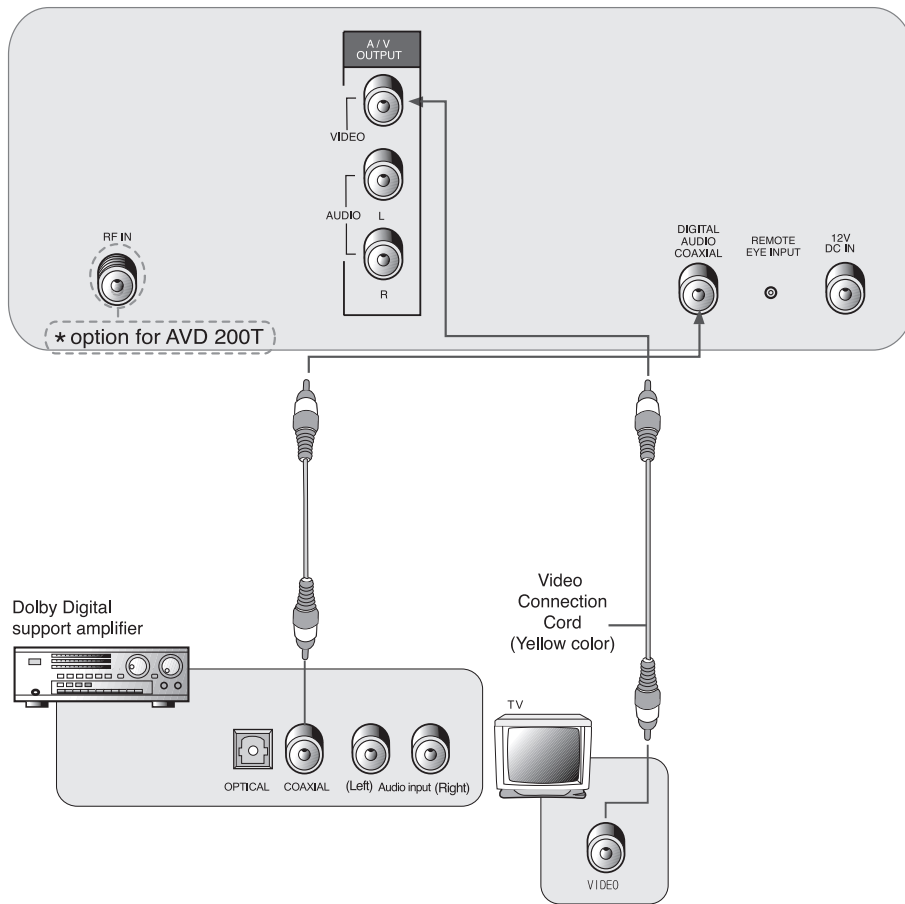

Using the Remote Control Functions

Inserting and ejecting Discs

- 1 When the tray opens, insert the disc properly with the Label on the upper part of it.
- 2 As the tray closes, playback is automatically executed.



Discs playable through DVD player - DVD, VCD, CD, CD-R, CD-RW with MP3 or MPEG 1 file recordings

* LD is not playable

Playback and Stop

- 1 To temporarily stop playback, press STOP button once. The Player saves in the internal memory of the exact position where it was stopped, and it will playback again at that position.

When desired to playback from the beginning, press the STOP button twice.



For some VCDs, stop mode is possible by pressing the NEXT button.

- 2 To Playback again, Press the PLAY(ENTER) button.



Searching for specific scene / song

Searching by selecting the chapter number

- 1 Pressing the GOTO button once will display the chapter number, and when pressed twice, it will display the time.
- 2 Input the chapter number and time that is desired and press Enter.
- 3 The player will play from the number or time that it reads.

MP 3 In case of mp3 disc, Step 1 is not necessary. For Mp3/CD, Each time (+10) button is pushed, it will increase the song number by 10 .

Searching by using chapters

- 1 The player will automatically transfer to the next or previous chapter from the current chapter being played when pressing the PREV, NEXT button.
- 2 When pressing PREV, it will transfer to previous chapter of the chapter currently being played.
- 3 The chapter transfer status is displayed on the upper part of the screen.

MP 3 While playing mp3 disc, Press PREV, NEXT button to select the previous or next song. When mp3 disc is stopped, Press UP,DOWN button to select the song.



Searching for specific scene / song

Search by using playback speed

1 Search by Fast forwarding and review.
Press the Fast button and adjust the direction and speed by using the right or left button.
(2X, 4X, 6X, 8X, 12X, 16X, 32X, 64X)

 For some discs, increasing speed by 2X, 4X, 8X, is possible by pressing the FAST button.

2 Search by Slow forwarding and review.
Press the SLOW button and adjust the speed and direction by using the right or left button.
(1/2X, 1/4X, 1/8X, 1/16X)

 For some discs, decreasing speed by 1/2X, 1/4X, 1/6X, 1/8X is possible by pressing the SLOW button

3 Search by watching one scene at a time.
Press the PAUSE/STEP button and set the direction, forwarding and review, by using the right or left button.

 For some discs, search by scene is possible by pressing the PAUSE/STEP button.

 For normal speed playback, press the PLAY (ENTER) button.



Repetitive playback

To repeat a specific section

- 1 Pressing the REPEAT button once, the currently playing chapter or the track will be replayed repetitively.
- 2 Pressing the button twice, the currently playing title or CD will be played repetitively. (TITLE REPEAT ON)
- 3 Pressing the button three times, the repeat function will be turned off. (REPEAT OFF)

MP 3 In case of mp3 disc, Press the REPEAT button to change the play mode.

To repeat a specific section

- 1 Choose the section to be repeated by pressing the A-B button. (A TO B SET A)
- 2 Pressing the button twice will enable you to choose the finishing part of the section. (A TO B A-B REPEAT)
- 3 Pressing the button three times will enable you turn off the repetitive function. (A TO B CANCELLED)



Changing the subtitle and vocal language

changing the subtitle language

1 If the disc contains caption data, press the SUBTITLE Button to choose a specific language.
(ex : SUBTITLE 02/02 : KOREAN)

2 (SUBTITLE OFF) shows that there are no subtitles.

 This function might not work with some disc formats.

changing the vocal language

1 If the disc contains vocal language data, press the AUDIO button to choose various information for the language.
(ex : AUDIO 1/2 AC-3, 5.1CH ENGLISH)

 This function might not work with some disc formats.



Setting the volume and stereophonic sound functions

Setting the volume

1 Press the VOLUME +, - button to adjust the volume.

 The sound volume can be controlled only when using the disc is not DVD. Most of all cases, VCD, CD is available for volume control. For further volume control, please use the amplifier or the TV volume control button.

2 Press the MUTE button to temporarily mute the sound.

Adjusting the stereophonic sound function

1 Press the 3D button to choose the type of stereophonic sound.

 This function is only available when the Downmix is set on 2CH.

 VCD, CD, MP3 discs can access this option.



Screen enhancement and viewing different angles

To enlarge a picture

- 1 Pressing the ZOOM button would allow the picture to be enlarged by 1.5X, 2X, 4X.
- 2 Up, down, left, right buttons allow the enlarged picture to be shifted.
- 3 To resume normal settings, press the ZOOM button again.
(ZOOM OFF)

Viewing different angles

- 1 Angle indicator appears on the upper part of DVD player display. When the Angle indicator appears, use the ANGLE button to view screen in various angles.

 This function might not be working in some discs.



Viewing menu installed in discs and setup menu

Viewing menu installed in discs

- 1 Menu installed in discs appears when pressing the MENU button. The menu must be previously saved in the disc.
- 2 Use the arrow buttons to select the desired item on the menu and press Enter.

 The Player could use the T.MENU button instead of the MENU button depending on the type of disc used.

Viewing the setup menu

- 1 Pressing the SETUP will display the set up menu. This allows the user to select DVD options (Language, Display, Audio and Parental).
- 2 To go to a previous screen, press the STOP / RETURN button.

 When using VCD, CD, CD-R, CD-RW, discs, going to setup menu while on playback mode is not possible.



Viewing functions after turning off the playback control mode

- 1 Pressing the PBC Button once will turn on the playback control. Pressing the PBC Button twice will display the elapsed play time, number of titles, vocal information, subtitle information, image and sound information.
- 2 Pressing the PLAY button will resume playback.
- 3 Pressing the MENU button after step 2 would allow users to confer 9 chapters to each desired image in one title. Each conferred images are then played in the sequence of their numbers.
When one title exceeds 9 chapters, use the PREV, NEXT buttons to select next group of conferred chapters.



Using the TV and External mode

< For watching TV, press the DVD/TV/EXT BUTTON >

Searching for TV channel

* option : option for AVD 200T

- 1 When no channels are stored, use the number key for direct channel accessing.
- 2 When some channels are stored, button is used to move channel UP or DOWN direction.
- 3 For automatic channel searching, press the REPEAT button and then press the LEFT or RIGHT button.
- 4 To store or delete favorite channels, press the A-B button and then press ENTER button.

Other controls

- 1 The volume controls LEFT, RIGHT arrow button or VOLUME +,- buttons are available.
- 2 If OSD is not visible from the TV, use the SUBTITLE button.
- 3 Pressing the ENTER button will show the channel information.



When External mode, only mute controls are possible.



Viewing the playback time, title, and chapter status

- 1** Pressing the DISPLAY button will allow the user to see the title and chapter number, enlarge time of the currently playing disc on the upper part of the screen.
- 2** Pressing the button again will show the remaining time of the currently playing title.
- 3** Pressing the button once more will show the elapsed time of the currently playing chapter.
- 4** Pressing the button once more will show the remaining time of the currently playing chapter on the upper part of the screen.
- 5** Pressing the button once more again will turn the display off.



Settings and Controls from menu

Language settings

Display settings

Sound settings

User settings



Language settings



From the SETUP MENU, use the ▲▼ buttons to select LANGUAGE SETUP.

- 1** OSD LANGUAGE
Selects language used in SETUP MENU.
- 2** AUDIO
Selects the vocal language recorded into title.

 Adjusting can only be done when playback mode is off. Make sure to stop playback before doing any adjusting.

- 3** SUBTITLE
Selects the language for captions.

 Adjusting can only be done when playback mode is off. Make sure to stop playback before doing any adjusting.

- 4** DISC MENU
Selects the menu language that the disc supports.

 Adjusting can only be done when playback mode is off. Make sure to stop playback before doing any adjusting.

Display settings

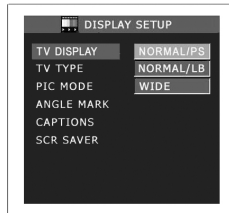

From the SETUP MENU, use the ▲▼ buttons to select DISPLAY SETUP.

1 TV DISPLAY

From TV DISPLAY use the ► button to display the options listed below. Use the ▲▼ buttons to navigate between options.

- PAN & SCAN : When viewing a 16 : 9 image through a 4 : 3 screen, the remainder part of both sides are cut out.
- LETTER BOX : When viewing a 16 : 9 image through a 4 : 3 screen, a black belting on the lower and upper part of the screen is formed to show the complete screen image.
- WIDE : Used when connecting to a wide screen TV.

2 TV TYPE

From TV TYPE use the ► button to display the options listed below. Use the ▲▼ buttons to navigate between options.

- MULTI : Outputs the original image signal of PAL or NTSC recorded into title. Only select this option when user's TV supports both systems.
- NTSC : Modifies the original image signal to NTSC system before playing images.
- PAL : Modifies the original image signal to PAL system before playing images.

3 PIC MODE

From PIC MODE use the ► button to display the options listed below. Use the ▲▼ buttons to navigate between options.

- AUTO : Automatically sets up according to the status of the screen.
- HI-RESOLUTION : Enhances the clarity of the screen.
- ANTI-FLICKER : Prevents screen trembling.

4 ANGLE MARK

From ANGLE MARK use the ► button to display the options listed below. Use the ▲▼ buttons to navigate between options.

When playing DVD Titles that can be viewed from different angles, camera icon appears on the upper part of the screen.

5 CAPTIONS

From CAPTION use the ► button to display the options available. Use the ▲▼ buttons to navigate between options.

adjusts caption selections.

6 SCREEN SAVER

From SCREEN SAVER use the ► button to display the options available. Use the ▲▼ buttons to navigate between options.

In order to protect screen when the screen is left unused for some time, it automatically executes screen savers.
(In 10 minutes the screen saver goes on, in 1 hours the device will go into stand-by mode automatically.)

Sound settings

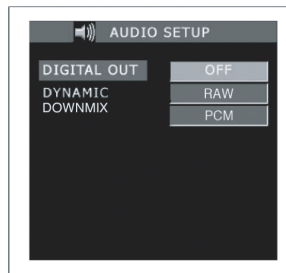

From the SETUP MENU, use the ▲▼ buttons to select AUDIO SETUP.

1 DIGITAL OUT

From DIGITAL OUT use the ► button to display the options available.
Use the ▲▼ buttons to navigate between options.

Adjust the output of digital audio terminal.

2 DYNAMIC RANGE

From DYNAMIC RANGE use the ► button to display the options available.
Use the ▲▼ buttons to navigate between options.

Signifies the dynamic range of Dolby Digital sound. Used when it is difficult to hear dialogues through stereo system or TV. This function is only supported by DVD Titles with DRC properties.

3 DOWNMIX

From DOWNMIX use the ► button to display the options available.
Use the ▲▼ buttons to navigate between options.

• 2CH

- LT / RT : Selected only when the amplifier has Dolby Pro Logic support.
- STEREO : Selected when listening to general stereo sound.
- VSS (Virtual Surround System) : Selected when listening through virtual surround system.

User settings

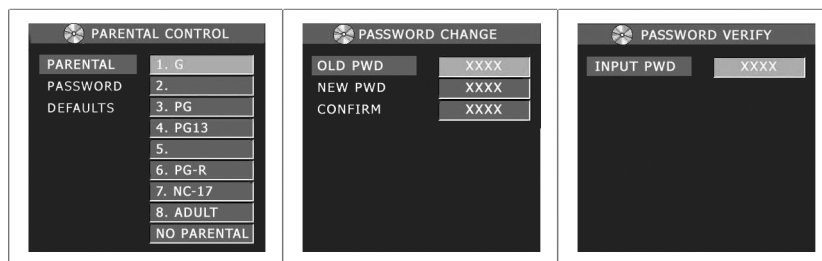

From the SETUP MENU, use the ▲▼ buttons to select PARENTAL CONTROL.

1 PARENTAL

From PARENTAL use the ► button to display the options available.
Use the ▲▼ buttons to navigate between options.

There are several levels of viewer rating settings that can be selected.
Use the ▲▼ buttons to navigate between settings.

2 PASSWORD

From PASSWORD use the ► button to display the Change option.

Select the CHANGE option and press ENTER
(the user will be prompted to enter Previous Password)

- First time setup: enter the Default password = 0000 and press ENTER
- Change previously set passwords: enter the current password and press ENTER
Input New Password then re-enter New Password to confirm then press ENTER

3 DEFAULT

Returns the player back to default settings. The user needs to know the password.

Miscellaneous

Definition of terms

| TERM | CONTENT |
|---------------|---|
| DOLBY DIGITAL | As a form of medium for compressed digital sound recording, it corresponds with the 5.1 channel surround system. This system has the rear channels be stereo and separates the woofer channels completely which enables the users to enjoy the best digital experience. |
| TITLE | The largest playback unit of images or music recorded in DVD. Each title has a title number that simplifies the song selecting process. |
| CHAPTER | A smaller playback unit than title of recorded images and music on a DVD. Several chapters compose a Title. |
| SUBTITLES | Captioning on the bottom part of the screen which shows translated dialogues. Up to 32 national languages can be supported when producing a Title. |
| ANGLE | TV images are generally represented through a viewpoint of camera. However, DVD allows a choice of up to 9 different camera angles by recording various simultaneous camera footage angles. ★ This feature is only available if the DVD Supports Angle Functions. |

Checklist for users when player seems to be broken

When the power does not turn on

- Check if the power cord is well connected to the rear of the unit
- Check if the battery supply of the remote control is used up.

When the disc fails to play

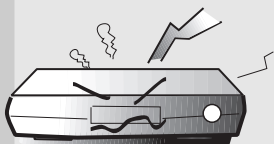

- Check if the disc is inserted properly into the tray.
- Check if the disc has viewing restriction selected.
- Check if the disc is of proper regional code.
- Not all discs are playable in the DVD. Check with the beginning part of the manual on whether the disc is playable.
- Check whether the interior part of the player was affected by dew condensation. (If it was affected, wait for 1 hour before playing the DVD)

When camera angles cannot be changed

- The disc being played does not support ANGLE functions.
- In order to check whether the disc supports the ANGLE functions, see if the ANGLE indicator on the upper part of the main display is illuminated.

When subtitles cannot be changed

- The disc being played does not support subtitle functions.
- The disc is prohibited from changing subtitle languages.

When vocal languages (AUDIO) cannot be changed

- The disc being played does not support AUDIO properties.
- The disc is prohibited from changing vocal languages(AUDIO).

- When there is no sound output

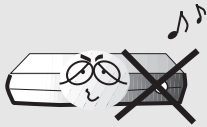

Check whether the player is in slow or fast playback mode. (if it is the case, then just press play button for normal playback)

Check whether the MUTE button is on.

Check whether the AV cord is properly connected.

Check if the sound setting in the setup menu is done properly.
- When the player does not operate properly

The player does not operate properly when static electricity is abundant in the player surroundings. In such cases, turn off the power button or pull the power plug out of the rear of the unit and plug the power back in.
- When too much time is consumed for playback after pressing the play button or after using the setup menu

In order to protect player's interior motors, it takes a couple of minutes for playback after using the setup menu for a quite some time, or after pressing the play / stop/ eject/ buttons in a rapid sequence. This is a normal process for the player.
- When the remote control doesn't work

Check if the distance or angle from the player is not too far, or whether there are objects in between the player and the remote control.

Check if the battery supply is used up.
- When it is not possible to use the setup menu while starting to play disc

Setup menu can only be used when disc is being played, loaded, and tray is open.
- When the setup menu of the product does not operate

The setup menu only operates according to the specific manufacturing properties of DVD disc. Only discs that are of compatible setup menu properties with the player can be played in the DVD player.
- When the TV MODE or TV TYPE functions do not work

The DVD disc may not support this function.

Device Standard

| | | |
|---------------------------|---|---|
| General Specification | Power Supply | DC 12V |
| | Net Electrical Consumption | 24W |
| | Weight | 2.0Kg |
| | Size | 170(W) x 251(D) x 73(H) mm |
| | Recommended functioning temperature | +5°C ~ 45°C |
| | Recommended functioning humidity | 10% ~ 75% |
| Disc Available | DVD (Digital Versatile Disc) | Liner velocity : 3.49m / sec |
| | | maximum playback time : 135 minutes |
| | CD (Compact Disc) : 12Cm | Liner velocity : 1.2 ~ 1.4m / sec |
| | | maximum playback time : 74 minutes |
| Video-CD : 12Cm | Liner velocity : 1.2 ~ 1.4m / sec | |
| | Maximum playback time : 74 minutes (motion picture + sound) | |
| Video Output | Composite Video | 1.0V p-p (electrical load of 75ohm) |
| Audio Output | 2 Channel | left, right |
| | Output Level | analog audio : 2Vrms(1kHz) |
| | | digital audio : 1.15V p-p |
| | Frequency Response | 48kHz sampling : 4Hz ~ 22kHz |
| | | 96kHz sampling : 4Hz ~ 44kHz |
| | S/N Ratio | 106dB |
| Dynamic Range | 106dB | |
| Total Harmonic Distortion | 0.002% | |
| TV input | Channel Frequency * option for AVD 200T | VHF : 55.25MHz ~ 211.25MHz UHF : 471.25MHz ~ 801.25MHz |

Manufactured under license from Dolby Laboratories. "Dolby", and the double-D symbol are trademarks of Dolby Laboratories. Confidential unpublished works.
©1992-1997 Dolby Laboratories, Inc. All rights reserved.

36 MONTH LIMITED WARRANTY

Applies to Audiovox Mobile Video Products

AUDIOVOX ELECTRONICS CORPORATION (the Company) warrants to the original retail purchaser of the product that should this product or any part thereof, under normal use and conditions, be proven defective in material or workmanship within 12 months from the date of original purchase, such defect(s) will be repaired or replaced with reconditioned product (at the Company's option) without charge for parts and repair labor.

To obtain repair or replacement within the terms of this Warranty, the product is to be delivered with proof of warranty coverage (e.g. dated bill of sale), specification of defect(s), transportation prepaid, to the Company at the address shown below.

This Warranty does not extend to the elimination of externally generated static or noise, to correction of antenna problems, to costs incurred of installation, removal or reinstallation of the product, or to damage to tapes, discs, speakers, accessories, or vehicle electrical systems.

This Warranty does not apply to any product or part thereof which, in the opinion of the Company, has suffered or been damaged through alteration, improper installation, mishandling, misuse, neglect, accident, or by removal or defacement of the factory serial number/bar code label(s). THE EXTENT OF THE COMPANY'S LIABILITY UNDER THIS WARRANTY IS LIMITED TO THE REPAIR OR REPLACEMENT PROVIDED ABOVE AND, IN NO EVENT, SHALL THE COMPANY'S LIABILITY EXCEED THE PURCHASE PRICE PAID BY PURCHASER FOR THE PRODUCT.

This Warranty is in lieu of all other express warranties or liabilities. ANY IMPLIED WARRANTY OF MERCHANTABILITY, SHALL BE LIMITED TO THE DURATION OF THIS WRITTEN WARRANTY. ANY ACTION FOR BREACH OF ANY WARRANTY HERE UNDER INCLUDING ANY IMPLIED WARRANTY OF MERCHANTABILITY MUST BE BROUGHT WITHIN A PERIOD OF 24 MONTHS FROM DATE OF ORIGINAL PURCHASE. IN NO CASE SHALL THE COMPANY BE LIABLE FOR ANY CONSEQUENTIAL OR INCIDENTAL DAMAGES FOR BREACH OF THIS OR ANY OTHER WARRANTY, EXPRESS OR IMPLIED, WHAT SO EVER. No person or representative is authorized to assume for the Company any liability other than expressed herein in connection with the sale of this product.

Some states do not allow limitations on how long an implied warranty lasts or the exclusion or limitation of incidental or consequential damage so the above limitations or exclusions may not apply to you. This Warranty gives you specific legal right and you may also have other rights, which vary from state to state.

U.S.A : AUDIOVOX ELECTRONICS CORPORATION, 150 MARCUS BLVD.,
HAUPPAUGE, NEW YORK 11788 0 1-800-645-4994

CANADA : CALL 1-800-645-4994 FOR LOCATION OF WARRANTY STATION
SERVING YOUR AREA

128-5148B

Free Manuals Download Website

<http://myh66.com>

<http://usermanuals.us>

<http://www.somanuals.com>

<http://www.4manuals.cc>

<http://www.manual-lib.com>

<http://www.404manual.com>

<http://www.luxmanual.com>

<http://aubethermostatmanual.com>

Golf course search by state

<http://golfingnear.com>

Email search by domain

<http://emailbydomain.com>

Auto manuals search

<http://auto.somanuals.com>

TV manuals search

<http://tv.somanuals.com>