

MMD11 A

11" OVERHEAD LCD MONITOR WITH DVD PLAYER

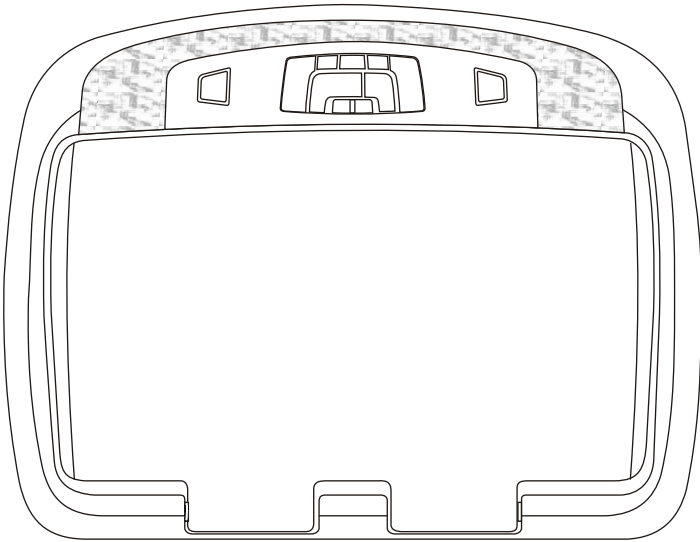

OPERATION MANUAL



128-8652

Important Notice

Installation of overhead products requires careful planning and preparation. Be extremely careful when working on a vehicle with side curtain air bags. Do not route wires near any portion of the side curtain air bag assemblies. This includes any anchor points in A, B, C or D pillars of the vehicle. Routing wires in these areas or running wires by the side curtain air bags can prevent the side curtain air bag from fully deploying which can result in personal injury to vehicle occupants. If you have any questions regarding wire routing in a vehicle, please contact Audiovox Technical Support at 1-800-225-6074.

When connecting power and ground in a mobile video installation ensure that the ACC wire is fused at the point where it is connected to the vehicle ACC wiring. Failure to do so can result in damage to the vehicle if a short circuit develops between the vehicle connection point and the mobile video product.

An LCD panel and/or video monitor may be installed in a motor vehicle and visible to the driver if the LCD panel or video monitor is used for vehicle information, system control, rear or side observation or navigation. If the LCD panel or video monitor is used for television reception, video or DVD play, the LCD panel or video monitor must be installed so that these features will only function when the vehicle is in "park" or when the vehicle's parking brake is applied.

An LCD panel or video monitor used for television reception, video or DVD play that operates when the vehicle is in gear or when the parking brake is not applied must be installed to the rear of the driver's seat where it will not be visible, directly or indirectly, to the operator of the motor vehicle.

Licensed under one or more of the following patents,
Patent NOS. 5,775,762 and 5,927,784

Warnings

- ◆ Do not use any solvents or cleaning materials when cleaning the video monitor.
- ◆ Do not use any abrasive cleaners, they may scratch the screen.
- ◆ Use only a lightly dampened lint free cloth to wipe the screen if it is dirty.
- ◆ Lock the LCD screen in the fully closed position when not in use.
- ◆ Before putting on headphones always adjust the volume setting to the lowest position.
- ◆ Remember to leave the dome light switch in the off or auto positions when the vehicle is unattended, as the dome lights, if left on, can drain the vehicle's battery.
- ◆ Do not put pressure on the screen.
- ◆ Caution children to avoid touching or scratching the screen, as it may become dirty or damaged.

Congratulations

Congratulations on your purchase of the Movies 2 Go MMD11 A DVD Player with Drop-Down Video / Monitor. The MMD11 A has been designed to give you and your family many years of video entertainment in the mobile environment. Please read the directions that follow to familiarize yourself with the product to ensure that you obtain the best results from your equipment.

Please note: Installation options vary, see the individual owner's manuals for each component in your system to obtain a full understanding of each component's operation.

Safety Precaution

For safety reasons, when changing video media it is recommended that the vehicle is not in motion, and that you do not allow children to unfasten seat-belts to change video media or make any adjustments to the system. System adjustments can be accomplished using the remote control, while seat-belts remain fastened. Enjoy your Audiovox entertainment system but remember the safety of all passengers remains the number one priority.

FEATURES

- ◆ 11" TFT (Thin Film Transistor) Active Matrix LCD (Liquid Crystal Display) Monitor
- ◆ Built-in DVD Player
- ◆ Multi-Lingual OSD (On Screen Display) for Control of Picture Quality and Functions
- ◆ Infrared Transmitter for use with Optional IR Wireless Headphones
- ◆ Three Audio / Video Source Inputs (DVD, AUX,AV1)
- ◆ Dome Lights with Built-in Three Way Switch
- ◆ Built-in 16 Channel Frequency Wireless FM Modulator
- ◆ Last Position Memory for DVD
- ◆ Screen Mode Selection (16:9, 4:3)
- ◆ Full Function Remote Control
- ◆ Backlit Controls
- ◆ AV Output

CONTROLS AND INDICATORS DIAGRAM (FRONT VIEW)

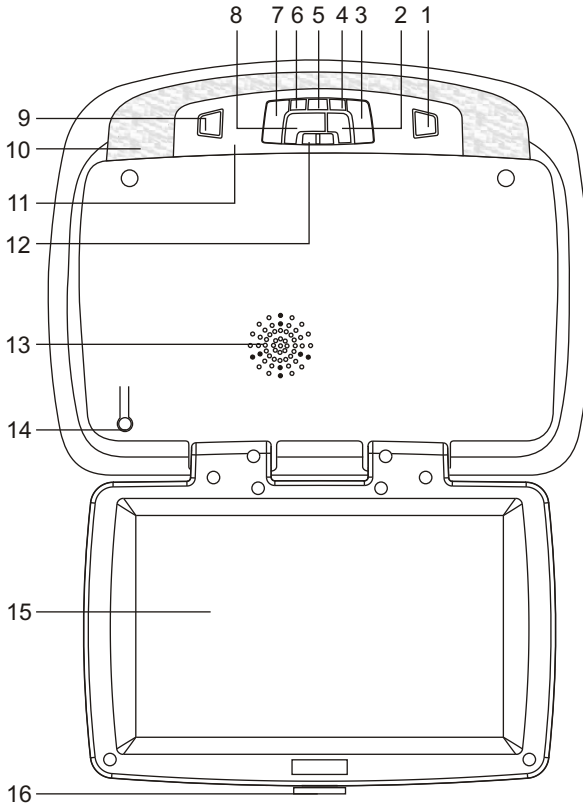

- 1. EJECT (▲) Button**
This Button is used for ejecting discs from the disc Compartment when the source is DVD and the unit is powered up.
- 2. STOP (■) Button**
This button is used to stop playback.
- 3. Source Select**
Use to select one of the four sources: DVD, AUX, AV1.
- 4. Picture Select (+)**
To increase the level of selected picture controls.
- 5. Picture Select Button**
Allows the user to enter the picture adjustment mode.

6. Picture Select (–)

To decrease the level of selected picture controls.

7. FMM Source Select Switch

Used to select the frequency in sequence rotation: FM OFF, CH1 88.1MHz, CH2 88.3MHz, CH3 88.5MHz, CH4 88.7MHz, CH5 88.9MHz, CH6 89.1MHz, CH7 89.3MHz, CH8 89.5MHz, CH9 89.7MHz, CH10 89.9MHz, CH11 90.1MHz, CH12 90.3MHz, CH13 90.5MHz, CH14 90.7MHz, CH15 90.9MHz, CH16 91.1MHz.

8. PLAY (▶) Button

This button is used to start playback of a disc.

9. POWER (⏻) Button

Used to turn the system on/off.

10. Dome Lights

Provide additional interior illumination.

11. Infrared Transmitter and Sensor

Transmits audio to wireless headphones. Also allows the remote control to operate the MMD11 A and to control other accessories in the system.

12. Three Position Dome Light Switch

ON – Turns on the dome lights.

OFF – The dome lights will not turn on in this position.

AUTO – Automatically switches on the dome lights in conjunction with the vehicle's interior illumination.

13. Ventilation Openings

14. LCD Cut Off Switch

Used to turn off the LCD panel monitor when in the closed position.

15. LCD Panel

16. Screen Release

Press to release the screen.

CONTROL FUNCTION DESCRIPTION (SIDE VIEW & BACK VIEW)

Side View

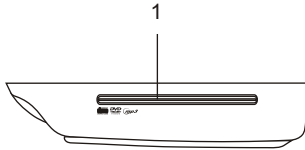

1. DVD Disc insertion Slot

For loading and removing discs. Unit must be in a powered on state to load disc when disc is inserted. Insert disc with label side facing up.

Back View

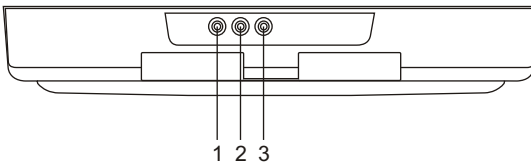

1. Auxiliary Video Input
2. Auxiliary Audio Left Input
3. Auxiliary Audio Right Input

REMOTE CONTROL OPERATION

Battery Installation

Before attempting to operate your Remote Control, install the batteries as described below.

- 1) Turn the Remote Control face down. Using your finger, slide the battery cover off in the direction of the arrow.
- 2) Install Two “AAA” batteries. Make sure that proper polarity (+ or -) is observed.
- 3) Align the cover tabs with the remote control and slide the cover until it locks.

The remote control will operate the MMD11 A. It is not a universal remote control and will not control equipment from other manufacturers.

Back View

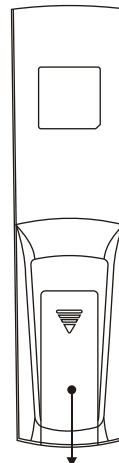

Battery Cover

MAIN FUNCTION DESCRIPTION

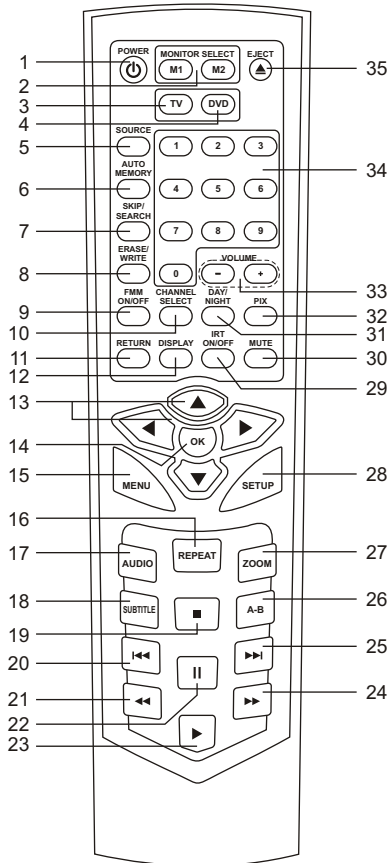

* Function control is available on the unit and the remote control.

** Function not available in this model.

1. POWER Button*

Press this button to turn the unit ON and OFF.

2. MONITOR SELECT

M1 Button – Sets the remote control code to allow control of the unit set to M1 mode only.

M2 Button – Invalid function for this model

3. TV Mode Select Button**

Switches certain function keys on the remote control for TV functions.

4. DVD Mode Select Button

Switches certain function keys on the remote control for DVD functions.

5. SOURCE Button*

Each time the button is pressed, the audio / video source will change in the following sequence: DVD > AUX > AV1.

6. AUTO MEMORY Button (AUTO PROGRAM Button)**

When the AUTO MEMORY button is pressed, all channels are searched and channels that are detected with signals of sufficient levels are automatically stored in memory.

7. SKIP / SEARCH Button**

This button selects between SKIP and SEARCH mode. In "SKIP mode" the TV tuner will tune and stop on channels that are programmed into memory when the CHANNEL UP / DOWN buttons are used. When the SKIP mode is disabled, the TV will stop on all active channels.

8. ERASE / WRITE Button**

While tuned to a channel, pressing this button will alternately store or erase the channel from memory.

9. FMM ON / OFF Button*

Turns the wireless FM Modulator on or off.

10. CHANNEL SELECT Button*

Selects the wireless FM Modulator Frequency (CH1 88.1MHz, CH2 88.3MHz, CH3 88.5MHz, CH4 88.7MHz, CH5 88.9MHz, CH6 89.1MHz, CH7 89.3MHz, CH8 89.5MHz, CH9 89.7MHz, CH10 89.9MHz, CH11 90.1MHz, CH12 90.3MHz, CH13 90.5MHz, CH14 90.7MHz, CH15 90.9MHz, CH16 91.1MHz)

11. RETURN Button

Press Return Once : Go to disc menu.

Press Return Twice : Go to movies playback.

12. DISPLAY

Press to display current disc information while the disc is playing. Press cursor (▲▼) buttons to select the Title or Chapter. For Title/Chapter selection use the numeric buttons to enter the desired Title Chapter selection.

13. CURSOR / CHANNEL UP DOWN (▲▼◀▶)**

Use these buttons to navigate the menu selections on the screen.

Use the CH▲ to increase the channel number and use CH▼ to decrease the channel number. **

14. OK Button (ENTER)

Used to implement a selected setting or menu option.

15. MENU Button

Allows the user to access the DVD menu(DVD MODE).

16. REPEAT Button

Allows the user to repeat a selected title, chapter, or track.

17. AUDIO Button

Press to display and select the available AUDIO languages in DVD mode. Each time you press the button, the language changes.

Note: *The languages for audio vary from disc to disc.*

18. SUBTITLE Button

Press to display and select the available subtitle language in DVD mode. Each time you press the button, the subtitle language changes.

Note: *The type and number of languages for subtitle vary from disc to disc.*

19. STOP (■) Button*

Press to stop playback.

20. PREVIOUS (⏮) Button

Press to return to the previous chapter or track.

21. SCAN BACKWARD (⏮) Button

Press to search in a backward direction. Press repeatedly to change the search speed from 2, 4, 8, and 16 times the normal speed.

22. PAUSE (||) Button

Allows the user to pause the playback. Pressing pause again or pressing the Play Button will resume normal playback.

23. PLAY Button*

Press to activate the play mode when a disc is loaded in the disc compartment.

24. SCAN FORWARD (⏭) Button

Press to search in a forward direction. Press repeatedly to change the search speed from 2, 4, 8, and 16 times the normal speed.

25. NEXT (⏭) Button

Press to skip to the next chapter or track.

26. A-B Button

Allow user to repeat the playback from point A to point B.

Press A-B button On-Screen Display DVD player

Once	Repeat A-	Mark the beginning of the section to repeat (Set point A)
Twice	Repeat AB	Mark the end of the section to repeat (Set point B)
3 times	AB Off	Cancel the A-B repeat function

27. ZOOM Button

Press this button to enlarge the picture when playing a DVD disc.

Press ZOOM button DVD player perform

Once	Enlarge the picture 1 times of the original size
Twice	Enlarge the picture 2 times of the original size
3 times	Enlarge the picture 3 times of the original size
4 times	Picture is returned to original size

28. SETUP Button

Press to display the Setup Menu which allows the user to change the DVD player options such as TV DISPLAY, OSD LANGUAGE, PARENTAL CONTROL etc. Refer to the settings and Adjustments section for more information.

29. IRT ON/OFF Button

Turns the Infrared Transmitter IRT ON or OFF for IR Wireless Headphones. Pressing M1 then IRT ON/OFF will control the IR Transmitter for M1.

30. MUTE Button

Press this button to mute all the audio.

Pressing the button again restores the sound to the previously set level.

31. DAY/ NIGHT Mode Button**

This control toggles the unit between "Day" and "Night" LCD illumination modes. In the "Day" mode, the LCD backlit intensity is at maximum. In "Night" mode, the LCD backlit is dimmed to a preset level that is more suitable for low light operation.

32. PIX Button (Picture Select)*

Each time this button is pressed, the on screen picture adjustment displays the "adjustment bar" for BRIGHTNESS, CONTRAST, COLOR, TINT or RESET. Once the desired adjustment bar is displayed, use the VOLUME(+)/ VOLUME(-) button to adjust the setting. The display will automatically turn off if no adjustments are made within 6 seconds, or is any other button is pressed.

33. VOLUME DOWN (-) or UP (+)*

Press to decrease or increase the level of the picture adjustments.

34. NUMBER Buttons

Allow the user to enter numbers 0 to 9 for selection of selection of CD tracks, DVD chapters and password.

35. EJECT (▲) Button*

This button is used to eject the disc.

MENU ADJUSTMENT

The System Menu Contains features and options that let you customize your system to change the screen mode display, OSD language and source default.

- 1.) Press the SYSTEM MENU button on the remote, the main page of the system menu will appear on screen.
- 2.) Use the cursor buttons ▲ or ▼ to select the desired item in the main page and press the OK button to select.
- 3.) The sub menu will appear on screen.
- 4.) Use the cursor buttons ▲ or ▼ to select an item in the sub menu and then press the OK button to select.
- 5.) Press the Menu button to exit System Menu.

Note: System Menu can be controlled via Remote Control only. (Items selected in the menu will have a green background)

SCREEN MODE SELECT

This allows the user to change the screen format (aspect ratio 16:9, 4:3).

- 1.) To select the screen aspect ratio format highlight SCREEN MODE and then press the OK button to enter the sub menu. Then use the cursor buttons ▲ or ▼ to select from either 4:3 or 16:9. Press the OK button to confirm the setting.



OSD LANGUAGE

This allows the user to select the language for the on-screen display. The user can either select English, Spanish, French or German for the OSD language.

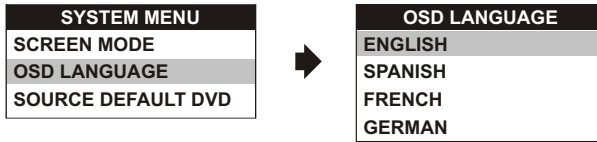

SOURCE DEFAULT DVD

This allows the user to select from:

DVD default on- Whenever the unit is turned on it will return to DVD mode.

DVD default off- Whenever the unit is turned on it will return to the last source selected.

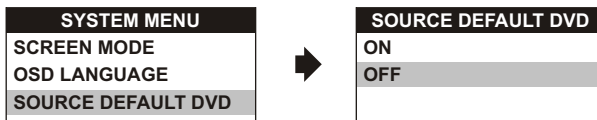

SETTINGS AND ADJUSTMENTS

The Setup Menu contains features and options that let you customize your DVD player. For example, you can set a language for the on-screen display or prevent DVD playback for children.

Using the Setup Menu

1. Press the SETUP button on the remote. The Setup Menu appears on the screen as shown per diagram.

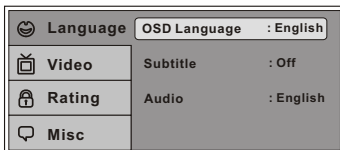

2. In order set the desired option, move the highlight into the setup area using the cursor button ►.
3. After entering the setup area, highlight the desired option using the cursor button ▲ or ▼.
4. Press ► to move the highlight to the different options for the selected item. Press ▲ or ▼ to select the desired options, and then press ENTER to confirm the selection.

- Repeat steps 3~4 to continue setting the options that reside on the same Setup Page.
- To change to another Setup page, press ◀ until the highlight moves back to the icon on the top part of the Setup Menu. Then, repeat steps 2~5.

Exiting the Setup Menu

Press the SETUP button again only.

LANGUAGE SETUP

Language for On-Screen Display

OSD MENU: The OSD MENU setup allows you to select the language for the on-screen display.

The user can either select English, French, Spanish, German or Italian for the OSD language.

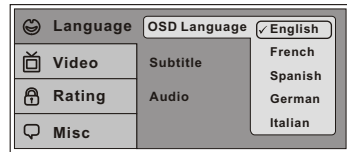

SUBTITLE SETUP

select "SUBTITLE" using ▲▼button, then press ►button to enter the Sudmenu. Select the subtitle you desire using ▲▼button, then press "OK" to confirm the setting. Press ◀button to return.

Note: The subtitle selection is only available for discs that are recorded in the above listed languages. If the selected language is not available, the player will play and display on the screen the original language contained in the disc.

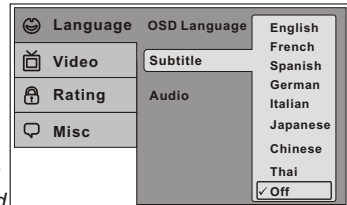

AUDIO SETUP

select "AUDIO" using ▲▼button, then press ►button to enter the Sudmenu. Select the audio you desire using ▲▼button, then press "OK" to confirm the setting. Press ◀button to return.

Note: The audio selection is only available for discs that are recorded in the above listed languages. If the selected language is not available, the player will play and display on the screen the original language contained in the disc.

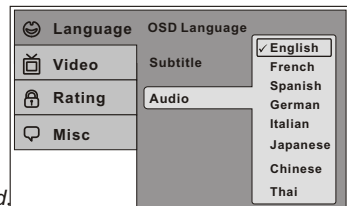

VIDEO SETUP

TV Display

The TV DISPLAY setup allows you to adjust screen setting (aspect ratio).

4:3 This displays the wide picture with black bands on the upper and lower portions of the screen.

16:9 This displays a wide picture with black bands on the upper and lower portion of the screen.

The bandwidth will vary, depending on the aspect ratio of the disc.

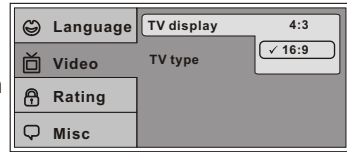

TV Type

The TV TYPE setup allows you to select the system to fit to the color system of the TV to be connected.

NTSC - Select this type for NTSC TV

PAL - Select this type for PAL TV

Multi - Select this type for multi-system TV

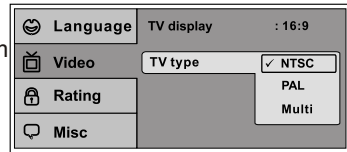

RATING SETUP

Rating

This item allows you to limit the content of movie playback from G to Adult. The lower the value, the more strict the control.

G

PG

PG – 13

R

NC – 17

Adult

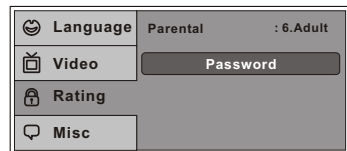

The rating level can only be changed when the displayed lock is open. For first time use to change parental control, using cursor ► button to enter parental mode, key in the default password (3308) and press OK. Press OK button again to select the parental level, select the level and press OK. To change the password to your own password press “Change Password” mode and enter the default password (3308) and press OK. Press OK button and again and key in a new four digit password. After complete press OK button to end the process.

Note: The Default Password is 3308. This password is always effective even after you have selected your own password and changed it. To avoid the possibility of others using the default password to set the parental level and change the password, you can record this default password in another area and delete it from this manual. Some discs can be limited depending on the age of users while some discs cannot.

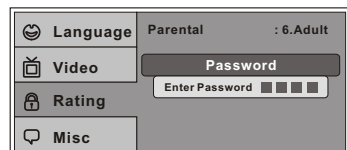

Misc SETUP

select "MISC" using ▲▼button, then press ►button to enter the Miscmenu. Select the subtitle you desire using ▲▼button, then press "ENTER" to confirm the setting. Press ◀button to return.

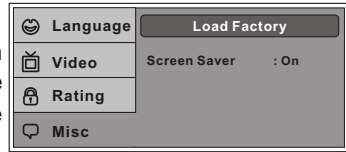

Load Factory

Load Factory allows you to reset all options to factory settings.

* This function will not affect the Rating control settings.

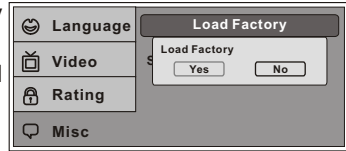

Screen Saver

ON -Screen saver will appear

OFF -Screen saver will not appear

Note: The DVD player will enable the Screen Saver mode if the unit is inactive for approximately 2 minutes.

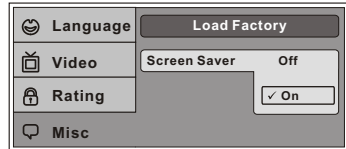

Playing DVDs

1. Press the DISPLAY button on the remote control to display the status banner. The banner includes title, chapter, angle, audio, subtitle, title selection & chapter selection.
2. **Title Selection**
Press numeric(0~9) buttons to initiate a change of title selection. Then press OK button to implement the selection.
3. **Chapter selection**
Press numeric(0~9) buttons to initiate a change of chapter selection. Then press OK button to implement the selection.

As you toggle through the options, the repeat option changes at that time. The track, for example, repeats once that track has ended. The selected repeat option loops repeatedly until you turn it off.

Playing MP3 Discs

MP3 is a format for storing digital audio. An audio CD-quality song can be compressed into the MP3 format with very little loss of quality, while taking up much less space. CD-R discs that have been encoded in MP3 format can be played on your DVD player. The DVD player plays the songs in the order they were burned on to the disc. When playback is started the elapsed time of the track that is playing will be displayed.

Selecting Folders and Songs

When a device containing MP3 files is loaded in the player, the navigation menu appears automatically.

1. Press ▲ or ▼ to move the highlight to the desired folder (if present) on the left side of the menu and press OK. The songs in the folder will be displayed on the screen.
2. Press ▲ or ▼ to move the highlight to the desired track containing the song and press OK to begin track playback.

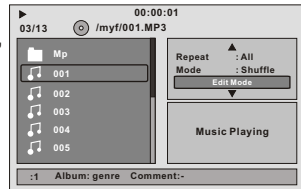

Skipping Songs

Use the Next (▶▶) button on the remote control to move to the next song. Use the Previous (◀◀) button to move to the previous song.

Selecting a Play Mode

Filter (For MP3 & JPEG only)

Filter Mode enables or disables the display of files contained on the media based on their file extension.

The Filter function applies th the following formats:

- Audio** - Audio data format (MP3, WMA)
- Photo** - Photo data format (JPEG)
- Video** - Video data format (MPEG I, II)

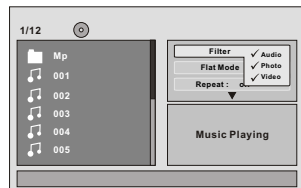

Flat Mode: play the entire disc

This mode is always on (default). During the Flat Mode all the data folders with Mp3, JPEG & movies will be played in sequence. If the Flat Mode function is off, it will only play the selected folder; other folders are disabled.

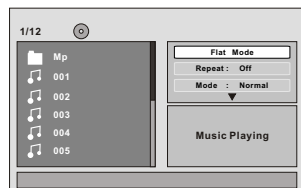

Repeat: play repetitively

Repeat function has 4 options: Off, Single, Folder, All. Move cursor to Repeat function and press OK, Off/Single/Folder/All are displayed in that order. Repeat default is Off;

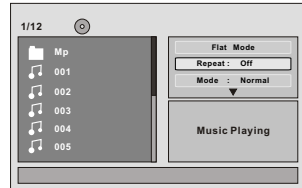

- Off** Turn of repeat function
- Single** Repeat the song being played until STOP is pressed.
- Folder** Play all songs in a folder repetitively
- All** Play all songs on the disc repetitively

Mode: play mode

The Mode function has 4 options: Normal, Shuffle, Random and Music Intro. Move cursor to the desired Mode function and press OK; Normal/Shuffle/Random/Music Intro are selected in that order. The Mode function default status is Normal.

- Normal:** Play all songs in folder once
- Shuffle:** Play songs in a folder in a shuffled order. Each song in the folder is played only once.
- Random:** Play songs in a folder in a random order. Each song in the folder is played only once.
- Music Intor:** Play each song in order in the folder for 10 seconds

Remark-- The purpose of the Music Intro function is to provide the user with a sample of each song for 10 seconds, thereby making it easy to select and listen to a favorite song.

Edit Mode

Program View

Add to Program

Notice: Edit Mode/Program view/Add to program functions are all related and can not be implemented during play mode or any other program function.

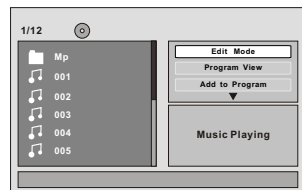

Method: Make sure disc playback is off. Move cursor to Edit Mode function and press OK. After Edit Mode is selected, open the folder and select the songs which will be compiled. A check mark appears to the left of the selected song; highlight the Add to program function and press OK. The selected song is added to a new program and the check mark disappears; move cursor to program view function and press OK to browse the songs in the program.

In Edit Mode, if Add to program function is used, highlight Program view function and press OK; the following selections appear:

Edit Mode
Browser View
Clear Program



Method: When Add to program function is finished, highlight the Browser view function; the songs in the new program are displayed. To delete a selected song, highlight the selected song; a check mark appears to the left of the selected song. Highlight Clear program function and press OK; the song will be deleted.

DVD Basics

To get the optimum use out of the DVD section, make sure you read this section completely.

Regional Coding

Both the DVD player and DVDs are coded by region. These regional codes must match in order for the disc to play. If the codes don't match, the disc won't play. This unit's code is region 1. Other regional codes cannot be played in this unit. The unit will display "WRONG REGION".

Types of Discs your DVD will play

- DVD* disc - DVD discs which contain video.
 - Audio discs - Audio CDs contain musical or sound content only.
 - MP3 discs - A disc that contains audio files (for example, a CD-R with downloaded MP3 files).
- * This system is capable of playing most recordable DVD formats. However, due to the variety of disc manufacturers and software, playback cannot be guaranteed.

Loading and Playing Discs

Before you load a disc, make sure that it is compatible with the player. Insert the disc with the label facing the driver.

Note: the following Discs **CANNOT** be used with this player :

- MiniDisc
- Laserdisc
- CD-1, CD-ROM, DVD-ROM, Super Audio CD (SACD), DVD Audio, JPEG (KODAK)

To load and Play a Disc

Press the Power button to turn the unit ON. Select DVD mode and insert the disc (Label towards driver) into the disc compartment.

TURNING THE UNIT ON OR OFF

1. Pushing in the Screen Release button will unlock the LCD screen and it will drop down slightly. Pivot the screen downward until a comfortable viewing angle is reached. The hinge friction will hold the screen in position while the system is in use.
2. Pressing the power button* on the unit or the remote control will turn the system on and off. When in use the internal backlighting will illuminate the controls.
3. After the unit has been turned on and is displaying a picture, adjust the viewing angle, by pivoting the screen to optimize the picture quality.
4. Remember to turn the unit off and pivot the LCD to the locked position when not in use.

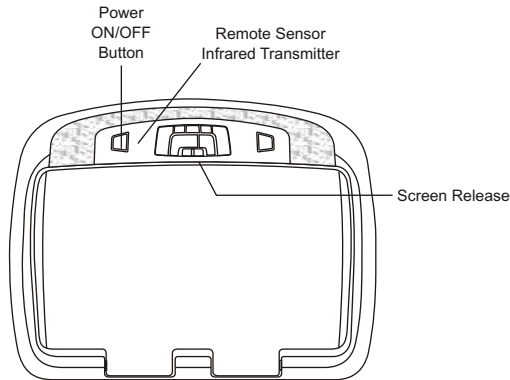

OVERHEAD DOME LIGHTS

The Dome Lights integrated into the MMD11 A are controlled by a three position slide switch. Sliding the switch to the ON position will turn the lights ON. The OFF position will prevent the lights from turning ON with the vehicle's interior lighting, and the auto position will allow the lights to turn ON and OFF with the vehicle's interior lighting. Refer to the Installation Guide for wire connections. Do not leave the vehicle unattended with the dome light switch in the ON position, as this could result in a discharged battery.

REMOTE SENSOR

The MMD11 A infrared remote sensors to relay signals to the unit when the remote control is pointed at the remote sensor.

ACCESSORIES

WIRELESS HEADPHONES (OPTIONAL)

The MMD11 A includes a built-in infrared transmitter for use with the supplied wireless headphones. The headphone volume is adjusted using the controls on each headset. Any number of wireless headphones may be used but they must be used within a line of sight from the transmitter, as infrared transmissions, like visible light travel only in a straight line. See the documentation accompanying your wireless headphones.

SOURCE FEATURE

AV1

The video input may be connected to a Video Cassette Player (VCP), video game system, or other audio / video devices. To access the A/V inputs, turn the MMD11 A on and press the source button on the MMD11 A or the Source button on the remote control until "AV1" is displayed on the screen. Turn the video source component on with its power button or remote control. The MMD11 A is now ready to play the audio and video signals from the source connected to AV1 input (use accessory cable part number 11236820 required).

AUX

The MMD11 A will accept an audio / video input through the 3 RCA jacks located on the rear of the unit. The audio / video device could be a video game system, video camera, or other input device.

Video Out

The MMD11 A provides a video output for optional audio/video monitor(s). This output will provide an audio/video signal that duplicates the signal displayed by the MMD11 A to an additional monitor or video display. Please see your installer for more information.

TROUBLESHOOTING

PROBLEM	SOLUTION
IR remote inoperative	<ul style="list-style-type: none"> • Verify that the batteries in the remote are fresh. • Verify that the remote sensor eye is not obstructed.
Disc won't play	<ul style="list-style-type: none"> • Insert a disc with the label side facing up. • Check the type of disc you put into disc tray. This DVD only plays DVDs, audio CDs and MP3s. • Both the unit and the disc are coded by region. If the regional codes don't match, the disc can't be played. This DVD player is set to Region Number 1.
Play starts, but then stops immediately	<ul style="list-style-type: none"> • The disc is dirty. Clean it. • Condensation has formed. Allow player to dry out.
No sound or distorted sound	<ul style="list-style-type: none"> • Make sure your DVD is connected properly. Make sure all cables are securely inserted into the appropriate jacks. • If you are using the 2-channel IR headphones, make sure you turn on the IR headphone power, make sure the correct channel (A-B) is selected. • Make sure the Modulator is ON and the proper Frequency has been selected.
Can't advance through a movie	<ul style="list-style-type: none"> • You can't advance through the opening credits and warning information that appears at the beginning of movies because the disc is programmed to prohibit that action.
⊘ Not allowed at the moment	<ul style="list-style-type: none"> • The feature or action cannot be completed at this time because: <ol style="list-style-type: none"> 1. The disc's software restricts it. 2. The disc's software doesn't support the feature (e.g., angles) 3. The feature is not available at the moment.
Picture is distorted	<ul style="list-style-type: none"> • The disc might be damaged. Try another disc. • It is normal for some distortion to appear during forward or reverse scan.
No forward or reverse scan	<ul style="list-style-type: none"> • Some discs have sections that prohibit rapid scanning or title and chapter skip. • If you try to skip through the warning information and credits at the beginning of a movie, you won't be able to. This part of the movie is often programmed to prohibit skipping through it.

REPLACEMENT PARTS

Remote Control 136-4196

SPECIFICATIONS

LCD Backlighting	Edge Light Tube
Resolution	800 x RGB x 480
Pixels	1, 152, 000
Operation Temperature	32 ~131° F (0 ~ 55° C)
Storage Temperature	-4 ~ 158° F (-20 ~ 70° C)
Backlit life	15,000 Hours
Video Display System	NTSC / PAL
Video Output	1.0Vp-p @ 75 ohms
Power Source	12V DC
Dimension	L x W x H 14.0" x 12.0" x 2.0" 356mm x 305mm x 60mm

Specifications subject to change without notice.



12 MONTH LIMITED WARRANTY

Applies to Movies To Go Mobile Video Products

AUDIOVOX ELECTRONICS CORP. (the Company) warrants to the original retail purchaser of this product that should this product or any part thereof, under normal use and conditions, be proven defective in material or workmanship within 12 months from the date of original purchase, such defect(s) will be repaired or replaced with reconditioned product (at the Company's option) without charge for parts and repair labor. A game controller, if supplied, is similarly warranted for ninety (90) days.

To obtain repair or replacement within the terms of this Warranty, the product is to be delivered with proof of warranty coverage (e.g. dated bill of sale), specification of defect(s), transportation prepaid, to the Company at the address shown below.

This Warranty does not extend to the elimination of externally generated static or noise, to correction of antenna problems, to costs incurred for installation, removal or reinstallation of the product, or to damage to digital memory/media devices, gaming devices, discs, speakers, accessories, or vehicle electrical systems.

This Warranty does not apply to any product or part thereof which, in the opinion of the Company, has suffered or been damaged through alteration, improper installation, mishandling, misuse, neglect, accident, or by removal or defacement of the factory serial number/bar code label(s). THE EXTENT OF THE COMPANY'S LIABILITY UNDER THIS WARRANTY IS LIMITED TO THE REPAIR OR REPLACEMENT PROVIDED ABOVE AND, IN NO EVENT, SHALL THE COMPANY'S LIABILITY EXCEED THE PURCHASE PRICE PAID BY PURCHASER FOR THE PRODUCT.

This Warranty is in lieu of all other express warranties or liabilities. ANY IMPLIED WARRANTIES, INCLUDING ANY IMPLIED WARRANTY OF MERCHANTABILITY, SHALL BE LIMITED TO THE DURATION OF THIS WRITTEN WARRANTY. ANY ACTION FOR BREACH OF ANY WARRANTY HEREUNDER INCLUDING ANY IMPLIED WARRANTY OF MERCHANTABILITY MUST BE BROUGHT WITHIN A PERIOD OF 24 MONTHS FROM DATE OF ORIGINAL PURCHASE. IN NO CASE SHALL THE COMPANY BE LIABLE FOR ANY CONSEQUENTIAL OR INCIDENTAL DAMAGES FOR BREACH OF THIS OR ANY OTHER WARRANTY. No person or representative is authorized to assume for the Company any liability other than expressed herein in connection with the sale of this product.

Audiovox Electronics Corporation,
150 Marcus Blvd., Hauppauge, New York 11788 | 1-800-645-4994

128-6429F

Free Manuals Download Website

<http://myh66.com>

<http://usermanuals.us>

<http://www.somanuals.com>

<http://www.4manuals.cc>

<http://www.manual-lib.com>

<http://www.404manual.com>

<http://www.luxmanual.com>

<http://aubethermostatmanual.com>

Golf course search by state

<http://golfingnear.com>

Email search by domain

<http://emailbydomain.com>

Auto manuals search

<http://auto.somanuals.com>

TV manuals search

<http://tv.somanuals.com>