



SERVICE MANUAL

VHF TRANSCEIVER

IC-F110S
IC-F111S
IC-F121S

INTRODUCTION

This service manual describes the latest service information for the **IC-F110S, IC-F111S and IC-F121S** VHF MOBILE TRANSCEIVER at the time of publication.

MODEL	VERSION	SYMBOL
IC-F110S	Europe	EUR
	General	GEN
IC-F111S	General	GEN
IC-F121S	U.S.A.	USA

To upgrade quality, any electrical or mechanical parts and internal circuits are subject to change without notice or obligation.

DANGER

NEVER connect the transceiver to an AC outlet or to a DC power supply that uses more than 16 V. This will ruin the transceiver.

DO NOT expose the transceiver to rain, snow or any liquids.

DO NOT reverse the polarities of the power supply when connecting the transceiver.

DO NOT apply an RF signal of more than 20 dBm (100 mW) to the antenna connector. This could damage the transceiver's front end.



ORDERING PARTS

Be sure to include the following four points when ordering replacement parts:

1. 10-digit order numbers
2. Component part number and name
3. Equipment model name and unit name
4. Quantity required

<SAMPLE ORDER>

1110003490 S.IC TA31136FN IC-F110S MAIN UNIT 5 pieces
8810009990 Screw PH BT M3×8 ZK IC-F110S Bottom cover 10 pieces

Addresses are provided on the inside back cover for your convenience.

REPAIR NOTES

1. Make sure a problem is internal before disassembling the transceiver.
2. **DO NOT** open the transceiver until the transceiver is disconnected from its power source.
3. **DO NOT** force any of the variable components. Turn them slowly and smoothly.
4. **DO NOT** short any circuits or electronic parts. An insulated tuning tool **MUST** be used for all adjustments.
5. **DO NOT** keep power ON for a long time when the transceiver is defective.
6. **DO NOT** transmit power into a signal generator or a sweep generator.
7. **ALWAYS** connect a 40 dB to 50 dB attenuator between the transceiver and a deviation meter or spectrum analyzer when using such test equipment.
8. **READ** the instructions of test equipment thoroughly before connecting equipment to the transceiver.

EXPLICIT DEFINITIONS

FREQUENCY COVERAGE

136 – 174 MHz

CHANNEL SPACING

	12.5 kHz/ 25.0 kHz
Narrow/Wide-type	15.0 kHz/ 30.0 kHz
Narrow/Middle-type	15.0 kHz/ 20.0 kHz

TABLE OF CONTENTS

SECTION 1	SPECIFICATIONS	
SECTION 2	INSIDE VIEW	
SECTION 3	DISASSEMBLY INSTRUCTIONS	
SECTION 4	CIRCUIT DESCRIPTION	
4 - 1	RECEIVER CIRCUITS	4 - 1
4 - 2	TRANSMITTER CIRCUITS	4 - 2
4 - 3	PLL CIRCUITS	4 - 3
4 - 4	POWER SUPPLY CIRCUITS	4 - 4
4 - 5	PORT ALLOCATIONS	4 - 4
SECTION 5	ADJUSTMENT PROCEDURES	
5 - 1	PREPARATION	5 - 1
5 - 2	PLL ADJUSTMENT	5 - 4
5 - 3	SOFTWARE ADJUSTMENT	5 - 5
5 - 4	TRIMMER ADJUSTMENT	5 - 7
SECTION 6	PARTS LIST	
SECTION 7	MECHANICAL PARTS	
SECTION 8	SEMI-CONDUCTOR INFORMATION	
SECTION 9	BOARD LAYOUTS	
9 - 1	FRONT UNIT	9 - 1
9 - 2	MAIN UNIT	9 - 3
SECTION 10	BLOCK DIAGRAM	
SECTION 11	VOLTAGE DIAGRAMS	
11 - 1	FRONT UNIT	11 - 1
11 - 2	MAIN UNIT	11 - 2

SECTION 1 SPECIFICATIONS

		[GEN], [USA]	[EUR]
GENERAL	Measurement method	EIA-152-C/204D or TIA-603	EN 300 086
	Frequency coverage	136.000–174.000 MHz	
	Type of emission	N/W: (12.5 kHz; Narrow/25 kHz; Wide): 8K50F3E/16K0F3E (12.5 kHz; Narrow/25 kHz; Wide): 11K0F3E/16K0F3E (15 kHz; Narrow/30 kHz; Wide): 11K0F3E/16K0F3E N/M: (12.5 kHz; Narrow/20 kHz; Middle): 8K50F3E/14K0F3E	[EUR] [GEN] [USA] [EUR]
	Number of conventional channels	Free: 8 channels, Bank: 4 channels × 2 banks	
	Antenna impedance	50 Ω nominal (SO-293)	
	Power supply voltage (negative ground)	13.2 V DC nominal 13.6 V DC nominal	[25 W] [50 W]
	Current drain (approx.)	TX: 7.0 A(at 25 W), 14.0 A(at 50 W) RX: 1200 mA(max. audio) 300 mA(stand-by)	
	Usable temperature range	–30°C to +60°C (–22°F to +140°F)	–25°C to +55°C (–13°F to +131°F)
	Dimensions (proj. not included)	150(W) × 40(H) × 117.5(D) mm; 5 ²⁹ / ₃₂ (W) × 1 ⁹ / ₁₆ (H) × 4 ⁵ / ₈ (D) inch 150(W) × 40(H) × 167.5(D) mm; 5 ²⁹ / ₃₂ (W) × 1 ⁹ / ₁₆ (H) × 4 ¹⁹ / ₃₂ (D) inch	[25 W] [50 W]
	Weight	0.8 kg; 1 lb 12 oz [25 W], 1.1 kg; 2 lb 7 oz [50 W]	
TRANSMITTER	RF output power	High/Low2/Low1: 25 W/10 W/2.5 W 50 W/25 W/5 W	[25 W] [50 W]
	Modulation system	Variable reactance frequency modulation	
	Maximum permissible deviation	±2.5 kHz [Narrow], ±4.0 kHz [Middle], ±5.0 kHz [Wide]	
	Frequency error	±5.0 ppm	±1.5 kHz
	Spurious emissions	70 dBc typical	0.25 μW ≤ 1GHz, 1.0 μW > 1 GHz
	Adjacent channel power	60 dB [Narrow], 70 dB [Middle], [Wide]	
	Audio frequency response	+2 dB to –8 dB of 6 dB/octave range from 300 Hz to 2550 Hz [Narrow]/3000 Hz [Middle], [Wide]	
	Audio harmonic distortion	3% typical at 1 kHz, 40% deviation	
	FM hum and noise (typical) (without CCICT filter)	40 dB [Narrow], 46 dB [Wide]	—
	Residual modulation (typical) (with CCICT filter)	—	50 dB [Narrow], 53 dB [Middle] 55 dB [Wide]
	Limiting charact of modulator	70–100% of max. deviation	
	Microphone connector	8-pin modular (600 Ω)	
RECEIVER	Receive system	Double-conversion superheterodyne system	
	Intermediate frequencies	1st: 46.35 MHz, 2nd: 450 kHz	
	Sensitivity (typical)	0.25 μV at 12 dB SINAD	–4 dBμV (emf) at 20 dB SINAD
	Squelch sencitivity (at threshold) (typical)	0.25 μV	–4 dBμV (emf)
	Adjcent channel selectivity (typical)	65 dB [Narrow], 75 dB [Middle]/[Wide]	
	Spurious response	75 dB	
	Intermodulation (typical)	74 dB	67 dB
	Hum and noise (typical)	(without CCITT filter) (with CCITT filter)	40 dB [Narrow], 45 dB [Wide] — 50 dB [Narrow], 53 dB [Middle], 55 dB [Wide]
	Audio output power	4 W typical at 10% distortion with a 4 Ω load	
	External SP connector	2-conductor 3.5 (d) mm (1/8")/4 Ω	

All stated specifications are subject to change without notice or obligation.

SECTION 2 INSIDE VIEW

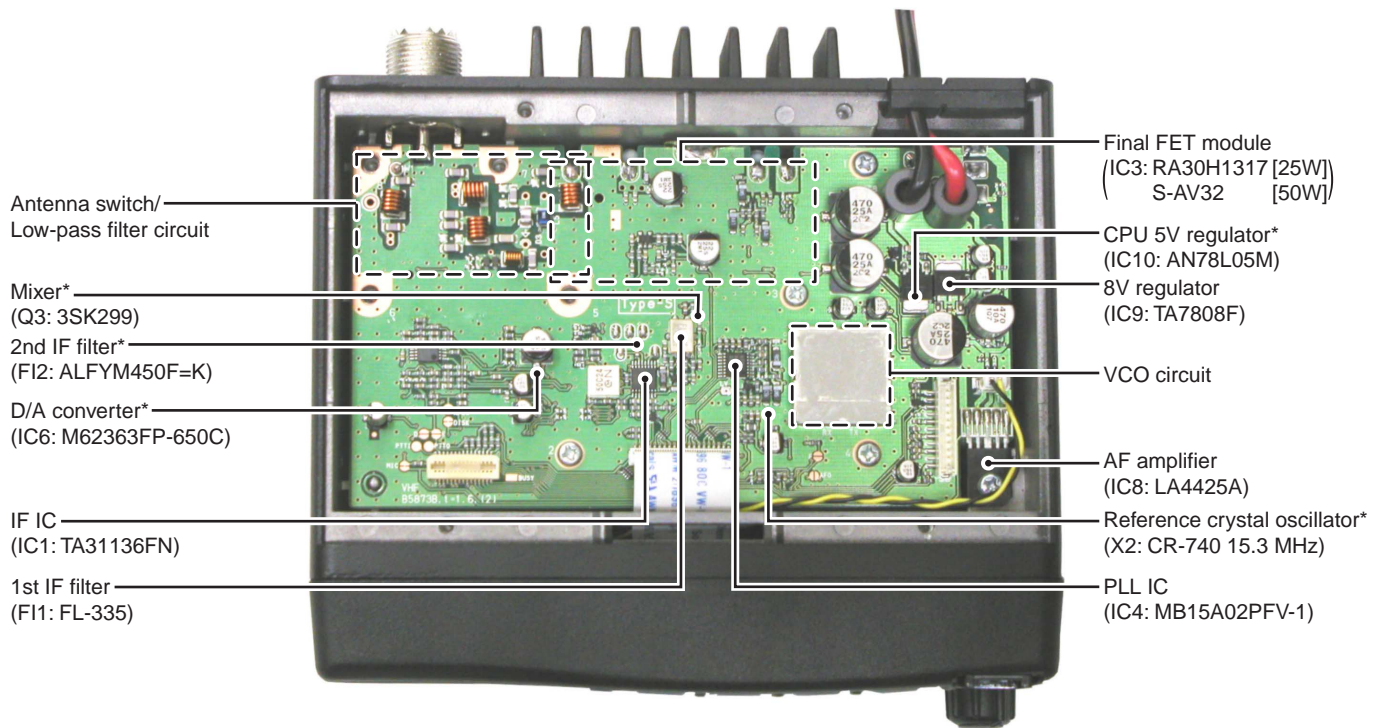

SECTION 3 DISASSEMBLY INSTRUCTIONS

• Opening case and remove the front panel

- ① Unscrew 4 screws (A), and remove the bottom cover.
- ② Disconnect the flat cable (B) from J2.
- ③ Disconnect the cable (C) from J7.
- ④ Unscrew 2 screws (D), and remove the front unit in the direction of the arrow.

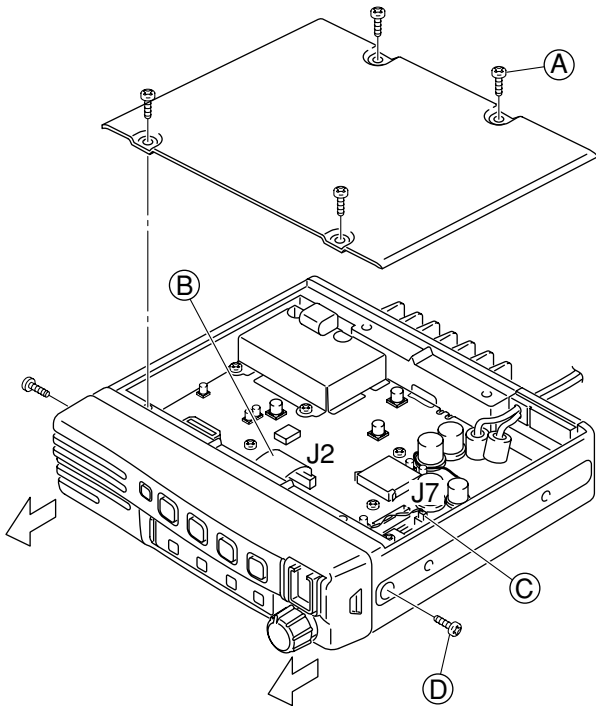

• Removing the main unit

- ① Unscrew 8 screws (E).
- ② Remove the filter case (F).
- ③ Unscrew the screw (G).
- ④ Unsolder 3 points (H) from the antenna connector.
- ⑤ Unsolder 4 points (I) from IC3.

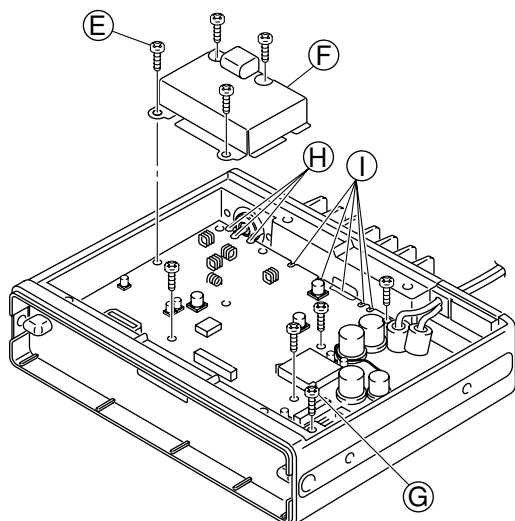

- ⑥ Lift up the front portion of the main unit and remove it.

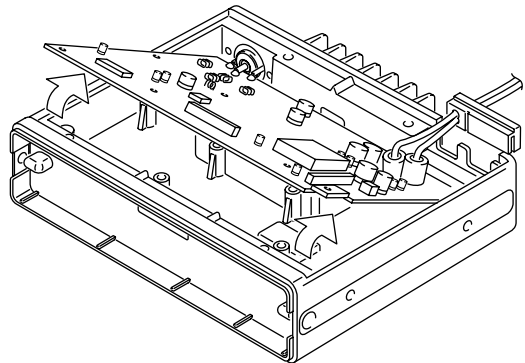

• Installation location

- | | |
|---------|--|
| UT-108 | DTMF decoder unit |
| UT-109 | Voice scrambler unit |
| UT-110 | |
| OPC-617 | ACC cable (for external terminal connection) |

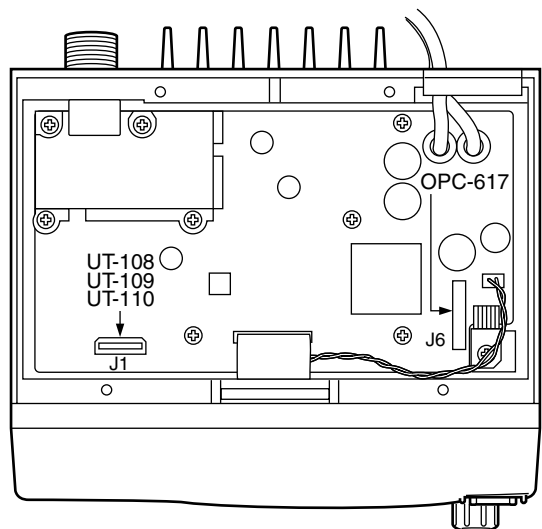

SECTION 4 CIRCUIT DESCRIPTION

4-1 RECEIVER CIRCUITS

4-1-1 ANTENNA SWITCHING CIRCUIT (MAIN UNIT)

The antenna switching circuit functions as a low-pass filter while receiving and as resonator circuit while transmitting. This circuit does not allow transmit signals to enter the receiver circuits.

Received signals enter the antenna connector and pass through the low-pass filter (L1–L3, C1, C2, C6–C8). The filtered signals are then applied to the RF circuit passed through the $\lambda/4$ type antenna switching circuit (D5, D6, D41, L6).

4-1-2 RF CIRCUIT (MAIN UNIT)

The RF circuit amplifies signals within the range of frequency coverage and filters out-of-band signals.

The signals from the antenna switching circuit pass through the two-stage tunable bandpass filters (D8, D4). The filtered signals are amplified at the RF amplifier (Q2) and then enter other two-stage bandpass filters (D9, D10) to suppress unwanted signals. The filtered signals are applied to the 1st mixer circuit (Q3).

The tunable bandpass filters (D4, D8–D10) employ varactor diodes to tune the center frequency of the RF passband for wide bandwidth receiving and good image rejection. These diodes are controlled by the CPU (FRONT unit; IC1) via the D/A converter (IC6).

The gate control circuit reduces RF amplifier gain and attenuates RF signal to keep the audio output at a constant level.

The receiver gain is determined by the voltage on the "RSSI" line from the FM IF IC (IC1, pin 12). The gate control circuit (Q1) supplies control voltage to the RF amplifier (Q2) and sets the receiver gain.

When receiving strong signals, the "RSSI" voltage increases and the gate control voltage decreases. As the gate control voltage is used for the bias voltage of the RF amplifier (Q2), then the RF amplifier gain is decreased.

• 2nd IF and demodulator circuits

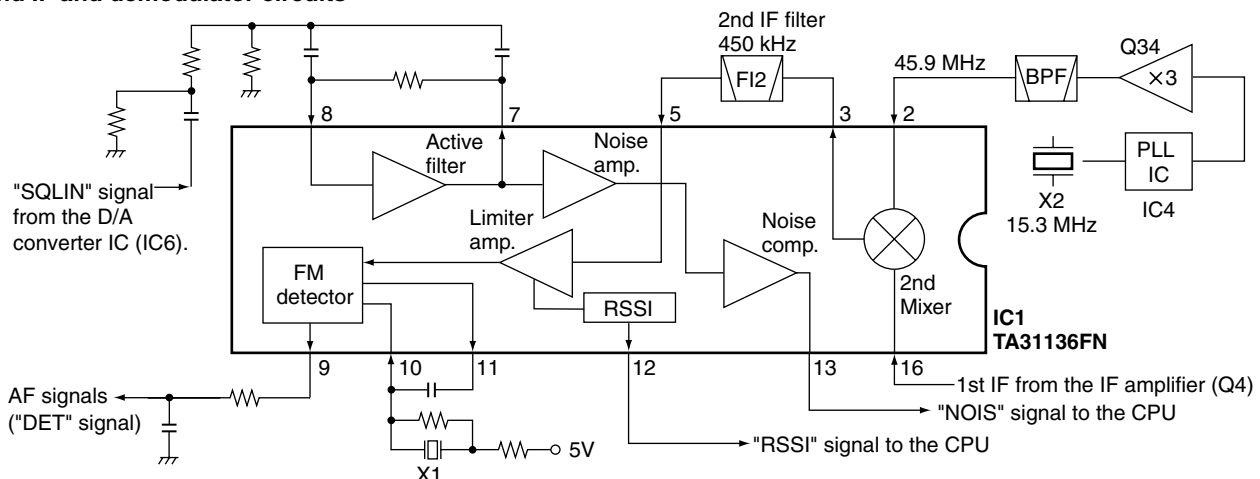

4-1-3 1ST MIXER AND 1ST IF CIRCUITS (MAIN UNIT)

The 1st mixer circuit converts the received signals to a fixed frequency of the 1st IF signal with the PLL output frequency. By changing the PLL frequency, only the desired frequency will pass through a MCF (Monolithic Crystal Filter; F11) at the next stage of the 1st mixer.

The RF signals from the bandpass filter are applied to the 1st mixer circuit (Q3). The applied signals are mixed with the 1st LO signal coming from the RX VCO circuit (Q14) to produce a 46.35 MHz 1st IF signal. The 1st IF signal passes through a MCF (Monolithic Crystal Filter; F11) to suppress out-of-band signals. The filtered signal is amplified at the 1st IF amplifier (Q4) and applied to the 2nd IF circuit.

4-1-4 2ND IF AND DEMODULATOR CIRCUITS (MAIN UNIT)

The 2nd mixer circuit converts the 1st IF signal to a 2nd IF signal. A double-conversion superheterodyne system improves the image rejection ratio and obtains stable receiver gain.

The 1st IF signal from the 1st IF amplifier (Q4) is applied to the 2nd mixer section of the FM IF IC (IC1, pin 16) and is then mixed with the 2nd LO signal for conversion to a 450 kHz 2nd IF signal.

IC1 contains the 2nd mixer, limiter amplifier, quadrature detector, active filter and noise amplifier circuits, etc. A tripled frequency from the PLL reference oscillator is used for the 2nd LO signal (45.9 MHz).

The 2nd IF signal from the 2nd mixer (IC1, pin 3) passes through a ceramic filter (F12) to remove unwanted heterodyned frequencies. It is then amplified at the limiter amplifier section (IC1, pin 5) and applied to the quadrature detector section (IC1, pins 10, 11 and X1) to demodulate the 2nd IF signal into AF signals.

The AF signals are output from pin 9 (IC1) and are then applied to the AF amplifier circuit.

4-1-5 AF AMPLIFIER CIRCUIT (MAIN UNIT)

The AF amplifier circuit amplifies the demodulated AF signals to drive a speaker.

The AF signals from the FM IF IC (IC1, pin 9) are applied to the active filter circuit (IC16). The active filter circuit (high-pass filter) removes CTCSS or DTCS signals.

The filtered AF signals are output from pin 14 (IC16) and are applied to the de-emphasis circuit (R117, C363) with frequency characteristics of -6 dB/octave, and then passed through the analog switch (IC14, pins 1, 2) and low-pass filter (IC5 pins 1, 2). The filtered signal is applied to the electronic volume controller (IC6, pin 9).

The output AF signals from the electronic volume controller (IC6, pin 10) are passed through the analog switch (IC14 pins 10, 11) and are applied to the AF pre-amplifier (IC15) and AF power amplifier (IC8) to drive the speaker.

4-1-6 RECEIVER MUTE CIRCUITS (MAIN AND FRONT UNITS)

• NOISE SQUELCH

The noise squelch circuit cuts out AF signals when no RF signals are received. By detecting noise components in the AF signals, the squelch circuit switches the AF mute switch.

Some noise components in the AF signals from the FM IF IC (IC1, pin 9) are passed through the level controller (IC6, pins 1, 2). The level controlled signals are applied to the active filter section in the FM IF IC (IC1, pin 8) as "SQLIN" signal. Noise components about 10 kHz are amplified and output from pin 7.

The filtered signals are converted to the pulse-type signals at the noise detector section and output from pin 13 (NOIS).

The "NOIS" signal from the FM IF IC is applied to the CPU (FRONT unit; IC1, pin 53). The CPU then analyzes the noise condition and controls the AF mute signal via "AFON" line (FRONT unit; IC1, pin 43) to the AF regulator (Q35, Q36, D29, D30).

• CTCSS AND DTCS

The tone squelch circuit detects AF signals and opens the squelch only when receiving a signal containing a matching subaudible tone (CTCSS or DTCS). When tone squelch is in use, and a signal with a mismatched or no subaudible tone is received, the tone squelch circuit mutes the AF signals even when noise squelch is open.

A portion of the AF signals from the FM IF IC (IC1, pin 9) passes through the low-pass filter (IC16) to remove AF (voice) signals and is applied to the CTCSS or DTCS decoder inside the CPU (FRONT unit; IC1, pin 50) via the "CDEC" line to control the AF mute switch.

4-2 TRANSMITTER CIRCUITS

4-2-1 MICROPHONE AMPLIFIER CIRCUIT (MAIN AND FRONT UNITS)

The microphone amplifier circuit amplifies audio signals within $+6$ dB/octave pre-emphasis characteristics from the microphone to a level needed for the modulation circuit.

The AF signals (MIC) from the MIC jack (FRONT unit; J1) are amplified at the AF amplifier (FRONT unit; IC5) and applied to the MAIN unit via J2 (pin 13). The AF signal are applied to the limiter amplifier (IC5, pin 5).

The entered signals are pre-emphasized with $+6$ dB/octave at a limiter amplifier, then passed through the analog switch (IC14, pins 4, 3) and splatter filter (IC5, pins 2, 1). The output signals from the splatter filter are applied to the level controller (IC6, pins 9, 10).

The deviation level controlled signals are then applied to the modulation circuit (D18) as the "MOD" signal after being passed through the analog switch (IC14, pins 9, 8).

4-2-2 MODULATION CIRCUIT (MAIN UNIT)

The modulation circuit modulates the VCO oscillating signal (RF signal) using the microphone audio signals.

The AF signals from the analog switch (IC14, pin 8) change the reactance of varactor diode (D18) to modulate the oscillated signal at the TX VCO circuit (Q13, D16, D31). The modulated VCO signal is amplified at the buffer amplifiers (Q11, Q10) and is then applied to the drive amplifier circuit via the T/R switch (D14).

The CTCSS/DTCS signals from the CPU (FRONT unit; IC1, pins 13, 14, 19, 20) are passed through the low-pass filter (FRONT unit; IC5), and mixer and splatter filter (IC5), and are then applied to the VCO circuit.

4-2-3 DRIVE AMPLIFIER CIRCUIT (MAIN UNIT)

The drive amplifier circuit amplifies the VCO oscillating signal to the level needed at the power amplifier.

The RF signal from the buffer amplifier (Q10) passes through the T/R switch (D14) and is amplified at the drive amplifier circuit (Q8). The amplified signal is applied to the power amplifier circuit.

4-2-4 POWER AMPLIFIER CIRCUIT (MAIN UNIT)

The power amplifier circuit amplifies the driver signal to an output power level.

The RF signal from the drive amplifier (Q8) is passed through the low-pass filter circuit (L18, C90, C89) and applied to the power module (IC3) to obtain 25 W or 50 W of RF power.

The amplified signal is passed through the antenna switching circuit (D2, D3), low-pass filter and APC detector, and is then applied to the antenna connector.

Control voltage for the power amplifier (IC3, pin 2) comes from the APC amplifier (IC2) to stabilize the output power. The transmit mute switch (D28) controls the APC amplifier when transmit mute is necessary.

4-2-5 APC CIRCUIT (MAIN UNIT)

The APC circuit protects the power amplifier from a mismatched output load and stabilizes the output power.

The APC detector circuit detects forward signals and reflection signals at D1 and D11 respectively. The combined voltage is at minimum level when the antenna impedance is matched at 50 Ω, and is increased when it is mismatched.

The detected voltage is applied to the APC amplifier (IC2, pin 3), and the power setting "T2" signal from the D/A converter (IC6, pin 22), controlled by the CPU (FRONT unit; IC1), is applied to the other input for reference. When antenna impedance is mismatched, the detected voltage exceeds the power setting voltage. Then the output voltage of the APC amplifier (IC2, pin 4) controls the input current of the drive amplifier (Q8) and power module (IC3) to reduce the output power.

4-3 PLL CIRCUITS

4-3-1 PLL CIRCUIT (MAIN UNIT)

A PLL circuit provides stable oscillation of the transmit frequency and receive 1st LO frequency. The PLL output compares the phase of the divided VCO frequency to the reference frequency. The PLL output frequency is controlled by the divided ratio (N-data) of a programmable divider.

The PLL circuit contains the TX/RX VCO circuit (Q13, Q14). The oscillated signal is amplified at the buffer amplifiers (Q11, Q12) and then applied to the PLL IC (IC4, pin 8) via the low-pass filter (L32, C298–C300).

The PLL IC contains a prescaler, programmable counter, programmable divider and phase detector, etc. The entered signal is divided at the prescaler and programmable counter section by the N-data ratio from the CPU. The reference signal is generated at the reference oscillator (X2) and is also applied to the PLL IC. The PLL IC detects the out-of-step phase using the reference frequency, and outputs it from pin 5. The output signal is passed through the loop filter (R97/C149, R96/C147), and is then applied to the VCO circuit as the lock voltage.

If the oscillated signal drifts, its phase changes from that of the reference frequency, causing a lock voltage change to compensate for the drift in the oscillated frequency.

4-3-2 VCO CIRCUIT (MAIN UNIT)

The VCO circuit contains a separate RX VCO (Q14, D33, D34) and TX VCO (Q13, D16, D18, D31). The oscillated signal is amplified at the buffer amplifiers (Q11, Q10) and is then applied to the T/R switch circuit (D14, D15). Then the receive 1st LO (RX) signal is applied to the 1st mixer (Q3) and the transmit (TX) signal to the drive amplifier circuit (Q8).

A portion of the signal from the buffer amplifier (Q11) is fed back to the PLL IC (IC4, pin 8) via the buffer amplifier (Q12) and low-pass filter (L32, C298–C300) as the comparison signal.

• PLL circuit

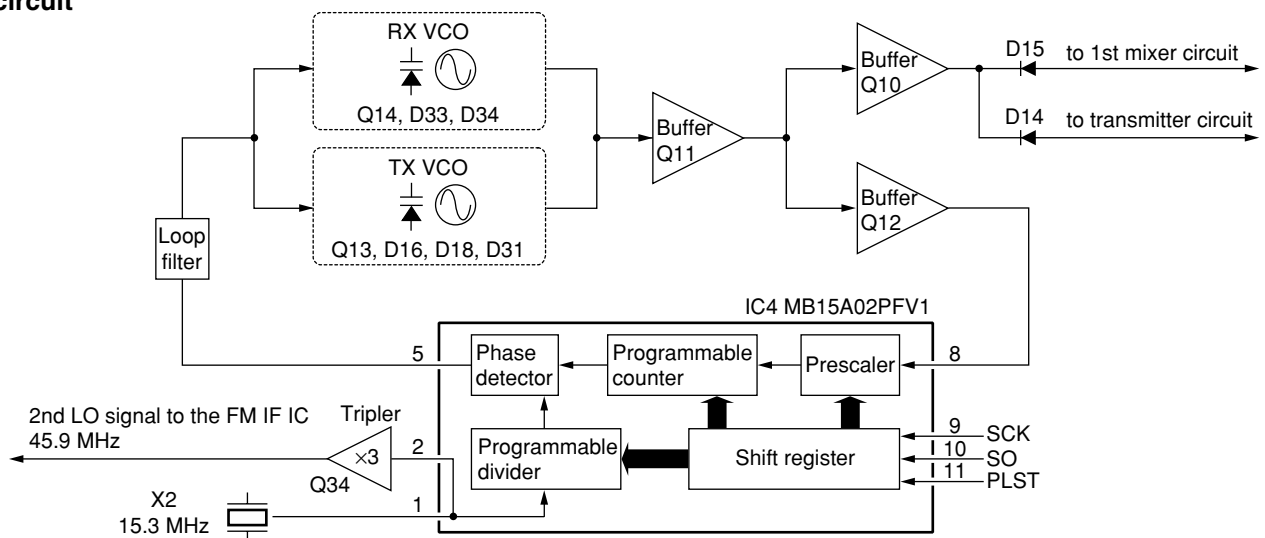

4-4 POWER SUPPLY CIRCUITS

4-4-1 VOLTAGE LINES (MAIN UNIT)

Line	Description
HV	The voltage from a DC power supply.
VCC	The same voltage as the HV line which is controlled by the power switching circuit (Q23, Q24). When the [POWER] switch is pushed, the CPU outputs the "PWON" control signal to the power switching circuit to turn the circuit ON.
CPU5V	Common 5 V for the CPU converted from the HV line by the CPU5V regulator circuit (IC10). The circuit outputs the voltage regardless of the power ON/OFF condition.
8V	Common 8 V converted from the VCC line by the 8V regulator circuit (IC9).
5V	Common 5 V converted from the VCC line by the 5V regulator circuit (Q27, Q28).
R8V	Receive 8 V controlled by the R8 regulator circuit (Q26, Q30) using the "RXC" signal from the CPU (FRONT unit; IC1, pin 18).
T8V	Transmit 8 V controlled by the T8 regulator circuit (Q25, Q29, D23) using the "TMUT" signal from the CPU (FRONT unit; IC1, pin 40).

4-5 PORT ALLOCATIONS

4-5-1 LED DRIVER (FRONT UNIT; IC4)

Pin number	Port name	Description
5–11	CH1–CH4 LP0–LP2	Output LEDs control signals. Low : While LEDs are ON.
14	RLED	Outputs BUSY LED control signal.
15	TLED	Outputs TX LED control signal.
16	LIGT1	Outputs LED bright control signal.
17	LIGT2	Outputs backlight control signal.
18	HORN	Outputs external device control signal. High : When matched 5/2 tone signals are received.

4-5-2 OUTPUT EXPANDER (MAIN UNIT; IC6)

Pin number	Port name	Description
2	VOUT1	Outputs squelch control signal.
3	VOUT2	Outputs deviation (Tone) control signal.
10	VOUT3	Outputs deviation control signal.
11	VOUT4	Outputs DTCS control signal.
14	VOUT5	Outputs RX BPF control signal.
15	VOUT6	Outputs AGC control signal.
22	VOUT7	Outputs TX RF power control signal.
23	VOUT8	Outputs PLL reference control signal.

4-5-3 CPU (FRONT UNIT; IC1)

Pin number	Port name	Description
1	TEMP	Input port for the internal temperature.
2	BATV	Input port for low voltage detection from the connected power supply.
7	RES	Input port for the reset signal.
13, 14	SENC0, SENC1	Output ports for 5/2 tone and DTMF signals.
15	CSFT	Outputs the CPU clock shift signal.
16	DUSE	Outputs the cut-off frequency control signal to the low-pass filter (MAIN; unit IC5) for CTCSS/DTCS switching.
17	UNLK	Input port for the PLL unlock signal from the PLL IC (MAIN unit; IC4).
18	RXC	Outputs the R8V regulator circuit (MAIN unit; Q26, Q30) control signal.
19, 20	SENC0, SENC1	Output ports for 5/2 tone and DTMF signals.
21, 22	P0, P1	Input ports for key matrix.
23–25	CENO0– CENO2	Output ports for CTCSS/DTCS signals.
26, 27	P2, P3	Input ports for key matrix.
28	SCK	Outputs clock signal to the PLL IC (MAIN unit; IC4), D/A converter (MAIN unit IC6), LED driver (FRONT unit; IC4) and optional board (connect to MAIN unit; J1).
29	SO	Outputs data signal to the PLL IC (MAIN unit; IC4), D/A converter (MAIN unit; IC6), LED driver (FRONT unit; IC4) and optional board (connect to MAIN unit; J1).
30	BEEP	Output port for beep sound signal.
31	ESDA	I/O port for the data signal for the EEPROM (FRONT unit; IC3).
32	ESCL	Outputs clock signal for EEPROM (FRONT unit; IC3).
33	MMUT	Input port for the MIC mute signal from the optional board via MAIN unit, J1.
34	RMUT	Input port for the AF mute signal from the optional board via MAIN unit, J1.
36	PLST	Outputs strobe signal for PLL IC (MAIN unit; IC4).
37	DAST	Outputs strobe signal for the D/A converter IC (MAIN unit; IC6).
38	EXST	Outputs strobe signal for LED driver IC (FRONT unit; IC4).
39	EXOE	Outputs control signal for the LED driver IC (FRONT unit; IC4).
40	TMUT	Outputs the T8V regulator circuit (MAIN unit; Q25, Q29, D23) control signal.

CPU-Continued

Pin number	Port name	Description
41	PWON	Outputs control signal for the power switching circuit (MAIN unit; Q24, Q23).
42	NWC	Outputs IF bandwidth control signal. Low : While IF bandwidth is narrow.
43	AFON	Outputs control signal for the AF mute circuit (MAIN unit; Q35, Q36, D29). High : While AF amplifier (MAIN unit; IC8) is activated.
44–46	OPT3– OPT1	I/O ports for the optional board control signals.
47	BUSY	Outputs BUSY detection signal for the optional board via MAIN unit, J1.
48	SI	Input port for the clock signal from the optional board via MAIN unit, J1.
49	CLI	Input port for the cloning signal.
50	CLO	Output port for the cloning signal.
51	POSW	Input for the POWER switch.
52	IGSW	Input port for the remote power control signal from external connector (MAIN unit; J6).
53	NOIS	Input port for the “NOIS” signal which is used noise squelch operation from the FM IF IC (MAIN unit; IC1).
54	CIRQ	Input port for the interruption signal from the optional board via MAIN unit, J1.
55	CCS	Outputs the chip select signal for the optional board via MAIN unit, J1.
56	PTT	Input port for the PTT switch from microphone.
57	EPTT	Input port for the PTT switch from the external connector (MAIN unit; J6). Low : External PTT switch is ON.
58	HANG	Input port for the microphone hanger detection signal. Low ; Microphone on hook.
59	AFVI	Input port for the AF volume control (FRONT unit; R14). High : [VOL] is maximum clockwise.
60	CDEC	Input port for CTCSS/DTCS decoding signals.
61	SDEC	Input port for the single tone decoding signals.
62	OPV1V2	Input port for the optional board detection signal.
63	RSSI	Input port for the detection signal of the received signal strength.
64	LVIN	Input port for the PLL lock voltage.

SECTION 5 ADJUSTMENT PROCEDURES

5-1 PREPARATION

When you adjust the contents on pages 5-5 and 5-6, SOFTWARE ADJUSTMENT, the optional CS-F100S ADJ ADJUSTMENT SOFTWARE (Rev. 1.0 or later), *OPC-1122 JIG CABLE (modified OPC-1122 CLONING CABLE; see illustration below) are required.

SYSTEM REQUIREMENTS

- IBM PC compatible computer with an RS -232C serial port (38400 bps or faster).
- Microsoft Windows 95/98 or Windows ME
- Intel Pentium 100 MHz processor or faster
- At least 16 MB RAM and 10 MB of hard disk space
- 640×480 pixel display (800×600 pixel display recommended)

IBM is a registered trademark of International Bussiness Machines Corporation in the U.S.A. and other countries. Microsoft and Windows are registered trademarks of Microsoft Corporation in the U.S.A. and other countries. Screen shots produced with permission from Microsoft Corporation. All other products or brands are registered trademarks or trademarks of their respective holders.

ADJUSTMENT SOFTWARE INSTALLATION

- ① Boot up Windows.
 - Quit all applications when Windows is running.
- ② Insert the 'CS-F100S' into the appropriate CD drive.
- ③ Select 'Run' from the [Start] menu.
- ④ Type the setup program name using the full path name, then push [Enter] key.
(ex. D:\CSF100SADJ\Setup.exe)
- ⑤ Follow the prompts.
- ⑥ Program group 'CS-F100S ADJ' appears in the 'Programs' folder of the [Start] menu.

STARTING SOFTWARE ADJUSTMENT

- ① Connect IC-F110S and PC with *OPC-1122 JIG CABLE.
- ② Turn the transceiver power ON.
- ③ Boot up Windows, and click the program group 'CS-F100S ADJ' in the 'Programs' folder of the [Start] menu, then CS-F100S ADJ's window appears.
- ④ Click 'Connect' on the CS-F100's window, then appears IC-F110S's up-to-date condition.
- ⑤ Set or modify adjustment data as desired.

*OPC-1122 (JIG CABLE)

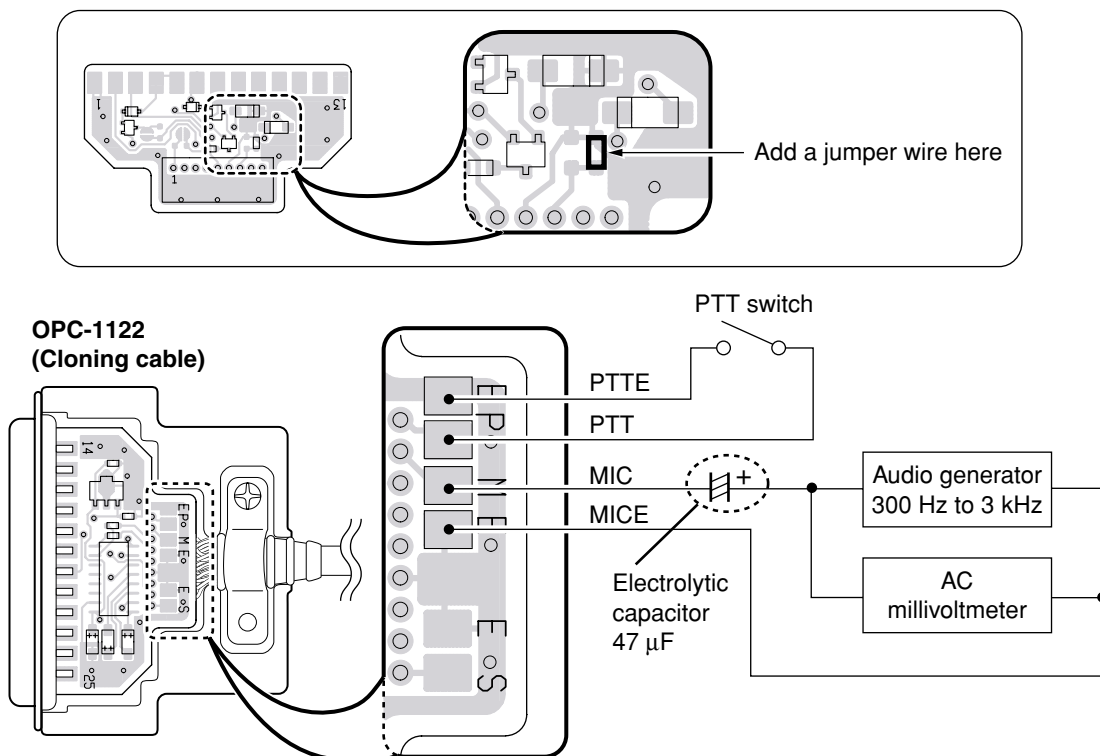

■ REQUIRED TEST EQUIPMENT

EQUIPMENT	GRADE AND RANGE	EQUIPMENT	GRADE AND RANGE
DC power supply	Output voltage : 13.2 V DC Current capacity : 15 A or more	Audio generator	Frequency range : 300–3000 Hz Measuring range : 1–500 mV
RF power meter (terminated type)	Measuring range : 1–100 W Frequency range : 100–300 MHz Impedance : 50 Ω SWR : Less than 1.2 : 1	Standard signal generator (SSG)	Frequency range : 0.1–300 MHz Output level : 0.1 μV–32 mV (–127 to –17 dBm)
Frequency counter	Frequency range : 0.1–300 MHz Frequency accuracy : ±1 ppm or better Sensitivity : 100 mV or better	Oscilloscope	Frequency range : DC–20 MHz Measuring range : 0.01–20 V
FM deviation meter	Frequency range : DC–300 MHz Measuring range : 0 to ±10 kHz	AC millivoltmeter	Measuring range : 10 mV–10 V
Digital multimeter	Input impedance : 50 kΩ/V DC or better	External speaker	Input impedance : 4 Ω Capacity : 7 W or more
		Attenuator	Power attenuation : 40 or 50 dB Capacity : 100 W or more

• Connections

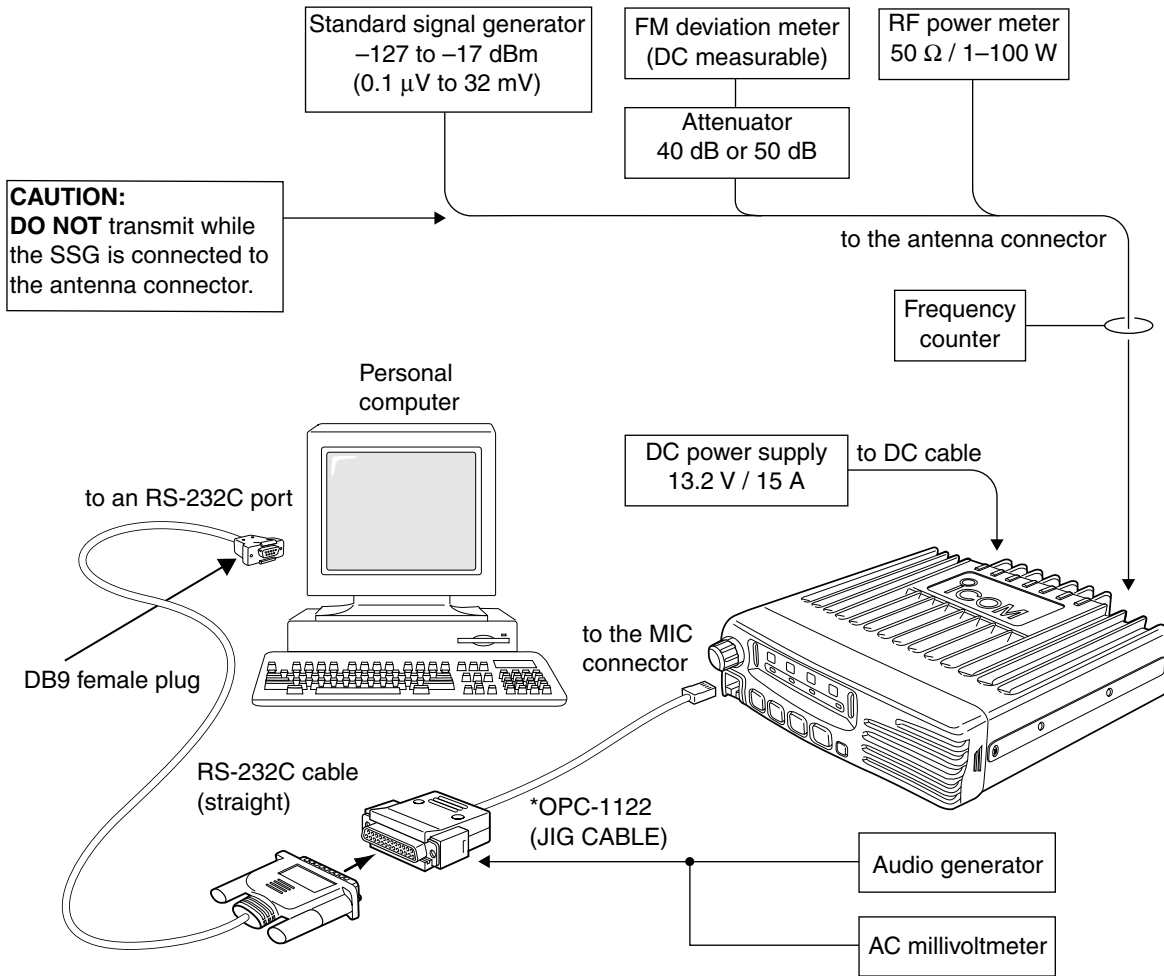

• Screen display example

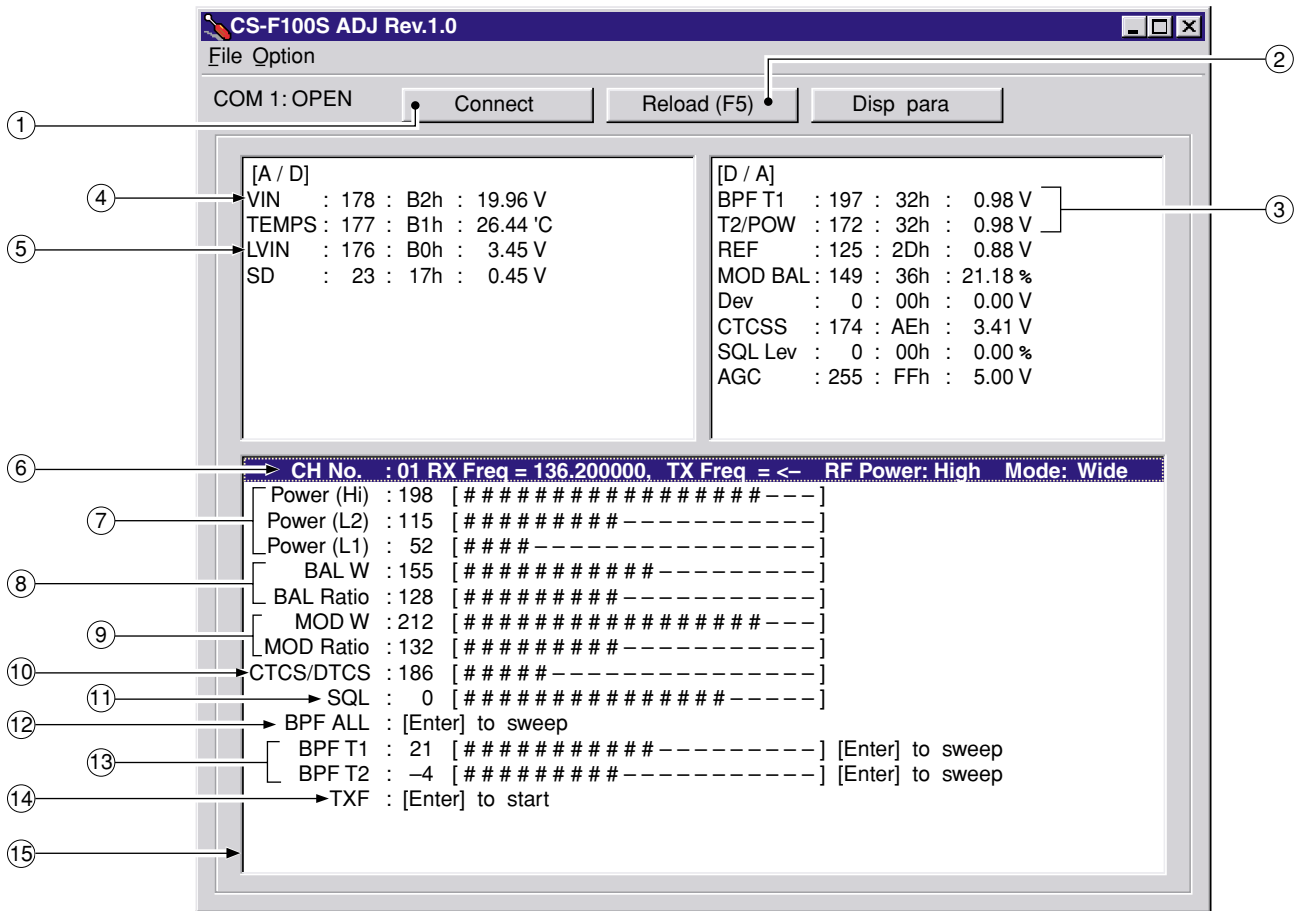

NOTE: The above values for settings are example only.
Each transceiver has its own specific values for each setting.

- | | |
|-------------------------------------|---|
| ① : Transceiver's connection state | ⑨ : FM deviation |
| ② : Reload adjustment data | ⑩ : CTCSS/DTCS deviation |
| ③ : Receive sensitivity measurement | ⑪ : Squelch level |
| ④ : Connected DC voltage | ⑫ : Receive sensitivity (automatically) |
| ⑤ : PLL lock voltage | ⑬ : Receive sensitivity (manually) |
| ⑥ : Operating channel select | ⑭ : Reference frequency |
| ⑦ : RF output power | ⑮ : Adjustment items |
| ⑧ : Modulation balance | |

5-2 PLL ADJUSTMENT

ADJUSTMENT	ADJUSTMENT CONDITIONS	MEASUREMENT		VALUE	ADJUSTMENT	
		UNIT	LOCATION		UNIT	ADJUST
PLL LOCK VOLTAGE	1 • Operating freq. : 174.000 MHz • Receiving	MAIN	Connect a digital multi-meter or an oscilloscope to the check point, "LV".	3.5 V	MAIN	C134
	2 • Output power : Low1 • Transmitting					C133
	3 • Operating freq. : 136.000 MHz • Receiving					Verify
	4 • Output power : Low1 • Transmitting					Verify

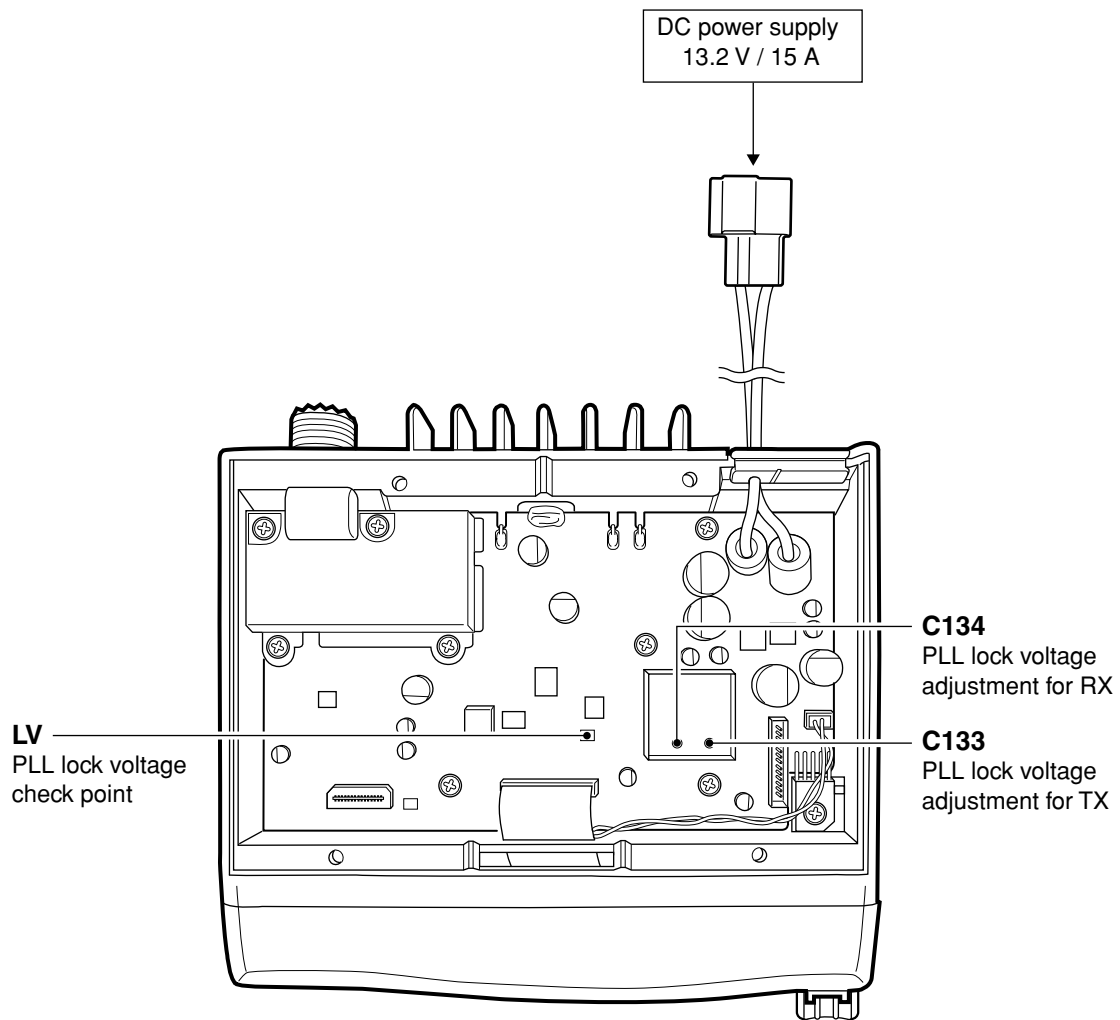

5-3 SOFTWARE ADJUSTMENT

Select an operation using [↑] / [↓] keys, then set specified value using [←] / [→] keys on the connected computer keyboard.

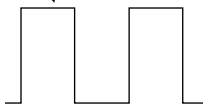
ADJUSTMENT	ADJUSTMENT CONDITION	MEASUREMENT		VALUE
		UNIT	LOCATION	
REFERENCE FREQUENCY [TXF]	1 <ul style="list-style-type: none"> • Operating freq. : 174.000 MHz • Output power : Low1 • Connect the RF power meter or 50 Ω dummy load to the antenna connector. • Transmitting 	Rear panel	Loosely couple a frequency counter to the antenna connector.	174.0000 MHz
OUTPUT POWER [Power (Hi)]	1 <ul style="list-style-type: none"> • Operating freq. : 155.000 MHz • Output power : High • Transmitting 	Rear panel	Connect an RF power meter to the antenna connector.	25.0 W [25 W] 50.0 W [50 W]
[Power (L2)]	2 <ul style="list-style-type: none"> • Output power : Low2 • Transmitting 			10.0 W [25W] 25.0 W [50 W]
[Power (L1)]	3 <ul style="list-style-type: none"> • Output power : Low1 • Transmitting 			2.5 W [25W] 5.0 W [50 W]
FM DEVIATION [MOD W]	1 <ul style="list-style-type: none"> • Operating freq. : 155.000 MHz • Output power : Low1 • IF bandwidth : Wide • Connect an audio generator to the [MIC] jack through the JIG cable and set as: 1.0 kHz/40 mVrms • Set an FM deviation meter as: HPF : OFF LPF : 20 kHz De-emphasis: OFF Detector : (P-P)/2 • Transmitting 	Rear panel	Connect an FM deviation meter to the antenna connector through the attenuator.	±4.1 kHz [N/W] ±3.3 kHz [N/M]
[MOD Ratio]	2 <ul style="list-style-type: none"> • IF bandwidth : Narrow • Transmitting 			±2.1 kHz
MODULATION BALLANCE [BAL W]	1 <ul style="list-style-type: none"> • Set to the DTCS set channel, and push [Connect] on the adjustment software. • Operating freq. : 174.000 MHz • Output power : Low1 • Transmitting 	Rear panel	Connect an FM deviation meter with an oscilloscope to the antenna connector through an attenuator.	Set to square wave form 
[BAL Ratio]	2 <ul style="list-style-type: none"> • IF bandwidth : Narrow • Transmitting 			
CTCSS/DTCS DEVIATION [CTCS/DTCS]	1 <ul style="list-style-type: none"> • Operating freq. : 155.000 MHz • Output power : Low1 • IF bandwidth : Wide • CTCSS : 88.5 Hz • DTCS code : 007 • Set the FM deviation meter as: HPF : OFF LPF : 20 kHz De-emphasis: OFF Detector : (P-P)/2 • No audio applied to the [MIC] connector. • Transmitting 	Rear panel	Connect an FM deviation meter to the antenna connector through the attenuator.	±0.68 kHz [N/W] ±0.56 kHz [N/M]

SOFTWARE ADJUSTMENT – continued

Select an operation using [↑] / [↓] keys, then set specified value using [←] / [→] keys on the connected computer keyboard.

ADJUSTMENT	ADJUSTMENT CONDITION	MEASUREMENT		VALUE	
		UNIT	LOCATION		
RX SENSITIVITY [BPF T1], [BPF T2]	1	<ul style="list-style-type: none"> Operating freq. : 136.000 MHz IF bandwidth : Wide Connect a standard signal generator to the antenna connector and set as: <ul style="list-style-type: none"> Frequency : 136.000 MHz Level : 10 μV* (-87 dBm) Modulation : 1 kHz Deviation : ±3.5 kHz [N/W] ±2.8 kHz [N/M] Receiving 	MAIN	Connect a SINAD meter with a 4 Ω load to the external [SP] jack.	Minimum distortion level
	<p>CONVENIENT: The BPF T1–BPF T2 can be adjusted automatically.</p> <p>①-1: Set the cursor to “BPF ALL” on the adjustment program and then push [ENTER] key.</p> <p>①-2: The connected PC tunes BPF T1, BPF T2 to peak levels.</p> <p style="text-align: center;">or</p> <p>②-1: Set the cursor to BPF T1 or BPF T2 as desired.</p> <p>②-2: Push [ENTER] key to start tuning.</p> <p>②-3: Repeat ②-1 and ②-2 to perform additional BPF tuning.</p>				
SQUELCH LEVEL [SQL]	1	<ul style="list-style-type: none"> Operating freq. : 155.000 MHz IF bandwidth : Narrow Connect an SSG to the antenna connector and set as: <ul style="list-style-type: none"> Frequency : 155.000 MHz Level : 0.2 μV* (-121 dBm) Modulation : 1 kHz Deviation : ±1.75 kHz Receiving 	Rear panel	Connect a SINAD meter with a 4 Ω load to the external [SP] jack.	Set “SQL level” to close squelch. Then set “SQL level” at the point where the audio signals just appears.

*The output level of the standard signal generator (SSG) is indicated as the SSG’s open circuit.

5-4 TRIMMER ADJUSTMENT

- Make this adjustment if necessary (For example, when beep sound is too loud or too soft).
- **BE CAREFUL!**: 5-tone calling beep sound becomes loud or soft when beep volume adjusts to loud or soft.

ADJUSTMENT	ADJUSTMENT CONDITIONS	MEASUREMENT		ADJUSTMENT	
		UNIT	LOCATION	UNIT	ADJUST
BEEP VOLUME	1 <ul style="list-style-type: none"> • Operating freq. : Any • Receiving 	FRONT	Push any button except [POWER] switch, then verify the beep volume level.	FRONT	R59

• FRONT PANEL

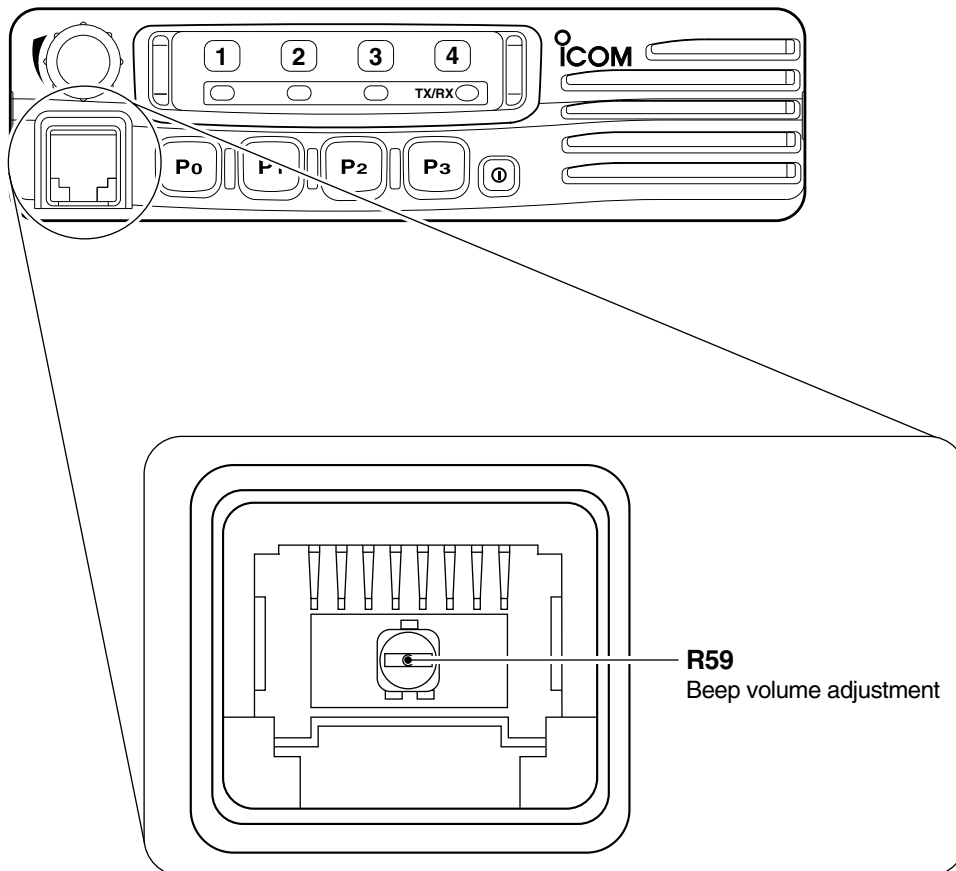

SECTION 6 PARTS LIST

[FRONT UNIT]

REF NO.	ORDER NO.	DESCRIPTION	
IC1	1140010890	S.IC	HD6433687A05FP
IC2	1110005770	S.IC	S-80942CNMC-G9C-T2
IC3	1130010390	S.IC	HN58X2416T1
IC4	1130009670	S.IC	BU2092FV-E2
IC5	1110005340	S.IC	NJM12902V-TE1
Q1	1530002060	S.TRANSISTOR	2SC4081 T106 R
Q2	1590001050	S.TRANSISTOR	DTC114TUA T106
Q3	1590000430	S.TRANSISTOR	DTC144EUA T106
D1	1790000950	S.ZENER	MA8056-M (TX)
D2	1790000950	S.ZENER	MA8056-M (TX)
D3	1790000950	S.ZENER	MA8056-M (TX)
D4	1790000620	S.DIODE	MA77 (TX)
D5	1790001250	S.DIODE	MA2S111-(TX)
X1	6050009520	S.XTAL	CR-520 (19.6608 MHz)
L1	6200003640	S.COIL	MLF1608E 100K-T
L2	6200001980	S.COIL	NL 252018T-1R0J
R1	7030008400	S.RESISTOR	ERJ2GEJ 182 X (1.8 kΩ)
R2	7030009280	S.RESISTOR	ERJ2GE
R3	7030005120	S.RESISTOR	ERJ2GEJ 102 X (1 kΩ)
R4	7030005120	S.RESISTOR	ERJ2GEJ 102 X (1 kΩ)
R5	7030005120	S.RESISTOR	ERJ2GEJ 102 X (1 kΩ)
R6	7030005010	S.RESISTOR	ERJ2GEJ 681 X (680 Ω)
R7	7030005010	S.RESISTOR	ERJ2GEJ 681 X (680 Ω)
R8	7030005010	S.RESISTOR	ERJ2GEJ 681 X (680 Ω)
R9	7030005010	S.RESISTOR	ERJ2GEJ 681 X (680 Ω)
R10	7030005030	S.RESISTOR	ERJ2GEJ 152 X (1.5 kΩ)
R11	7030008370	S.RESISTOR	ERJ2GEJ 561 X (560 Ω)
R12	7030009280	S.RESISTOR	ERJ2GE
R13	7030005050	S.RESISTOR	ERJ2GEJ 103 X (10 kΩ)
R14	7210003020	VARIABLE	EVU-F2KFK1 B14 (10KB)
R15	7030005120	S.RESISTOR	ERJ2GEJ 102 X (1 kΩ)
R16	7030005120	S.RESISTOR	ERJ2GEJ 102 X (1 kΩ)
R17	7030005090	S.RESISTOR	ERJ2GEJ 104 X (100 kΩ)
R18	7030005090	S.RESISTOR	ERJ2GEJ 104 X (100 kΩ)
R19	7030005090	S.RESISTOR	ERJ2GEJ 104 X (100 kΩ)
R20	7030008300	S.RESISTOR	ERJ2GEJ 184 X (180 kΩ)
R21	7030005720	S.RESISTOR	ERJ2GEJ 563 X (56 kΩ)
R22	7030005220	S.RESISTOR	ERJ2GEJ 223 X (22 kΩ)
R23	7030005240	S.RESISTOR	ERJ2GEJ 473 X (47 kΩ)
R24	7030005240	S.RESISTOR	ERJ2GEJ 473 X (47 kΩ)
R25	7030005220	S.RESISTOR	ERJ2GEJ 223 X (22 kΩ)
R26	7030005240	S.RESISTOR	ERJ2GEJ 473 X (47 kΩ)
R27	7030005240	S.RESISTOR	ERJ2GEJ 473 X (47 kΩ)
R28	7030005040	S.RESISTOR	ERJ2GEJ 472 X (4.7 kΩ)
R29	7030005220	S.RESISTOR	ERJ2GEJ 223 X (22 kΩ)
R30	7030005110	S.RESISTOR	ERJ2GEJ 224 X (220 kΩ)
R31	7030005090	S.RESISTOR	ERJ2GEJ 104 X (100 kΩ)
R32	7030005240	S.RESISTOR	ERJ2GEJ 473 X (47 kΩ)
R33	7030005220	S.RESISTOR	ERJ2GEJ 223 X (22 kΩ)
R34	7030005220	S.RESISTOR	ERJ2GEJ 223 X (22 kΩ)
R35	7030005070	S.RESISTOR	ERJ2GEJ 683 X (68 kΩ)
R36	7030005070	S.RESISTOR	ERJ2GEJ 683 X (68 kΩ)
R37	7030005070	S.RESISTOR	ERJ2GEJ 683 X (68 kΩ)
R38	7030005070	S.RESISTOR	ERJ2GEJ 683 X (68 kΩ)
R39	7030005070	S.RESISTOR	ERJ2GEJ 683 X (68 kΩ)
R40	7030005240	S.RESISTOR	ERJ2GEJ 473 X (47 kΩ)
R41	7030005050	S.RESISTOR	ERJ2GEJ 103 X (10 kΩ)
R42	7030007350	S.RESISTOR	ERJ2GEJ 393 X (39 kΩ)
R43	7030005060	S.RESISTOR	ERJ2GEJ 333 X (33 kΩ)
R44	7030005100	S.RESISTOR	ERJ2GEJ 154 X (150 kΩ)
R45	7030005530	S.RESISTOR	ERJ2GEJ 100 X (10 Ω)
R46	7030005160	S.RESISTOR	ERJ2GEJ 105 X (1 MΩ)
R47	7030008010	S.RESISTOR	ERJ2GEJ 123 X (12 kΩ)
R48	7030008010	S.RESISTOR	ERJ2GEJ 123 X (12 kΩ)
R49	7030008010	S.RESISTOR	ERJ2GEJ 123 X (12 kΩ)
R50	7410001130	S.ARRAY	EXB28V102JX

[FRONT UNIT]

REF NO.	ORDER NO.	DESCRIPTION	
R51	7030005090	S.RESISTOR	ERJ2GEJ 104 X (100 kΩ)
R52	7030005120	S.RESISTOR	ERJ2GEJ 102 X (1 kΩ)
R53	7410001130	S.ARRAY	EXB28V102JX
R54	7410001130	S.ARRAY	EXB28V102JX
R55	7410000770	S.ARRAY	EXB-V4V 102JV (1 kΩ)
R56	7410001130	S.ARRAY	EXB28V102JX
R57	7030005160	S.RESISTOR	ERJ2GEJ 105 X (1 MΩ)
R58	7030005050	S.RESISTOR	ERJ2GEJ 103 X (10 kΩ)
R59	7310002740	S.TRIMMER	RV-150 (RH03A3A14X0FC) 103
R60	7030005090	S.RESISTOR	ERJ2GEJ 104 X (100 kΩ)
R61	7030005090	S.RESISTOR	ERJ2GEJ 104 X (100 kΩ)
R62	7030005090	S.RESISTOR	ERJ2GEJ 104 X (100 kΩ)
R63	7030005090	S.RESISTOR	ERJ2GEJ 104 X (100 kΩ)
R64	7030005090	S.RESISTOR	ERJ2GEJ 104 X (100 kΩ)
R65	7030005090	S.RESISTOR	ERJ2GEJ 104 X (100 kΩ)
R66	7030005090	S.RESISTOR	ERJ2GEJ 104 X (100 kΩ)
R67	7030005050	S.RESISTOR	ERJ2GEJ 103 X (10 kΩ)
R68	7030005050	S.RESISTOR	ERJ2GEJ 103 X (10 kΩ)
R69	7030005090	S.RESISTOR	ERJ2GEJ 104 X (100 kΩ)
R70	7030005030	S.RESISTOR	ERJ2GEJ 152 X (1.5 kΩ)
R71	7030005120	S.RESISTOR	ERJ2GEJ 102 X (1 kΩ)
R72	7030005030	S.RESISTOR	ERJ2GEJ 152 X (1.5 kΩ)
R73	7030006610	S.RESISTOR	ERJ2GEJ 394 X (390 kΩ)
C1	4030016930	S.CERAMIC	ECJ0EB1A104K
C2	4030017420	S.CERAMIC	ECJ0EC1H470J
C3	4030017420	S.CERAMIC	ECJ0EC1H470J
C4	4030017420	S.CERAMIC	ECJ0EC1H470J
C5	4030017420	S.CERAMIC	ECJ0EC1H470J
C6	4030017420	S.CERAMIC	ECJ0EC1H470J
C7	4030017420	S.CERAMIC	ECJ0EC1H470J
C8	4030017460	S.CERAMIC	ECJ0EB1E102K
C9	4030017460	S.CERAMIC	ECJ0EB1E102K
C10	4030017460	S.CERAMIC	ECJ0EB1E102K
C11	4030017420	S.CERAMIC	ECJ0EC1H470J
C12	4030017460	S.CERAMIC	ECJ0EB1E102K
C14	4030017460	S.CERAMIC	ECJ0EB1E102K
C15	4030017900	S.CERAMIC	ECJ0EB1C123K
C16	4030016930	S.CERAMIC	ECJ0EB1A104K
C17	4030017740	S.CERAMIC	ECJ0EB1E821K
C19	4030016930	S.CERAMIC	ECJ0EB1A104K
C20	4030018110	S.CERAMIC	ECJ0EB1H272K
C21	4030018240	S.CERAMIC	ECJ0EB1E562K
C22	4030017710	S.CERAMIC	ECJ0EC1H181J
C23	4030018090	S.CERAMIC	ECJ0EB1C822K
C24	4030017510	S.CERAMIC	ECJ0EC1H680J
C25	4030016790	S.CERAMIC	ECJ0EB1C103K
C26	4030016930	S.CERAMIC	ECJ0EB1A104K
C27	4030017450	S.CERAMIC	ECJ0EB1E271K
C28	4030016930	S.CERAMIC	ECJ0EB1A104K
C29	4550006050	S.TANTALUM	TEMSVA OJ 106M8L
C30	4030017030	S.CERAMIC	ECJ0EB1A273K
C31	4030017400	S.CERAMIC	ECJ0EC1H220J
C32	4030017640	S.CERAMIC	ECJ0EC1H150J
C33	4030017510	S.CERAMIC	ECJ0EC1H680J
C34	4030017730	S.CERAMIC	ECJ0EB1E471K
C35	4030016930	S.CERAMIC	ECJ0EB1A104K
C36	4030016930	S.CERAMIC	ECJ0EB1A104K
C38	4030018390	S.CERAMIC	ECJ0EB1A563K
C50	4030017420	S.CERAMIC	ECJ0EC1H470J
C54	4030017420	S.CERAMIC	ECJ0EC1H470J
C74	4030017420	S.CERAMIC	ECJ0EC1H470J
C75	4030016930	S.CERAMIC	ECJ0EB1A104K
C76	4030016930	S.CERAMIC	ECJ0EB1A104K
C77	4030016950	S.CERAMIC	ECJ0EB1A473K
C78	4030017460	S.CERAMIC	ECJ0EB1E102K
C82	4030017460	S.CERAMIC	ECJ0EB1E102K
C84	4030017460	S.CERAMIC	ECJ0EB1E102K
C85	4030017460	S.CERAMIC	ECJ0EB1E102K
C86	4030017460	S.CERAMIC	ECJ0EB1E102K
C87	4030017460	S.CERAMIC	ECJ0EB1E102K
C88	4030017460	S.CERAMIC	ECJ0EB1E102K
J1	6450002210	CONNECTOR	3017-8821

Ⓐ: IC-F110S

Ⓑ: IC-F120S/F111S

Ⓒ: IC-F110S for [EUR]

Ⓓ: Narrow/wide version

Ⓔ: Narrow/middle version

S.=Surface mount

Ⓒ only
Ⓒ only
Ⓒ only

Ⓒ only

[FRONT UNIT]

REF NO.	ORDER NO.	DESCRIPTION	
J2	6510022470	S.CONNECTOR	40FLT-SM1-TB
DS1	5040002670	S.LED	CL-165HR/YG
DS2	5040002310	S.LED	SML-311YTT86
DS3	5040002310	S.LED	SML-311YTT86
DS4	5040002310	S.LED	SML-311YTT86
DS5	5040002310	S.LED	SML-311YTT86
DS6	5040002310	S.LED	SML-311YTT86
DS7	5040002310	S.LED	SML-311YTT86
DS8	5040002310	S.LED	SML-311YTT86
DS9	5040002310	S.LED	SML-311YTT86
DS10	5040002310	S.LED	SML-311YTT86
SP1	2510001220	SPEAKER	C052SB500-13
W1	8900010500	CABLE	OPC-1046
W2	8900011800	CABLE	OPC-1199
EP1	0910055554	PCB	B 5872D

[MAIN UNIT]

REF NO.	ORDER NO.	DESCRIPTION	
IC1	1110003490	S.IC	TA31136FN (D,EL)
IC2	1110002750	S.IC	TA75S01F (TE85R)
IC3	1150002040	IC	RA30H1317M-01
	1150002100	IC	S-AV32 (I)
IC4	1140005990	S.IC	MB15A02PFV1-G-BND-ER
IC5	1110005330	S.IC	NJM12904V-TE1
IC6	1190000350	S.IC	M62363FP-650C
IC8	1110003090	IC	LA4425A
IC9	1180001250	S.IC	TA7808F (TE16L)
IC10	1180000970	S.IC	AN78L05M-(E1)
IC14	1130008090	S.IC	BU4066BCFV-E1
IC15	1110002750	S.IC	TA75S01F (TE85R)
IC16	1110005340	S.IC	NJM12902V-TE1
Q1	1560000840	S.FET	2SK1829 (TE85R)
Q2	1580000730	S.FET	3SK293 (TE85L)
Q3	1580000760	S.FET	3SK299-T1 U73
Q4	1530002600	S.TRANSISTOR	2SC4215-O (TE85R)
Q5	1590000430	S.TRANSISTOR	DTC144EUA T106
Q8	1530000371	S.TRANSISTOR	2SC3356-T1B R25
Q10	1530003310	S.TRANSISTOR	2SC5107-O (TE85R)
Q11	1530003310	S.TRANSISTOR	2SC5107-O (TE85R)
Q12	1530003310	S.TRANSISTOR	2SC5107-O (TE85R)
Q13	1530002920	S.TRANSISTOR	2SC4226-T1 R25
Q14	1530002920	S.TRANSISTOR	2SC4226-T1 R25
Q15	1590001400	S.TRANSISTOR	XP1214 (TX)
Q16	1590000430	S.TRANSISTOR	DTC144EUA T106
Q17	1530002850	S.TRANSISTOR	2SC4116-BL (TE85R)
Q18	1560000540	S.FET	2SK880-Y (TE85R)
Q19	1530002600	S.TRANSISTOR	2SC4215-O (TE85R)
Q20	1530002850	S.TRANSISTOR	2SC4116-BL (TE85R)
Q23	1550000020	S.FET	2SJ377 (TE16R)
Q24	1590000430	S.TRANSISTOR	DTC144EUA T106
Q25	1540000550	S.TRANSISTOR	2SD1664 T100Q
Q26	1510000920	S.TRANSISTOR	2SA1577 T106 Q
Q27	1510000920	S.TRANSISTOR	2SA1577 T106 Q
Q28	1590001190	S.TRANSISTOR	XP6501-(TX) .AB
Q29	1590001050	S.TRANSISTOR	DTC114TUA T106
Q30	1590000430	S.TRANSISTOR	DTC144EUA T106
Q31	1590001450	S.FET	2SJ144-GR (TE85R)
Q33	1590000430	S.TRANSISTOR	DTC144EUA T106
Q34	1530002850	S.TRANSISTOR	2SC4116-BL (TE85R)
Q35	1590000990	S.TRANSISTOR	DTC363EK T146
Q36	1590000430	S.TRANSISTOR	DTC144EUA T106
D1	1790001210	S.DIODE	1SS375-TL
D2	1750000510	S.DIODE	UM9401F

[MAIN UNIT]

REF NO.	ORDER NO.	DESCRIPTION	
D3	1710001060	DIODE	XB15A407
D4	1750000720	S.VARICAP	HVC375BTRF
D5	1790000620	S.DIODE	MA77 (TX)
D6	1790000620	S.DIODE	MA77 (TX)
D7	1790001240	S.DIODE	MA2S728-(TX)
D8	1750000720	S.VARICAP	HVC375BTRF
D9	1750000710	S.VARICAP	HVC350BTRF
D10	1750000710	S.VARICAP	HVC350BTRF
D11	1790001210	S.DIODE	1SS375-TL
D12	1790001210	S.DIODE	1SS375-TL
D14	1790000620	S.DIODE	MA77 (TX)
D15	1790000620	S.DIODE	MA77 (TX)
D16	1750000770	S.VARICAP	HVC376BTRF
D18	1720000470	S.VARICAP	1SV239 (TPH3)
D20	1790001250	S.DIODE	MA2S111-(TX)
D21	1750000830	S.VARICAP	HVC362TRF
D22	1790000700	DIODE	DSA3A1
D23	1750000370	S.DIODE	DA221 TL
D26	1790001250	S.DIODE	MA2S111-(TX)
D27	1790001250	S.DIODE	MA2S111-(TX)
D28	1790001240	S.DIODE	MA2S728-(TX)
D29	1790001250	S.DIODE	MA2S111-(TX)
D30	1750000520	S.DIODE	DAN222TL
D31	1750000770	S.VARICAP	HVC376BTRF
D33	1750000770	S.VARICAP	HVC376BTRF
D34	1750000770	S.VARICAP	HVC376BTRF
D37	1790001250	S.DIODE	MA2S111-(TX)
D38	1750000510	S.DIODE	UM9401F
D40	1750000520	S.DIODE	DAN222TL
D41	1790000620	S.DIODE	MA77 (TX)
D42	1750000370	S.DIODE	DA221 TL
D43	1790001250	S.DIODE	MA2S111-(TX)
F11	2030000150	S.MONOLITH	FL-335 (46.350 MHz)
F12	2020001840	CERAMIC	ALFYM450F=K
F13	2040001440	S.LC	NFE31PT152Z1E9L
F14	2040001440	S.LC	NFE31PT152Z1E9L
F15	2040001440	S.LC	NFE31PT152Z1E9L
X1	6070000190	S.DISCRIMINATOR	CDBC450KCA24-R0
X2	6050011510	S.XTAL	CR-740 (15.300 MHz)
L1	6200010050	S.COIL	AS080547-47N
L2	6200010050	S.COIL	AS080547-47N
L3	6200010050	S.COIL	AS080547-47N
L4	6200010430	S.COIL	0.50-2.0-6TL
L5	6200010420	S.COIL	FHW1210HC 1R0JGT
L6	6200010400	S.COIL	ELJRE 39NJ 39N
L7	6200008090	S.COIL	LQW2BHN68NJ01L
L8	6200008090	S.COIL	LQW2BHN68NJ01L
L9	6200007750	S.COIL	LQW2BHN56NJ01L
L10	6200004660	S.COIL	MLF1608A 1R8K-T
L11	6200007750	S.COIL	LQW2BHN56NJ01L
L12	6200009180	S.COIL	ELJRE R10J-F3
L13	6200003330	S.COIL	NL 322522T-1R0J-3
L16	6200010050	S.COIL	AS080547-47N
L18	6200009170	S.COIL	ELJRE 47NJ-F2
L19	6200009150	S.COIL	ELJRE 82NJ-F3
L21	6200009150	S.COIL	ELJRE 82NJ-F3
L22	6200009160	S.COIL	ELJRE 68NJ-F3
L25	6200009460	S.COIL	0.25-1.9-7TL 67N
L26	6200008390	S.COIL	0.25-1.9-9TL
L27	6200002000	S.COIL	NL 252018T-3R3J
L28	6200002000	S.COIL	NL 252018T-3R3J
L29	6200004660	S.COIL	MLF1608A 1R8K-T
L31	6200007750	S.COIL	LQW2BHN56NJ01L
L32	6200010390	S.COIL	ELJRE 33NJ-F3
L33	6200004480	S.COIL	MLF1608D R82K-T
L35	6200003540	S.COIL	MLF1608D R22K-T
L37	6200003640	S.COIL	MLF1608E 100K-T
L38	6200008190	S.COIL	0.25-1.9-8TL 80N
L39	6200008150	S.COIL	0.35-1.6-7TL 44N
L41	6200009160	S.COIL	ELJRE 68NJ-F3
R1	7030000620	S.RESISTOR	MCR10EZHZJ 100 kΩ
R2	7030000220	S.RESISTOR	MCR10EZHZJ 47 Ω (470)
R3	7030000220	S.RESISTOR	MCR10EZHZJ 47 Ω (470)
R4	7030003370	S.RESISTOR	ERJ3GGEYJ 271 V (270 Ω)

Ⓐ: IC-F110S

Ⓑ: IC-F120S/F111S

Ⓒ: IC-F110S for [EUR]

Ⓓ: Narrow/wide version

Ⓔ: Narrow/middle version

S.=Surface mount

[MAIN UNIT]

REF NO.	ORDER NO.	DESCRIPTION
R5	7030003560	S.RESISTOR ERJ3GEYJ 103 V (10 kΩ) (A)
		S.RESISTOR ERJ3GEYJ 273 V (27 kΩ) (B)
R6	7030003610	S.RESISTOR ERJ3GEYJ 273 V (27 kΩ) (B)
	7030003620	S.RESISTOR ERJ3GEYJ 333 V (33 kΩ) (A)
R7	7030003370	S.RESISTOR ERJ3GEYJ 271 V (270 Ω)
R8	7030006070	S.RESISTOR ERJ12YJ101U (100 Ω)
R9	7030003560	S.RESISTOR ERJ3GEYJ 103 V (10 kΩ) (B) only
R10	7030003730	S.RESISTOR ERJ3GEYJ 274 V (270 kΩ) (B) only
R11	7030003680	S.RESISTOR ERJ3GEYJ 104 V (100 kΩ)
R13	7030003680	S.RESISTOR ERJ3GEYJ 104 V (100 kΩ)
R14	7030003560	S.RESISTOR ERJ3GEYJ 103 V (10 kΩ)
R15	7030003740	S.RESISTOR ERJ3GEYJ 334 V (330 kΩ)
R16	7030003360	S.RESISTOR ERJ3GEYJ 221 V (220 Ω)
R17	7030004050	S.RESISTOR ERJ3GEYJ 1R0 V (1 Ω)
R18	7030003360	S.RESISTOR ERJ3GEYJ 221 V (220 Ω)
R19	7030003680	S.RESISTOR ERJ3GEYJ 104 V (100 kΩ)
R20	7030003440	S.RESISTOR ERJ3GEYJ 102 V (1 kΩ)
R21	7030003720	S.RESISTOR ERJ3GEYJ 224 V (220 kΩ)
R22	7030003560	S.RESISTOR ERJ3GEYJ 103 V (10 kΩ)
R23	7030003700	S.RESISTOR ERJ3GEYJ 154 V (150 kΩ)
R25	7030003440	S.RESISTOR ERJ3GEYJ 102 V (1 kΩ)
R26	7030003400	S.RESISTOR ERJ3GEYJ 471 V (470 Ω)
R27	7030003400	S.RESISTOR ERJ3GEYJ 471 V (470 Ω)
R28	7030003210	S.RESISTOR ERJ3GEYJ 120 V (12 Ω)
R29	7030003320	S.RESISTOR ERJ3GEYJ 101 V (100 Ω)
R31	7030003320	S.RESISTOR ERJ3GEYJ 101 V (100 Ω)
R32	7030003320	S.RESISTOR ERJ3GEYJ 101 V (100 Ω)
R33	7030003380	S.RESISTOR ERJ3GEYJ 331 V (330 Ω)
R34	7030003680	S.RESISTOR ERJ3GEYJ 104 V (100 kΩ)
R35	7030003320	S.RESISTOR ERJ3GEYJ 101 V (100 Ω)
R36	7030003510	S.RESISTOR ERJ3GEYJ 392 V (3.9 kΩ)
R37	7030003490	S.RESISTOR ERJ3GEYJ 272 V (2.7 kΩ) (D)
	7030003520	S.RESISTOR ERJ3GEYJ 472 V (4.7 kΩ) (E)
R38	7030003680	S.RESISTOR ERJ3GEYJ 104 V (100 kΩ)
R39	7030003280	S.RESISTOR ERJ3GEYJ 470 V (47 Ω)
R40	7030003460	S.RESISTOR ERJ3GEYJ 152 V (1.5 kΩ)
R42	7030003640	S.RESISTOR ERJ3GEYJ 473 V (47 kΩ)
R43	7030003400	S.RESISTOR ERJ3GEYJ 471 V (470 Ω)
R44	7030003750	S.RESISTOR ERJ3GEYJ 394 V (390 kΩ)
R45	7030003700	S.RESISTOR ERJ3GEYJ 154 V (150 kΩ)
R46	7030003480	S.RESISTOR ERJ3GEYJ 222 V (2.2 kΩ)
R48	7030003710	S.RESISTOR ERJ3GEYJ 184 V (180 kΩ) (B) only
R49	7520000230	S.POSISTOR PRF18BD471QB1RB (B) only
R50	7030003560	S.RESISTOR ERJ3GEYJ 103 V (10 kΩ)
R51	7030003680	S.RESISTOR ERJ3GEYJ 104 V (100 kΩ)
R52	7030003580	S.RESISTOR ERJ3GEYJ 153 V (15 kΩ)
R53	7030003360	S.RESISTOR ERJ3GEYJ 221 V (220 Ω)
R54	7030003550	S.RESISTOR ERJ3GEYJ 822 V (8.2 kΩ) (B)
	7030003560	S.RESISTOR ERJ3GEYJ 103 V (10 kΩ) (A)
R55	7030003520	S.RESISTOR ERJ3GEYJ 472 V (4.7 kΩ)
R56	7030003700	S.RESISTOR ERJ3GEYJ 154 V (150 kΩ)
R57	7030003560	S.RESISTOR ERJ3GEYJ 103 V (10 kΩ)
R58	7030003320	S.RESISTOR ERJ3GEYJ 101 V (100 Ω)
R59	7030003560	S.RESISTOR ERJ3GEYJ 103 V (10 kΩ) (B)
	7030003590	S.RESISTOR ERJ3GEYJ 183 V (18 kΩ) (A)
R60	7030003320	S.RESISTOR ERJ3GEYJ 101 V (100 Ω)
R61	7030003320	S.RESISTOR ERJ3GEYJ 101 V (100 Ω)
R62	7030003290	S.RESISTOR ERJ3GEYJ 560 V (56 Ω)
R63	7030003590	S.RESISTOR ERJ3GEYJ 183 V (18 kΩ) (B)
	7030003600	S.RESISTOR ERJ3GEYJ 223 V (22 kΩ) (A)
R67	7030003300	S.RESISTOR ERJ3GEYJ 680 V (68 Ω)
R68	7030003560	S.RESISTOR ERJ3GEYJ 103 V (10 kΩ)
R69	7030003520	S.RESISTOR ERJ3GEYJ 472 V (4.7 kΩ)
R70	7030003320	S.RESISTOR ERJ3GEYJ 101 V (100 Ω)
R71	7030003320	S.RESISTOR ERJ3GEYJ 101 V (100 Ω)
R73	7030003320	S.RESISTOR ERJ3GEYJ 101 V (100 Ω)
R74	7030003690	S.RESISTOR ERJ3GEYJ 124 V (120 kΩ)
R75	7030003690	S.RESISTOR ERJ3GEYJ 124 V (120 kΩ)
R76	7030003400	S.RESISTOR ERJ3GEYJ 471 V (470 Ω)
R77	7030003560	S.RESISTOR ERJ3GEYJ 103 V (10 kΩ)
R78	7030003440	S.RESISTOR ERJ3GEYJ 102 V (1 kΩ)
R79	7030003470	S.RESISTOR ERJ3GEYJ 182 V (1.8 kΩ)
R80	7030003440	S.RESISTOR ERJ3GEYJ 102 V (1 kΩ)
R82	7030004040	S.RESISTOR ERJ3GEYJ 4R7 V (4.7 Ω)
R83	7030003470	S.RESISTOR ERJ3GEYJ 182 V (1.8 kΩ)
R84	7030003510	S.RESISTOR ERJ3GEYJ 392 V (3.9 kΩ)
R85	7030003510	S.RESISTOR ERJ3GEYJ 392 V (3.9 kΩ)
R86	7030003690	S.RESISTOR ERJ3GEYJ 124 V (120 kΩ)
R89	7030003560	S.RESISTOR ERJ3GEYJ 103 V (10 kΩ)
R90	7030003640	S.RESISTOR ERJ3GEYJ 473 V (47 kΩ)
R91	7030003620	S.RESISTOR ERJ3GEYJ 333 V (33 kΩ)
R92	7030003680	S.RESISTOR ERJ3GEYJ 104 V (100 kΩ)

(A): IC-F110S

(B): IC-F120S/F111S

(C): IC-F110S for [EUR]

(D): Narrow/wide version

(E): Narrow/middle version

[MAIN UNIT]

REF NO.	ORDER NO.	DESCRIPTION
R93	7030003440	S.RESISTOR ERJ3GEYJ 102 V (1 kΩ)
R95	7030003400	S.RESISTOR ERJ3GEYJ 471 V (470 Ω)
R96	7030003460	S.RESISTOR ERJ3GEYJ 152 V (1.5 kΩ)
R97	7030003440	S.RESISTOR ERJ3GEYJ 102 V (1 kΩ)
R98	7030003480	S.RESISTOR ERJ3GEYJ 222 V (2.2 kΩ)
R99	7030003440	S.RESISTOR ERJ3GEYJ 102 V (1 kΩ)
R100	7030003560	S.RESISTOR ERJ3GEYJ 103 V (10 kΩ)
R101	7030003440	S.RESISTOR ERJ3GEYJ 102 V (1 kΩ)
R103	7030003700	S.RESISTOR ERJ3GEYJ 154 V (150 kΩ)
R104	7030003450	S.RESISTOR ERJ3GEYJ 122 V (1.2 kΩ)
R105	7030003640	S.RESISTOR ERJ3GEYJ 473 V (47 kΩ)
R106	7030003670	S.RESISTOR ERJ3GEYJ 823 V (8.2 kΩ)
R110	7030003280	S.RESISTOR ERJ3GEYJ 470 V (47 Ω)
R111	7030003500	S.RESISTOR ERJ3GEYJ 332 V (3.3 kΩ)
R112	7030003610	S.RESISTOR ERJ3GEYJ 273 V (27 kΩ)
R113	7030003480	S.RESISTOR ERJ3GEYJ 222 V (2.2 kΩ)
R114	7030003620	S.RESISTOR ERJ3GEYJ 333 V (33 kΩ)
R115	7030003510	S.RESISTOR ERJ3GEYJ 392 V (3.9 kΩ)
R116	7030003570	S.RESISTOR ERJ3GEYJ 123 V (12 kΩ)
R117	7030003710	S.RESISTOR ERJ3GEYJ 184 V (180 kΩ)
R118	7030003570	S.RESISTOR ERJ3GEYJ 123 V (12 kΩ)
R119	7030003530	S.RESISTOR ERJ3GEYJ 562 V (5.6 kΩ)
R120	7030003560	S.RESISTOR ERJ3GEYJ 103 V (10 kΩ)
R121	7030003640	S.RESISTOR ERJ3GEYJ 473 V (47 kΩ)
R122	7030003550	S.RESISTOR ERJ3GEYJ 823 V (8.2 kΩ)
R123	7030003680	S.RESISTOR ERJ3GEYJ 104 V (100 kΩ)
R124	7030003520	S.RESISTOR ERJ3GEYJ 472 V (4.7 kΩ)
R125	7030003680	S.RESISTOR ERJ3GEYJ 104 V (100 kΩ)
R126	7030003400	S.RESISTOR ERJ3GEYJ 471 V (470 Ω)
R127	7030003630	S.RESISTOR ERJ3GEYJ 393 V (39 kΩ)
R128	7030003560	S.RESISTOR ERJ3GEYJ 103 V (10 kΩ)
R129	7030003320	S.RESISTOR ERJ3GEYJ 101 V (100 Ω)
R130	7030003600	S.RESISTOR ERJ3GEYJ 223 V (22 kΩ)
R133	7030003710	S.RESISTOR ERJ3GEYJ 184 V (180 kΩ)
R134	7030003610	S.RESISTOR ERJ3GEYJ 273 V (27 kΩ)
R135	7030003730	S.RESISTOR ERJ3GEYJ 274 V (270 kΩ)
R136	7030003560	S.RESISTOR ERJ3GEYJ 103 V (10 kΩ)
R137	7030003690	S.RESISTOR ERJ3GEYJ 124 V (120 kΩ)
R138	7030003680	S.RESISTOR ERJ3GEYJ 104 V (100 kΩ)
R139	7030003680	S.RESISTOR ERJ3GEYJ 104 V (100 kΩ)
R141	7410001130	S.ARRAY EXB28V102JX
R142	7410001130	S.ARRAY EXB28V102JX
R143	7410001130	S.ARRAY EXB28V102JX
R144	7030003440	S.RESISTOR ERJ3GEYJ 102 V (1 kΩ)
R145	7030003440	S.RESISTOR ERJ3GEYJ 102 V (1 kΩ)
R146	7030003440	S.RESISTOR ERJ3GEYJ 102 V (1 kΩ)
R147	7410001130	S.ARRAY EXB28V102JX
R148	7410001130	S.ARRAY EXB28V102JX
R149	7410001130	S.ARRAY EXB28V102JX
R150	7410001130	S.ARRAY EXB28V102JX
R156	7030003520	S.RESISTOR ERJ3GEYJ 472 V (4.7 kΩ)
R159	7030003560	S.RESISTOR ERJ3GEYJ 103 V (10 kΩ)
R183	7030003720	S.RESISTOR ERJ3GEYJ 224 V (220 kΩ)
R184	7030003620	S.RESISTOR ERJ3GEYJ 333 V (33 kΩ)
R185	7030003690	S.RESISTOR ERJ3GEYJ 124 V (120 kΩ)
R186	7030003680	S.RESISTOR ERJ3GEYJ 104 V (100 kΩ)
R187	7030003560	S.RESISTOR ERJ3GEYJ 103 V (10 kΩ)
R188	7030003410	S.RESISTOR ERJ3GEYJ 561 V (560 Ω)
R191	7030003720	S.RESISTOR ERJ3GEYJ 224 V (220 kΩ)
R192	7030003720	S.RESISTOR ERJ3GEYJ 224 V (220 kΩ)
R193	7030003760	S.RESISTOR ERJ3GEYJ 474 V (470 kΩ)
R194	7030003480	S.RESISTOR ERJ3GEYJ 222 V (2.2 kΩ)
R195	7030003440	S.RESISTOR ERJ3GEYJ 102 V (1 kΩ)
R196	7030003600	S.RESISTOR ERJ3GEYJ 223 V (22 kΩ)
R197	7030003560	S.RESISTOR ERJ3GEYJ 103 V (10 kΩ)
R198	7030003560	S.RESISTOR ERJ3GEYJ 103 V (10 kΩ)
R199	7030003560	S.RESISTOR ERJ3GEYJ 103 V (10 kΩ)
R200	7030003560	S.RESISTOR ERJ3GEYJ 103 V (10 kΩ)
R201	7030003400	S.RESISTOR ERJ3GEYJ 471 V (470 Ω)
R202	7030000480	S.RESISTOR MCR10EZHH 6.8 kΩ
R203	7030000480	S.RESISTOR MCR10EZHH 6.8 kΩ
R204	7030003520	S.RESISTOR ERJ3GEYJ 472 V (4.7 kΩ)
R205	7030003560	S.RESISTOR ERJ3GEYJ 103 V (10 kΩ)
R206	7030000480	S.RESISTOR MCR10EZHH 6.8 kΩ
R209	7510001470	S.THERMISTOR NTCG20 4AG 473JT
R210	7030005871	S.RESISTOR ERA3YKD 104V (100 kΩ)
R211	7030003290	S.RESISTOR ERJ3GEYJ 560 V (56 Ω)
R212	7030003380	S.RESISTOR ERJ3GEYJ 331 V (330 Ω) (B)
	7030003460	S.RESISTOR ERJ3GEYJ 152 V (1.5 kΩ) (A)
R213	7030003560	S.RESISTOR ERJ3GEYJ 103 V (10 kΩ)
R214	7030003450	S.RESISTOR ERJ3GEYJ 122 V (1.2 kΩ) (B)
	7030003460	S.RESISTOR ERJ3GEYJ 152 V (1.5 kΩ) (A)

S.=Surface mount

[MAIN UNIT]

REF NO.	ORDER NO.		DESCRIPTION	
R215	7030003400	S.RESISTOR	ERJ3GEYJ 471 V (470 Ω)	
R216	7030003470	S.RESISTOR	ERJ3GEYJ 182 V (1.8 kΩ)	(B)
	7030003480	S.RESISTOR	ERJ3GEYJ 222 V (2.2 kΩ)	(A)
R217	7030003600	S.RESISTOR	ERJ3GEYJ 223 V (22 kΩ)	
R218	7030003600	S.RESISTOR	ERJ3GEYJ 223 V (22 kΩ)	
R219	7030003680	S.RESISTOR	ERJ3GEYJ 104 V (100 kΩ)	
R220	7030003640	S.RESISTOR	ERJ3GEYJ 473 V (47 kΩ)	
R221	7030003640	S.RESISTOR	ERJ3GEYJ 473 V (47 kΩ)	
R222	7030003560	S.RESISTOR	ERJ3GEYJ 103 V (10 kΩ)	
R223	7030003440	S.RESISTOR	ERJ3GEYJ 102 V (1 kΩ)	
R224	7030003280	S.RESISTOR	ERJ3GEYJ 470 V (47 Ω)	
R225	7030003560	S.RESISTOR	ERJ3GEYJ 103 V (10 kΩ)	
R226	7030003680	S.RESISTOR	ERJ3GEYJ 104 V (100 kΩ)	
R227	7030003800	S.RESISTOR	ERJ3GEYJ 105 V (1 MΩ)	
R228	7030003680	S.RESISTOR	ERJ3GEYJ 104 V (100 kΩ)	
R229	7030003800	S.RESISTOR	ERJ3GEYJ 105 V (1 MΩ)	
R230	7030003660	S.RESISTOR	ERJ3GEYJ 683 V (68 kΩ)	
R231	7030003630	S.RESISTOR	ERJ3GEYJ 393 V (39 kΩ)	
R232	7030003630	S.RESISTOR	ERJ3GEYJ 393 V (39 kΩ)	
R234	7030003550	S.RESISTOR	ERJ3GEYJ 822 V (8.2 kΩ)	
R235	7030003440	S.RESISTOR	ERJ3GEYJ 102 V (1 kΩ)	
R236	7030003450	S.RESISTOR	ERJ3GEYJ 122 V (1.2 kΩ)	
R237	7030003780	S.RESISTOR	ERJ3GEYJ 684 V (680 kΩ)	
R238	7030003680	S.RESISTOR	ERJ3GEYJ 104 V (100 kΩ)	
R240	7030003680	S.RESISTOR	ERJ3GEYJ 104 V (100 kΩ)	
R241	7030003680	S.RESISTOR	ERJ3GEYJ 104 V (100 kΩ)	
R242	7030003630	S.RESISTOR	ERJ3GEYJ 393 V (39 kΩ)	
R243	7030003670	S.RESISTOR	ERJ3GEYJ 823 V (82 kΩ)	
R244	7030003750	S.RESISTOR	ERJ3GEYJ 394 V (390 kΩ)	
R245	7030003710	S.RESISTOR	ERJ3GEYJ 184 V (180 kΩ)	
R247	7030003600	S.RESISTOR	ERJ3GEYJ 223 V (22 kΩ)	
R248	7030003600	S.RESISTOR	ERJ3GEYJ 223 V (22 kΩ)	
R249	7030003600	S.RESISTOR	ERJ3GEYJ 223 V (22 kΩ)	
R250	7030003680	S.RESISTOR	ERJ3GEYJ 104 V (100 kΩ)	
R251	7030003760	S.RESISTOR	ERJ3GEYJ 474 V (470 kΩ)	
R252	7030003400	S.RESISTOR	ERJ3GEYJ 471 V (470 Ω)	
R261	7030003800	S.RESISTOR	ERJ3GEYJ 105 V (1 MΩ)	
R262	7030003800	S.RESISTOR	ERJ3GEYJ 105 V (1 MΩ)	
R263	7030003800	S.RESISTOR	ERJ3GEYJ 105 V (1 MΩ)	
R264	7030003660	S.RESISTOR	ERJ3GEYJ 683 V (68 kΩ)	
R265	7030003590	S.RESISTOR	ERJ3GEYJ 183 V (18 kΩ)	
R266	7030003640	S.RESISTOR	ERJ3GEYJ 473 V (47 kΩ)	
R267	7030003610	S.RESISTOR	ERJ3GEYJ 273 V (27 kΩ)	
R268	7030003560	S.RESISTOR	ERJ3GEYJ 103 V (10 kΩ)	
R269	7030003680	S.RESISTOR	ERJ3GEYJ 104 V (100 kΩ)	
R270	7030003680	S.RESISTOR	ERJ3GEYJ 104 V (100 kΩ)	
R271	7030003320	S.RESISTOR	ERJ3GEYJ 101 V (100 Ω)	
R285	7030003320	S.RESISTOR	ERJ3GEYJ 101 V (100 Ω)	
R287	7030003560	S.RESISTOR	ERJ3GEYJ 103 V (10 kΩ)	
R290	7030003420	S.RESISTOR	ERJ3GEYJ 681 V (680 Ω)	
R291	7030003680	S.RESISTOR	ERJ3GEYJ 104 V (100 kΩ)	
R292	7030003440	S.RESISTOR	ERJ3GEYJ 102 V (1 kΩ)	
R297	7030005651	S.RESISTOR	ERA3YKD 304V (300 kΩ)	
R298	7030005871	S.RESISTOR	ERA3YKD 104V (100 kΩ)	
R304	7030003600	S.RESISTOR	ERJ3GEYJ 223 V (22 kΩ)	
R305	7030003560	S.RESISTOR	ERJ3GEYJ 103 V (10 kΩ)	
R310	7030003550	S.RESISTOR	ERJ3GEYJ 822 V (8.2 kΩ)	
R311	7030003360	S.RESISTOR	ERJ3GEYJ 221 V (220 Ω)	
R312	7030003740	S.RESISTOR	ERJ3GEYJ 334 V (330 kΩ)	
R313	7030003440	S.RESISTOR	ERJ3GEYJ 102 V (1 kΩ)	
R314	7030003440	S.RESISTOR	ERJ3GEYJ 102 V (1 kΩ)	
R315	7030003530	S.RESISTOR	ERJ3GEYJ 562 V (5.6 kΩ)	
R316	7030003600	S.RESISTOR	ERJ3GEYJ 223 V (22 kΩ)	
R317	7030003760	S.RESISTOR	ERJ3GEYJ 474 V (470 kΩ)	
R318	7030003560	S.RESISTOR	ERJ3GEYJ 103 V (10 kΩ)	
R319	7030003680	S.RESISTOR	ERJ3GEYJ 104 V (100 kΩ)	
R320	7030003680	S.RESISTOR	ERJ3GEYJ 104 V (100 kΩ)	
R321	7030003520	S.RESISTOR	ERJ3GEYJ 472 V (4.7 kΩ)	
R322	7030003660	S.RESISTOR	ERJ3GEYJ 683 V (68 kΩ)	
C1	4030011170	S.CERAMIC	GRM31M2C2H180JV01L	
C2	4030011180	S.CERAMIC	GRM31M2C2H220JV01L	(A)
	4030011270	S.CERAMIC	GRM31M2C2H200JV01L	(B)
C3	4030011340	S.CERAMIC	C1608 CH 1H 471J-T	
C4	4030007030	S.CERAMIC	C1608 CH 1H 150J-T	(B)
	4030007040	S.CERAMIC	C1608 CH 1H 180J-T	(A)
C5	4030011340	S.CERAMIC	C1608 CH 1H 471J-T	
C6	4030011180	S.CERAMIC	GRM31M2C2H220JV01L	(A)
	4030011270	S.CERAMIC	GRM31M2C2H200JV01L	(B)
C7	4030011170	S.CERAMIC	GRM31M2C2H180JV01L	(B)
	4030011290	S.CERAMIC	GRM31M2C2H240JV01L	(A)

[MAIN UNIT]

REF NO.	ORDER NO.		DESCRIPTION	
C8	4030011180	S.CERAMIC	GRM31M2C2H220JV01L	(A)
	4030011270	S.CERAMIC	GRM31M2C2H200JV01L	(B)
C9	4030011180	S.CERAMIC	GRM31M2C2H220JV01L	(A)
	4030011270	S.CERAMIC	GRM31M2C2H200JV01L	(B)
C10	4030006860	S.CERAMIC	C1608 JB 1H 102K-T	
C11	4030006860	S.CERAMIC	C1608 JB 1H 102K-T	
C12	4030011340	S.CERAMIC	C1608 CH 1H 471J-T	
C13	4030007090	S.CERAMIC	C1608 CH 1H 470J-T	
C14	4030017200	S.CERAMIC	GRM31BR32J102KY01L	
C15	4030008560	S.CERAMIC	C1608 CH 1H 300J-T	
C17	4030007020	S.CERAMIC	C1608 CH 1H 120J-T	
C18	4030011770	S.CERAMIC	C1608 CH 1H 060B-T	
C19	4030006860	S.CERAMIC	C1608 JB 1H 102K-T	
C20	4030006860	S.CERAMIC	C1608 JB 1H 102K-T	
C21	4030009540	S.CERAMIC	C1608 CH 1H 1R5B-T	
C22	4030009540	S.CERAMIC	C1608 CH 1H 1R5B-T	
C25	4030011770	S.CERAMIC	C1608 CH 1H 060B-T	
C26	4030006860	S.CERAMIC	C1608 JB 1H 102K-T	
C27	4030006860	S.CERAMIC	C1608 JB 1H 102K-T	
C28	4030006860	S.CERAMIC	C1608 JB 1H 102K-T	
C29	4030009910	S.CERAMIC	C1608 CH 1H 040B-T	
C30	4030007010	S.CERAMIC	C1608 CH 1H 100D-T	
C31	4030011600	S.CERAMIC	C1608 JB 1E 104K-T	
C32	4030006860	S.CERAMIC	C1608 JB 1H 102K-T	
C33	4030006860	S.CERAMIC	C1608 JB 1H 102K-T	
C35	4030017490	S.CERAMIC	C1608 JB 1A 105K-T	
C36	4030006860	S.CERAMIC	C1608 JB 1H 102K-T	
C37	4030006860	S.CERAMIC	C1608 JB 1H 102K-T	
C38	4030006860	S.CERAMIC	C1608 JB 1H 102K-T	
C39	4030006860	S.CERAMIC	C1608 JB 1H 102K-T	
C40	4030009540	S.CERAMIC	C1608 CH 1H 1R5B-T	
C41	4030007050	S.CERAMIC	C1608 CH 1H 220J-T	
C42	4030006860	S.CERAMIC	C1608 JB 1H 102K-T	
C43	4030006860	S.CERAMIC	C1608 JB 1H 102K-T	
C44	4030009530	S.CERAMIC	C1608 CH 1H 030B-T	
C45	4030006860	S.CERAMIC	C1608 JB 1H 102K-T	
C48	4030007090	S.CERAMIC	C1608 CH 1H 470J-T	
C49	4030006990	S.CERAMIC	C1608 CH 1H 080D-T	
C50	4030006860	S.CERAMIC	C1608 JB 1H 102K-T	
C51	4030006860	S.CERAMIC	C1608 JB 1H 102K-T	
C52	4030007060	S.CERAMIC	C1608 CH 1H 270J-T	
C53	4030006900	S.CERAMIC	C1608 JB 1H 103K-T	
C54	4030006860	S.CERAMIC	C1608 JB 1H 102K-T	
C55	4030009910	S.CERAMIC	C1608 CH 1H 040B-T	
C56	4030007040	S.CERAMIC	C1608 CH 1H 180J-T	
C57	4030006860	S.CERAMIC	C1608 JB 1H 102K-T	
C58	4030006860	S.CERAMIC	C1608 JB 1H 102K-T	
C59	4030006860	S.CERAMIC	C1608 JB 1H 102K-T	
C60	4030006900	S.CERAMIC	C1608 JB 1H 103K-T	
C61	4030007130	S.CERAMIC	C1608 CH 1H 101J-T	
C62	4030007120	S.CERAMIC	C1608 CH 1H 820J-T	
C63	4030007090	S.CERAMIC	C1608 CH 1H 470J-T	
C64	4030006860	S.CERAMIC	C1608 JB 1H 102K-T	
C65	4030006860	S.CERAMIC	C1608 JB 1H 102K-T	
C66	4030006860	S.CERAMIC	C1608 JB 1H 102K-T	
C67	4030006860	S.CERAMIC	C1608 JB 1H 102K-T	
C68	4030007130	S.CERAMIC	C1608 CH 1H 101J-T	
C69	4030007130	S.CERAMIC	C1608 CH 1H 101J-T	
C70	4030007130	S.CERAMIC	C1608 CH 1H 101J-T	
C71	4030011600	S.CERAMIC	C1608 JB 1E 104K-T	
C72	4030006860	S.CERAMIC	C1608 JB 1H 102K-T	
C73	4030017490	S.CERAMIC	C1608 JB 1A 105K-T	(B)
C74	4030006860	S.CERAMIC	C1608 JB 1H 102K-T	
C75	4550006050	S.TANTALUM	TEMSVA 0J 106M8L	
C76	4030011600	S.CERAMIC	C1608 JB 1E 104K-T	
C77	4030006860	S.CERAMIC	C1608 JB 1H 102K-T	
C78	4030006860	S.CERAMIC	C1608 JB 1H 102K-T	
C79	4030011810	S.CERAMIC	C1608 JB 1A 224K-T	
C80	4030011600	S.CERAMIC	C1608 JB 1E 104K-T	
C81	4030006860	S.CERAMIC	C1608 JB 1H 102K-T	
C82	4030011120	S.CERAMIC	GRM31M2C2H100JV01L	(B)
	4030011270	S.CERAMIC	GRM31M2C2H200JV01L	(A)
C83	4030011120	S.CERAMIC	GRM31M2C2H100JV01L	(B)
	4030011180	S.CERAMIC	GRM31M2C2H220JV01L	(A)
C84	4030007090	S.CERAMIC	C1608 CH 1H 470J-T	
C85	4030006860	S.CERAMIC	C1608 JB 1H 102K-T	
C86	4030007090	S.CERAMIC	C1608 CH 1H 470J-T	
C87	4030006860	S.CERAMIC	C1608 JB 1H 102K-T	
C88	4030006860	S.CERAMIC	C1608 JB 1H 102K-T	
C89	4030007040	S.CERAMIC	C1608 CH 1H 180J-T	
C90	4030009650	S.CERAMIC	C1608 CH 1H 240J-T	
C91	4510005750	S.ELECTROLYTIC	ECEV1EA220SP	

(A): IC-F110S

(B): IC-F120S/F111S

(C): IC-F110S for [EUR]

(D): Narrow/wide version

(E): Narrow/middle version

S.=Surface mount

[MAIN UNIT]

REF NO.	ORDER NO.	DESCRIPTION
C92	4030007030	S.CERAMIC C1608 CH 1H 150J-T
C93	4030007020	S.CERAMIC C1608 CH 1H 120J-T
C94	4030007090	S.CERAMIC C1608 CH 1H 470J-T
C95	4030006860	S.CERAMIC C1608 JB 1H 102K-T
C96	4030006860	S.CERAMIC C1608 JB 1H 102K-T
C97	4030007090	S.CERAMIC C1608 CH 1H 470J-T
C99	4030006860	S.CERAMIC C1608 JB 1H 102K-T
C100	4030007010	S.CERAMIC C1608 CH 1H 100D-T
C102	4030007010	S.CERAMIC C1608 CH 1H 100D-T
C103	4030009530	S.CERAMIC C1608 CH 1H 030B-T
C104	4030006860	S.CERAMIC C1608 JB 1H 102K-T
C105	4030006860	S.CERAMIC C1608 JB 1H 102K-T
C106	4030007090	S.CERAMIC C1608 CH 1H 470J-T
C107	4030006860	S.CERAMIC C1608 JB 1H 102K-T
C108	4030006900	S.CERAMIC C1608 JB 1H 103K-T
C109	4030006860	S.CERAMIC C1608 JB 1H 102K-T
C110	4030011340	S.CERAMIC C1608 CH 1H 471J-T
C111	4030007090	S.CERAMIC C1608 CH 1H 470J-T
C113	4030009560	S.CERAMIC C1608 CH 1H R75B-T
C114	4030007070	S.CERAMIC C1608 CH 1H 330J-T
C115	4030007070	S.CERAMIC C1608 CH 1H 330J-T
C116	4030006900	S.CERAMIC C1608 JB 1H 103K-T
C117	4030011340	S.CERAMIC C1608 CH 1H 471J-T
C118	4030009500	S.CERAMIC C1608 CH 1H 0R5B-T
C119	4030006860	S.CERAMIC C1608 JB 1H 102K-T
C120	4030011340	S.CERAMIC C1608 CH 1H 471J-T
C121	4030007040	S.CERAMIC C1608 CH 1H 180J-T
C122	4030007070	S.CERAMIC C1608 CH 1H 330J-T
C123	4030007110	S.CERAMIC C1608 CH 1H 680J-T
C124	4030011280	S.CERAMIC C1608 CH 1H 271J-T
C126	4030007070	S.CERAMIC C1608 CH 1H 330J-T
C127	4030007030	S.CERAMIC C1608 CH 1H 150J-T
C129	4030009510	S.CERAMIC C1608 CH 1H 010B-T
C131	4030009510	S.CERAMIC C1608 CH 1H 010B-T
C132	4030011600	S.CERAMIC C1608 JB 1E 104K-T
C133	4610001590	S.TRIMMER TZC3R100A110R00
C134	4610001590	S.TRIMMER TZC3R100A110R00
C135	4030006860	S.CERAMIC C1608 JB 1H 102K-T
C136	4030009500	S.CERAMIC C1608 CH 1H 0R5B-T
C138	4030007090	S.CERAMIC C1608 CH 1H 470J-T
C139	4030011600	S.CERAMIC C1608 JB 1E 104K-T
C140	4030011600	S.CERAMIC C1608 JB 1E 104K-T
C141	4030006860	S.CERAMIC C1608 JB 1H 102K-T
C142	4030006860	S.CERAMIC C1608 JB 1H 102K-T
C143	4030006860	S.CERAMIC C1608 JB 1H 102K-T
C144	4030007090	S.CERAMIC C1608 CH 1H 470J-T
C145	4030010760	S.CERAMIC C1608 CH 1H 331J-T
C146	4550006150	S.TANTALUM ECST1CY105R
C147	4550006540	S.TANTALUM ECST1CY475R
C148	4510004630	S.ELECTROLYTIC ECEV1CA100SR
C149	4550006410	S.TANTALUM ECST1VY334R
C151	4030011600	S.CERAMIC C1608 JB 1E 104K-T
C152	4030007090	S.CERAMIC C1608 CH 1H 470J-T
C153	4030007090	S.CERAMIC C1608 CH 1H 470J-T
C154	4030007090	S.CERAMIC C1608 CH 1H 470J-T
C155	4030011280	S.CERAMIC C1608 CH 1H 271J-T
C156	4030007090	S.CERAMIC C1608 CH 1H 470J-T
C157	4030007130	S.CERAMIC C1608 CH 1H 101J-T
C158	4030007130	S.CERAMIC C1608 CH 1H 101J-T
C160	4030007000	S.CERAMIC C1608 CH 1H 090D-T
C161	4030007130	S.CERAMIC C1608 CH 1H 101J-T
C162	4030006900	S.CERAMIC C1608 JB 1H 103K-T
C163	4510004630	S.ELECTROLYTIC ECEV1CA100SR
C164	4030006900	S.CERAMIC C1608 JB 1H 103K-T
C165	4030006900	S.CERAMIC C1608 JB 1H 103K-T
C166	4030006900	S.CERAMIC C1608 JB 1H 103K-T
C167	4030008920	S.CERAMIC C1608 JB 1H 473K-T
C168	4030008920	S.CERAMIC C1608 JB 1H 473K-T
C169	4030008920	S.CERAMIC C1608 JB 1H 473K-T
C170	4030006860	S.CERAMIC C1608 JB 1H 102K-T
C172	4030009630	S.CERAMIC C1608 JB 1H 822K-T
C173	4030011600	S.CERAMIC C1608 JB 1E 104K-T
C174	4510004630	S.ELECTROLYTIC ECEV1CA100SR
C175	4030006860	S.CERAMIC C1608 JB 1H 102K-T
C176	4030007090	S.CERAMIC C1608 CH 1H 470J-T
C177	4030008770	S.CERAMIC C1608 JB 1H 562K-T
C178	4030007160	S.CERAMIC C1608 CH 1H 181J-T
C179	4030011600	S.CERAMIC C1608 JB 1E 104K-T
C180	4510004640	S.ELECTROLYTIC ECEV1CA470SP
C181	4030011600	S.CERAMIC C1608 JB 1E 104K-T
C182	4030008770	S.CERAMIC C1608 JB 1H 562K-T
C183	4030011600	S.CERAMIC C1608 JB 1E 104K-T

[MAIN UNIT]

REF NO.	ORDER NO.	DESCRIPTION
C184	4030009580	S.CERAMIC C1608 JB 1H 681K-T
C200	4030011600	S.CERAMIC C1608 JB 1E 104K-T
C201	4030011600	S.CERAMIC C1608 JB 1E 104K-T
C202	4030011600	S.CERAMIC C1608 JB 1E 104K-T
C203	4030011600	S.CERAMIC C1608 JB 1E 104K-T
C204	4030007090	S.CERAMIC C1608 CH 1H 470J-T
C205	4030007090	S.CERAMIC C1608 CH 1H 470J-T
C206	4030007090	S.CERAMIC C1608 CH 1H 470J-T
C207	4030006860	S.CERAMIC C1608 CH 1H 102K-T
C208	4030006860	S.CERAMIC C1608 JB 1H 102K-T
C209	4030006860	S.CERAMIC C1608 JB 1H 102K-T
C210	4030006860	S.CERAMIC C1608 JB 1H 102K-T
C211	4030007090	S.CERAMIC C1608 CH 1H 470J-T
C213	4030007090	S.CERAMIC C1608 CH 1H 470J-T
C214	4030007090	S.CERAMIC C1608 CH 1H 470J-T
C215	4030007090	S.CERAMIC C1608 CH 1H 470J-T
C216	4030007090	S.CERAMIC C1608 CH 1H 470J-T
C217	4030007090	S.CERAMIC C1608 CH 1H 470J-T
C218	4030007090	S.CERAMIC C1608 CH 1H 470J-T
C219	4030007090	S.CERAMIC C1608 CH 1H 470J-T
C220	4030007090	S.CERAMIC C1608 CH 1H 470J-T
C221	4030007090	S.CERAMIC C1608 CH 1H 470J-T
C222	4030007090	S.CERAMIC C1608 CH 1H 470J-T
C223	4030007090	S.CERAMIC C1608 CH 1H 470J-T
C224	4030007090	S.CERAMIC C1608 CH 1H 470J-T
C225	4030007090	S.CERAMIC C1608 CH 1H 470J-T
C226	4030007090	S.CERAMIC C1608 CH 1H 470J-T
C230	4030007090	S.CERAMIC C1608 CH 1H 470J-T
C231	4030007090	S.CERAMIC C1608 CH 1H 470J-T
C232	4030007090	S.CERAMIC C1608 CH 1H 470J-T
C233	4030007090	S.CERAMIC C1608 CH 1H 470J-T
C244	4030017480	S.CERAMIC C1608 JB 1A 474K-T
C245	4030006900	S.CERAMIC C1608 JB 1H 103K-T
C246	4030011600	S.CERAMIC C1608 JB 1E 104K-T
C248	4030006860	S.CERAMIC C1608 JB 1H 102K-T
C249	4030006870	S.CERAMIC C1608 JB 1H 222K-T
C250	4030011600	S.CERAMIC C1608 JB 1E 104K-T
C251	4030011600	S.CERAMIC C1608 JB 1E 104K-T
C252	4030011600	S.CERAMIC C1608 JB 1E 104K-T
C253	4030008880	S.CERAMIC C1608 JB 1H 223K-T
C254	4030006860	S.CERAMIC C1608 JB 1H 102K-T
C255	4510008030	S.ELECTROLYTIC ECEV1EA471P
C256	4510006260	S.ELECTROLYTIC ECEV1AA471UP
C258	4510008030	S.ELECTROLYTIC ECEV1EA471P
C259	4030006860	S.CERAMIC C1608 JB 1H 102K-T
C260	4030007090	S.CERAMIC C1608 CH 1H 470J-T
C261	4030004760	S.CERAMIC C2012 JF 1H 104Z-T
C262	4030011600	S.CERAMIC C1608 JB 1E 104K-T
C263	4030004760	S.CERAMIC C2012 JF 1H 104Z-T
C264	4030011600	S.CERAMIC C1608 JB 1E 104K-T
C265	4510008030	S.ELECTROLYTIC ECEV1EA471P
C266	4510004630	S.ELECTROLYTIC ECEV1CA100SR
C268	4550006700	S.TANTALUM ECST1AY106R
C269	4030006860	S.CERAMIC C1608 JB 1H 102K-T
C270	4030006860	S.CERAMIC C1608 JB 1H 102K-T
C271	4510004630	S.ELECTROLYTIC ECEV1CA100SR
C272	4510004630	S.ELECTROLYTIC ECEV1CA100SR
C273	4030006860	S.CERAMIC C1608 JB 1H 102K-T
C274	4510004630	S.ELECTROLYTIC ECEV1CA100SR
C275	4030006860	S.CERAMIC C1608 JB 1H 102K-T
C276	4030006860	S.CERAMIC C1608 JB 1H 102K-T
C280	4030006900	S.CERAMIC C1608 JB 1H 103K-T
C282	4030011600	S.CERAMIC C1608 JB 1E 104K-T
C283	4030006860	S.CERAMIC C1608 JB 1H 102K-T
C286	4030006900	S.CERAMIC C1608 JB 1H 103K-T
C287	4030008650	S.CERAMIC C1608 JB 1H 332K-T
C288	4030011600	S.CERAMIC C1608 JB 1E 104K-T
C289	4030011600	S.CERAMIC C1608 JB 1E 104K-T
C290	4030006860	S.CERAMIC C1608 JB 1H 102K-T
C291	4030006860	S.CERAMIC C1608 JB 1H 102K-T
C292	4030007090	S.CERAMIC C1608 CH 1H 470J-T
C293	4030006860	S.CERAMIC C1608 JB 1H 102K-T
C294	4030006860	S.CERAMIC C1608 JB 1H 102K-T
C295	4510004630	S.ELECTROLYTIC ECEV1CA100SR
C297	4030007050	S.CERAMIC C1608 CH 1H 220J-T
C298	4030007020	S.CERAMIC C1608 CH 1H 120J-T
C299	4030007020	S.CERAMIC C1608 CH 1H 120J-T
C300	4030007010	S.CERAMIC C1608 CH 1H 100D-T
C301	4030006860	S.CERAMIC C1608 JB 1H 102K-T
C302	4030007010	S.CERAMIC C1608 CH 1H 100D-T
C303	4030006860	S.CERAMIC C1608 JB 1H 102K-T
C304	4030007010	S.CERAMIC C1608 CH 1H 100D-T

Ⓐ: IC-F110S
 Ⓒ: IC-F110S for [EUR]
 Ⓔ: Narrow/middle version

Ⓑ: IC-F120S/F111S
 Ⓓ: Narrow/wide version

S.=Surface mount

[MAIN UNIT]

REF NO.	ORDER NO.	DESCRIPTION	
C305	4030007100	S.CERAMIC	C1608 CH 1H 560J-T
C306	4030009910	S.CERAMIC	C1608 CH 1H 040B-T
C307	4030006980	S.CERAMIC	C1608 CH 1H 070D-T
C308	4030009530	S.CERAMIC	C1608 CH 1H 030B-T
C309	4030006900	S.CERAMIC	C1608 JB 1H 103K-T
C310	4030006860	S.CERAMIC	C1608 JB 1H 102K-T
C311	4030006860	S.CERAMIC	C1608 JB 1H 102K-T
C312	4030011600	S.CERAMIC	C1608 JB 1E 104K-T
C314	4030006900	S.CERAMIC	C1608 JB 1H 103K-T
C315	4030008880	S.CERAMIC	C1608 JB 1H 223K-T
C316	4030009490	S.CERAMIC	C1608 JB 1H 821K-T
C317	4030009490	S.CERAMIC	C1608 JB 1H 821K-T
C318	4030011600	S.CERAMIC	C1608 JB 1E 104K-T
C320	4030008910	S.CERAMIC	C1608 JB 1H 393K-T
C321	4030011600	S.CERAMIC	C1608 JB 1E 104K-T
C322	4030006900	S.CERAMIC	C1608 JB 1H 103K-T
C324	4030011340	S.CERAMIC	C1608 CH 1H 471J-T
C325	4030006860	S.CERAMIC	C1608 JB 1H 102K-T
C327	4510004630	S.ELECTROLYTIC	ECEV1CA100SR
C330	4550006170	S.TANTALUM	ECST1AY225R
C331	4030006860	S.CERAMIC	C1608 JB 1H 102K-T
C332	4550006700	S.TANTALUM	ECST1AY106R
C333	4030007090	S.CERAMIC	C1608 CH 1H 470J-T
C335	4030006860	S.CERAMIC	C1608 JB 1H 102K-T
C337	4030006860	S.CERAMIC	C1608 JB 1H 102K-T
C339	4030009550	S.CERAMIC	C1608 CH 1H 2R5B-T
C342	4550006410	S.TANTALUM	ECST1VY334R
C343	4030006900	S.CERAMIC	C1608 JB 1H 103K-T
C348	4030006860	S.CERAMIC	C1608 JB 1H 102K-T
C349	4030011600	S.CERAMIC	C1608 JB 1E 104K-T
C350	4030017490	S.CERAMIC	C1608 JB 1A 105K-T
C351	4030008920	S.CERAMIC	C1608 JB 1H 473K-T
C352	4510005750	S.ELECTROLYTIC	ECEV1EA220SP
C353	4030006980	S.CERAMIC	C1608 CH 1H 070D-T
C355	4030011770	S.CERAMIC	C1608 CH 1H 060B-T
C356	4030011770	S.CERAMIC	C1608 CH 1H 060B-T
C357	4030011600	S.CERAMIC	C1608 JB 1E 104K-T
C359	4030017490	S.CERAMIC	C1608 JB 1A 105K-T
C360	4030011770	S.CERAMIC	C1608 CH 1H 060B-T
C361	4030006860	S.CERAMIC	C1608 JB 1H 102K-T
C362	4030011600	S.CERAMIC	C1608 JB 1E 104K-T
C363	4030006860	S.CERAMIC	C1608 JB 1H 102K-T
C364	4030006900	S.CERAMIC	C1608 JB 1H 103K-T
C365	4030009540	S.CERAMIC	C1608 CH 1H 1R5B-T
C366	4030009530	S.CERAMIC	C1608 CH 1H 030B-T
C367	4030011600	S.CERAMIC	C1608 JB 1E 104K-T
C368	4030007130	S.CERAMIC	C1608 CH 1H 101J-T
C370	4030007130	S.CERAMIC	C1608 CH 1H 101J-T
C375	4030009570	S.CERAMIC	C1608 CH 1H 0R3B-T
C376	4030006860	S.CERAMIC	C1608 JB 1H 102K-T
C390	4030011170	S.CERAMIC	GRM31M2C2H180JV01L
C392	4030011120	S.CERAMIC	GRM31M2C2H100JV01L
C393	4030011120	S.CERAMIC	GRM31M2C2H100JV01L
C401	4030011340	S.CERAMIC	C1608 CH 1H 471J-T
C402	4030011340	S.CERAMIC	C1608 CH 1H 471J-T
C405	4030006860	S.CERAMIC	C1608 JB 1H 102K-T
C406	4030011340	S.CERAMIC	C1608 CH 1H 471J-T
C407	4030007090	S.CERAMIC	C1608 CH 1H 470J-T
C408	4030006860	S.CERAMIC	C1608 JB 1H 102K-T
C409	4030007090	S.CERAMIC	C1608 CH 1H 470J-T
C410	4030007090	S.CERAMIC	C1608 CH 1H 470J-T
C411	4030011340	S.CERAMIC	C1608 CH 1H 471J-T
C412	4030006860	S.CERAMIC	C1608 JB 1H 102K-T
C413	4030011340	S.CERAMIC	C1608 CH 1H 471J-T
C424	4030007130	S.CERAMIC	C1608 CH 1H 101J-T
C426	4030007130	S.CERAMIC	C1608 CH 1H 101J-T
C427	4030007170	S.CERAMIC	C1608 CH 1H 221J-T
C428	4030007130	S.CERAMIC	C1608 CH 1H 101J-T
C429	4030010240	S.CERAMIC	C1608 JB 1H 391K-T
C430	4030006860	S.CERAMIC	C1608 JB 1H 102K-T
C431	4030007130	S.CERAMIC	C1608 CH 1H 101J-T
C432	4030007130	S.CERAMIC	C1608 CH 1H 101J-T
C433	4030007130	S.CERAMIC	C1608 CH 1H 101J-T
J1	6510018430	S.CONNECTOR	AXN330C038P
J2	6510022470	S.CONNECTOR	40FLT-SM1-TB
J4	6450000140	CONNECTOR	HSJ0807-01-010
J6	6510019250	S.CONNECTOR	B11B-ZR-SM3-TF
J7	6510014960	S.CONNECTOR	B2B-ZR-SM3-TF

Ⓐ: IC-F110S

Ⓒ: IC-F110S for [EUR]

Ⓔ: Narrow/middle version

Ⓑ: IC-F120S/F111S

Ⓓ: Narrow/wide version

[MAIN UNIT]

REF NO.	ORDER NO.	DESCRIPTION	
W1	7120000470	JUMPER	ERDS2T0
W2	8900011861	CABLE	OPC-1195A
W4	7030003860	S.JUMPER	ERJ3GE JPW V
W5	7030003860	S.JUMPER	ERJ3GE JPW V
EP1	6910013370	S.BEAD	BLM18BB221SN1D
EP2	6910011560	BEAD	HF70BB4.5X5X1.6
EP3	6910011560	BEAD	HF70BB4.5X5X1.6
EP4	6910010280	BEAD	HF70BB9.5X10.4X4.9
EP5	6910010280	BEAD	HF70BB9.5X10.4X4.9
EP6	0910055545	PCB	B 5873E

S.=Surface mount

SECTION 7 MECHANICAL PARTS

[CHASSIS PARTS]

REF. NO.	ORDER NO.	DESCRIPTION	QTY.
J1	6510004880	Connector MR-DS-E 01	1
MP1	8010019060	2601 chassis [25W]	1
	8010019130	2601 long chassis [50W]	1
MP2	8110007820	2601 cover	1
MP3	8810008660	Screw PH BT M3 × 8 NI-ZU	8
MP4	8810008660	Screw PH BT M3 × 8 NI-ZU	2
MP5	8810008660	Screw PH BT M3 × 8 NI-ZU	2
MP6	8810008660	Screw PH BT M3 × 8 NI-ZU	1
MP7	8810009990	Screw PH BT M3 × 8 ZK	4
MP8	8810009990	Screw PH BT M3 × 8 ZK	2
MP10	8930058990	Shield sponge (V) [EUR] only	1

[FRONT UNIT]

REF. NO.	ORDER NO.	DESCRIPTION	QTY.
R14	7210003020	Variable resistor EVU-F2KFK1B14	1
SP1	2510001220	Speaker C052SB500-13	1
J1	6450002210	Connector 3017-8821	1
W1	8900010500	Cable OPC-1046	1
MP1	8210019080	2601 front panel	1
MP2	8930058340	2601 front key	1
MP3	8310054410	2601 front plate	1
MP4	8210019090	2601 reflector	1
MP5	8610011180	Knob N292	1
MP6	8610007420	Knob spring No.6601	1
MP7	8810008660	Screw PH BT M3 × 8 NI-ZU	2
MP8	8510014930	2601 earth plate	1
MP9	8930059000	2601 SP net	1
MP10	8810008660	Screw PH BT M3 × 8 NI-ZU	2

[MAIN UNIT]

REF. NO.	ORDER NO.	DESCRIPTION	QTY.
J4	6450000140	Connector HSJ0807-01-010	1
W2	8900011861	Cable OPC-1195A	1
MP1	8510002280	VCO shield plate (A)	1
MP2	8930058840	Shield sponge (T) [25W] only	1
MP3	8930058840	Shield sponge (T) [USA],[GEN] only	1
MP4	8510014940	2601 VCO case	1
MP5	8510014950	2601 VCO cover	1
MP6	8510014910	2601 filter case	1
MP7	8510014920	2601 M-plate [25W-GEN]	1
	8510015110	2602 M-plate [Other]	1
MP9	8930058990	Shield sponge (V)	1
MP10	8930059380	Shield sponge (X) [EUR] only	1

[ACCESSORIES]

REF. NO.	ORDER NO.	DESCRIPTION	QTY.
MC1	0800005780	Microphone HM-100N	1
W1	8900011780	Cable OPC-1194 [25W]	1
	8900010990	Cable OPC-1132 [50W]	1
W2	8900000730	Cable OPC-049	1
MP1	8010019151	2601 mobil bracket-1	1
MP2	8930059160	2601 felt	2
MP3	8820000530	Flange volt M4 × 8 NI	4
MP4	8810000470	Screw PH M5 × 12 (+-)	4
MP5	8810005840	Screw PH A M5 × 20	4
MP6	8850000150	Flat washer M5 NI BS	4
MP7	8850000390	Spring washer M5	4
MP8	8830000120	Nut M5	4
MP9	6910004210	731 mic hanger set	1
MP10	8310054770	1705 LCD seal (F)	1

Screw abbreviations A,BT: Self-tapping PH: Pan head
 ZK: Black BS: Brass
 NI: Nickel NI-ZU: Nickel-Zinc

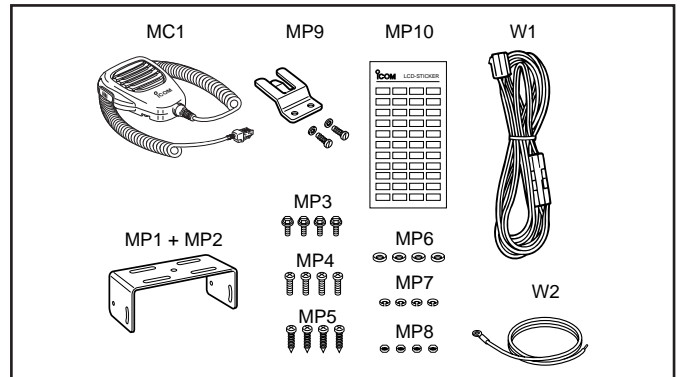

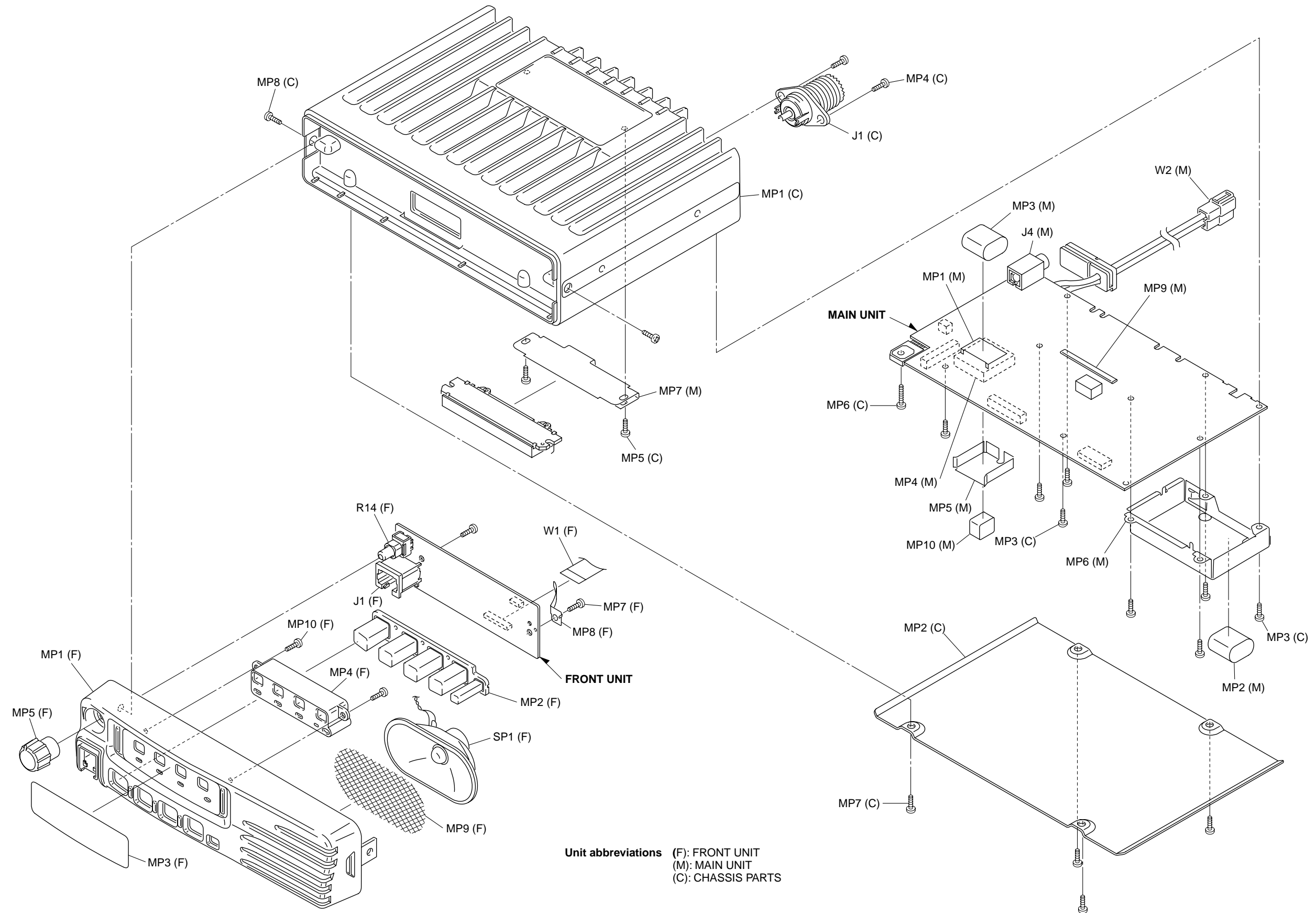





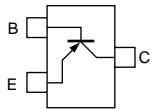
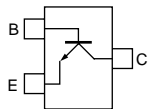
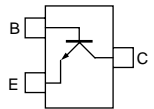
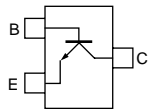
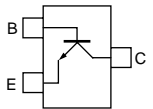
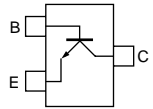
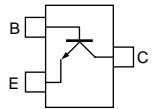
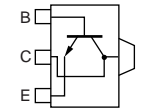
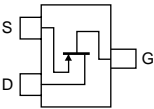
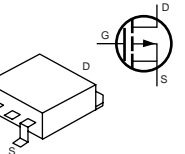
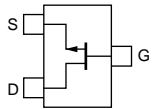
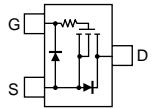
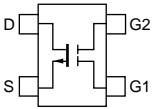
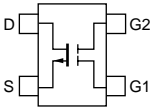
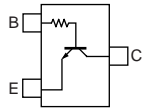
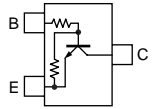
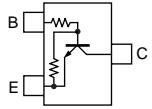
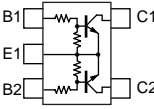
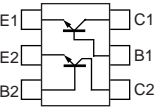

SECTION 8 SEMI-CONDUCTOR INFORMATION

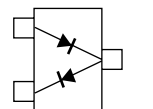
• TRANSISTORS AND FET'S

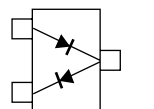
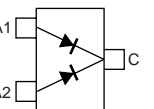
2SA1577 T106 Q (Symbol: HQ) 	2SC3356 T1B R25 (Symbol: R25) 	2SC4081 T106 R (Symbol: BR) 	2SC4116 BL (Symbol: LL) 	2SC4215 O (Symbol: QO) 
2SC4226 T1 R25 (Symbol: R25) 	2SC5107 O (Symbol: MFO) 	2SD1664 T100Q (Symbol: DAQ) 	2SJ144 GR (Symbol: VG) 	2SJ377 (Symbol: 4L) 
2SK880 Y (Symbol: XY) 	2SK1829 (Symbol: K1) 	3SK293 (Symbol: UF) 	3SK299 T1 U73 (Symbol: U73) 	DTC114TUA T106 (Symbol: 04) 
DTC144EUA T106 (Symbol: 26) 	DTC363 EK (Symbol: H27) 	XP1214 (Symbol: 9H) 	XP6501 AB (Symbol: 5N) 	

• DIODES

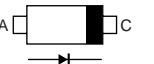
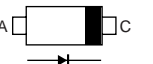
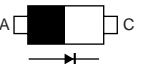
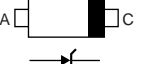
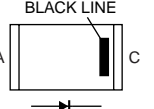
1SS375-TL (Symbol: FH) 	1SV239 (Symbol: TC) 	DA221 TL (Symbol: K) 	DAN222TL (Symbol: N) 	HVC350B (Symbol: B0) 
HVC362 (Symbol: V2) 	HVC375B (Symbol: B8) 	HVC376B (Symbol: B9) 	MA2S111 (Symbol: A) 	MA2S728 (Symbol: B) 
MA77 (Symbol: 4B) 	MA8056 M (Symbol: 5-6) 	UM9401F (Symbol: none) 		

SECTION 9 BOARD LAYOUTS

9-1 FRONT UNIT • TOP VIEW

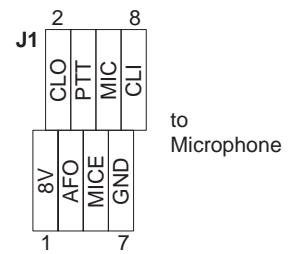
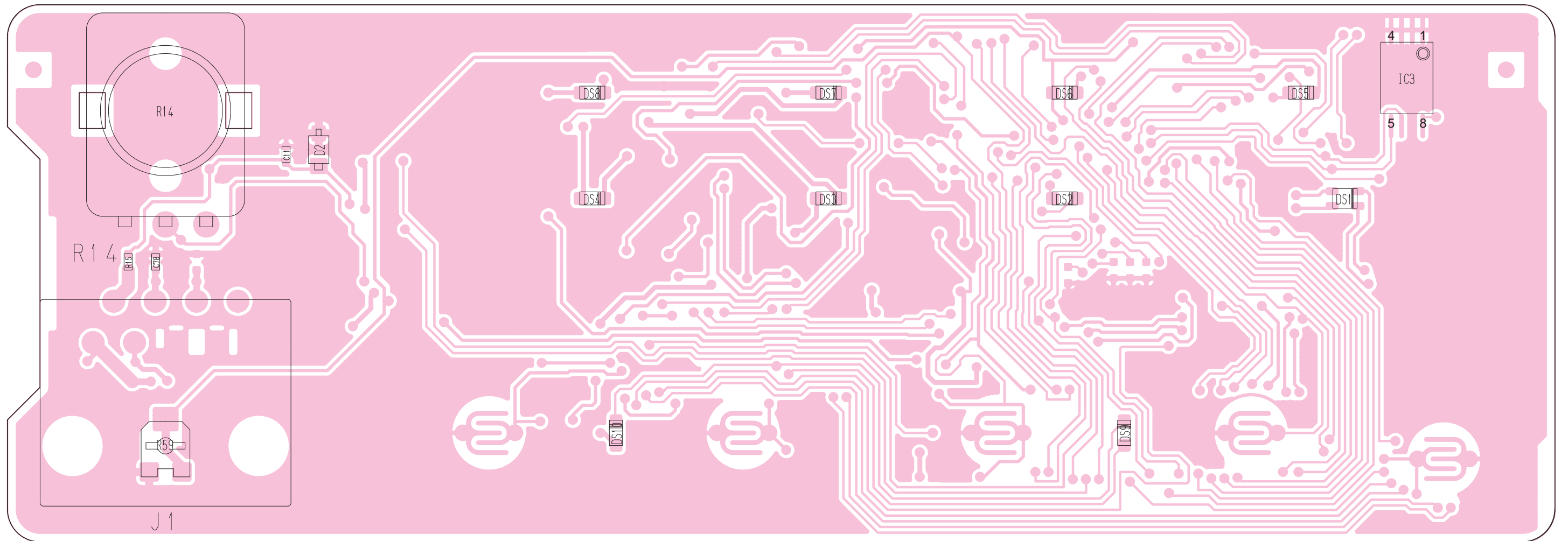

• BOTTOM VIEW (FRONT UNIT)

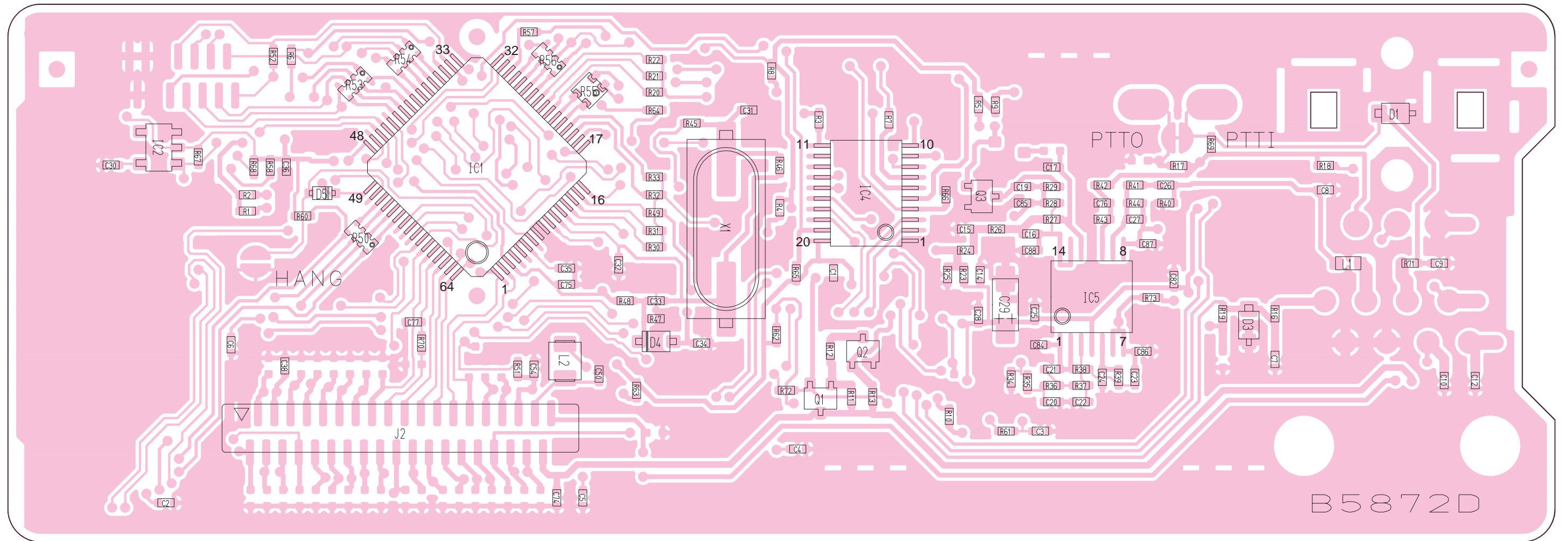

1	GND	39
2	DIM	GND
3	TONE	8V
4	TENC	5V
5	NOIS	BEEP
6	NWC	AFON
7	TMUT	CPU5
8	UNLK	AFO
9	PLST	
10	CDEC	
11	SCK	
12	SI	
13	SO	
14	OV12	
15	SSSI	
16	LVIN	
17	TEMP	
18	BATV	
19	RXC	
20	HORNO	
21	BEEP	
22	PWON	
23	8V	
24	GND	
25		
26		
27		
28		
29		
30		
31		
32		
33		
34		
35		
36		
37		
38		
40		

to MAIN unit J2

• BOTTOM VIEW (MAIN UNIT)

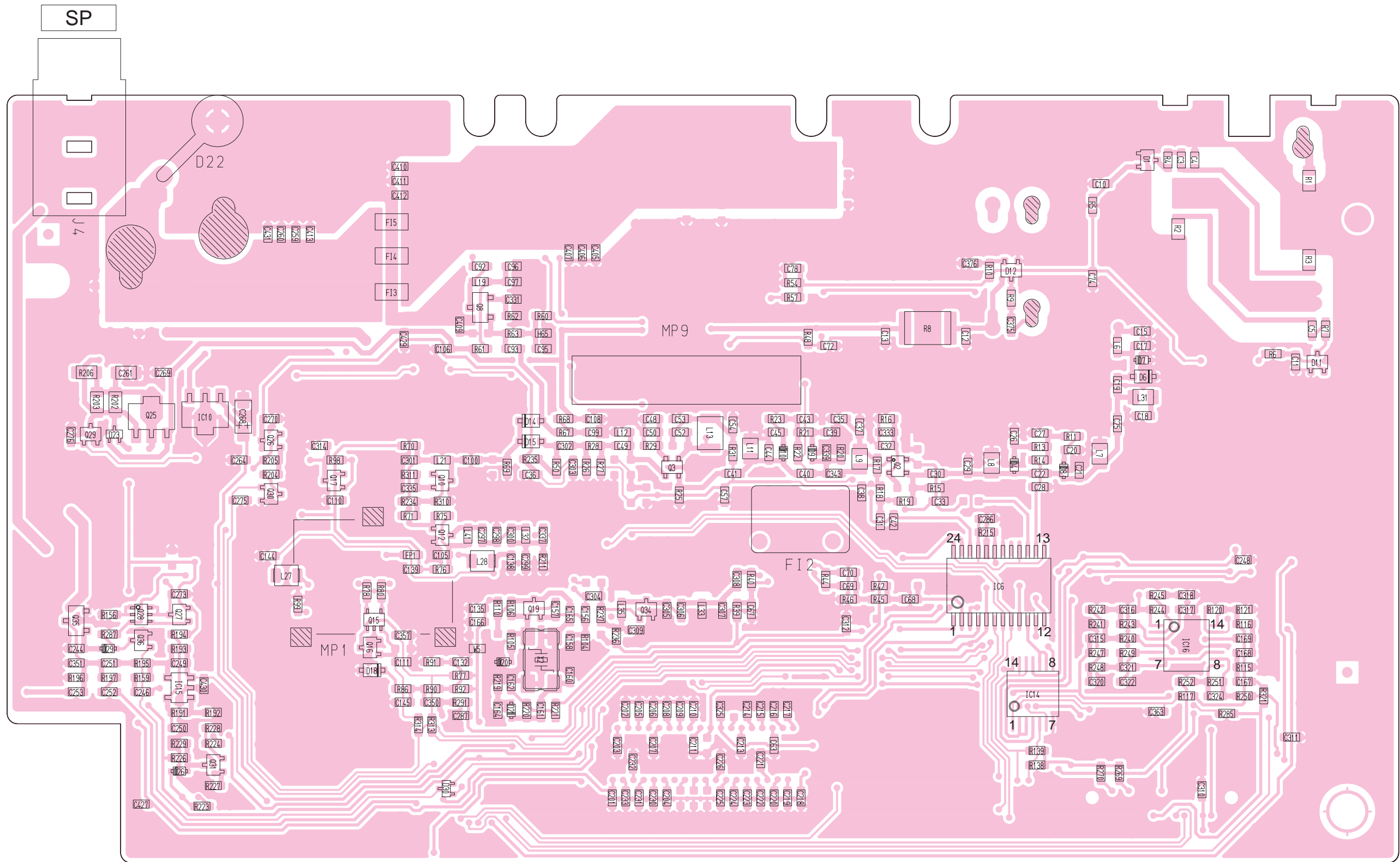

SECTION 10 BLOCK DIAGRAM

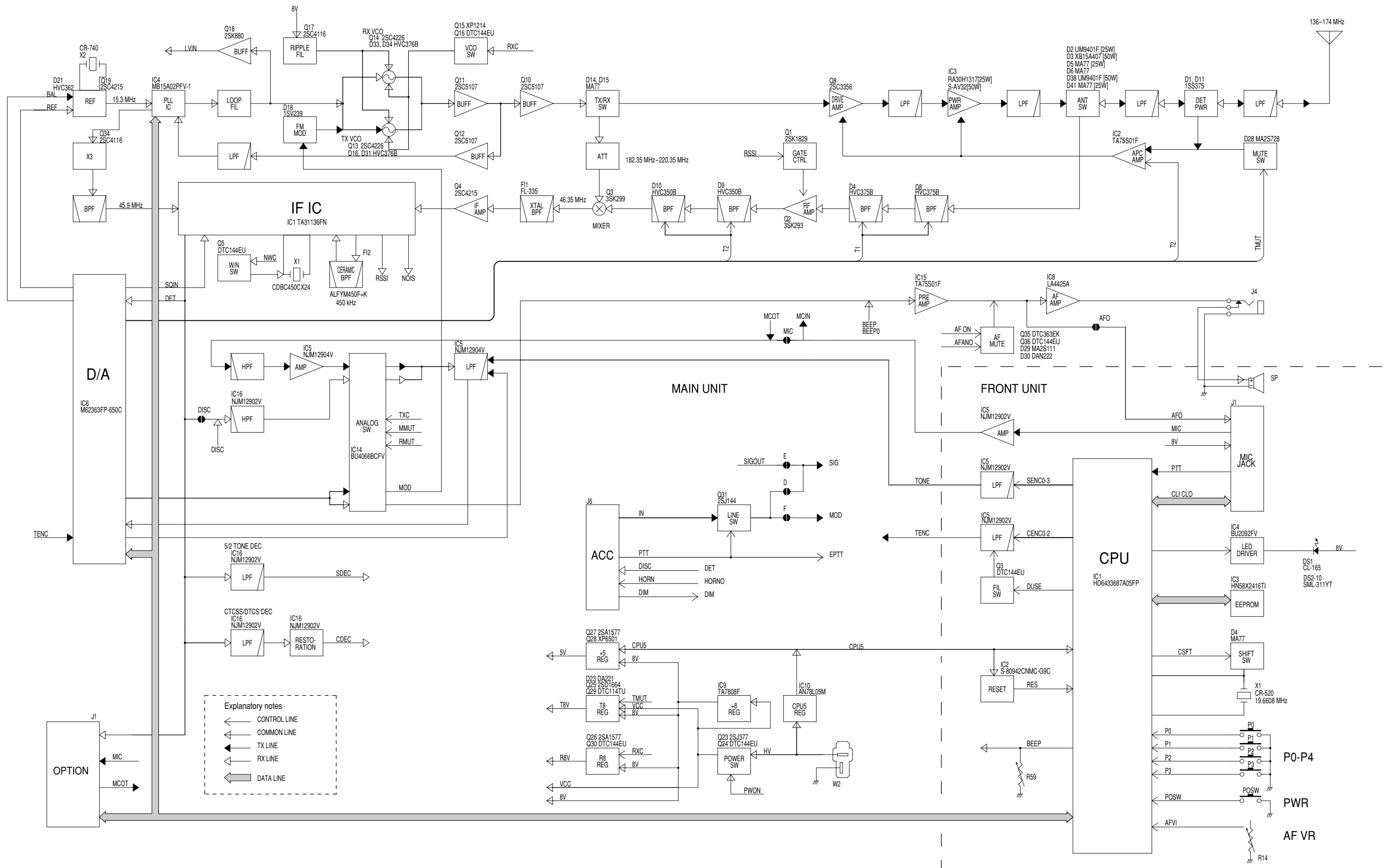

SECTION 11 VOLTAGE DIAGRAMS

11-1 FRONT UNIT

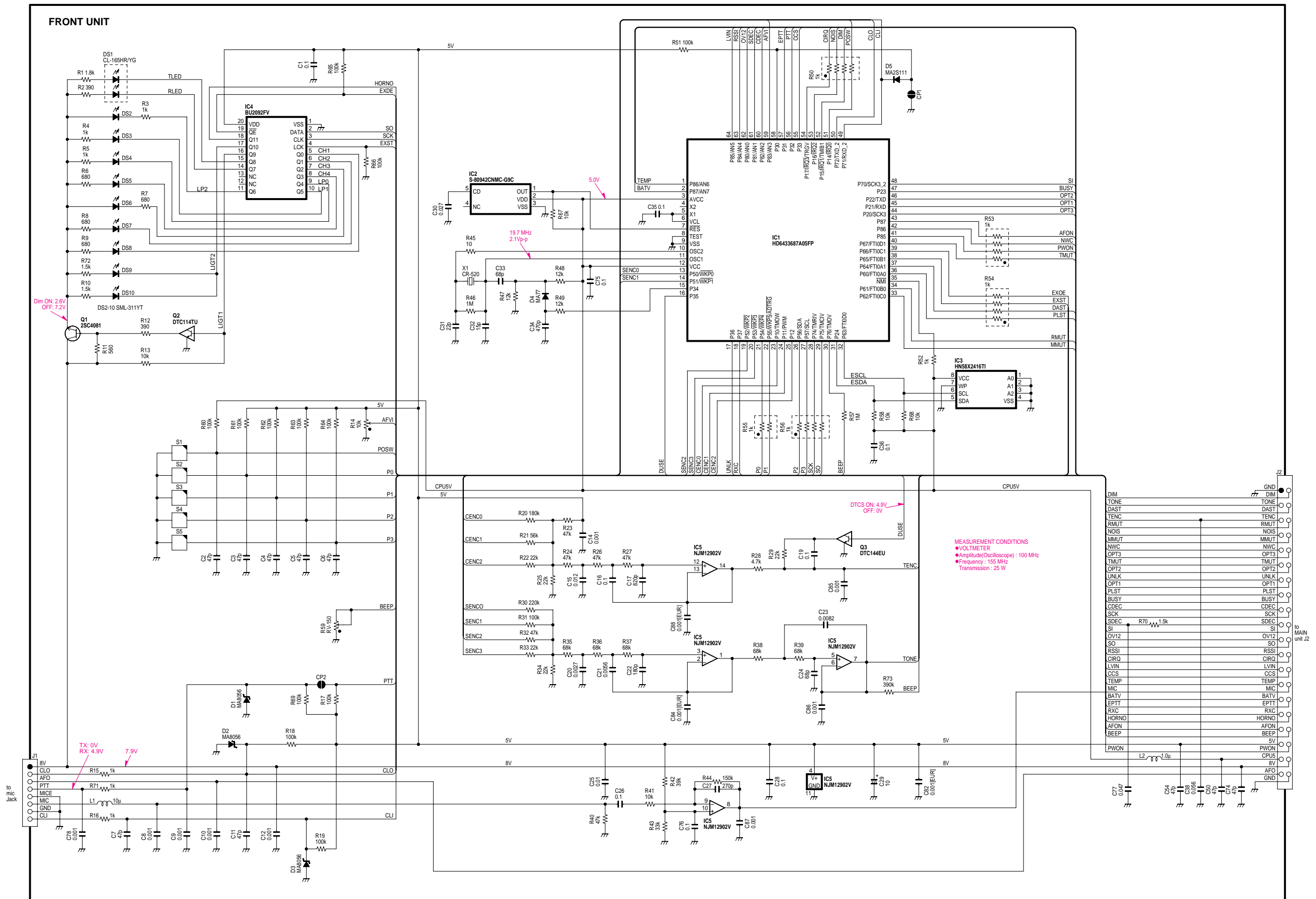

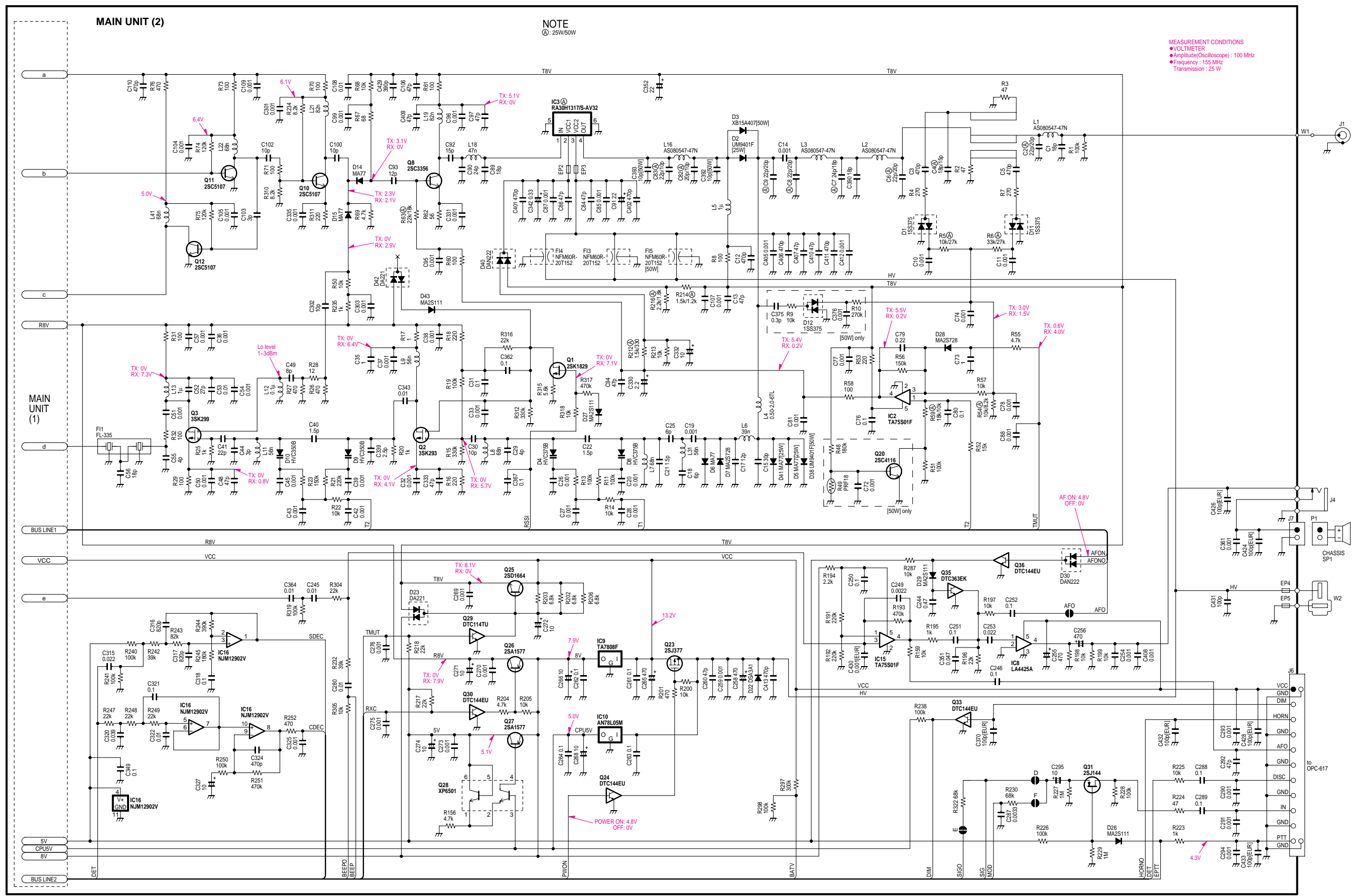

NOTE
 Ⓢ: 25W/50W

MEASUREMENT CONDITIONS
 ● VOLTMETER
 ● Amplitude(Oscilloscope) : 100 MHz
 ● Frequency : 155 MHz
 ● Transmission : 25 W

Icom Inc.

1-1-32, Kamiminami, Hirano-ku, Osaka 547-0003, Japan
Phone : 06 6793 5302
Fax : 06 6793 0013
URL : <http://www.icom.co.jp/world/index.html>

Icom America Inc.

<Corporate Headquarters>
2380 116th Avenue N.E., Bellevue, WA 98004, U.S.A.
Phone : (425) 454-8155 Fax : (425) 454-1509
URL : <http://www.icomamerica.com>
<Customer Service>
Phone : (425) 454-7619

Icom Canada

Glenwood Centre #150-6165
Highway 17 Delta, B.C., V4K 5B8, Canada
Phone : (604) 952-4266 Fax : (604) 952-0090
URL : <http://www.icomcanada.com>

Icom (Australia) Pty. Ltd.

A.B.N. 88 006 092 575
290-294 Albert Street, Brunswick, Victoria, 3056, Australia
Phone : 03 9387 0666 Fax : 03 9387 0022
URL : <http://www.icom.net.au>

Icom New Zealand

146A Harris Road, East Tamaki,
Auckland, New Zealand
Phone : 09 274 4062 Fax : 09 274 4708
URL : <http://www.icom.co.nz>

Beijing Icom Ltd.

1305, Wanshang Plaza, Shijingshan Road, Beijing China
Phone : (010) 6866 6337 Fax : (010) 6866 3553
URL : <http://www.bjicom.com>

Icom (Europe) GmbH

Communication Equipment
Himmelgeister Str. 100, D-40225 Düsseldorf, Germany
Phone : 0211 346047 Fax : 0211 333639
URL : <http://www.icomeurope.com>

Icom Spain S.L

Crta. de Gracia a Manresa Km. 14,750
08190 Sant Cugat del Valles Barcelona, SPAIN
Phone : (93) 590 26 70 Fax : (93) 589 04 46
URL : <http://www.icomspain.com>

Icom (UK) Ltd.

Unit 9, Sea St., Herne Bay, Kent, CT6 8LD, U.K.
Phone : 01227 741741 Fax : 01227 741742
URL : <http://www.icomuk.co.uk>

Icom France S.a

Zac de la Plaine, 1, Rue Brindejonc des Moulinais
BP 5804, 31505 Toulouse Cedex, France
Phone : (33) 5 61 36 03 03 Fax : (33) 5 61 36 03 00
URL : <http://www.icom-france.com>

Asia Icom Inc.

6F No. 68, Sec. 1 Cheng-Teh Road, Taipei, Taiwan, R.O.C.
Phone : (02) 2559 1899 Fax : (02) 2559 1874
URL : <http://www.asia-icom.com>

Count on us!

Icom Inc.

1-1-32, Kamiminami, Hirano-ku, Osaka 547-0003, Japan

S-13906HZ-C1VS-③

© 2003 Icom Inc.



SERVICE MANUAL

UHF TRANSCEIVER

IC-F210S
IC-F211S
IC-F221S

INTRODUCTION

This service manual describes the latest service information for the **IC-F210S, IC-F211S and IC-F221S** UHF MOBILE TRANSCEIVER at the time of publication.

MODEL	VERSION	SYMBOL
IC-F210S	Europe	EUR
	General	GEN
IC-F211S	General	GEN
IC-F221S	U.S.A.	USA

To upgrade quality, any electrical or mechanical parts and internal circuits are subject to change without notice or obligation.

DANGER

NEVER connect the transceiver to an AC outlet or to a DC power supply that uses more than 16 V. This will ruin the transceiver.

DO NOT expose the transceiver to rain, snow or any liquids.

DO NOT reverse the polarities of the power supply when connecting the transceiver.

DO NOT apply an RF signal of more than 20 dBm (100 mW) to the antenna connector. This could damage the transceiver's front end.



ORDERING PARTS

Be sure to include the following four points when ordering replacement parts:

1. 10-digit order numbers
2. Component part number and name
3. Equipment model name and unit name
4. Quantity required

<SAMPLE ORDER>

1110003490 S.IC TA31136FN IC-F210S MAIN UNIT 5 pieces
8810009990 Screw PH BT M3x8 ZK IC-F210S Bottom cover 10 pieces

Addresses are provided on the inside back cover for your convenience.

REPAIR NOTES

1. Make sure a problem is internal before disassembling the transceiver.
2. **DO NOT** open the transceiver until the transceiver is disconnected from its power source.
3. **DO NOT** force any of the variable components. Turn them slowly and smoothly.
4. **DO NOT** short any circuits or electronic parts. An insulated tuning tool **MUST** be used for all adjustments.
5. **DO NOT** keep power ON for a long time when the transceiver is defective.
6. **DO NOT** transmit power into a signal generator or a sweep generator.
7. **ALWAYS** connect a 40 dB to 50 dB attenuator between the transceiver and a deviation meter or spectrum analyzer when using such test equipment.
8. **READ** the instructions of test equipment thoroughly before connecting equipment to the transceiver.

EXPLICIT DEFINITIONS

FREQUENCY COVERAGE

Low Band	400–430 MHz
High Band	440–490 MHz

CHANNEL SPACING

Narrow/Wide-type	12.5 kHz/ 25.0 kHz
Narrow/Middle-type	12.5 kHz/ 20.0 kHz

TABLE OF CONTENTS

SECTION 1	SPECIFICATIONS	
SECTION 2	INSIDE VIEW	
SECTION 3	DISASSEMBLY INSTRUCTIONS	
SECTION 4	CIRCUIT DESCRIPTION	
4 - 1	RECEIVER CIRCUITS	4 - 1
4 - 2	TRANSMITTER CIRCUITS	4 - 2
4 - 3	PLL CIRCUITS	4 - 3
4 - 4	POWER SUPPLY CIRCUITS	4 - 4
4 - 5	PORT ALLOCATIONS	4 - 4
SECTION 5	ADJUSTMENT PROCEDURES	
5 - 1	PREPARATION	5 - 1
5 - 2	PLL ADJUSTMENT	5 - 4
5 - 3	SOFTWARE ADJUSTMENT	5 - 5
5 - 4	TRIMMER ADJUSTMENT	5 - 7
SECTION 6	PARTS LIST	
SECTION 7	MECHANICAL PARTS	
SECTION 8	SEMI-CONDUCTOR INFORMATION	
SECTION 9	BOARD LAYOUTS	
9 - 1	FRONT UNIT	9 - 1
9 - 2	MAIN UNIT	9 - 3
SECTION 10	BLOCK DIAGRAM	
SECTION 11	VOLTAGE DIAGRAMS	
11 - 1	FRONT UNIT	11 - 1
11 - 2	MAIN UNIT	11 - 2

SECTION 1 SPECIFICATIONS

		[GEN], [USA]	[EUR]	
GENERAL	Measurement method	EIA-152-C/204D or TIA-603	EN 300 086	
	Frequency coverage	400.000–430.000 MHz 440.000–490.000 MHz		
	Type of emission	N/W: (12.5 kHz; Narrow/25 kHz; Wide): 8K50F3E/16K0F3E (12.5 kHz; Narrow/25 kHz; Wide): 11K0F3E/16K0F3E N/M: (12.5 kHz; Narrow/20 kHz; Middle): 8K50F3E/14K0F3E	[EUR] [USA], [GEN] [EUR]	
	Number of conventional channels	Free: 8 channels, Bank: 4 channels × 2 banks		
	Power supply voltage (negative ground)	13.6 V DC nominal	13.2 V DC nominal	
	Current drain (approx.)	TX 7.0 A (at 25 W), 13.0 A (at 45 W) RX 1200 mA (maximum audio) 300 mA (stand-by)		
	Antenna impedance	50 Ω nominal (SO-239)		
	Usable temperature range	–30°C to +60°C (–22°F to +140°F)	–25°C to +55°C (–13°F to +131°F)	
	Dimensions (proj. not included)	150(W) × 40(H) × 117.5(D) mm; 5 ²⁹ / ₃₂ (W) × 1 ⁹ / ₁₆ (H) × 4 ⁵ / ₈ (D) inch 150(W) × 40(H) × 167.5(D) mm; 5 ²⁹ / ₃₂ (W) × 1 ⁹ / ₁₆ (H) × 6 ¹⁹ / ₃₂ (D) inch	[25 W] [45 W]	
	Weight	0.8 kg; 1 lb 12 oz [25 W], 1.1 kg; 2 lb 7 oz [45 W]		
TRANSMITTER	RF output power	High/Low2/Low1: 25 W/10 W/2.5 W 50 W/25 W/4.5 W	[25 W] [45 W]	
	Modulation system	Variable reactance frequency modulation		
	Maximum permissible deviation	±2.5 kHz [Narrow], ±4.0 kHz [Middle], ±5.0 kHz [Wide]		
	Frequency error	±2.5 ppm	±1.5 kHz	
	Spurious emissions	70 dBc typical	0.25 μW ≤ 1GHz, 1.0 μW > 1 GHz	
	Adjacent channel power	60 dB [Narrow], 70 dB [Middle], [Wide]		
	Audio frequency response	+2 dB to –8 dB of 6 dB/octave range from 300 Hz to 2550 Hz [Narrow]/3000 Hz [Middle], [Wide]		
	Audio harmonic distortion	3% typical at 1 kHz, 40% deviation		
	FM hum and noise (typical) (without CCICT filter)	40 dB [Narrow], 46 dB [Wide]	—	
	Residual modulation (typical) (with CCICT filter)	—	50 dB [Narrow], 53 dB [Middle] 55 dB [Wide]	
	Limiting charact of modulator	70–100% of max. deviation		
	Microphone connector	8-pin modular (600 Ω)		
RECEIVER	Receive system	Double-conversion superheterodyne system		
	Intermediate frequencies	1st: 46.35 MHz, 2nd: 450 kHz		
	Sensitivity (typical)	0.25 μV at 12 dB SINAD	–4 dBμV (emf) at 20 dB SINAD	
	Squelch sencitivity (at threshold) (typical)	0.25 μV	–4 dBμV (emf)	
	Adjacent channel selectivity (typical)	65 dB [Narrow], 75 dB [Middle]/[Wide]		
	Spurious response	75 dB		
	Intermodulation (typical)	75 dB	67 dB	
	Hum and noise (typical)	(without CCITT filter) (with CCITT filter)	40 dB [Narrow], 45 dB [Wide] —	— 50 dB [Narrow], 53 dB [Middle], 55 dB [Wide]
	Audio output power	4 W typical at 10% distortion with a 4 Ω load		
External SP connector	2-conductor 3.5 (d) mm (1/8")/4 Ω			

All stated specifications are subject to change without notice or obligation.

SECTION 2 INSIDE VIEW

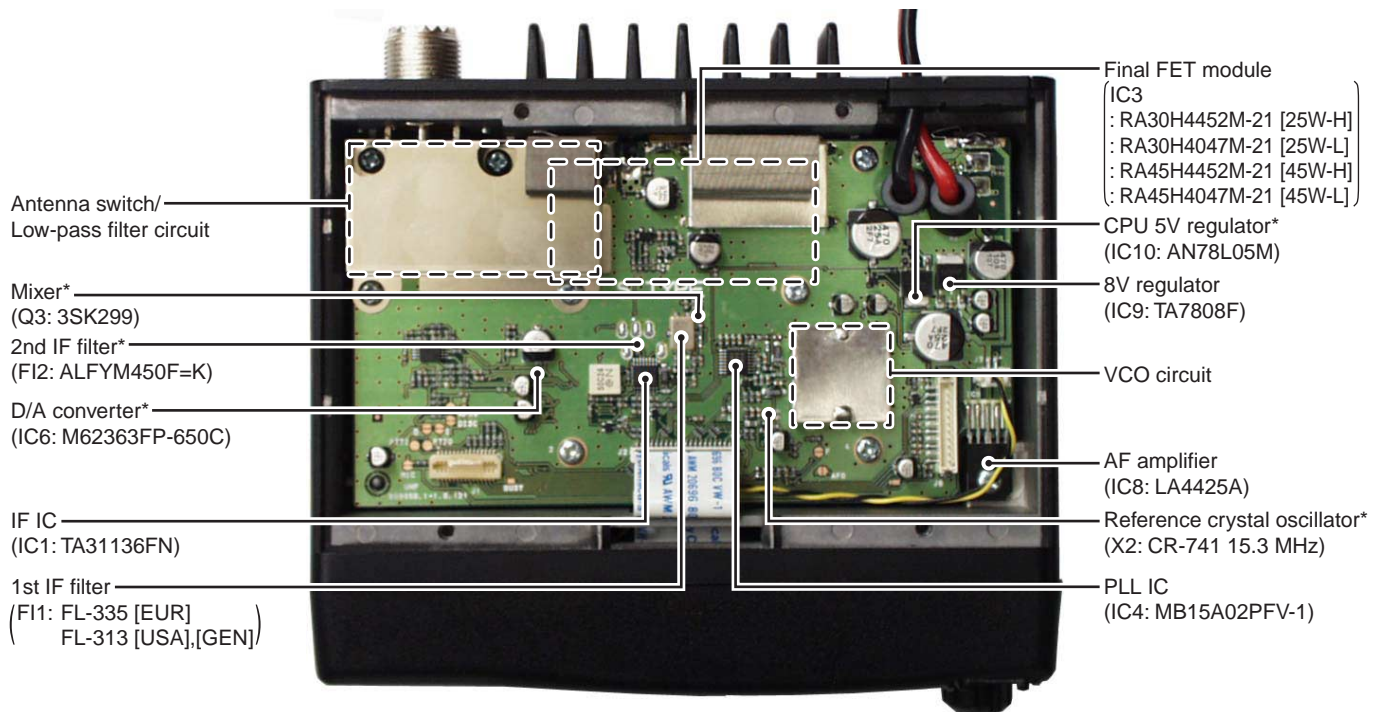

* Located under side of the point.

SECTION 3 DISASSEMBLY INSTRUCTIONS

• Opening case and removing the front unit

- ① Unscrew 4 screws (A), and remove the bottom cover.
- ② Disconnect the flat cable (B) from J2.
- ③ Disconnect the cable (C) from J7.
- ④ Unscrew 2 screws (D), and remove the front unit in the direction of the arrow.

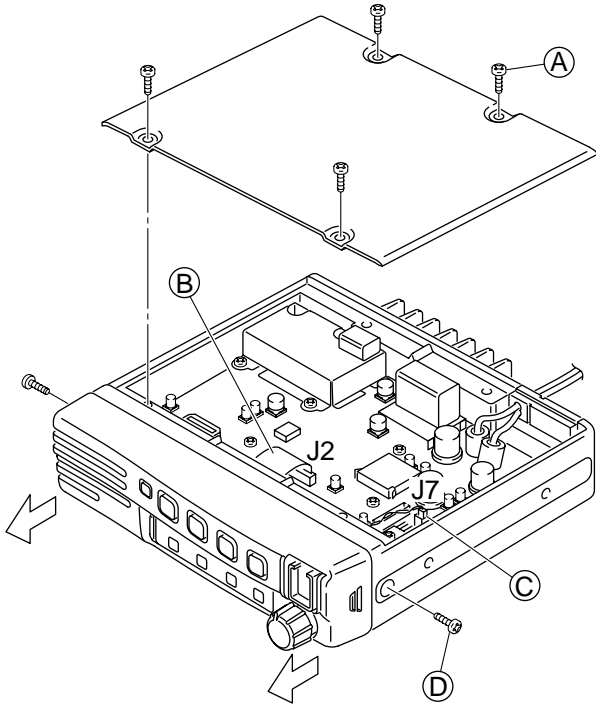

• Removing the main unit

- ① Unsolder 4 points (E), and remove the plate (F).
- ② Unsolder the point (G).

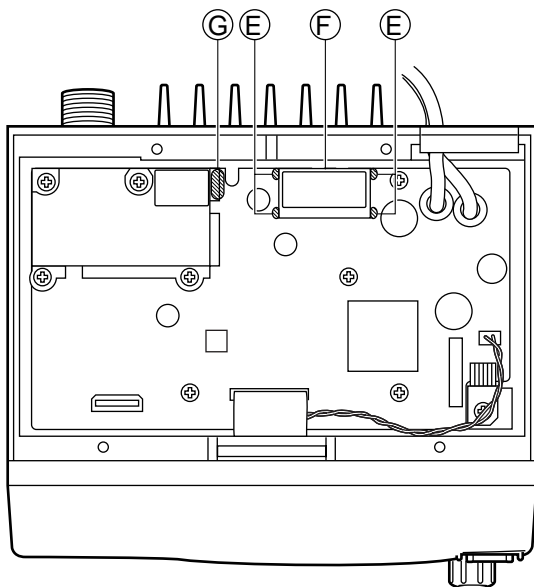

- ③ Unscrew 8 screws (H).
- ④ Remove the filter case (I).
- ⑤ Unscrew the screw (J).
- ⑥ Unsolder 3 points (K) from the antenna connector.
- ⑦ Unsolder 4 points (L) from IC3.

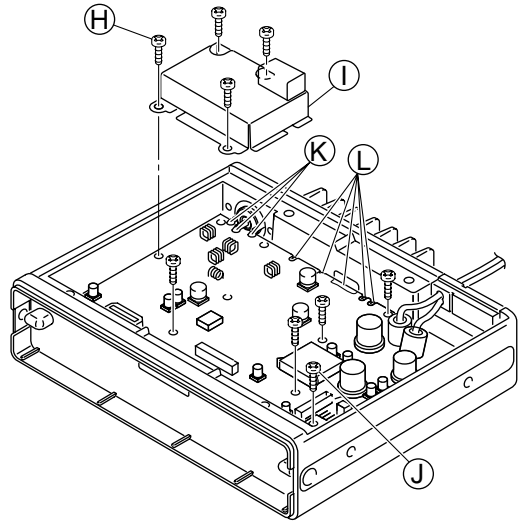

- ⑧ Lift up the front portion of the main unit and remove it.

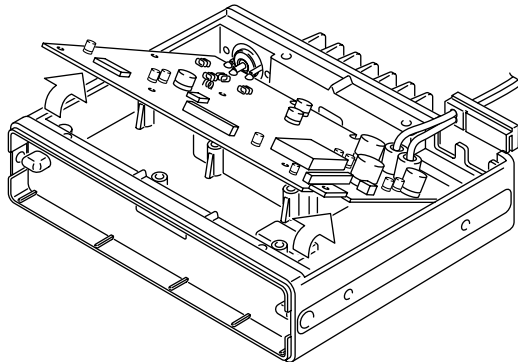

• Installation location

- | | |
|---------|--|
| UT-108 | DTMF decoder unit |
| UT-109 | Voice scrambler unit |
| UT-110 | |
| OPC-617 | ACC cable (for external terminal connection) |

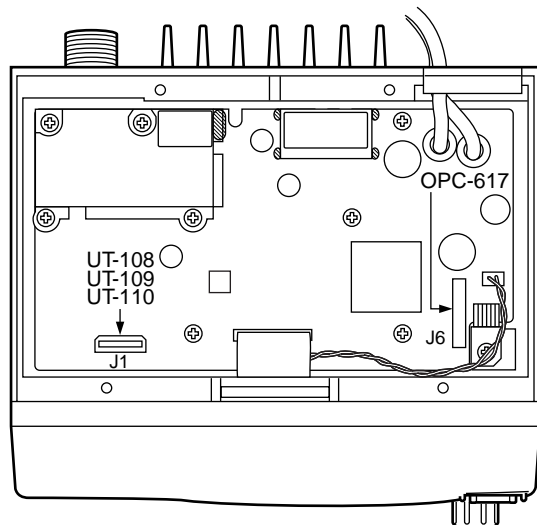

SECTION 4 CIRCUIT DESCRIPTION

4-1 RECEIVER CIRCUITS

4-1-1 ANTENNA SWITCHING CIRCUIT (MAIN UNIT)

The antenna switching circuit functions as a low-pass filter while receiving and as resonator circuit while transmitting. This circuit does not allow transmit signals to enter the receiver circuits.

Received signals enter the antenna connector and pass through the low-pass filter (L1–L3, C1, C2, C6–C8, C16). The filtered signals are then applied to the RF circuit passed through the $\lambda/4$ type antenna switching circuit (D5, D6).

4-1-2 RF CIRCUIT (MAIN UNIT)

The RF circuit amplifies signals within the range of frequency coverage and filters out-of-band signals.

The signals from the antenna switching circuit pass through the two-stage tunable bandpass filters (D8, D4). The filtered signals are amplified at the RF amplifier (Q2) and then enter other two-stage bandpass filters (D9, D10) to suppress unwanted signals. The filtered signals are applied to the 1st mixer circuit (Q3).

The tunable bandpass filters (D4, D8–D10) employ varactor diodes to tune the center frequency of the RF passband for wide bandwidth receiving and good image rejection. These diodes are controlled by the CPU (FRONT unit; IC1) via the D/A converter (IC6).

The gate control circuit reduces RF amplifier gain and attenuates RF signal to keep the audio output at a constant level.

The receiver gain is determined by the voltage on the "RSSI" line from the FM IF IC (IC1, pin 12). The gate control circuit (Q1) supplies control voltage to the RF amplifier (Q2) and sets the receiver gain.

When receiving strong signals, the "RSSI" voltage increases and the gate control voltage decreases. As the gate control voltage is used for the bias voltage of the RF amplifier (Q2), then the RF amplifier gain is decreased.

4-1-3 1ST MIXER AND 1ST IF CIRCUITS (MAIN UNIT)

The 1st mixer circuit converts the received signals to a fixed frequency of the 1st IF signal with the PLL output frequency. By changing the PLL frequency, only the desired frequency will pass through a MCF (Monolithic Crystal Filter; F11) at the next stage of the 1st mixer.

The RF signals from the bandpass filter are applied to the 1st mixer circuit (Q3). The applied signals are mixed with the 1st LO signal coming from the RX VCO circuit (Q13) to produce a 46.35 MHz 1st IF signal. The 1st IF signal passes through a MCF (Monolithic Crystal Filter; F11) to suppress out-of-band signals. The filtered signal is amplified at the 1st IF amplifier (Q4) and applied to the 2nd IF circuit.

4-1-4 2ND IF AND DEMODULATOR CIRCUITS (MAIN UNIT)

The 2nd mixer circuit converts the 1st IF signal to a 2nd IF signal. A double-conversion superheterodyne system improves the image rejection ratio and obtains stable receiver gain.

The 1st IF signal from the 1st IF amplifier (Q4) is applied to the 2nd mixer section of the FM IF IC (IC1, pin 16) and is then mixed with the 2nd LO signal for conversion to a 450 kHz 2nd IF signal.

IC1 contains the 2nd mixer, limiter amplifier, quadrature detector, active filter and noise amplifier circuits, etc. A tripled frequency from the PLL reference oscillator is used for the 2nd LO signal (45.9 MHz).

The 2nd IF signal from the 2nd mixer (IC1, pin 3) passes through a ceramic filter (F12) to remove unwanted heterodyned frequencies. It is then amplified at the limiter amplifier section (IC1, pin 5) and applied to the quadrature detector section (IC1, pins 10, 11 and X1) to demodulate the 2nd IF signal into AF signals.

The AF signals are output from pin 9 (IC1) and are then applied to the AF amplifier circuit.

• 2nd IF and demodulator circuits

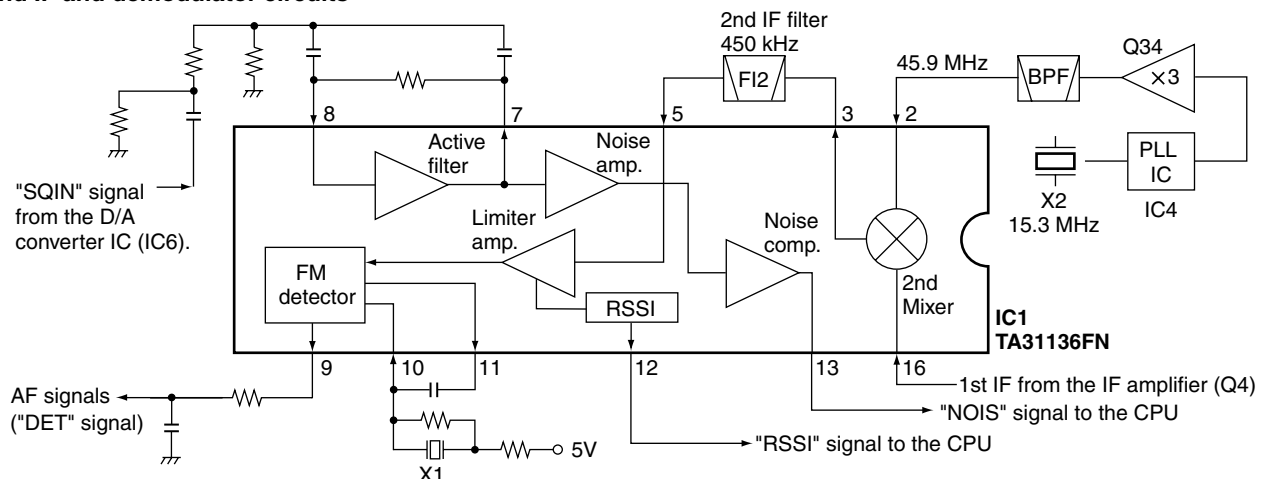

4-1-5 AF AMPLIFIER CIRCUIT (MAIN UNIT)

The AF amplifier circuit amplifies the demodulated AF signals to drive a speaker.

The AF signals from the FM IF IC (IC1, pin 9) are applied to the active filter circuit (IC16). The active filter circuit (high-pass filter) removes CTCSS or DTCS signals.

The filtered AF signals are output from pin 14 (IC16) and are applied to the de-emphasis circuit (R117, C363) with frequency characteristics of -6 dB/octave, and then passed through the analog switch (IC14, pins 1, 2) and low-pass filter (IC5, PINS 1, 2). The filtered signal is applied to the electronic volume controller (IC6, pin 9).

The output AF signals from the electronic volume controller (IC6, pin 10) are passed through the analog switch (IC14 pins 10, 11) and are applied to the AF pre-amplifier (IC15) and AF power amplifier (IC8) to drive the speaker.

4-1-6 RECEIVER MUTE CIRCUITS (MAIN AND FRONT UNITS)

• NOISE SQUELCH

The noise squelch circuit cuts out AF signals when no RF signals are received. By detecting noise components in the AF signals, the squelch circuit switches the AF mute switch.

Some noise components in the AF signals from the FM IF IC (IC1, pin 9) are passed through the level controller (IC6, pins 1, 2). The level controlled signals are applied to the active filter section in the FM IF IC (IC1, pin 8) as "SQIN" signal. Noise components about 10 kHz are amplified and output from pin 7.

The filtered signals are converted to the pulse-type signals at the noise detector section and output from pin 13 (NOIS).

The "NOIS" signal from the FM IF IC is applied to the CPU (FRONT unit; IC1, pin 53). The CPU then analyzes the noise condition and controls the AF mute signal via "AFON" line (FRONT unit; IC1, pin 43) to the AF regulator (Q35, Q36, D29, D31).

• CTCSS AND DTCS

The tone squelch circuit detects AF signals and opens the squelch only when receiving a signal containing a matching subaudible tone (CTCSS or DTCS). When tone squelch is in use, and a signal with a mismatched or no subaudible tone is received, the tone squelch circuit mutes the AF signals even when noise squelch is open.

A portion of the AF signals from the FM IF IC (IC1, pin 9) passes through the low-pass filter (IC16) to remove AF (voice) signals and is applied to the CTCSS or DTCS decoder inside the CPU (FRONT unit; IC1, pin 50) via the "CDEC" line to control the AF mute switch.

4-2 TRANSMITTER CIRCUITS

4-2-1 MICROPHONE AMPLIFIER CIRCUIT (MAIN AND FRONT UNITS)

The microphone amplifier circuit amplifies audio signals within $+6$ dB/octave pre-emphasis characteristics from the microphone to a level needed for the modulation circuit.

The AF signals (MIC) from the MIC jack (FRONT unit; J1) are amplified at the AF amplifier (FRONT unit; IC5) and applied to the MAIN unit via J2 (pin 13). The AF signal are applied to the limiter amplifier (IC5, pin 5).

The entered signals are pre-emphasized with $+6$ dB/octave at a limiter amplifier, then passed through the analog switch (IC14, pins 4, 3) and splatter filter (IC5, pins 2, 1). The output signals from the splatter filter are applied to the level controller (IC6, pins 9, 10).

The deviation level controlled signals are then applied to the modulation circuit (D18) as the "MOD" signal after being passed through the analog switch (IC14, pins 9, 8).

4-2-2 MODULATION CIRCUIT (MAIN UNIT)

The modulation circuit modulates the VCO oscillating signal (RF signal) using the microphone audio signals.

The AF signals from the analog switch (IC14, pin 8) change the reactance of varactor diode (D18) to modulate the oscillated signal at the TX VCO circuit (Q14, D17). The modulated VCO signal is amplified at the buffer amplifiers (Q11, Q10) and is then applied to the drive amplifier circuit via the T/R switch (D14).

The CTCSS/DTCS signals from the CPU (FRONT unit; IC1, pins 13, 14, 19, 20) are passed through the low-pass filter (FRONT unit; IC5), mixer and splatter filter (IC5), and are then applied to the VCO circuit.

4-2-3 DRIVE AMPLIFIER CIRCUIT (MAIN UNIT)

The drive amplifier circuit amplifies the VCO oscillating signal to the level needed at the power amplifier.

The RF signal from the buffer amplifier (Q10) passes through the T/R switch (D14) and is amplified at the drive amplifier circuit (Q8). The amplified signal is applied to the power amplifier circuit.

4-2-4 POWER AMPLIFIER CIRCUIT (MAIN UNIT)

The power amplifier circuit amplifies the driver signal to an output power level.

The RF signal from the drive amplifier (Q8) is passed through the low-pass filter circuit (L18, C90, C89) and applied to the power module (IC3) to obtain 25 W or 45 W of RF power.

The amplified signal is passed through the antenna switching circuit (D2, D3), low-pass filter and APC detector, and is then applied to the antenna connector.

Control voltage for the power amplifier (IC3, pin 2) comes from the APC amplifier (IC2) to stabilize the output power. The transmit mute switch (D28) controls the APC amplifier when transmit mute is necessary.

4-2-5 APC CIRCUIT (MAIN UNIT)

The APC circuit protects the power amplifier from a mismatched output load and stabilizes the output power.

The APC detector circuit detects forward signals and reflection signals at D1 and D11 respectively. The combined voltage is at minimum level when the antenna impedance is matched at 50 Ω, and is increased when it is mismatched.

The detected voltage is applied to the APC amplifier (IC2, pin 3), and the power setting "T2" signal from the D/A converter (IC6, pin 22), controlled by the CPU (FRONT unit; IC1), is applied to the other input for reference. When antenna impedance is mismatched, the detected voltage exceeds the power setting voltage. Then the output voltage of the APC amplifier (IC2, pin 4) controls the input current of the drive amplifier (Q8) and power module (IC3) to reduce the output power.

4-3 PLL CIRCUITS

4-3-1 PLL CIRCUIT (MAIN UNIT)

A PLL circuit provides stable oscillation of the transmit frequency and receive 1st LO frequency. The PLL output compares the phase of the divided VCO frequency to the reference frequency. The PLL output frequency is controlled by the divided ratio (N-data) of a programmable divider.

The PLL circuit contains the TX/RX VCO circuit (Q14, Q13). The oscillated signal is amplified at the buffer amplifiers (Q11, Q12) and then applied to the PLL IC (IC4, pin 8) via the low-pass filter (L32, C299, C300).

The PLL IC contains a prescaler, programmable counter, programmable divider and phase detector, etc. The entered signal is divided at the prescaler and programmable counter section by the N-data ratio from the CPU. The reference signal is generated at the reference oscillator (X2) and is also applied to the PLL IC. The PLL IC detects the out-of-step phase using the reference frequency, and outputs it from pin 5. The output signal is passed through the loop filter (R96/C130/C147, R95/C146), and is then applied to the VCO circuit as the lock voltage.

If the oscillated signal drifts, its phase changes from that of the reference frequency, causing a lock voltage change to compensate for the drift in the oscillated frequency.

4-3-2 VCO CIRCUIT (MAIN UNIT)

The VCO circuit contains a separate RX VCO (Q13, D16) and TX VCO (Q14, D17). The oscillated signal is amplified at the buffer amplifiers (Q11, Q10) and is then applied to the T/R switch circuit (D14, D15). Then the receive 1st LO (RX) signal is applied to the 1st mixer (Q3) and the transmit (TX) signal to the drive amplifier circuit (Q8).

A portion of the signal from the buffer amplifier (Q11) is fed back to the PLL IC (IC4, pin 8) via the buffer amplifier (Q12) and low-pass filter (L32, C299, C300) as the comparison signal.

• PLL circuit

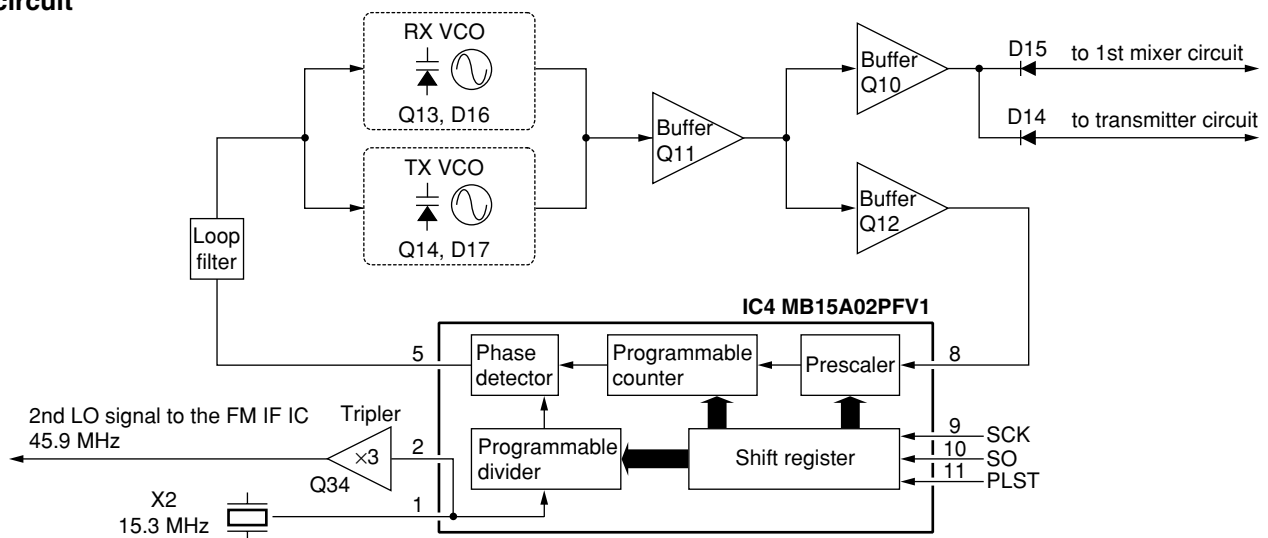

4-4 POWER SUPPLY CIRCUITS

4-4-1 VOLTAGE LINES (MAIN UNIT)

Line	Description
HV	The voltage from a DC power supply.
VCC	The same voltage as the HV line which is controlled by the power switching circuit (Q23, Q24). When the [POWER] switch is pushed, the CPU outputs the "PWON" control signal to the power switching circuit to turn the circuit ON.
CPU5V	Common 5 V for the CPU converted from the HV line by the CPU5V regulator circuit (IC10). The circuit outputs the voltage regardless of the power ON/OFF condition.
8V	Common 8 V converted from the VCC line by the 8V regulator circuit (IC9).
5V	Common 5 V converted from the VCC line by the 5V regulator circuit (Q27, Q28).
R8V	Receive 8 V controlled by the R8 regulator circuit (Q26, Q30) using the "RXC" signal from the CPU (FRONT unit; IC1, pin 18).
T8V	Transmit 8 V controlled by the T8 regulator circuit (Q25, Q29, D23) using the "TMUT" signal from the CPU (FRONT unit; IC1, pin 40).

4-5 PORT ALLOCATIONS

4-5-1 LED DRIVER (FRONT UNIT; IC4)

Pin number	Port name	Description
5-11	CH1-CH4 LP0-LP2	Output LEDs control signals. Low : While LEDs are ON.
14	RLED	Outputs BUSY LED control signal.
15	TLED	Outputs TX LED control signal.
16	LIGT1	Outputs LED bright control signal.
17	LIGT2	Outputs backlight control signal.
18	HORN	Outputs external device control signal. High : When matched 5/2 tone signals are received.

4-5-2 OUTPUT EXPANDER (MAIN unit; IC6)

Pin number	Port name	Description
2	VOUT1	Outputs squelch control signal.
3	VOUT2	Outputs deviation (Tone) control signal.
10	VOUT3	Outputs deviation control signal.
11	VOUT4	Outputs DTCS control signal.
14	VOUT5	Outputs RX BPF control signal.
15	VOUT6	Outputs AGC control signal.
22	VOUT7	Outputs TX RF power control signal.
23	VOUT8	Outputs PLL reference control signal.

4-5-3 CPU (FRONT UNIT; IC1)

Pin number	Port name	Description
1	TEMP	Input port for the internal temperature.
2	BATV	Input port for low voltage detection from the connected power supply.
7	RES	Input port for the reset signal.
13, 14	SENC0, SENC1	Output ports for 5/2 tone and DTMF signals.
15	CSFT	Outputs the CPU clock shift signal.
16	DUSE	Outputs the cut-off frequency control signal to the low-pass filter (MAIN; unit IC5) for CTCSS/DTCS switching.
17	UNLK	Input port for the PLL unlock signal from the PLL IC (MAIN unit; IC4).
18	RXC	Outputs the R8V regulator circuit (MAIN unit; Q26, Q30) control signal.
19, 20	SENC0, SENC1	Output ports for 5/2 tone and DTMF signals.
21, 22	P0, P1	Input ports for key matrix.
23-25	CENO0- CENO2	Output ports for CTCSS/DTCS signals.
26, 27	P2, P3	Input ports for key matrix.
28	SCK	Outputs clock signal to the PLL IC (MAIN unit; IC4), D/A converter (MAIN unit IC6), LED driver (FRONT unit; IC4) and optional board (connect to MAIN unit; J1).
29	SO	Outputs data signal to the PLL IC (MAIN unit; IC4), D/A converter (MAIN unit; IC6), LED driver (FRONT unit; IC4) and optional board (connect to MAIN unit; J1).
30	BEEP	Output port for beep sound signal.
31	ESDA	I/O port for the data signal for the EEPROM (FRONT unit; IC3)
32	ESCL	Outputs clock signal for the EEPROM (FRONT unit; IC3).
33	MMUT	Input port for the MIC mute signal from the optional board via MAIN unit, J1.
34	RMUT	Input port for the AF mute signal from the optional board via MAIN unit, J1.
36	PLST	Outputs strobe signal for the PLL IC (MAIN unit; IC4).
37	DAST	Outputs strobe signal for the D/A converter IC (MAIN unit; IC6).
38	EXST	Outputs strobe signal for LED driver IC (FRONT unit; IC4).
39	EXOE	Outputs control signal for the LED driver IC (FRONT unit; IC4).
40	TMUT	Outputs the T8V regulator circuit (MAIN unit; Q25, Q29, D23) control signal.

CPU-Continued

Pin number	Port name	Description
41	PWON	Outputs control signal for the power switching circuit (MAIN unit; Q23, Q24).
42	NWC	Outputs IF bandwidth control signal. Low : While IF bandwidth is narrow.
43	AFON	Outputs control signal for the AF mute circuit (MAIN unit; Q35, Q36, D29). High : While AF amplifier (MAIN unit; IC8) is activated.
44–46	OPT3– OPT1	I/O ports for the optional board control signals.
47	BUSY	Outputs BUSY detection signal for the optional board via MAIN unit, J1.
48	SI	Input port for the clock signal from the optional board via MAIN unit, J1.
49	CLI	Input port for the cloning signal.
50	CLO	Output port for the cloning signal.
51	POSW	Input for the POWER switch.
52	IGSW	Input port for the remote control signal from external connector (Main unit; J6).
53	NOIS	Input port for the “NOIS” signal which is used noise squelch operation from the FM IC (MAIN unit; IC1)
54	CIRQ	Input port for the interruption signal from the optional board via MAIN unit, J1.
55	CCS	Outputs the chip select signal for the optional board via MAIN unit, J1.
56	PTT	Input port for the PTT switch from microphone.
57	EPTT	Input port for the PTT switch from the external connector (MAIN unit; J6). Low : External PTT switch is ON.
58	HANG	Input port for the microphone hanger detection signal. Low :The microphone on hook.
59	AFVI	Input port for the AF volume control (FRONT unit; R14). High : [VOL] is maximum clockwise.
60	CDEC	Input port for CTCSS/DTCS decoding signals.
61	SDEC	Input port for the single tone decoding signals.
62	OPV1V2	Input port for the optional board detection signal.
63	RSSI	Input port for the decoding signal of the received signal strength.
64	LVIN	Input port for the PLL lock voltage.

SECTION 5 ADJUSTMENT PROCEDURES

5-1 PREPARATION

When you adjust the contents on pages 5-5 and 5-6, SOFTWARE ADJUSTMENT, the optional CS-F100S ADJ ADJUSTMENT SOFTWARE (Rev. 1.0 or later), *OPC-1122 JIG CABLE (modified OPC-1122 CLONING CABLE; see illustration below) are required.

SYSTEM REQUIREMENTS

- IBM PC compatible computer with an RS -232C serial port (38400 bps or faster).
- Microsoft Windows 95/98 or Windows ME
- Intel Pentium 100 MHz processor or faster
- At least 16 MB RAM and 10 MB of hard disk space
- 640×480 pixel display (800×600 pixel display recommended)

IBM is a registered trademark of International Bussiness Machines Corporation in the U.S.A. and other countries. Microsoft and Windows are registered trademarks of Microsoft Corporation in the U.S.A. and other countries. Screen shots produced with permission from Microsoft Corporation. All other products or brands are registered trademarks or trademarks of their respective holders.

ADJUSTMENT SOFTWARE INSTALLATION

- ① Boot up Windows.
 - Quit all applications when Windows is running.
- ② Insert the 'CS-F100S' into the appropriate CD drive.
- ③ Select 'Run' from the [Start] menu.
- ④ Type the setup program name using the full path name, then push [Enter] key.
(ex. D:\CSF100SADJ\Setup.exe)
- ⑤ Follow the prompts.
- ⑥ Program group 'CS-F100S ADJ' appears in the 'Programs' folder of the [Start] menu.

STARTING SOFTWARE ADJUSTMENT

- ① Connect IC-F210S and PC with *OPC-1122 JIG CABLE.
- ② Turn the transceiver power ON.
- ③ Boot up Windows, and click the program group 'CS-F100S ADJ' in the 'Programs' folder of the [Start] menu, then CS-F100S ADJ's window appears.
- ④ Click 'Connect' on the CS-F100's window, then appears IC-F210S's up-to-date condition.
- ⑤ Set or modify adjustment data as desired.

*OPC-1122 (JIG CABLE)

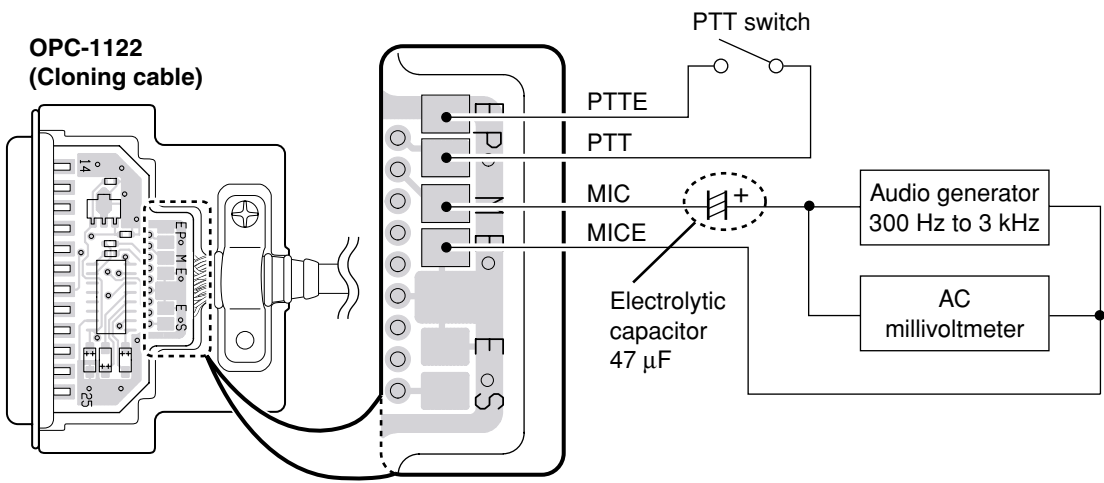
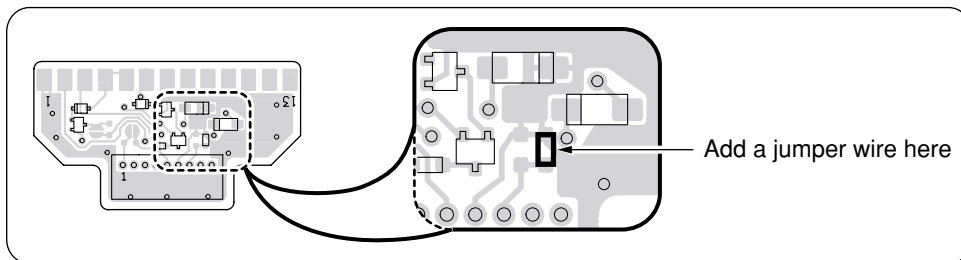

■ REQUIRED TEST EQUIPMENT

EQUIPMENT	GRADE AND RANGE	EQUIPMENT	GRADE AND RANGE
DC power supply	Output voltage : 13.2 V DC Current capacity : 15 A or more	Audio generator	Frequency range : 300–3000 Hz Measuring range : 1–500 mV
RF power meter (terminated type)	Measuring range : 1–100 W Frequency range : 300–600 MHz Impedance : 50 Ω SWR : Less than 1.2 : 1	Standard signal generator (SSG)	Frequency range : 0.1–600 MHz Output level : 0.1 μV–32 mV (–127 to –17 dBm)
Frequency counter	Frequency range : 0.1–600 MHz Frequency accuracy : ±1 ppm or better Sensitivity : 100 mV or better	Oscilloscope	Frequency range : DC–20 MHz Measuring range : 0.01–20 V
FM deviation meter	Frequency range : DC–600 MHz Measuring range : 0 to ±10 kHz	AC millivoltmeter	Measuring range : 10 mV–10 V
Digital multimeter	Input impedance : 50 kΩ/V DC or better	External speaker	Input impedance : 4 Ω Capacity : 7 W or more
		Attenuator	Power attenuation : 40 or 50 dB Capacity : 100 W or more

• Connections

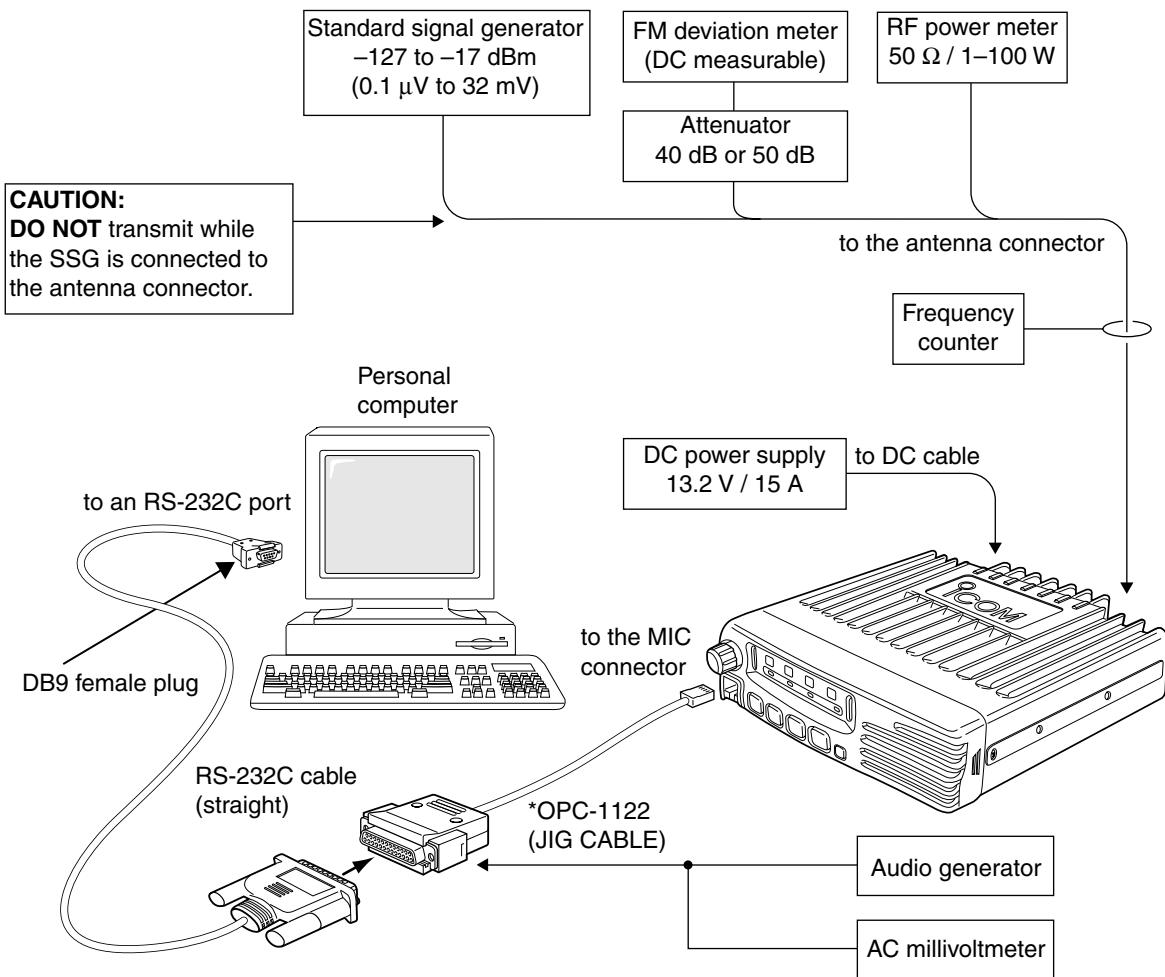

• Screen display example

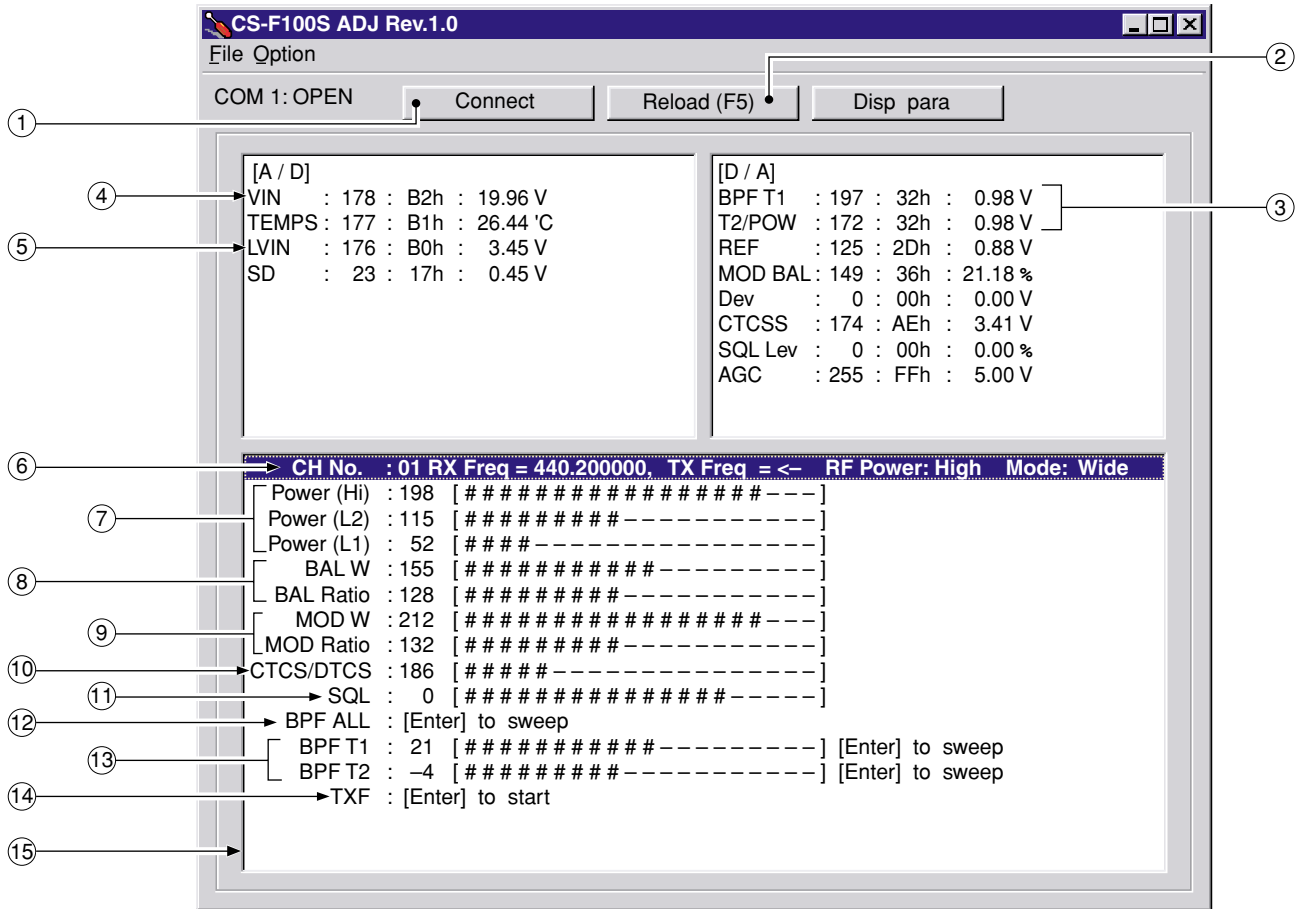

NOTE: The above values for settings are example only.
Each transceiver has its own specific values for each setting.

- | | |
|-------------------------------------|---|
| ① : Transceiver's connection state | ⑨ : FM deviation |
| ② : Reload adjustment data | ⑩ : CTCSS/DTCS deviation |
| ③ : Receive sensitivity measurement | ⑪ : Squelch level |
| ④ : Connected DC voltage | ⑫ : Receive sensitivity (automatically) |
| ⑤ : PLL lock voltage | ⑬ : Receive sensitivity (manually) |
| ⑥ : Operating channel select | ⑭ : Reference frequency |
| ⑦ : RF output power | ⑮ : Adjustment items |
| ⑧ : Modulation balance | |

5-2 PLL ADJUSTMENT

ADJUSTMENT	ADJUSTMENT CONDITIONS	MEASUREMENT		VALUE	ADJUSTMENT	
		UNIT	LOCATION		UNIT	ADJUST
PLL LOCK VOLTAGE	1 • Operating freq. : 400.000 MHz [L] 440.000 MHz [H] • Receiving	MAIN	Connect a digital multi-meter or an oscilloscope to the check point, "LV".	1.0 V	MAIN	C133
	2 • Output power : Low1 • Transmitting					C134
	3 • Operating freq. : 430.000 MHz [L] 490.000 MHz [H]					Verify
	4 • Receiving • Output power : Low1 • Transmitting					Verify

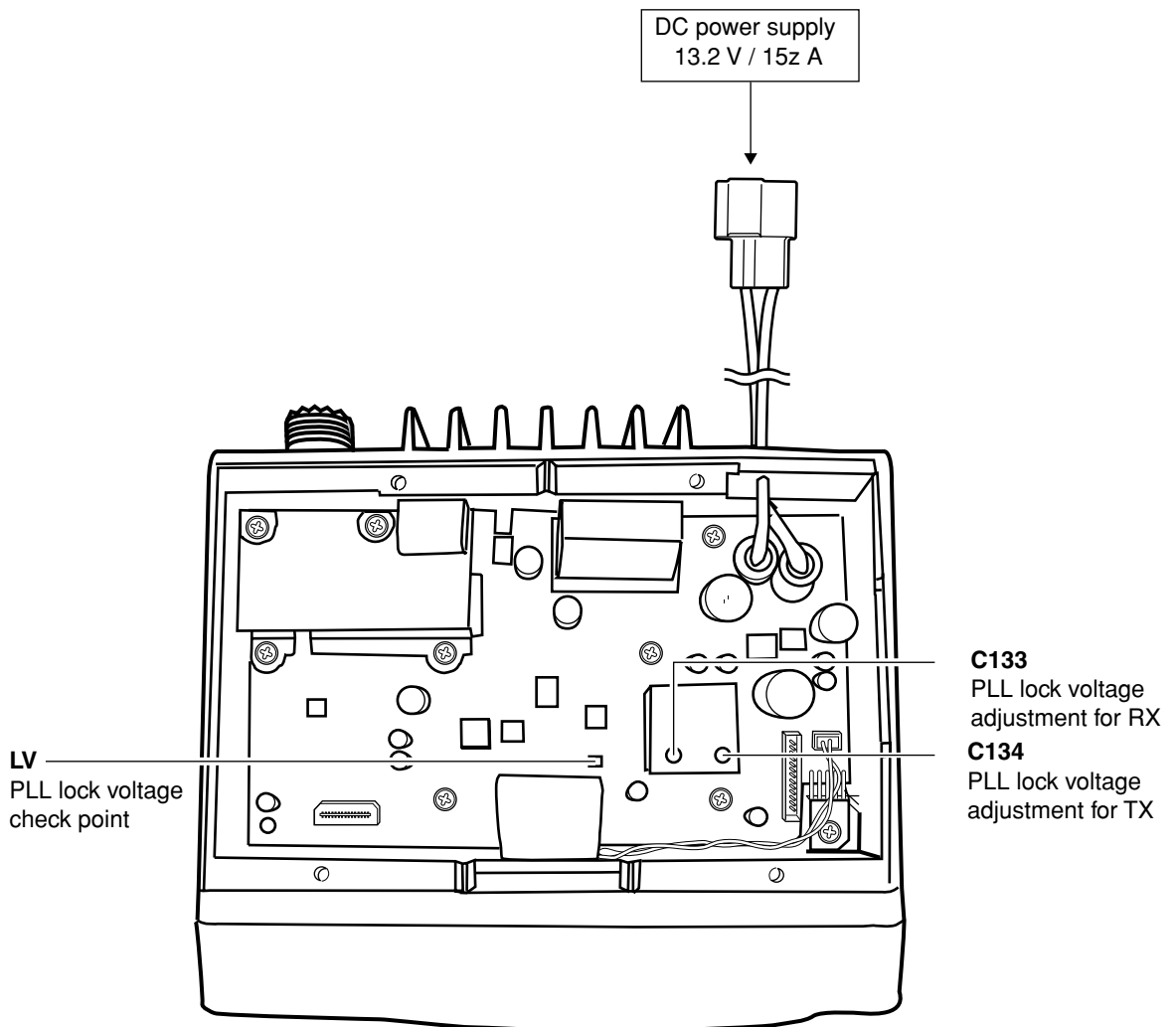

5-3 SOFTWARE ADJUSTMENT

Select an operation using [↑] / [↓] keys, then set specified value using [←] / [→] keys on the connected computer keyboard.

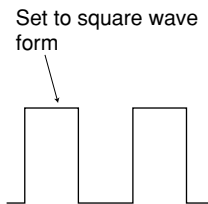
ADJUSTMENT	ADJUSTMENT CONDITION	MEASUREMENT		VALUE
		UNIT	LOCATION	
REFERENCE FREQUENCY [TXF]	1 <ul style="list-style-type: none"> Operating freq. : 490.000 MHz 430.000 MHz Output power : Low1 Connect the RF power meter or 50 Ω dummy load to the antenna connector. Transmitting 	Rear panel	Loosely couple a frequency counter to the antenna connector.	490.0000 MHz [H] 430.0000 MHz [L]
OUTPUT POWER [Power (Hi)]	1 <ul style="list-style-type: none"> Operating freq. : 465.000 MHz [H] 415.000 MHz [L] Output power : High Transmitting 	Rear panel	Connect an RF power meter to the antenna connector.	25.0 W [25 W] 45.0 W [45 W]
[Power (L2)]	2 <ul style="list-style-type: none"> Output power : Low2 Transmitting 			10.0 W [25 W] 25.0 W [45 W]
[Power (L1)]	3 <ul style="list-style-type: none"> Output power : Low1 Transmitting 			2.5 W [25 W] 5.0 W [5 W]
FM DEVIATION [MOD W]	1 <ul style="list-style-type: none"> Operating freq. : 415.000 MHz [L] 465.000 MHz [H] Output power : Low1 IF bandwidth : Wide Connect an audio generator to the [MIC] jack through the JIG cable and set as: 1.0 kHz/40 mVrms Set an FM deviation meter as: HPF : OFF LPF : 20 kHz De-emphasis: OFF Detector : (P-P)/2 Transmitting 	Rear panel	Connect an FM deviation meter to the antenna connector through the attenuator.	±4.1 kHz [N/W] ±3.3 kHz [N/M]
[MOD Ratio]	2 <ul style="list-style-type: none"> IF bandwidth : Narrow Transmitting 			±2.1 kHz
MODULATION BALLANCE [BAL W]	1 <ul style="list-style-type: none"> Set to the DTCS set channel, and push [Connect] on the adjustment software. Operating freq. : 415.000 MHz [L] 465.000 MHz [H] Output power : Low1 Transmitting 	Rear panel	Connect an FM deviation meter with an oscilloscope to the antenna connector through an attenuator.	Set to square wave form 
[BAL Ratio]	2 <ul style="list-style-type: none"> IF bandwidth : Narrow Transmitting 			
CTCSS/DTCS DEVIATION [CTCS/DTCS]	1 <ul style="list-style-type: none"> Operating freq. : 415.000 MHz [L] 465.000 MHz [H] Output power : Low1 IF bandwidth : Wide CTCSS : 254.1 Hz DTCS code : 007 Set the FM deviation meter as: HPF : OFF LPF : 20 kHz De-emphasis: OFF Detector : (P-P)/2 No audio applied to the [MIC] connector. Transmitting 	Rear panel	Connect an FM deviation meter to the antenna connector through the attenuator.	±0.7 kHz

SOFTWARE ADJUSTMENT – continued

Select an operation using [↑] / [↓] keys, then set specified value using [←] / [→] keys on the connected computer keyboard.

ADJUSTMENT	ADJUSTMENT CONDITION	MEASUREMENT		VALUE	
		UNIT	LOCATION		
RX SENSITIVITY [BPF T1], [BPF T2]	1	<ul style="list-style-type: none"> Operating freq. : 400.000 MHz [L] 440.000 MHz [H] IF bandwidth : Wide Connect a standard signal generator to the antenna connector and set as: Frequency : 440.000 MHz [L] 440.000 MHz [H] Level : 10 μV* (-87 dBm) Modulation : 1 kHz Deviation : ±3.5 kHz [N/W] ±2.8 kHz [N/M] Receiving 	MAIN	Connect a SINAD meter with a 4 Ω load to the external [SP] jack.	Minimum distortion level
	<p>CONVENIENT: The BPF T1–BPF T2 can be adjusted automatically.</p> <p>①-1: Set the cursor to “BPF ALL” on the adjustment program and then push [ENTER] key. ①-2: The connected PC tunes BPF T1, BPF T2 to peak levels. or ②-1: Set the cursor to BPF T1 or BPF T2 as desired. ②-2: Push [ENTER] key to start tuning. ②-3: Repeat ②-1 and ②-2 to perform additional BPF tuning.</p>				
SQUELCH LEVEL [SQL]	1	<ul style="list-style-type: none"> Operating freq. : 415.000 MHz [L] 465.000 MHz [H] IF bandwidth : Narrow Connect an SSG to the antenna connector and set as: Frequency : 415.000 MHz [L] 465.000 MHz [H] Level : 0.2 μV* (-121 dBm) Modulation : 1 kHz Deviation : ±1.75 kHz Receiving 	Rear panel	Connect a SINAD meter with a 4 Ω load to the external [SP] jack.	Set “SQL level” to close squelch. Then set “SQL level” at the point where the audio signals just appears.

*The output level of the standard signal generator (SSG) is indicated as the SSG's open circuit.

5-4 TRIMMER ADJUSTMENT

- Make this adjustment if necessary (For example, when beep sound is too loud or too soft).
- **BE CAREFUL!**: 5-tone calling beep sound becomes loud or soft when beep volume adjusts to loud or soft.

ADJUSTMENT	ADJUSTMENT CONDITIONS	MEASUREMENT		ADJUSTMENT	
		UNIT	LOCATION	UNIT	ADJUST
BEEP VOLUME	1 <ul style="list-style-type: none"> • Operating freq. : Any • Receiving 	FRONT	Push any button except [POWER] switch, then verify the beep volume level.	FRONT	R59

• FRONT PANEL

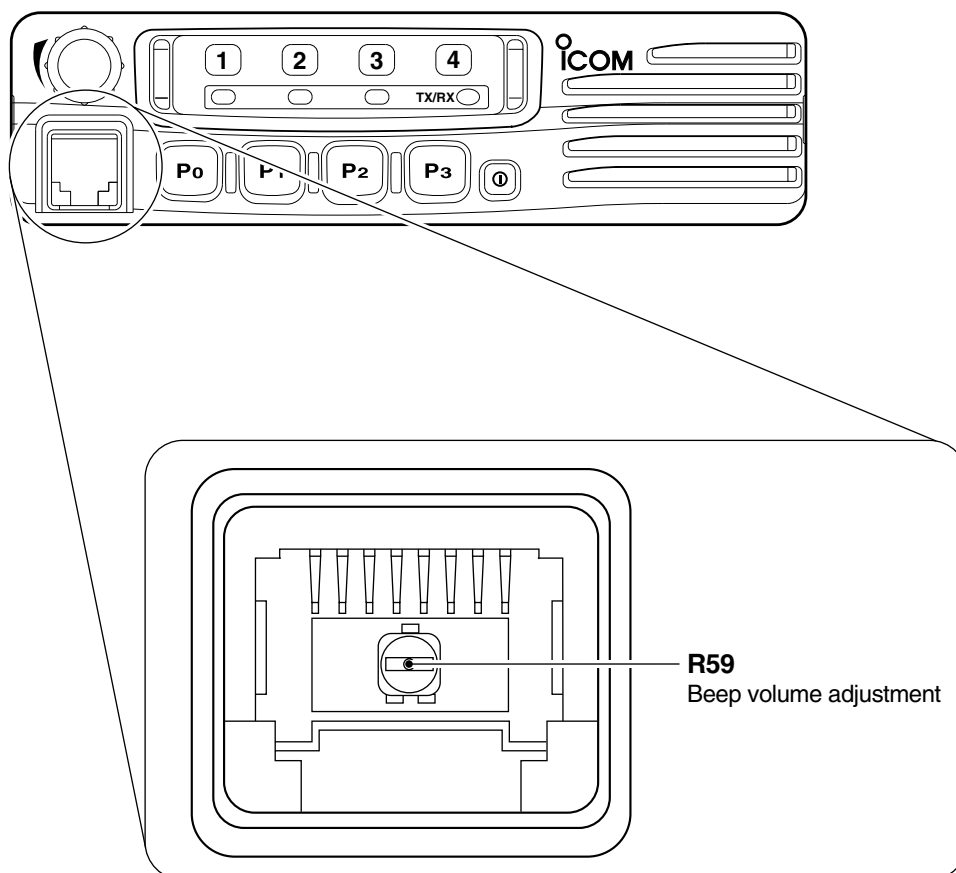

SECTION 6 PARTS LIST

[FRONT UNIT]

REF NO.	ORDER NO.	DESCRIPTION	
IC1	1140010890	S.IC	HD6433687A05FP
IC2	1110005770	S.IC	S-80942CNMC-G9C-T2
IC3	1130010390	S.IC	HN58X2416T1
IC4	1130009670	S.IC	BU2092FV-E2
IC5	1110005340	S.IC	NJM12902V-TE1
Q1	1530002060	S.TRANSISTOR	2SC4081 T106 R
Q2	1590001050	S.TRANSISTOR	DTC114TUA T106
Q3	1590000430	S.TRANSISTOR	DTC144EUA T106
D1	1790000950	S.ZENER	MA8056-M (TX)
D2	1790000950	S.ZENER	MA8056-M (TX)
D3	1790000950	S.ZENER	MA8056-M (TX)
D4	1790000620	S.DIODE	MA77 (TX)
D5	1790001250	S.DIODE	MA2S111-(TX)
X1	6050009520	S.XTAL	CR-520 (19.6608 MHz)
L1	6200003640	S.COIL	MLF1608E 100K-T
L2	6200001980	S.COIL	NL 252018T-1R0J
R1	7030008400	S.RESISTOR	ERJ2GEJ 182 X (1.8 kΩ)
R2	7030009280	S.RESISTOR	ERJ2GE
R3	7030005120	S.RESISTOR	ERJ2GEJ 102 X (1 kΩ)
R4	7030005120	S.RESISTOR	ERJ2GEJ 102 X (1 kΩ)
R5	7030005120	S.RESISTOR	ERJ2GEJ 102 X (1 kΩ)
R6	7030005010	S.RESISTOR	ERJ2GEJ 681 X (680 Ω)
R7	7030005010	S.RESISTOR	ERJ2GEJ 681 X (680 Ω)
R8	7030005010	S.RESISTOR	ERJ2GEJ 681 X (680 Ω)
R9	7030005010	S.RESISTOR	ERJ2GEJ 681 X (680 Ω)
R10	7030005030	S.RESISTOR	ERJ2GEJ 152 X (1.5 kΩ)
R11	7030008370	S.RESISTOR	ERJ2GEJ 561 X (560 Ω)
R12	7030009280	S.RESISTOR	ERJ2GE
R13	7030005050	S.RESISTOR	ERJ2GEJ 103 X (10 kΩ)
R14	7210003020	VARIABLE	EVU-F2KFK1 B14 (10KB)
R15	7030005120	S.RESISTOR	ERJ2GEJ 102 X (1 kΩ)
R16	7030005120	S.RESISTOR	ERJ2GEJ 102 X (1 kΩ)
R17	7030005090	S.RESISTOR	ERJ2GEJ 104 X (100 kΩ)
R18	7030005090	S.RESISTOR	ERJ2GEJ 104 X (100 kΩ)
R19	7030005090	S.RESISTOR	ERJ2GEJ 104 X (100 kΩ)
R20	7030008300	S.RESISTOR	ERJ2GEJ 184 X (180 kΩ)
R21	7030005720	S.RESISTOR	ERJ2GEJ 563 X (56 kΩ)
R22	7030005220	S.RESISTOR	ERJ2GEJ 223 X (22 kΩ)
R23	7030005240	S.RESISTOR	ERJ2GEJ 473 X (47 kΩ)
R24	7030005240	S.RESISTOR	ERJ2GEJ 473 X (47 kΩ)
R25	7030005220	S.RESISTOR	ERJ2GEJ 223 X (22 kΩ)
R26	7030005240	S.RESISTOR	ERJ2GEJ 473 X (47 kΩ)
R27	7030005240	S.RESISTOR	ERJ2GEJ 473 X (47 kΩ)
R28	7030005040	S.RESISTOR	ERJ2GEJ 472 X (4.7 kΩ)
R29	7030008290	S.RESISTOR	ERJ2GEJ 183 X (18 kΩ)
R30	7030005110	S.RESISTOR	ERJ2GEJ 224 X (220 kΩ)
R31	7030005090	S.RESISTOR	ERJ2GEJ 104 X (100 kΩ)
R32	7030005240	S.RESISTOR	ERJ2GEJ 473 X (47 kΩ)
R33	7030005220	S.RESISTOR	ERJ2GEJ 223 X (22 kΩ)
R34	7030005220	S.RESISTOR	ERJ2GEJ 223 X (22 kΩ)
R35	7030005070	S.RESISTOR	ERJ2GEJ 683 X (68 kΩ)
R36	7030005070	S.RESISTOR	ERJ2GEJ 683 X (68 kΩ)
R37	7030005070	S.RESISTOR	ERJ2GEJ 683 X (68 kΩ)
R38	7030005070	S.RESISTOR	ERJ2GEJ 683 X (68 kΩ)
R39	7030005070	S.RESISTOR	ERJ2GEJ 683 X (68 kΩ)
R40	7030005240	S.RESISTOR	ERJ2GEJ 473 X (47 kΩ)
R41	7030005050	S.RESISTOR	ERJ2GEJ 103 X (10 kΩ)
R42	7030007350	S.RESISTOR	ERJ2GEJ 393 X (39 kΩ)
R43	7030005060	S.RESISTOR	ERJ2GEJ 333 X (33 kΩ)
R44	7030005100	S.RESISTOR	ERJ2GEJ 154 X (150 kΩ)
R45	7030005530	S.RESISTOR	ERJ2GEJ 100 X (10 Ω)
R46	7030005160	S.RESISTOR	ERJ2GEJ 105 X (1 MΩ)
R47	7030008010	S.RESISTOR	ERJ2GEJ 123 X (12 kΩ)
R48	7030008010	S.RESISTOR	ERJ2GEJ 123 X (12 kΩ)

- Ⓐ: IC-F210S (25 W) Ⓑ: IC-F211S/F221S (45 W)
 Ⓒ: IC-F210S for [EUR] Ⓓ: IC-F221S for [USA]
 Ⓔ: IC-F210S/F211S for [GEN] Ⓔ: IC-F210S for high band
 Ⓕ: IC-F211S/221S for high band Ⓕ: IC-F210S for low band

[FRONT UNIT]

REF NO.	ORDER NO.	DESCRIPTION	
R49	7030008010	S.RESISTOR	ERJ2GEJ 123 X (12 kΩ)
R50	7410001130	S.ARRAY	EXB28V102JX
R51	7030005090	S.RESISTOR	ERJ2GEJ 104 X (100 kΩ)
R52	7030005120	S.RESISTOR	ERJ2GEJ 102 X (1 kΩ)
R53	7410001130	S.ARRAY	EXB28V102JX
R54	7410001130	S.ARRAY	EXB28V102JX
R55	7410000770	S.ARRAY	EXB-V4V 102JV (1 kΩ)
R56	7410001130	S.ARRAY	EXB28V102JX
R57	7030005160	S.RESISTOR	ERJ2GEJ 105 X (1 MΩ)
R58	7030005050	S.RESISTOR	ERJ2GEJ 103 X (10 kΩ)
R59	7310002740	S.TRIMMER	RV-150 (RH03A3A14X0FC) 103
R60	7030005090	S.RESISTOR	ERJ2GEJ 104 X (100 kΩ)
R61	7030005090	S.RESISTOR	ERJ2GEJ 104 X (100 kΩ)
R62	7030005090	S.RESISTOR	ERJ2GEJ 104 X (100 kΩ)
R63	7030005090	S.RESISTOR	ERJ2GEJ 104 X (100 kΩ)
R64	7030005090	S.RESISTOR	ERJ2GEJ 104 X (100 kΩ)
R65	7030005090	S.RESISTOR	ERJ2GEJ 104 X (100 kΩ)
R66	7030005090	S.RESISTOR	ERJ2GEJ 104 X (100 kΩ)
R67	7030005050	S.RESISTOR	ERJ2GEJ 103 X (10 kΩ)
R68	7030005050	S.RESISTOR	ERJ2GEJ 103 X (10 kΩ)
R69	7030005090	S.RESISTOR	ERJ2GEJ 104 X (100 kΩ)
R70	7030005030	S.RESISTOR	ERJ2GEJ 152 X (1.5 kΩ)
R71	7030005120	S.RESISTOR	ERJ2GEJ 102 X (1 kΩ)
R72	7030005030	S.RESISTOR	ERJ2GEJ 152 X (1.5 kΩ)
R73	7030006610	S.RESISTOR	ERJ2GEJ 394 X (390 kΩ)
C1	4030016930	S.CERAMIC	ECJ0EB1A104K
C2	4030017420	S.CERAMIC	ECJ0EC1H470J
C3	4030017420	S.CERAMIC	ECJ0EC1H470J
C4	4030017420	S.CERAMIC	ECJ0EC1H470J
C5	4030017420	S.CERAMIC	ECJ0EC1H470J
C6	4030017420	S.CERAMIC	ECJ0EC1H470J
C7	4030017420	S.CERAMIC	ECJ0EC1H470J
C8	4030017460	S.CERAMIC	ECJ0EB1E102K
C9	4030017460	S.CERAMIC	ECJ0EB1E102K
C10	4030017460	S.CERAMIC	ECJ0EB1E102K
C11	4030017420	S.CERAMIC	ECJ0EC1H470J
C12	4030017460	S.CERAMIC	ECJ0EB1E102K
C14	4030017460	S.CERAMIC	ECJ0EB1E102K
C15	4030016780	S.CERAMIC	ECJ0EB1C153K
C16	4030016930	S.CERAMIC	ECJ0EB1A104K
C17	4030017740	S.CERAMIC	ECJ0EB1E821K
C19	4030016930	S.CERAMIC	ECJ0EB1A104K
C20	4030018110	S.CERAMIC	ECJ0EB1H272K
C21	4030018240	S.CERAMIC	ECJ0EB1E562K
C22	4030017710	S.CERAMIC	ECJ0EC1H181J
C23	4030018090	S.CERAMIC	ECJ0EB1C822K
C24	4030017510	S.CERAMIC	ECJ0EC1H680J
C25	4030016790	S.CERAMIC	ECJ0EB1C103K
C26	4030016930	S.CERAMIC	ECJ0EB1A104K
C27	4030017450	S.CERAMIC	ECJ0EB1E271K
C28	4030016930	S.CERAMIC	ECJ0EB1A104K
C29	4550006050	S.TANTALUM	TEMSVA 0J 106M8L
C30	4030017030	S.CERAMIC	ECJ0EB1A273K
C31	4030017400	S.CERAMIC	ECJ0EC1H220J
C32	4030017640	S.CERAMIC	ECJ0EC1H150J
C33	4030017510	S.CERAMIC	ECJ0EC1H680J
C34	4030017730	S.CERAMIC	ECJ0EB1E471K
C35	4030016930	S.CERAMIC	ECJ0EB1A104K
C36	4030016930	S.CERAMIC	ECJ0EB1A104K
C50	4030017420	S.CERAMIC	ECJ0EC1H470J
C54	4030017420	S.CERAMIC	ECJ0EC1H470J
C74	4030017420	S.CERAMIC	ECJ0EC1H470J
C75	4030016930	S.CERAMIC	ECJ0EB1A104K
C76	4030016930	S.CERAMIC	ECJ0EB1A104K
C77	4030016950	S.CERAMIC	ECJ0EB1A473K
C78	4030017460	S.CERAMIC	ECJ0EB1E102K
C85	4030017460	S.CERAMIC	ECJ0EB1E102K
C86	4030017460	S.CERAMIC	ECJ0EB1E102K
C87	4030017460	S.CERAMIC	ECJ0EB1E102K
J1	6450002210	CONNECTOR	3017-8821

- ①: IC-F221S for low band
 ②: Narrow/wide version
 ④: Narrow/middle version
 S.=Surface mount

[MAIN UNIT]

REF NO.	ORDER NO.	DESCRIPTION	
L32	6200005690	S.COIL	ELJRE 18NG-F (H, I)
L33	6200002850	S.COIL	NL 252018T-R82J
L35	6200002840	S.COIL	NL 252018T-R22J
L37	6200006980	S.COIL	ELJRE R10G-F
L38	6200005690	S.COIL	ELJRE 18NG-F
L41	6200005710	S.COIL	ELJRE 27NG-F
R1	7030000620	S.RESISTOR	MCR10EZHZ 100 kΩ
R2	7030000220	S.RESISTOR	MCR10EZHZ 47 Ω (470)
R3	7030000220	S.RESISTOR	MCR10EZHZ 47 Ω (470)
R4	7030003320	S.RESISTOR	ERJ3GEYJ 101 V (100 Ω) (A)
	7030003350	S.RESISTOR	ERJ3GEYJ 181 V (180 Ω) (B)
R5	7030003560	S.RESISTOR	ERJ3GEYJ 103 V (10 kΩ)
R6	7030003560	S.RESISTOR	ERJ3GEYJ 103 V (10 kΩ) (A)
	7030003630	S.RESISTOR	ERJ3GEYJ 393 V (39 kΩ) (B)
R7	7030003280	S.RESISTOR	ERJ3GEYJ 470 V (47 Ω) (B)
	7030003320	S.RESISTOR	ERJ3GEYJ 101 V (100 Ω) (A)
R8	7030006070	S.RESISTOR	ERJ12YJ101U (100 Ω)
R10	7030003470	S.RESISTOR	ERJ3GEYJ 182 V (1.8 kΩ)
R11	7030003720	S.RESISTOR	ERJ3GEYJ 224 V (220 kΩ)
R12	7030005530	S.RESISTOR	ERJ2GEJ 100 X (10 Ω)
R13	7030003720	S.RESISTOR	ERJ3GEYJ 224 V (220 kΩ)
R14	7030003560	S.RESISTOR	ERJ3GEYJ 103 V (10 kΩ)
R15	7030003640	S.RESISTOR	ERJ3GEYJ 473 V (47 kΩ)
R16	7030003380	S.RESISTOR	ERJ3GEYJ 331 V (330 Ω)
R17	7030003280	S.RESISTOR	ERJ3GEYJ 470 V (47 Ω)
R18	7030003560	S.RESISTOR	ERJ3GEYJ 103 V (10 kΩ)
R19	7030003650	S.RESISTOR	ERJ3GEYJ 563 V (56 kΩ)
R20	7030003640	S.RESISTOR	ERJ3GEYJ 473 V (47 kΩ)
R21	7030003720	S.RESISTOR	ERJ3GEYJ 224 V (220 kΩ)
R22	7030003560	S.RESISTOR	ERJ3GEYJ 103 V (10 kΩ)
R23	7030003720	S.RESISTOR	ERJ3GEYJ 224 V (220 kΩ)
R25	7030003520	S.RESISTOR	ERJ3GEYJ 472 V (4.7 kΩ)
R29	7030003340	S.RESISTOR	ERJ3GEYJ 151 V (150 Ω)
R30	7030003440	S.RESISTOR	ERJ3GEYJ 102 V (1 kΩ)
R31	7030003320	S.RESISTOR	ERJ3GEYJ 101 V (100 Ω)
R32	7030003320	S.RESISTOR	ERJ3GEYJ 101 V (100 Ω)
R33	7030003340	S.RESISTOR	ERJ3GEYJ 151 V (150 Ω)
R34	7030003690	S.RESISTOR	ERJ3GEYJ 124 V (120 kΩ)
R35	7030003320	S.RESISTOR	ERJ3GEYJ 101 V (100 Ω)
R36	7030003510	S.RESISTOR	ERJ3GEYJ 392 V (3.9 kΩ)
R37	7030003500	S.RESISTOR	ERJ3GEYJ 332 V (3.3 kΩ) (J)
	7030003520	S.RESISTOR	ERJ3GEYJ 472 V (4.7 kΩ) (K)
R38	7030003680	S.RESISTOR	ERJ3GEYJ 104 V (100 kΩ)
R39	7030003280	S.RESISTOR	ERJ3GEYJ 470 V (47 Ω)
R40	7030003340	S.RESISTOR	ERJ3GEYJ 151 V (150 Ω)
R43	7030003280	S.RESISTOR	ERJ3GEYJ 470 V (47 Ω)
R44	7030003680	S.RESISTOR	ERJ3GEYJ 104 V (100 kΩ)
R45	7030003700	S.RESISTOR	ERJ3GEYJ 154 V (150 kΩ)
R46	7030003400	S.RESISTOR	ERJ3GEYJ 471 V (470 Ω)
R48	7030003660	S.RESISTOR	ERJ3GEYJ 683 V (68 kΩ) (B) only
R49	7520000230	S.POSISTOR	PRF18BD471QB1RB (B) only
R50	7030003320	S.RESISTOR	ERJ3GEYJ 101 V (100 Ω)
R51	7030003750	S.RESISTOR	ERJ3GEYJ 394 V (390 kΩ) (B)
	7030003760	S.RESISTOR	ERJ3GEYJ 474 V (470 kΩ) (A)
R52	7030003720	S.RESISTOR	ERJ3GEYJ 224 V (220 kΩ)
R53	7030003400	S.RESISTOR	ERJ3GEYJ 471 V (470 Ω) (B)
	7030003410	S.RESISTOR	ERJ3GEYJ 561 V (560 Ω) (A)
R54	7030003560	S.RESISTOR	ERJ3GEYJ 103 V (10 kΩ)
R55	7030003440	S.RESISTOR	ERJ3GEYJ 102 V (1 kΩ)
R56	7030003700	S.RESISTOR	ERJ3GEYJ 154 V (150 kΩ)
R57	7030003560	S.RESISTOR	ERJ3GEYJ 103 V (10 kΩ)
R58	7030003320	S.RESISTOR	ERJ3GEYJ 101 V (100 Ω)
R59	7030003690	S.RESISTOR	ERJ3GEYJ 124 V (120 kΩ) (A)
	7030003720	S.RESISTOR	ERJ3GEYJ 224 V (220 kΩ) (B)
R61	7030003300	S.RESISTOR	ERJ3GEYJ 680 V (68 Ω)
R62	7030003600	S.RESISTOR	ERJ3GEYJ 223 V (22 kΩ)
R65	7030003360	S.RESISTOR	ERJ3GEYJ 221 V (220 Ω)
R66	7030003680	S.RESISTOR	ERJ3GEYJ 104 V (100 kΩ)
R67	7030003320	S.RESISTOR	ERJ3GEYJ 101 V (100 Ω)
R68	7030003560	S.RESISTOR	ERJ3GEYJ 103 V (10 kΩ)
R69	7030003520	S.RESISTOR	ERJ3GEYJ 472 V (4.7 kΩ)
R70	7030003200	S.RESISTOR	ERJ3GEYJ 100 V (10 Ω)
R71	7030003260	S.RESISTOR	ERJ3GEYJ 330 V (33 Ω)
R72	7030003400	S.RESISTOR	ERJ3GEYJ 471 V (470 Ω)
R73	7030003320	S.RESISTOR	ERJ3GEYJ 101 V (100 Ω)
R74	7030003680	S.RESISTOR	ERJ3GEYJ 104 V (100 kΩ)
R75	7030003700	S.RESISTOR	ERJ3GEYJ 154 V (150 kΩ)
R76	7030003360	S.RESISTOR	ERJ3GEYJ 221 V (220 Ω)

- (A): IC-F210S (25 W)
- (B): IC-F211S/F221S (45 W)
- (C): IC-F210S for [EUR]
- (D): IC-F221S for [USA]
- (E): IC-F210S/F211S for [GEN]
- (F): IC-F210S for high band
- (G): IC-F211S/221S for high band
- (H): IC-F210S for low band

[MAIN UNIT]

REF NO.	ORDER NO.	DESCRIPTION	
R77	7030003560	S.RESISTOR	ERJ3GEYJ 103 V (10 kΩ)
R78	7030003440	S.RESISTOR	ERJ3GEYJ 102 V (1 kΩ)
R79	7030005341	S.RESISTOR	ERA3YED 332V
R80	7030003440	S.RESISTOR	ERJ3GEYJ 102 V (1 kΩ)
R81	7030004040	S.RESISTOR	ERJ3GEYJ 4R7 V (4.7 Ω)
R82	7030004040	S.RESISTOR	ERJ3GEYJ 4R7 V (4.7 Ω)
R83	7030005341	S.RESISTOR	ERA3YED 332V
R84	7030005341	S.RESISTOR	ERA3YED 332V
R85	7030005341	S.RESISTOR	ERA3YED 332V
R86	7030003720	S.RESISTOR	ERJ3GEYJ 224 V (220 kΩ)
R87	7030003200	S.RESISTOR	ERJ3GEYJ 100 V (10 Ω)
R89	7030003560	S.RESISTOR	ERJ3GEYJ 103 V (10 kΩ)
R90	7030003760	S.RESISTOR	ERJ3GEYJ 474 V (470 kΩ)
R91	7030003590	S.RESISTOR	ERJ3GEYJ 183 V (18 kΩ) (H, I)
	7030003640	S.RESISTOR	ERJ3GEYJ 473 V (47 kΩ) (F, G)
R92	7030003690	S.RESISTOR	ERJ3GEYJ 124 V (120 kΩ)
R93	7030003440	S.RESISTOR	ERJ3GEYJ 102 V (1 kΩ)
R95	7030003560	S.RESISTOR	ERJ3GEYJ 103 V (10 kΩ)
R96	7030003510	S.RESISTOR	ERJ3GEYJ 392 V (3.9 kΩ)
R97	7030003440	S.RESISTOR	ERJ3GEYJ 102 V (1 kΩ)
R98	7030003480	S.RESISTOR	ERJ3GEYJ 222 V (2.2 kΩ)
R100	7030003640	S.RESISTOR	ERJ3GEYJ 473 V (47 kΩ)
R101	7030003440	S.RESISTOR	ERJ3GEYJ 102 V (1 kΩ)
R103	7030003700	S.RESISTOR	ERJ3GEYJ 154 V (150 kΩ)
R104	7030003450	S.RESISTOR	ERJ3GEYJ 122 V (1.2 kΩ)
R105	7030003640	S.RESISTOR	ERJ3GEYJ 473 V (47 kΩ)
R106	7030003670	S.RESISTOR	ERJ3GEYJ 823 V (82 kΩ)
R110	7030003280	S.RESISTOR	ERJ3GEYJ 470 V (47 Ω)
R111	7030006571	S.RESISTOR	ERA3YED 392V
R112	7030008071	S.RESISTOR	ERA3YED 273V
R113	7030008061	S.RESISTOR	ERA3YED 222V
R114	7030003570	S.RESISTOR	ERJ3GEYJ 123 V (12 kΩ)
R115	7030003490	S.RESISTOR	ERJ3GEYJ 272 V (2.7 kΩ)
R116	7030003570	S.RESISTOR	ERJ3GEYJ 123 V (12 kΩ)
R117	7030003710	S.RESISTOR	ERJ3GEYJ 184 V (180 kΩ)
R118	7030003570	S.RESISTOR	ERJ3GEYJ 123 V (12 kΩ)
R119	7030003530	S.RESISTOR	ERJ3GEYJ 562 V (5.6 kΩ)
R120	7030003560	S.RESISTOR	ERJ3GEYJ 103 V (10 kΩ)
R121	7030003520	S.RESISTOR	ERJ3GEYJ 472 V (4.7 kΩ)
R122	7030003460	S.RESISTOR	ERJ3GEYJ 152 V (1.5 kΩ)
R124	7030003520	S.RESISTOR	ERJ3GEYJ 472 V (4.7 kΩ)
R125	7030003680	S.RESISTOR	ERJ3GEYJ 104 V (100 kΩ)
R126	7030003400	S.RESISTOR	ERJ3GEYJ 471 V (470 Ω)
R127	7030003630	S.RESISTOR	ERJ3GEYJ 393 V (39 kΩ)
R128	7030003560	S.RESISTOR	ERJ3GEYJ 103 V (10 kΩ)
R129	7030003320	S.RESISTOR	ERJ3GEYJ 101 V (100 Ω)
R130	7030003560	S.RESISTOR	ERJ3GEYJ 103 V (10 kΩ)
R133	7030003710	S.RESISTOR	ERJ3GEYJ 184 V (180 kΩ)
R134	7030003650	S.RESISTOR	ERJ3GEYJ 563 V (56 kΩ)
R135	7030003690	S.RESISTOR	ERJ3GEYJ 124 V (120 kΩ)
R137	7030003660	S.RESISTOR	ERJ3GEYJ 683 V (68 kΩ)
R138	7030003680	S.RESISTOR	ERJ3GEYJ 104 V (100 kΩ)
R139	7030003680	S.RESISTOR	ERJ3GEYJ 104 V (100 kΩ)
R140	7030003680	S.RESISTOR	ERJ3GEYJ 104 V (100 kΩ)
R141	7410001130	S.ARRAY	EXB28V102JX
R142	7410001130	S.ARRAY	EXB28V102JX
R143	7410001130	S.ARRAY	EXB28V102JX
R144	7030003440	S.RESISTOR	ERJ3GEYJ 102 V (1 kΩ)
R145	7030003440	S.RESISTOR	ERJ3GEYJ 102 V (1 kΩ)
R146	7030003440	S.RESISTOR	ERJ3GEYJ 102 V (1 kΩ)
R147	7410001130	S.ARRAY	EXB28V102JX
R148	7410001130	S.ARRAY	EXB28V102JX
R149	7410001130	S.ARRAY	EXB28V102JX
R150	7410001130	S.ARRAY	EXB28V102JX
R156	7030003520	S.RESISTOR	ERJ3GEYJ 472 V (4.7 kΩ)
R159	7030003560	S.RESISTOR	ERJ3GEYJ 103 V (10 kΩ)
R161	7030003440	S.RESISTOR	ERJ3GEYJ 102 V (1 kΩ)
R162	7030003440	S.RESISTOR	ERJ3GEYJ 102 V (1 kΩ)
R163	7030003560	S.RESISTOR	ERJ3GEYJ 103 V (10 kΩ)
R164	7030003610	S.RESISTOR	ERJ3GEYJ 273 V (27 kΩ)
R183	7030003720	S.RESISTOR	ERJ3GEYJ 224 V (220 kΩ)
R184	7030003620	S.RESISTOR	ERJ3GEYJ 333 V (33 kΩ)
R185	7030003690	S.RESISTOR	ERJ3GEYJ 124 V (120 kΩ)
R186	7030003680	S.RESISTOR	ERJ3GEYJ 104 V (100 kΩ)
R187	7030003480	S.RESISTOR	ERJ3GEYJ 222 V (2.2 kΩ)
R188	7030003520	S.RESISTOR	ERJ3GEYJ 472 V (4.7 kΩ)
R191	7030003720	S.RESISTOR	ERJ3GEYJ 224 V (220 kΩ)
R192	7030003720	S.RESISTOR	ERJ3GEYJ 224 V (220 kΩ)
R193	7030003760	S.RESISTOR	ERJ3GEYJ 474 V (470 kΩ)
R194	7030003480	S.RESISTOR	ERJ3GEYJ 222 V (2.2 kΩ)

- (I): IC-F221S for low band
- (J): Narrow/wide version
- (K): Narrow/middle version
- S.=Surface mount

[MAIN UNIT]

REF NO.	ORDER NO.	DESCRIPTION	
R195	7030003490	S.RESISTOR	ERJ3GEYJ 272 V (2.7 kΩ)
R196	7030003560	S.RESISTOR	ERJ3GEYJ 103 V (10 kΩ)
R197	7030003560	S.RESISTOR	ERJ3GEYJ 103 V (10 kΩ)
R198	7030003560	S.RESISTOR	ERJ3GEYJ 103 V (10 kΩ)
R199	7030003560	S.RESISTOR	ERJ3GEYJ 103 V (10 kΩ)
R200	7030003560	S.RESISTOR	ERJ3GEYJ 103 V (10 kΩ)
R201	7030003400	S.RESISTOR	ERJ3GEYJ 471 V (470 Ω)
R202	7030000440	S.RESISTOR	MCR10EZHJ 3.3 kΩ
R203	7030000440	S.RESISTOR	MCR10EZHJ 3.3 kΩ
R204	7030003520	S.RESISTOR	ERJ3GEYJ 472 V (4.7 kΩ)
R205	7030003560	S.RESISTOR	ERJ3GEYJ 103 V (10 kΩ)
R206	7030003760	S.RESISTOR	ERJ3GEYJ 474 V (470 kΩ)
R207	7030003720	S.RESISTOR	ERJ3GEYJ 224 V (220 kΩ)
R208	7030000440	S.RESISTOR	MCR10EZHJ 3.3 kΩ
R209	7510001470	S.THERMISTOR	NTCG20 4AG 473JT
R210	7030005871	S.RESISTOR	ERA3YKD 104V (100 kΩ)
R211	7030003290	S.RESISTOR	ERJ3GEYJ 560 V (56 Ω)
R215	7030003400	S.RESISTOR	ERJ3GEYJ 471 V (470 Ω)
R217	7030003600	S.RESISTOR	ERJ3GEYJ 223 V (22 kΩ)
R218	7030003600	S.RESISTOR	ERJ3GEYJ 223 V (22 kΩ)
R219	7030003680	S.RESISTOR	ERJ3GEYJ 104 V (100 kΩ)
R220	7030003680	S.RESISTOR	ERJ3GEYJ 104 V (100 kΩ)
R222	7030003560	S.RESISTOR	ERJ3GEYJ 103 V (10 kΩ)
R223	7030003440	S.RESISTOR	ERJ3GEYJ 102 V (1 kΩ)
R224	7030003280	S.RESISTOR	ERJ3GEYJ 470 V (47 Ω)
R225	7030003560	S.RESISTOR	ERJ3GEYJ 103 V (10 kΩ)
R226	7030003680	S.RESISTOR	ERJ3GEYJ 104 V (100 kΩ)
R227	7030003800	S.RESISTOR	ERJ3GEYJ 105 V (1 MΩ)
R228	7030003680	S.RESISTOR	ERJ3GEYJ 104 V (100 kΩ)
R229	7030003800	S.RESISTOR	ERJ3GEYJ 105 V (1 MΩ)
R230	7030003570	S.RESISTOR	ERJ3GEYJ 123 V (12 kΩ)
R231	7030004050	S.RESISTOR	ERJ3GEYJ 1R0 V (1 Ω)
R232	7030003630	S.RESISTOR	ERJ3GEYJ 393 V (39 kΩ)
R234	7030003640	S.RESISTOR	ERJ3GEYJ 473 V (47 kΩ)
R235	7030003560	S.RESISTOR	ERJ3GEYJ 103 V (10 kΩ)
R236	7030003450	S.RESISTOR	ERJ3GEYJ 122 V (1.2 kΩ)
R237	7030003780	S.RESISTOR	ERJ3GEYJ 684 V (680 kΩ)
R238	7030003680	S.RESISTOR	ERJ3GEYJ 104 V (100 kΩ)
R240	7030003680	S.RESISTOR	ERJ3GEYJ 104 V (100 kΩ)
R241	7030003680	S.RESISTOR	ERJ3GEYJ 104 V (100 kΩ)
R242	7030003630	S.RESISTOR	ERJ3GEYJ 393 V (39 kΩ)
R243	7030003670	S.RESISTOR	ERJ3GEYJ 823 V (82 kΩ)
R244	7030003750	S.RESISTOR	ERJ3GEYJ 394 V (390 kΩ)
R245	7030003710	S.RESISTOR	ERJ3GEYJ 184 V (180 kΩ)
R246	7030003460	S.RESISTOR	ERJ3GEYJ 152 V (1.5 kΩ)
R247	7030003600	S.RESISTOR	ERJ3GEYJ 223 V (22 kΩ)
R248	7030003600	S.RESISTOR	ERJ3GEYJ 223 V (22 kΩ)
R249	7030003600	S.RESISTOR	ERJ3GEYJ 223 V (22 kΩ)
R250	7030003680	S.RESISTOR	ERJ3GEYJ 104 V (100 kΩ)
R251	7030003760	S.RESISTOR	ERJ3GEYJ 474 V (470 kΩ)
R252	7030003400	S.RESISTOR	ERJ3GEYJ 471 V (470 Ω)
R261	7030003800	S.RESISTOR	ERJ3GEYJ 105 V (1 MΩ)
R262	7030003800	S.RESISTOR	ERJ3GEYJ 105 V (1 MΩ)
R263	7030003800	S.RESISTOR	ERJ3GEYJ 105 V (1 MΩ)
R264	7030003660	S.RESISTOR	ERJ3GEYJ 683 V (68 kΩ)
R265	7030003590	S.RESISTOR	ERJ3GEYJ 183 V (18 kΩ)
R266	7030003640	S.RESISTOR	ERJ3GEYJ 473 V (47 kΩ)
R267	7030003610	S.RESISTOR	ERJ3GEYJ 273 V (27 kΩ)
R268	7030003560	S.RESISTOR	ERJ3GEYJ 103 V (10 kΩ)
R269	7030003680	S.RESISTOR	ERJ3GEYJ 104 V (100 kΩ)
R270	7030003680	S.RESISTOR	ERJ3GEYJ 104 V (100 kΩ)
R271	7030003320	S.RESISTOR	ERJ3GEYJ 101 V (100 Ω)
R285	7030003320	S.RESISTOR	ERJ3GEYJ 101 V (100 Ω)
R287	7030003560	S.RESISTOR	ERJ3GEYJ 103 V (10 kΩ)
R290	7030003320	S.RESISTOR	ERJ3GEYJ 101 V (100 Ω)
R291	7030003680	S.RESISTOR	ERJ3GEYJ 104 V (100 kΩ)
R292	7030003550	S.RESISTOR	ERJ3GEYJ 822 V (8.2 kΩ)
R297	7030003570	S.RESISTOR	ERJ3GEYJ 123 V (12 kΩ)
R298	7030005651	S.RESISTOR	ERA3YKD 304V (300 kΩ)
R299	7030005871	S.RESISTOR	ERA3YKD 104V (100 kΩ)
R304	7030003620	S.RESISTOR	ERJ3GEYJ 333 V (33 kΩ)
R305	7030003560	S.RESISTOR	ERJ3GEYJ 103 V (10 kΩ)
R306	7030004050	S.RESISTOR	ERJ3GEYJ 1R0 V (1 Ω)
R308	7030003490	S.RESISTOR	ERJ3GEYJ 272 V (2.7 kΩ)
R315	7030003680	S.RESISTOR	ERJ3GEYJ 104 V (100 kΩ)
R321	7030003340	S.RESISTOR	ERJ3GEYJ 151 V (150 Ω) (A) only
C1	4030011040	S.CERAMIC	GRM31M4C2H2R0CY21L (B)
	4030011100	S.CERAMIC	GRM31M2C2H8R0DV01L (A)

- (A): IC-F210S (25 W)
- (B): IC-F211S/F221S (45 W)
- (C): IC-F210S for [EUR]
- (D): IC-F221S for [USA]
- (E): IC-F210S/F211S for [GEN]
- (F): IC-F210S for high band
- (G): IC-F211S/221S for high band
- (H): IC-F210S for low band

[MAIN UNIT]

REF NO.	ORDER NO.	DESCRIPTION	
C2	4030011060	S.CERAMIC	GRM31M2C2H4R0CY21L (B)
	4030011080	S.CERAMIC	GRM31M2C2H6R0DV01L (A)
C3	4030006860	S.CERAMIC	C1608 JB 1H 102K-T
C4	4030006990	S.CERAMIC	C1608 CH 1H 080D-T (B)
	4030007010	S.CERAMIC	C1608 CH 1H 100D-T (A)
C5	4030006860	S.CERAMIC	C1608 JB 1H 102K-T
C6	4030011020	S.CERAMIC	GRM31M4C2H1R0CY21L
C7	4030011040	S.CERAMIC	GRM31M4C2H2R0CY21L
	4030011060	S.CERAMIC	GRM31M2C2H4R0CY21L (C), (I)
C8	4030011020	S.CERAMIC	GRM31M4C2H1R0CY21L
C9	4030011060	S.CERAMIC	GRM31M2C2H4R0CY21L
C10	4030006860	S.CERAMIC	C1608 JB 1H 102K-T
C11	4030006860	S.CERAMIC	C1608 JB 1H 102K-T
C12	4030011340	S.CERAMIC	C1608 CH 1H 471J-T
C13	4030007090	S.CERAMIC	C1608 CH 1H 470J-T
C14	4030011240	S.CERAMIC	GRM31M2C2H470JV01L
C15	4030009530	S.CERAMIC	C1608 CH 1H 030B-T (I)
	4030011770	S.CERAMIC	C1608 CH 1H 060B-T (A), (G)
C16	4030011030	S.CERAMIC	GRM31M4C2H1R5CY21L (G)
	4030011040	S.CERAMIC	GRM31M4C2H2R0CY21L (F), (I)
	4030011050	S.CERAMIC	GRM31M3C2H3R0CY21L (H)
C17	4030007110	S.CERAMIC	C1608 CH 1H 680J-T (C)
C18	4030009350	S.CERAMIC	C1608 CH 1H 3R5B-T (H), (I)
	4030009530	S.CERAMIC	C1608 CH 1H 030B-T (F), (G)
C19	4030006860	S.CERAMIC	C1608 JB 1H 102K-T
C20	4030009920	S.CERAMIC	C1608 CH 1H 050B-T (H), (I)
	4030011770	S.CERAMIC	C1608 CH 1H 060B-T (F), (G)
C21	4030009520	S.CERAMIC	C1608 CH 1H 020B-T
C22	4030009500	S.CERAMIC	C1608 CH 1H 0R5B-T
C25	4030009520	S.CERAMIC	C1608 CH 1H 020B-T
C26	4030006980	S.CERAMIC	C1608 CH 1H 070D-T
C27	4030006860	S.CERAMIC	C1608 JB 1H 102K-T
C28	4030006860	S.CERAMIC	C1608 JB 1H 102K-T
C29	4030009540	S.CERAMIC	C1608 CH 1H 1R5B-T
C30	4030009530	S.CERAMIC	C1608 CH 1H 030B-T (H)
	4030009920	S.CERAMIC	C1608 CH 1H 050B-T (B), (F)
C32	4030006860	S.CERAMIC	C1608 JB 1H 102K-T
C33	4030007090	S.CERAMIC	C1608 CH 1H 470J-T
C34	4030017460	S.CERAMIC	ECJ0EB1E102K
C35	4030011600	S.CERAMIC	C1608 JB 1E 104K-T
C36	4030006860	S.CERAMIC	C1608 JB 1H 102K-T
C37	4030006860	S.CERAMIC	C1608 JB 1H 102K-T
C38	4030006860	S.CERAMIC	C1608 JB 1H 102K-T
C39	4030009920	S.CERAMIC	C1608 CH 1H 050B-T (H), (I)
	4030011770	S.CERAMIC	C1608 CH 1H 060B-T (F), (G)
C40	4030009500	S.CERAMIC	C1608 CH 1H 0R5B-T
C41	4030007030	S.CERAMIC	C1608 CH 1H 150J-T
C42	4030006860	S.CERAMIC	C1608 JB 1H 102K-T
C43	4030006860	S.CERAMIC	C1608 JB 1H 102K-T
C44	4030009520	S.CERAMIC	C1608 CH 1H 020B-T (H), (I)
	4030009540	S.CERAMIC	C1608 CH 1H 1R5B-T (F), (G)
C45	4030006980	S.CERAMIC	C1608 CH 1H 070D-T (F), (G)
	4030011770	S.CERAMIC	C1608 CH 1H 060B-T (H), (I)
C48	4030007050	S.CERAMIC	C1608 CH 1H 220J-T
C49	4030006980	S.CERAMIC	C1608 CH 1H 070D-T (H), (I)
	4030009920	S.CERAMIC	C1608 CH 1H 050B-T (F), (G)
C50	4030006860	S.CERAMIC	C1608 JB 1H 102K-T
C51	4030006860	S.CERAMIC	C1608 JB 1H 102K-T
C52	4030007090	S.CERAMIC	C1608 CH 1H 470J-T
C53	4030006900	S.CERAMIC	C1608 JB 1H 103K-T
C54	4030006860	S.CERAMIC	C1608 JB 1H 102K-T
C56	4030007050	S.CERAMIC	C1608 CH 1H 220J-T
C57	4030006860	S.CERAMIC	C1608 JB 1H 102K-T
C58	4030006860	S.CERAMIC	C1608 JB 1H 102K-T
C59	4030006860	S.CERAMIC	C1608 JB 1H 102K-T
C60	4030006860	S.CERAMIC	C1608 JB 1H 102K-T
C61	4030007130	S.CERAMIC	C1608 CH 1H 101J-T
C62	4030007120	S.CERAMIC	C1608 CH 1H 820J-T
C63	4030007090	S.CERAMIC	C1608 CH 1H 470J-T
C64	4030006860	S.CERAMIC	C1608 JB 1H 102K-T
C65	4030006860	S.CERAMIC	C1608 JB 1H 102K-T
C66	4030006860	S.CERAMIC	C1608 JB 1H 102K-T
C67	4030006860	S.CERAMIC	C1608 JB 1H 102K-T
C69	4030011340	S.CERAMIC	C1608 CH 1H 471J-T
C70	4030011340	S.CERAMIC	C1608 CH 1H 471J-T
C71	4030011600	S.CERAMIC	C1608 JB 1E 104K-T
C72	4030006860	S.CERAMIC	C1608 JB 1H 102K-T (B) only
C73	4030017490	S.CERAMIC	C1608 JB 1A 105K-T
C75	4550006050	S.TANTALUM	TEMSVA OJ 106M8L
C76	4030006900	S.CERAMIC	C1608 JB 1H 103K-T

- (I): IC-F221S for low band
- (J): Narrow/wide version
- (K): Narrow/middle version

S.=Surface mount

[MAIN UNIT]

REF NO.	ORDER NO.	DESCRIPTION	
C77	4030006860	S.CERAMIC	C1608 JB 1H 102K-T
C78	4030006860	S.CERAMIC	C1608 JB 1H 102K-T
C79	4030011810	S.CERAMIC	C1608 JB 1A 224K-T
C80	4030006880	S.CERAMIC	C1608 JB 1H 472K-T
C81	4030006860	S.CERAMIC	C1608 JB 1H 102K-T
C82	4030011040	GRM31M4C2H2R0CY21L	(F)
	4030011050	S.CERAMIC	GRM31M3C2H3R0CY21L (B, H)
C83	4030011040	S.CERAMIC	GRM31M4C2H2R0CY21L (F)
	4030011050	S.CERAMIC	GRM31M3C2H3R0CY21L (B, H)
C84	4030007090	S.CERAMIC	C1608 CH 1H 470J-T
C85	4030006860	S.CERAMIC	C1608 JB 1H 102K-T
C86	4030007090	S.CERAMIC	C1608 CH 1H 470J-T
C87	4030006860	S.CERAMIC	C1608 JB 1H 102K-T
C88	4030007090	S.CERAMIC	C1608 CH 1H 470J-T
C89	4030009910	S.CERAMIC	C1608 CH 1H 040B-T (F, G)
	4030009920	S.CERAMIC	C1608 CH 1H 050B-T (H, I)
	4030009520	S.CERAMIC	C1608 CH 1H 020B-T
C91	4510005750	S.ELECTROLYTIC	ECEV1EA220SP
C92	4030006980	S.CERAMIC	C1608 CH 1H 070D-T
C93	4030009920	S.CERAMIC	C1608 CH 1H 050B-T
C94	4030009530	S.CERAMIC	C1608 CH 1H 030B-T (H, I)
	4030009550	S.CERAMIC	C1608 CH 1H 2R5B-T (F, G)
C95	4030009540	S.CERAMIC	C1608 CH 1H 1R5B-T
C96	4030006860	S.CERAMIC	C1608 JB 1H 102K-T
C97	4030007090	S.CERAMIC	C1608 CH 1H 470J-T
C98	4030009520	S.CERAMIC	C1608 CH 1H 020B-T
C99	4030006860	S.CERAMIC	C1608 JB 1H 102K-T
C100	4030007010	S.CERAMIC	C1608 CH 1H 100D-T
C101	4030006860	S.CERAMIC	C1608 JB 1H 102K-T
C102	4030007020	S.CERAMIC	C1608 CH 1H 120J-T
C103	4030009920	S.CERAMIC	C1608 CH 1H 050B-T
C104	4030006860	S.CERAMIC	C1608 JB 1H 102K-T
C105	4030006860	S.CERAMIC	C1608 JB 1H 102K-T
C106	4030007090	S.CERAMIC	C1608 CH 1H 470J-T
C107	4030006860	S.CERAMIC	C1608 JB 1H 102K-T
C108	4030006900	S.CERAMIC	C1608 JB 1H 103K-T
C109	4030006860	S.CERAMIC	C1608 JB 1H 102K-T
C110	4030011340	S.CERAMIC	C1608 CH 1H 471J-T
C111	4030007090	S.CERAMIC	C1608 CH 1H 470J-T
C112	4030011600	S.CERAMIC	C1608 JB 1E 104K-T
C113	4030009500	S.CERAMIC	C1608 CH 1H 0R5B-T
C114	4030006980	S.CERAMIC	C1608 CH 1H 070D-T
C115	4030009910	S.CERAMIC	C1608 CH 1H 040B-T
C116	4030006860	S.CERAMIC	C1608 JB 1H 102K-T
C117	4030011340	S.CERAMIC	C1608 CH 1H 471J-T
C118	4030009500	S.CERAMIC	C1608 CH 1H 0R5B-T
C119	4030006900	S.CERAMIC	C1608 JB 1H 103K-T
C120	4030011340	S.CERAMIC	C1608 CH 1H 471J-T
C121	4030007010	S.CERAMIC	C1608 CH 1H 100D-T
C122	4030011770	S.CERAMIC	C1608 CH 1H 060B-T
C123	4030007000	S.CERAMIC	C1608 CH 1H 090D-T (F, G)
	4030007010	S.CERAMIC	C1608 CH 1H 100D-T (H, I)
	4030009520	S.CERAMIC	C1608 CH 1H 020B-T (F, G)
	4030011770	S.CERAMIC	C1608 CH 1H 060B-T (H, I)
C125	4030008210	S.CERAMIC	C1608 UJ 1H 060D-T
C126	4030007010	S.CERAMIC	C1608 CH 1H 100D-T
C127	4030009500	S.CERAMIC	C1608 CH 1H 0R5B-T (F, G)
	4030009910	S.CERAMIC	C1608 CH 1H 040B-T (H, I)
C128	4030008190	S.CERAMIC	C1608 UJ 1H 040C-T
C129	4030009500	S.CERAMIC	C1608 CH 1H 0R5B-T
C130	4030008920	S.CERAMIC	C1608 JB 1H 473K-T
C131	4030006860	S.CERAMIC	C1608 JB 1H 102K-T
C132	4030006860	S.CERAMIC	C1608 JB 1H 102K-T
C133	4540000040	S.TRIMMER	ECR-KN006 A61X
C134	4540000040	S.TRIMMER	ECR-KN006 A61X
C138	4030006860	S.CERAMIC	C1608 JB 1H 102K-T
C139	4030011600	S.CERAMIC	C1608 JB 1E 104K-T
C140	4030011600	S.CERAMIC	C1608 JB 1E 104K-T
C141	4030006860	S.CERAMIC	C1608 JB 1H 102K-T
C142	4030006860	S.CERAMIC	C1608 JB 1H 102K-T
C143	4030006860	S.CERAMIC	C1608 JB 1H 102K-T
C144	4030007090	S.CERAMIC	C1608 CH 1H 470J-T
C145	4030007090	S.CERAMIC	C1608 CH 1H 470J-T
C146	4550000530	S.TANTALUM	TESVA 1V 104M1-8L
C147	4550003220	S.TANTALUM	TEMSVA 1E 105M-8L
C148	4510004630	S.ELECTROLYTIC	ECEV1CA100SR
C149	4030006860	S.CERAMIC	C1608 JB 1H 102K-T
C151	4030011600	S.CERAMIC	C1608 JB 1E 104K-T
C152	4030007090	S.CERAMIC	C1608 CH 1H 470J-T
C153	4030007090	S.CERAMIC	C1608 CH 1H 470J-T

- (A): IC-F210S (25 W)
- (C): IC-F210S for [EUR]
- (E): IC-F210S/F211S for [GEN]
- (G): IC-F211S/221S for high band
- (B): IC-F211S/F221S (45 W)
- (D): IC-F221S for [USA]
- (F): IC-F210S for high band
- (H): IC-F210S for low band

[MAIN UNIT]

REF NO.	ORDER NO.	DESCRIPTION	
C154	4030007090	S.CERAMIC	C1608 CH 1H 470J-T
C155	4030007090	S.CERAMIC	C1608 CH 1H 470J-T
C156	4030007090	S.CERAMIC	C1608 CH 1H 470J-T
C157	4030007130	S.CERAMIC	C1608 CH 1H 101J-T
C158	4030007130	S.CERAMIC	C1608 CH 1H 101J-T
C159	4030011600	S.CERAMIC	C1608 JB 1E 104K-T
C160	4030007000	S.CERAMIC	C1608 CH 1H 090D-T
C161	4030007130	S.CERAMIC	C1608 CH 1H 101J-T
C162	4030006900	S.CERAMIC	C1608 JB 1H 103K-T
C163	4510004630	S.ELECTROLYTIC	ECEV1CA100SR
C164	4030006860	S.CERAMIC	C1608 JB 1H 102K-T
C165	4030006900	S.CERAMIC	C1608 JB 1H 103K-T
C167	4030011600	S.CERAMIC	C1608 JB 1E 104K-T
C168	4030008920	S.CERAMIC	C1608 JB 1H 473K-T
C169	4030008920	S.CERAMIC	C1608 JB 1H 473K-T
C170	4030006860	S.CERAMIC	C1608 JB 1H 102K-T
C172	4030006880	S.CERAMIC	C1608 JB 1H 472K-T
C173	4030011600	S.CERAMIC	C1608 JB 1E 104K-T
C174	4510004630	S.ELECTROLYTIC	ECEV1CA100SR
C175	4030006860	S.CERAMIC	C1608 JB 1H 102K-T
C177	4030008770	S.CERAMIC	C1608 JB 1H 562K-T
C178	4030007160	S.CERAMIC	C1608 CH 1H 181J-T
C179	4030008850	S.CERAMIC	C1608 JB 1H 123K-T
C180	4510004640	S.ELECTROLYTIC	ECEV1CA470SP
C181	4030011600	S.CERAMIC	C1608 JB 1E 104K-T
C182	4030008770	S.CERAMIC	C1608 JB 1H 562K-T
C183	4030011600	S.CERAMIC	C1608 JB 1E 104K-T
C184	4030006860	S.CERAMIC	C1608 JB 1H 102K-T
C185	4030011280	S.CERAMIC	C1608 CH 1H 271J-T
C200	4030011600	S.CERAMIC	C1608 JB 1E 104K-T
C201	4030011600	S.CERAMIC	C1608 JB 1E 104K-T
C202	4030011600	S.CERAMIC	C1608 JB 1E 104K-T
C203	4030011600	S.CERAMIC	C1608 JB 1E 104K-T
C204	4030007090	S.CERAMIC	C1608 CH 1H 470J-T
C207	4030006860	S.CERAMIC	C1608 JB 1H 102K-T
C208	4030006860	S.CERAMIC	C1608 JB 1H 102K-T
C209	4030006860	S.CERAMIC	C1608 JB 1H 102K-T
C210	4030006860	S.CERAMIC	C1608 JB 1H 102K-T
C241	4030011050	S.CERAMIC	GRM31M3C2H3R0CY21L (B) only
C242	4030011050	S.CERAMIC	GRM31M3C2H3R0CY21L (B) only
C243	4030006880	S.CERAMIC	C1608 JB 1H 472K-T
C244	4030017480	S.CERAMIC	C1608 JB 1A 474K-T
C245	4030011600	S.CERAMIC	C1608 JB 1E 104K-T
C246	4030011600	S.CERAMIC	C1608 JB 1E 104K-T
C248	4030006860	S.CERAMIC	C1608 JB 1H 102K-T
C249	4030006870	S.CERAMIC	C1608 JB 1H 222K-T
C250	4030011600	S.CERAMIC	C1608 JB 1E 104K-T
C251	4030011600	S.CERAMIC	C1608 JB 1E 104K-T
C252	4030011600	S.CERAMIC	C1608 JB 1E 104K-T
C253	4030008880	S.CERAMIC	C1608 JB 1H 223K-T
C254	4030006860	S.CERAMIC	C1608 JB 1H 102K-T
C255	4510008030	S.ELECTROLYTIC	ECEV1EA471P
C256	4510006260	S.ELECTROLYTIC	ECEV1AA471UP
C258	4510008030	S.ELECTROLYTIC	ECEV1EA471P
C259	4030006860	S.CERAMIC	C1608 JB 1H 102K-T
C260	4030007090	S.CERAMIC	C1608 CH 1H 470J-T
C261	4030004760	S.CERAMIC	C2012 JF 1H 104Z-T
C262	4030011600	S.CERAMIC	C1608 JB 1E 104K-T
C263	4030004760	S.CERAMIC	C2012 JF 1H 104Z-T
C264	4030011600	S.CERAMIC	C1608 JB 1E 104K-T
C266	4510004630	S.ELECTROLYTIC	ECEV1CA100SR
C268	4550006700	S.TANTALUM	ECST1AY106R
C269	4030006860	S.CERAMIC	C1608 JB 1H 102K-T
C270	4030006860	S.CERAMIC	C1608 JB 1H 102K-T
C271	4510004630	S.ELECTROLYTIC	ECEV1CA100SR
C272	4510004630	S.ELECTROLYTIC	ECEV1CA100SR
C273	4030006860	S.CERAMIC	C1608 JB 1H 102K-T
C274	4510004630	S.ELECTROLYTIC	ECEV1CA100SR
C275	4030006860	S.CERAMIC	C1608 JB 1H 102K-T
C276	4030006860	S.CERAMIC	C1608 JB 1H 102K-T
C280	4030006900	S.CERAMIC	C1608 JB 1H 103K-T
C282	4030011600	S.CERAMIC	C1608 JB 1E 104K-T
C283	4030006860	S.CERAMIC	C1608 JB 1H 102K-T
C286	4030006900	S.CERAMIC	C1608 JB 1H 103K-T
C287	4030006860	S.CERAMIC	C1608 JB 1H 102K-T
C288	4030011600	S.CERAMIC	C1608 JB 1E 104K-T
C289	4030011600	S.CERAMIC	C1608 JB 1E 104K-T
C290	4030006860	S.CERAMIC	C1608 JB 1H 102K-T
C291	4030006860	S.CERAMIC	C1608 JB 1H 102K-T
C292	4030007090	S.CERAMIC	C1608 CH 1H 470J-T

- (1): IC-F221S for low band
- (J): Narrow/wide version
- (K): Narrow/middle version
- S.=Surface mount

[MAIN UNIT]

REF NO.	ORDER NO.	DESCRIPTION	
C293	4030006860	S.CERAMIC	C1608 JB 1H 102K-T
C294	4030006860	S.CERAMIC	C1608 JB 1H 102K-T
C295	4510004630	S.ELECTROLYTIC	ECEV1CA100SR
C297	4030007010	S.CERAMIC	C1608 CH 1H 100D-T
C298	4030006980	S.CERAMIC	C1608 CH 1H 070D-T
C299	4030006980	S.CERAMIC	C1608 CH 1H 070D-T
C301	4030011340	S.CERAMIC	C1608 CH 1H 471J-T
C302	4030009530	S.CERAMIC	C1608 CH 1H 030B-T
C303	4030006860	S.CERAMIC	C1608 JB 1H 102K-T
C304	4030007010	S.CERAMIC	C1608 CH 1H 100D-T
C305	4030007100	S.CERAMIC	C1608 CH 1H 560J-T
C306	4030009910	S.CERAMIC	C1608 CH 1H 040B-T
C307	4030006980	S.CERAMIC	C1608 CH 1H 070D-T
C308	4030009530	S.CERAMIC	C1608 CH 1H 030B-T
C309	4030006900	S.CERAMIC	C1608 JB 1H 103K-T
C310	4030006860	S.CERAMIC	C1608 JB 1H 102K-T
C311	4030006860	S.CERAMIC	C1608 JB 1H 102K-T
C314	4030006900	S.CERAMIC	C1608 JB 1H 103K-T
C315	4030008880	S.CERAMIC	C1608 JB 1H 223K-T
C316	4030009490	S.CERAMIC	C1608 JB 1H 821K-T
C317	4030009490	S.CERAMIC	C1608 JB 1H 821K-T
C318	4030011600	S.CERAMIC	C1608 JB 1E 104K-T
C319	4030008920	S.CERAMIC	C1608 JB 1H 473K-T
C320	4030008910	S.CERAMIC	C1608 JB 1H 393K-T
C321	4030011600	S.CERAMIC	C1608 JB 1E 104K-T
C322	4030006900	S.CERAMIC	C1608 JB 1H 103K-T
C324	4030011340	S.CERAMIC	C1608 CH 1H 471J-T
C325	4030006860	S.CERAMIC	C1608 JB 1H 102K-T
C327	4510004630	S.ELECTROLYTIC	ECEV1CA100SR
C328	4030007090	S.CERAMIC	C1608 CH 1H 470J-T
C329	4030006860	S.CERAMIC	C1608 JB 1H 102K-T
C331	4030009500	S.CERAMIC	C1608 CH 1H 0R5B-T
C333	4030007090	S.CERAMIC	C1608 CH 1H 470J-T
C334	4030006980	S.CERAMIC	C1608 CH 1H 070D-T
C335	4030007020	S.CERAMIC	C1608 CH 1H 120J-T
C336	4030007050	S.CERAMIC	C1608 CH 1H 220J-T
C337	4030006860	S.CERAMIC	C1608 JB 1H 102K-T
C339	4030009520	S.CERAMIC	C1608 CH 1H 020B-T
	4030009510	S.CERAMIC	C1608 CH 1H 010B-T
C342	4550002890	S.TANTALUM	TESVA 1A 225M1-8L
C343	4030006860	S.CERAMIC	C1608 JB 1H 102K-T
C344	4030006860	S.CERAMIC	C1608 JB 1H 102K-T
C345	4030011340	S.CERAMIC	C1608 CH 1H 471J-T
C346	4030007090	S.CERAMIC	C1608 CH 1H 470J-T
C348	4030006860	S.CERAMIC	C1608 JB 1H 102K-T
C349	4030011600	S.CERAMIC	C1608 JB 1E 104K-T
C350	4030017490	S.CERAMIC	C1608 JB 1A 105K-T
C351	4030008920	S.CERAMIC	C1608 JB 1H 473K-T
C352	4510005750	S.ELECTROLYTIC	ECEV1EA220SP
C357	4030011600	S.CERAMIC	C1608 JB 1E 104K-T
C359	4030017490	S.CERAMIC	C1608 JB 1A 105K-T
C360	4030006860	S.CERAMIC	C1608 JB 1H 102K-T
C361	4030011340	S.CERAMIC	C1608 CH 1H 471J-T
C362	4030007090	S.CERAMIC	C1608 CH 1H 470J-T
C363	4030006980	S.CERAMIC	C1608 CH 1H 070D-T
C364	4030006980	S.CERAMIC	C1608 CH 1H 070D-T
C365	4030011770	S.CERAMIC	C1608 CH 1H 060B-T
C373	4030007050	S.CERAMIC	C1608 CH 1H 220J-T
C374	4030007020	S.CERAMIC	C1608 CH 1H 120J-T
C375	4030006980	S.CERAMIC	C1608 CH 1H 070D-T
J1	6510018430	S.CONNECTOR	AXN330C038P
J2	6510022470	S.CONNECTOR	40FLT-SM1-TB
J4	6450000140	CONNECTOR	HSJ0807-01-010
J6	6510019250	S.CONNECTOR	B11B-ZR-SM3-TF
J7	6510014960	S.CONNECTOR	B2B-ZR-SM3-TF
W1	7120000470	JUMPER	ERDS2T0
W2	8900011861	CABLE	OPC-1195A

Ⓜ, Ⓛ
Ⓧ, Ⓨ

REF NO.	ORDER NO.	DESCRIPTION	
EP1	6910013370	S.BEAD	BLM18BB221SN1D
EP3	6910011560	BEAD	HF70BB4.5X5X1.6
EP4	6910010280	BEAD	HF70BB9.5X10.4X4.9
EP5	6910010280	BEAD	HF70BB9.5X10.4X4.9
EP6	0910055595	PCB	B 5895E

Ⓐ: IC-F210S (25 W) Ⓑ: IC-F211S/F221S (45 W)
 Ⓒ: IC-F210S for [EUR] Ⓓ: IC-F221S for [USA]
 Ⓔ: IC-F210S/F211S for [GEN] Ⓔ: IC-F210S for high band
 Ⓞ: IC-F211S/221S for high band Ⓜ: IC-F210S for low band

Ⓛ: IC-F221S for low band
 Ⓨ: Narrow/wide version
 Ⓧ: Narrow/middle version

S.=Surface mount

SECTION 7 MECHANICAL PARTS

[CHASSIS PARTS]

REF. NO.	ORDER NO.	DESCRIPTION	QTY.
J1	6510004880	Connector MR-DS-E 01	1
MP1	8010019060	2601 chassis [25W]	1
	8010019130	2601 long chassis [45W]	1
MP2	8110007820	2601 cover	1
MP3	8810008660	Screw PH BT M3 × 8 NI-ZU	8
MP4	8810008660	Screw PH BT M3 × 8 NI-ZU	2
MP5	8810008660	Screw PH BT M3 × 8 NI-ZU	2
MP6	8810008660	Screw PH BT M3 × 8 NI-ZU	1
MP7	8810009990	Screw PH BT M3 × 8 ZK	4
MP8	8810009990	Screw PH BT M3 × 8 ZK	2
MP10	8930058990	Shield sponge (V) [25W] only	2
MP11	8930058840	Shield sponge (T)	1
MP12	8930058840	Shield sponge (T)	1

[FRONT UNIT]

REF. NO.	ORDER NO.	DESCRIPTION	QTY.
R14	7210003020	Variable resistor EVU-F2KFK1B14	1
SP1	2510001220	Speaker C052SB500-13	1
J1	6450002210	Connector 3017-8821	1
W1	8900010500	Cable OPC-1046	1
MP1	8210019080	2601 front panel	1
MP2	8930058340	2601 front key	1
MP3	8310054410	2601 front plate	1
MP4	8210019090	2601 reflector	1
MP5	8610011180	Knob N292	1
MP7	8810008660	Screw PH BT M3 × 8 NI-ZU	2
MP8	8510015150	2602 F-shield	1
MP9	8930059000	2601 SP net	1
MP10	8810008660	Screw PH BT M3 × 8 NI-ZU	2

[MAIN UNIT]

REF. NO.	ORDER NO.	DESCRIPTION	QTY.
J4	6450000140	Connector HSJ0807-01-010	1
W2	8900011861	Cable OPC-1195A	1
MP1	8510005070	599 shield plate	1
MP2	8510011230	1923 VCO shield [25W] only	1
MP3	8930058840	Shield sponge (T)	1
MP4	8510014940	2601 VCO case	1
MP5	8510014950	2601 VCO cover	1
MP6	8510014910	2601 filter case	1
MP7	8510015110	2602 M-plate	1
MP8	8930058990	Shield sponge (V)	1
MP9	8510000210	194 shield plate [25W] only	1
MP10	8930059390	Shield sponge (Y) [25W] only	1
MP11	8930059490	2602 spring [EUR] only	1

[ACCESSORIES]

REF. NO.	ORDER NO.	DESCRIPTION	QTY.
MC1	0800005780	Microphone HM-100N	1
W1	8900011780	Cable OPC-1194 [25W]	1
	8900010990	Cable OPC-1132 [45W]	1
W2	8900000730	Cable OPC-049	1
MP1	8010019151	2601 mobil bracket-1	1
MP2	8930059160	2601 felt	2
MP3	8820000530	Flange volt M4 × 8 NI	4
MP4	8810000470	Screw PH M5 × 12 (+-)	4
MP5	8810005840	Screw PH A M5 × 20	4
MP6	8850000150	Flat washer M5 NI BS	4
MP7	8850000390	Spring washer M5	4
MP8	8830000120	Nut M5	4
MP9	6910004210	731 mic hanger set	1
MP10	8310054770	1705 LCD seal (F)	1

Screw abbreviations A,BT: Self-tapping PH: Pan head
 ZK: Black BS: Brass
 NI: Nickel NI-ZU: Nickel-Zinc

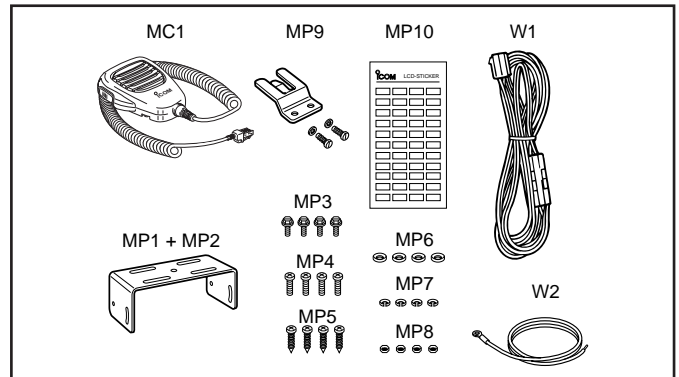

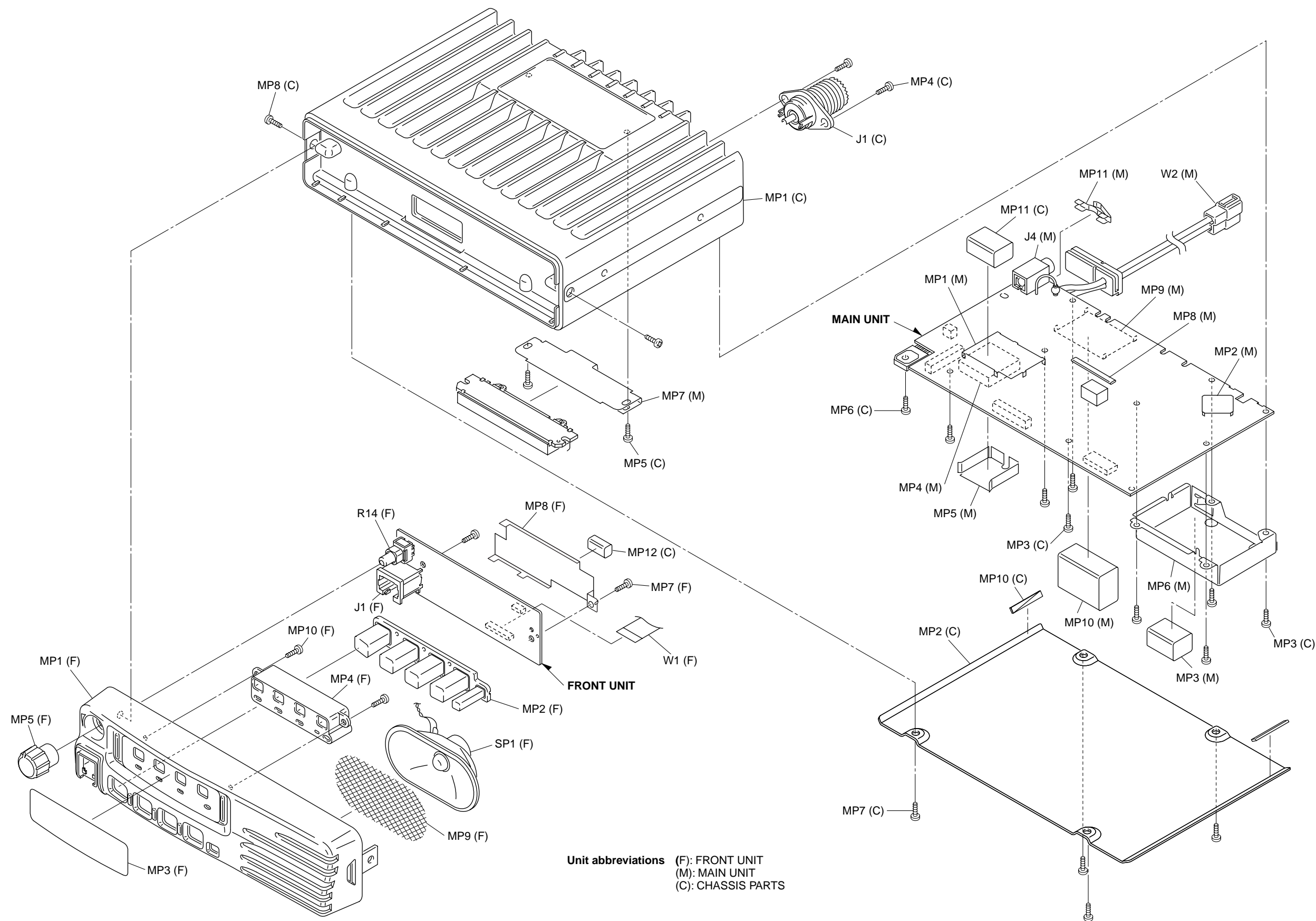

SECTION 8 SEMI-CONDUCTOR INFORMATION

• TRANSISTORS AND FET'S

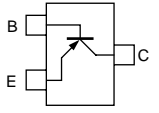
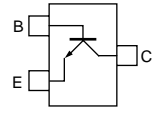
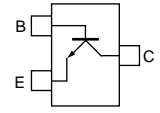
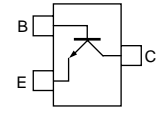
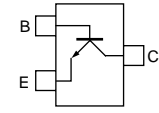
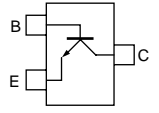
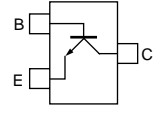
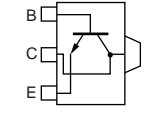
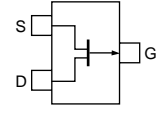
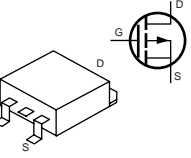
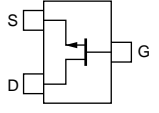
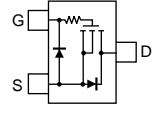
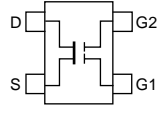
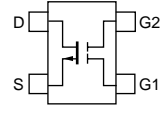
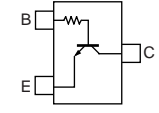
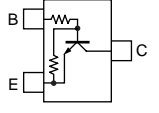
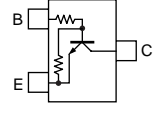
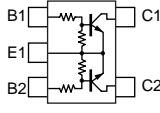
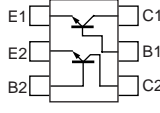
2SA1577 T106 Q (Symbol: HQ) 	2SC3356 T1B R25 (Symbol: R25) 	2SC4081 T106 R (Symbol: BR) 	2SC4116 BL (Symbol: LL) 	2SC4215 O (Symbol: QO) 
2SC4226 T1 R25 (Symbol: R25) 	2SC5107 O (Symbol: MFO) 	2SD1664 T100Q (Symbol: DAQ) 	2SJ144 GR (Symbol: VG) 	2SJ377 (Symbol: 4L) 
2SK880 Y (Symbol: XY) 	2SK1829 (Symbol: K1) 	3SK293 (Symbol: UF) 	3SK299 T1 U73 (Symbol: U73) 	DTC114TUA T106 (Symbol: 04) 
DTC144EUA T106 (Symbol: 26_) 	DTC363 EK (Symbol: H27) 	XP1214 (Symbol: 9H) 	XP6501 AB (Symbol: 5N) 	

• DIODES

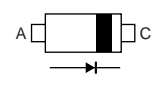
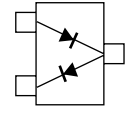
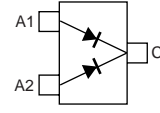
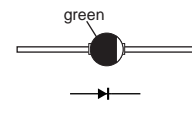
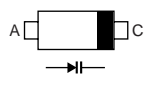
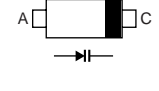
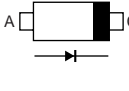
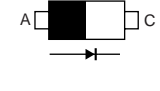
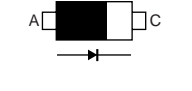
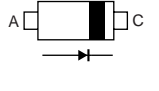
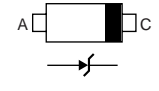
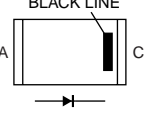
1SV307 (Symbol: TX) 	DA221 TL (Symbol: K) 	DAN222TL (Symbol: N) 	DSA3A1 (Color: Green) 	HVC350B (Symbol: B0) 
HVC362 (Symbol: V2) 	MA2S111 (Symbol: A) 	MA77 (Symbol: 4B) 	MA368 (Symbol: 6L) 	MA728 (Symbol: 2A) 
MA8056 M (Symbol: 5-6) 	UM9401F (Symbol: none) BLACK LINE 			

SECTION 9 BOARD LAYOUTS

9-1 FRONT UNIT • TOP VIEW

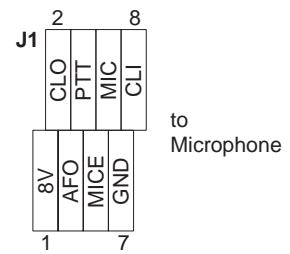
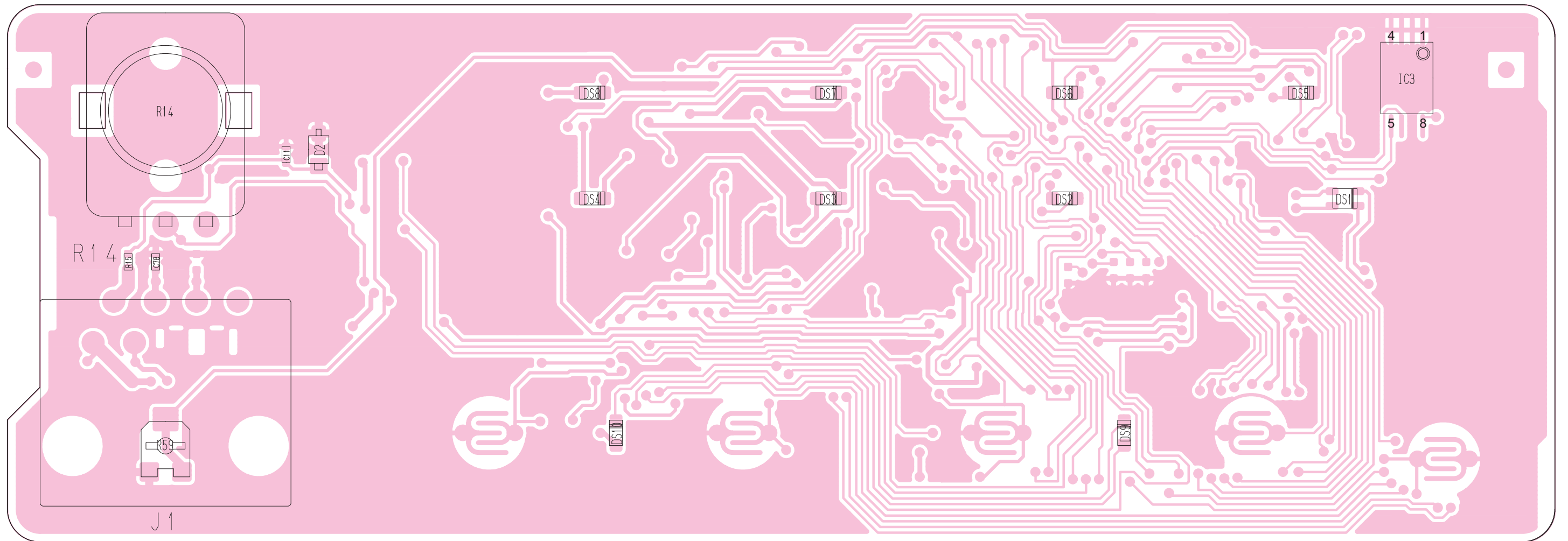

• BOTTOM VIEW (FRONT UNIT)

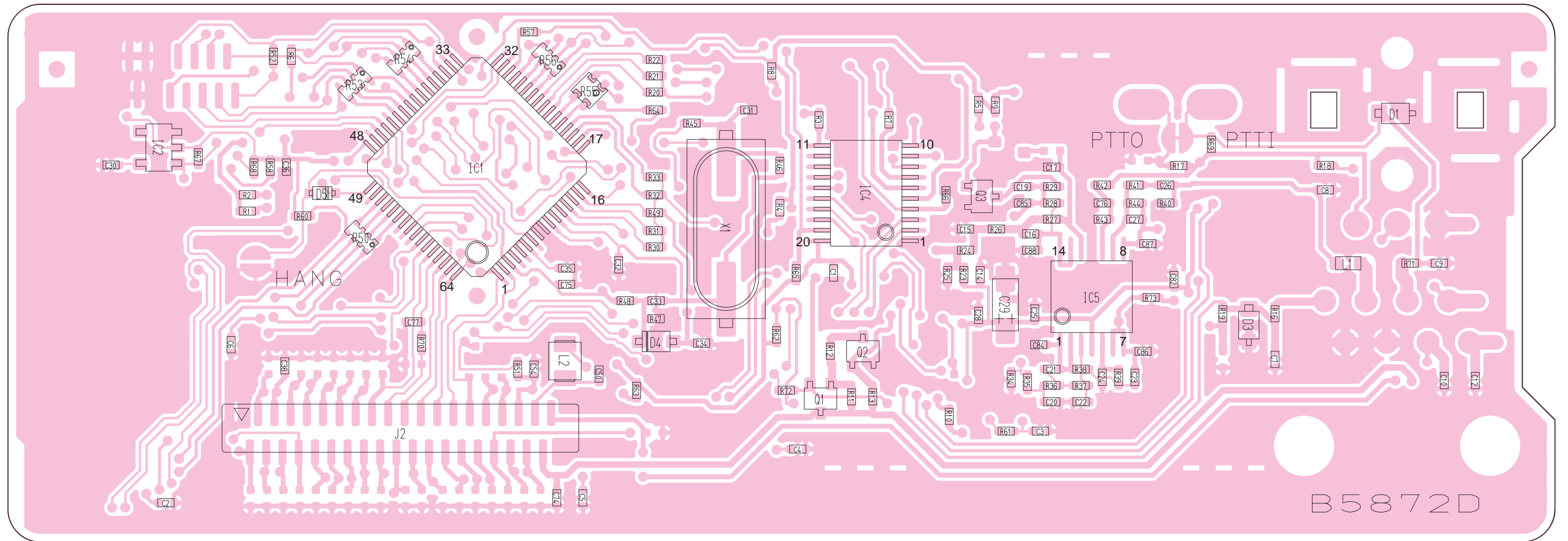

1	GND	39
2	DIM	GND
3	TONE	8V
4	TENC	5V
5	NOIS	BEEP
6	NWC	AFON
7	TMUT	RXC
8	UNLK	BATV
9	PLST	TEMP
10	CDEC	CCS
11	SCK	CIRQ
12	SI	OV12
13	SO	RSSI
14	OV12	LVIN
15	SI	OV12
16	SO	RSSI
17	OV12	LVIN
18	SI	OV12
19	SO	RSSI
20	OV12	LVIN
21	SI	OV12
22	SO	RSSI
23	OV12	LVIN
24	SI	OV12
25	SO	RSSI
26	OV12	LVIN
27	SI	OV12
28	SO	RSSI
29	OV12	LVIN
30	SI	OV12
31	SO	RSSI
32	OV12	LVIN
33	SI	OV12
34	SO	RSSI
35	OV12	LVIN
36	SI	OV12
37	SO	RSSI
38	OV12	LVIN
39	SI	OV12
40	SO	RSSI

to MAIN unit J2

9-2 MAIN UNIT
• TOP VIEW

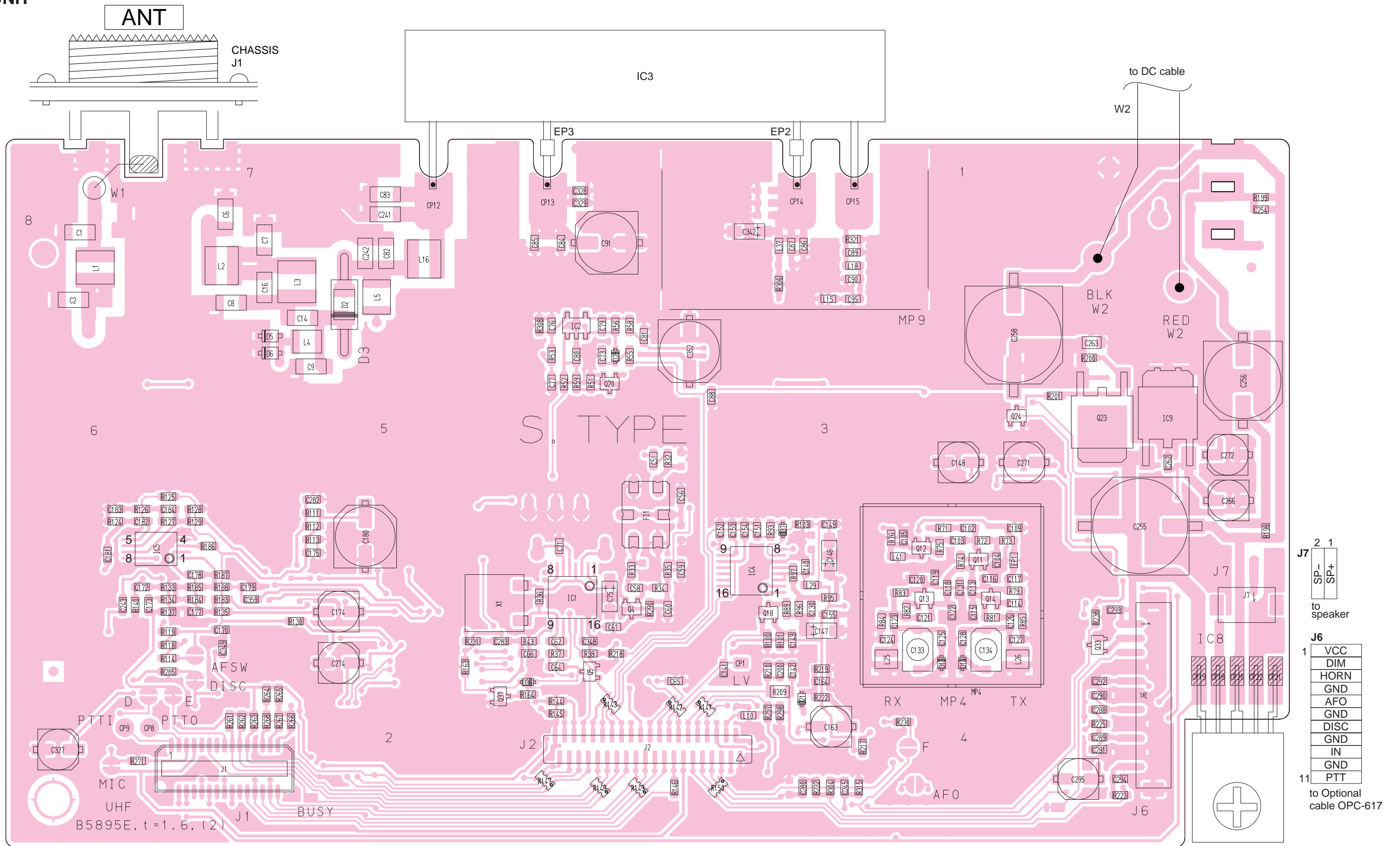

J1	1	PTTI	15
	2	PTTO	
	3	MCOT	
	4	MCIN	
	5	NC	
	6	AFONO	
	7	BEEPO	
	8	NC	
	9	DET	
	10	SIGO	
	11	OPT1	
	12	OPT2	
	13	OPT3	
	14	CCS	
	15	CIRQ	
	16	GND	
	17	SO	
	18	OPV3	
	19	SI	
	20	OPV2	
	21	SCK	
	22	OPV1	
	23		
	24		
	25		
	26		
	27		
	28		
	29		
	30	GND	

to Optional unit

J2	40	GND	2
	39	DIM	
	38	TONE	
	37	DAST	
	36	TENC	
	35	NOIS	
	34	NWC	
	33	MMUT	
	32	OPT3	
	31	OPT2	
	30	OPT1	
	29	PLST	
	28	UNLK	
	27	TMUT	
	26	UNLK	
	25	PLST	
	24	BUSY	
	23	SCK	
	22	CDEC	
	21	SI	
	20	SDEC	
	19	SO	
	18	OV12	
	17	RSSI	
	16	LVIN	
	15	CCS	
	14	MIC	
	13	TEMP	
	12	BATV	
	11	RXC	
	10	EPPT	
	9	HORNO	
	8	AFON	
	7	BEEP	
	6	PWON	
	5	5V	
	4	CPU5	
	3	8V	
	2	AFO	
	1	GND	

to FRONT unit J2

J7	2	1
	SP	+
	SP	-
	+	SP
	-	SP
	to speaker	
J6	1	VCC
	2	DIM
	3	HORN
	4	GND
	5	AFO
	6	GND
	7	DISC
	8	GND
	9	IN
	10	GND
	11	PTT
	to Optional cable OPC-617	

• BOTTOM VIEW (MAIN UNIT)

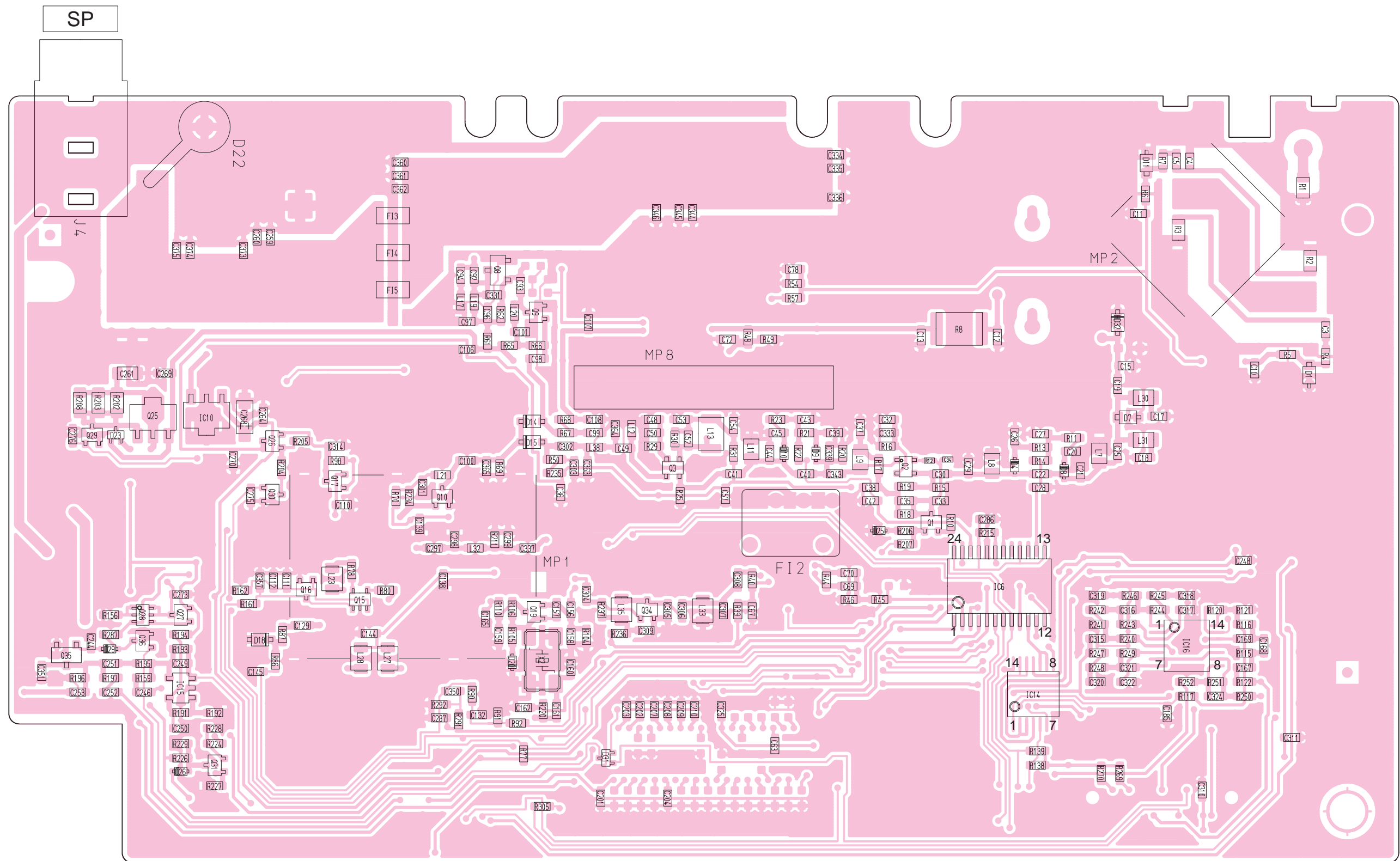

SECTION 11 VOLTAGE DIAGRAMS

11-1 FRONT UNIT

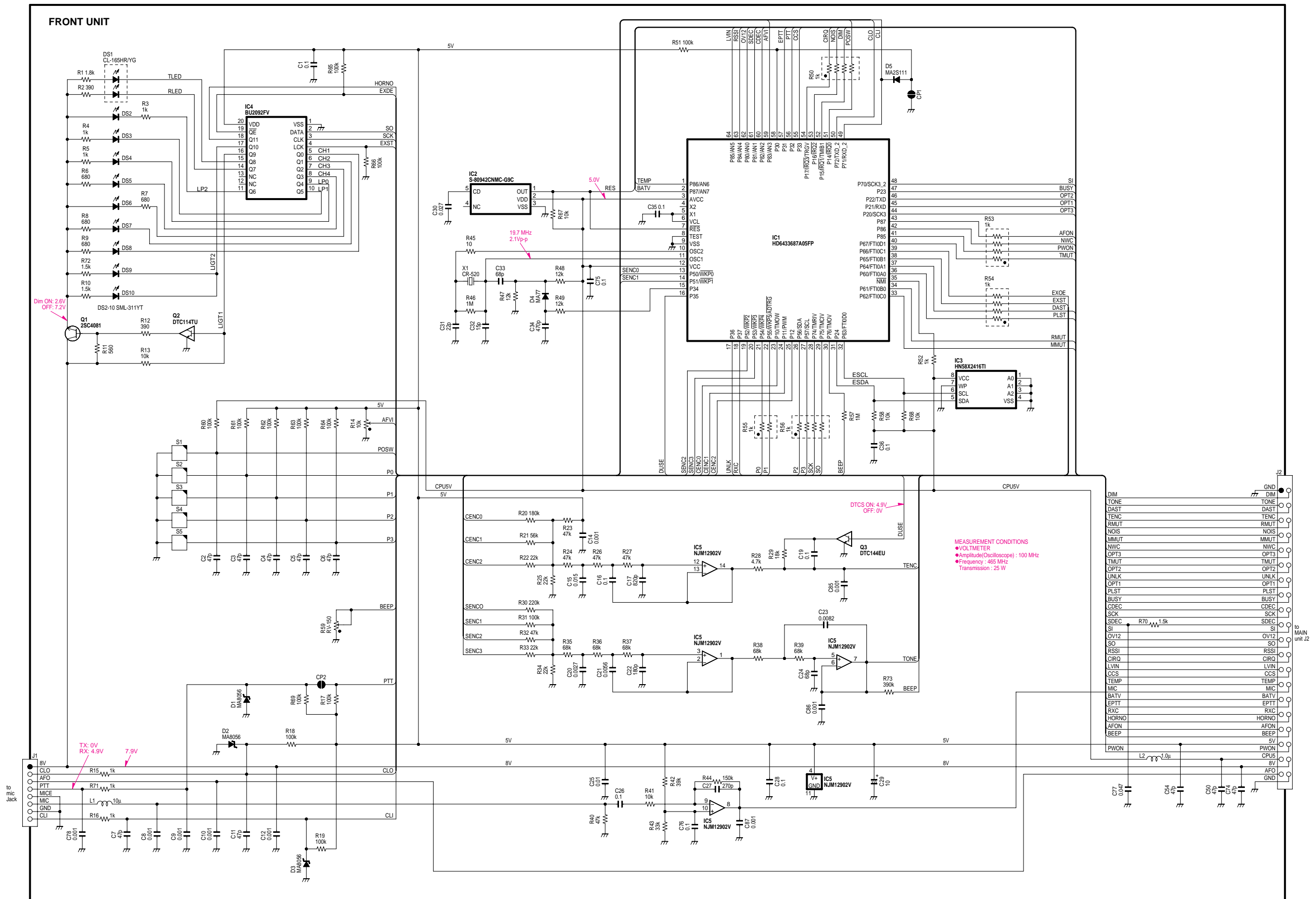

Icom Inc.

1-1-32, Kamiminami, Hirano-ku, Osaka 547-0003, Japan
Phone : 06 6793 5302
Fax : 06 6793 0013
URL : <http://www.icom.co.jp/world/index.html>

Icom America Inc.

<Corporate Headquarters>
2380 116th Avenue N.E., Bellevue, WA 98004, U.S.A.
Phone : (425) 454-8155 Fax : (425) 454-1509
URL : <http://www.icomamerica.com>
<Customer Service>
Phone : (425) 454-7619

Icom Canada

Glenwood Centre #150-6165
Highway 17 Delta, B.C., V4K 5B8, Canada
Phone : (604) 952-4266 Fax : (604) 952-0090
URL : <http://www.icomcanada.com>

Icom (Australia) Pty. Ltd.

A.B.N. 88 006 092 575
290-294 Albert Street, Brunswick, Victoria, 3056, Australia
Phone : 03 9387 0666 Fax : 03 9387 0022
URL : <http://www.icom.net.au>

Icom New Zealand

146A Harris Road, East Tamaki,
Auckland, New Zealand
Phone : 09 274 4062 Fax : 09 274 4708
URL : <http://www.icom.co.nz>

Beijing Icom Ltd.

1305, Wanshang Plaza, Shijingshan Road, Beijing China
Phone : (010) 6866 6337 Fax : (010) 6866 3553
URL : <http://www.bjicom.com>

Icom (Europe) GmbH

Communication Equipment
Himmelgeister Str. 100, D-40225 Düsseldorf, Germany
Phone : 0211 346047 Fax : 0211 333639
URL : <http://www.icomeurope.com>

Icom Spain S.L

Crta. de Gracia a Manresa Km. 14,750
08190 Sant Cugat del Valles Barcelona, SPAIN
Phone : (93) 590 26 70 Fax : (93) 589 04 46
URL : <http://www.icomspain.com>

Icom (UK) Ltd.

Unit 9, Sea St., Herne Bay, Kent, CT6 8LD, U.K.
Phone : 01227 741741 Fax : 01227 741742
URL : <http://www.icomuk.co.uk>

Icom France S.a

Zac de la Plaine, 1, Rue Brindejonc des Moulinais
BP 5804, 31505 Toulouse Cedex, France
Phone : (33) 5 61 36 03 03 Fax : (33) 5 61 36 03 00
URL : <http://www.icom-france.com>

Asia Icom Inc.

6F No. 68, Sec. 1 Cheng-Teh Road, Taipei, Taiwan, R.O.C.
Phone : (02) 2559 1899 Fax : (02) 2559 1874
URL : <http://www.asia-icom.com>

Count on us!

Icom Inc.

1-1-32, Kamiminami, Hirano-ku, Osaka 547-0003, Japan

S-13906HZ-C1US-②
© 2002, 2003 Icom Inc.

Free Manuals Download Website

<http://myh66.com>

<http://usermanuals.us>

<http://www.somanuals.com>

<http://www.4manuals.cc>

<http://www.manual-lib.com>

<http://www.404manual.com>

<http://www.luxmanual.com>

<http://aubethermostatmanual.com>

Golf course search by state

<http://golfingnear.com>

Email search by domain

<http://emailbydomain.com>

Auto manuals search

<http://auto.somanuals.com>

TV manuals search

<http://tv.somanuals.com>