

JVC[®]

Color Television Users Guide

For Models:

AV-27D304

AV-27D104

AV-20D304

AV-32430

AV-32432

AV-27430

AV-27432



Illustration of AV-27D304 and RM-C1253G

Important Note:

In the spaces below, enter the model and serial number of your television (located at the rear of the television cabinet). Staple your sales receipt or invoice to the inside cover of this guide. Keep this user's guide in a convenient place for future reference. Keep the carton and original packaging for future use.

Model Number: _____

Serial Number: _____

LCT1319-001A-A
0103-TN-II-IM

Important Safety Precautions



CAUTION
RISK OF ELECTRICAL SHOCK
DO NOT OPEN



CAUTION: To reduce the risk of electric shock. Do not remove cover (or back). No user serviceable parts inside. Refer servicing to qualified service personnel.



The lightning flash with arrowhead symbol, within an equilateral triangle is intended to alert the user to the presence of uninsulated “dangerous voltage” within the product’s enclosure that may be of sufficient magnitude to constitute a risk of electric shock to persons.



The exclamation point within an equilateral triangle is intended to alert the user to the presence of important operating and maintenance (servicing) instructions in the literature accompanying the appliance.

WARNING:

TO PREVENT FIRE OR SHOCK HAZARDS, DO NOT EXPOSE THIS TV SET TO RAIN OR MOISTURE.

CAUTION:

TO INSURE PERSONAL SAFETY, OBSERVE THE FOLLOWING RULES REGARDING THE USE OF THIS UNIT.

1. Operate only from the power source specified on the unit.
2. Avoid damaging the AC plug and power cord.
3. Avoid Improper installation and never position the unit where good ventilation is unattainable.
4. Do not allow objects or liquid into the cabinet openings.
5. In the event of trouble, unplug the unit and call a service technician. Do not attempt to repair it yourself or remove the rear cover.

Changes or modifications not approved by JVC could void the warranty.

- When you don't use this TV set for a long period of time, be sure to disconnect both the power plug from the AC outlet and antenna for your safety.
- To prevent electric shock do not use this polarized plug with an extension cord, receptacle or other outlet unless the blades can be fully inserted to prevent blade exposure.

IMPORTANT RECYCLING INFORMATION

This product utilizes both a Cathode Ray Tube (CRT) and other components that contain lead. Disposal of these materials may be regulated in your community due to environmental considerations. For disposal or recycling information, please contact your local authorities, or the Electronic Industries Alliance: <http://www.eiae.org>

CAUTION ON REPLACABLE LITHIUM BATTERY

The battery used in this device may present a fire or chemical burn hazard if mistreated. Do not recharge, disassemble, heat above 100°C or incinerate.

Replace battery with CR2032 Panasonic (Matsushita Electric) or Maxell is recommended.

Danger of explosion or risk of fire if the battery is incorrectly replaced.

- Dispose of used battery promptly.
- Keep away from children.
- Do not disassemble and do not dispose of in fire.



- As an "ENERGY STAR®" partner, JVC has determined that this product or product model meets the "ENERGY STAR®" guidelines for energy efficiency.

Important Safeguards

CAUTION:

Please read and retain for your safety.

Electrical energy can perform many useful functions. This TV set has been engineered and manufactured to assure your personal safety. But **improper use can result in potential electrical shock or fire hazards.** In order not to defeat the safeguards incorporated in this TV set, observe the following basic rules for its installation, use and servicing. Also follow all warnings and instructions marked on your TV set.

INSTALLATION

- 1 Your TV set is equipped with a polarized AC line plug (one blade of the plug is wider than the other). This safety feature allows the plug to fit into the power outlet only one way. Should you be unable to insert the plug fully into the outlet, try reversing the plug. Should it still fail to fit, contact your electrician.
- 2 Operate the TV set only from a power source as indicated on the TV set or refer to the operating instructions for this information. If you are not sure of the type of power supply to your home, consult your TV set dealer or local power company. For battery operation, refer to the operating instructions.
- 3 Overloaded AC outlets and extension cords are dangerous, and so are frayed power cords and broken plugs. They may result in a shock or fire hazard. Call your service technician for replacement.
- 4 Do not allow anything to rest on or roll over the power cord, and do not place the TV set where power cord is subject to traffic or abuse. This may result in a shock or fire hazard.
- 5 Do not use this TV set near water – for example, near a bathtub, washbowl, kitchen sink, or laundry tub, in a wet basement, or near swimming pool, etc.
- 6 If an outside antenna is connected to the TV set, be sure the antenna system is grounded so as to provide some protection against voltage surges and built-up static charges. Section 810 of the National Electrical Code provides information with respect to proper grounding of the mast and supporting structure, grounding of the lead-in wire to an antenna discharge unit, size of grounding conductors, location of antenna discharge unit, connection requirements for the grounding electrode.

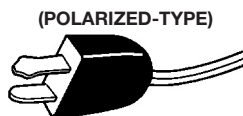

- 7 An outside antenna system should not be located in the vicinity of overhead power lines or other electric light or power circuits, or where it can fall into such power lines or circuits. When installing an outside antenna system, extreme care should be taken to keep from touching such power lines or circuits as contact with them might be fatal.

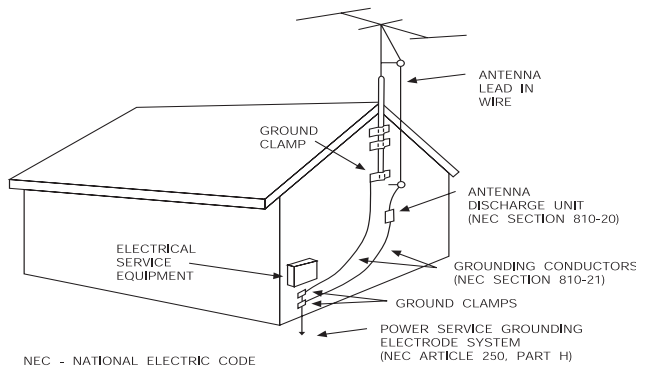

EXAMPLE OF ANTENNA GROUNDING AS PER NATIONAL ELECTRICAL CODE

- 8 TV sets are provided with ventilation openings in the cabinet to allow heat generated during operation to be released.

Therefore:

- Never block the bottom ventilation slots of a portable TV set by placing it on a bed, sofa, rug, etc.
- Never place a TV set in a "built-in" enclosure unless proper ventilation is provided.
- Never cover the openings with a cloth or other material.
- Never place the TV set near or over a radiator or heat register.

- 9 To avoid personal injury:

- Do not place a TV set on a sloping shelf unless properly secured.
- Use only a cart or stand recommended by the TV set manufacturer.
- Do not try to roll a cart with small casters across thresholds or deep pile carpets.
- Wall or shelf mounting should follow the manufacturer's instructions, and should use a mounting kit approved by the manufacturer.

Use

- 10 Caution children about dropping or pushing objects into the TV set through cabinet openings. Some internal parts carry hazardous voltages and contact can result in a fire or electrical shock.
- 11 Unplug the TV set from the wall outlet before cleaning. Do not use liquid or an aerosol cleaner.
- 12 Never add accessories to a TV set that has not been designed for this purpose. Such additions may result in a hazard.



PORTABLE CART WARNING (Symbol provided by RETAC)

- 13 For added protection of the TV set during a lightning storm or when the TV set is to be left unattended for an extended period of time, unplug it from the wall outlet and disconnect the antenna. This will prevent damage to product due to lightning storms or power line surges.
- 14 A TV set and cart combination should be moved with care. Quick stops, excessive force, and uneven surfaces may cause the TV set and cart combination to overturn.

Service

- 15 Unplug this TV set from the wall outlet and refer servicing to qualified service personnel under the following conditions:
 - A. When the power cord or plug is damaged or frayed.
 - B. If liquid has been spilled into the TV set.
 - C. If the TV set has been exposed to rain or water.
 - D. If the TV set does not operate normally by following the operating instructions. Adjust only those controls that are covered in the operating instructions as improper adjustment of other controls may result in damage and will often require extensive work by a qualified technician to restore the TV set to normal operation.
 - E. If the TV set has been dropped or damaged in any way.
 - F. When the TV set exhibits a distinct change in performance — this indicates a need for service.
- 16 Do not attempt to service this TV set yourself as opening or removing covers may expose you to dangerous voltage or other hazards. Refer all servicing to qualified service personnel.
- 17 When replacement parts are required, have the service technician verify in writing that the replacement parts he uses have the same safety characteristics as the original parts. Use of manufacturer's specified replacement parts can prevent fire, shock, or other hazards.
- 18 Upon completion of any service or repairs to this TV set, please ask the service technician to perform the safety check described in the manufacturer's service literature.
- 19 When a TV set reaches the end of its useful life, improper disposal could result in a picture tube implosion. Ask a qualified service technician to dispose of the TV set.
- 20 Note to CATV system installer.

This reminder is provided to call the CATV system installer's attention to Article 820-40 of the NEC that provides guidelines for proper grounding and, in particular, specifies that the cable ground shall be connected to the grounding system of the building, as close to the point of cable entry as practical.

How to use the remote.

Before using, insert the lithium battery – CR2032 – correctly, with the plus (+) side up into the battery compartment. To open it, press the release tab and carefully pull the compartment out. The remote control can operate most of your TV's functions, as well as basic functions of JVC VCRs.

* Point the remote towards the remote sensor on the target component. The maximum operating distance is about 8 meters.

* To operate a JVC VCR, use any of the following buttons:
VCR POWER, TV/VCR INPUT, VCR CH+/-, PLAY, REWIND, FAST-FORWARD, STOP, RECORD and PAUSE.

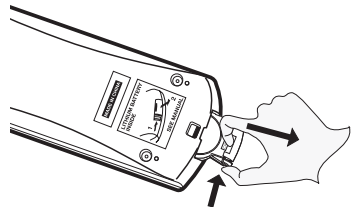

NOTE: If the remote does not work properly, remove the battery, wait for a few seconds, replace the battery and try again.

Table of Contents

Quick Setup 7

| | |
|------------------------------------|----|
| Unpacking your TV | 7 |
| TV Models | 8 |
| TV Remote Controls | 10 |
| Getting Started | 12 |
| The Remote Control | 12 |
| Connecting Your Devices | 13 |
| Interactive Plug In Menu | 17 |

Remote Programming 20

| | |
|---|----|
| Setting CATV, VCR and DVD Codes | 20 |
| CATV or Satellite Codes | 20 |
| VCR Codes | 21 |
| DVD Codes | 22 |
| Search Codes | 23 |

Onscreen Menus 24

| | |
|--------------------------------|----|
| Using the Guide | 24 |
| Onscreen Menu System | 25 |

Initial Setup 26

| | |
|----------------------------|----|
| Auto Tuner Setup | 26 |
| Channel Summary | 26 |
| V-Chip | 27 |
| Set Lock Code | 33 |
| Language | 34 |
| Closed Caption | 34 |
| XDS ID | 34 |
| Front Panel Lock | 35 |
| Auto Shut Off | 35 |

Picture Adjust 36

| | |
|-----------------------------------|----|
| Picture Settings | 36 |
| Adjust Picture Settings | 36 |
| Color Temperature | 37 |
| Noise Muting | 37 |

Sound Adjust 38

| | |
|-------------------------------------|----|
| Sound Settings | 38 |
| Adjust Sound Settings | 38 |
| MTS (Multi-channel Sound) | 38 |

Clock Timers 39

| | |
|------------------------|----|
| Set Clock | 39 |
| On/Off Timer | 40 |

Button Functions 41

| | |
|--------------------------------|----|
| Power | 41 |
| Number Buttons | 41 |
| Channel +/- | 41 |
| Volume +/- | 41 |
| 100+ Button | 41 |
| Menu | 41 |
| Exit | 41 |
| Return + | 42 |
| Sleep Timer | 42 |
| Muting | 42 |
| Display | 43 |
| Video Status | 43 |
| Sound | 44 |
| Hyper Surround | 44 |
| Game | 44 |
| TheaterPro D6500K | 45 |
| Input | 45 |
| C.C. | 45 |
| TV/CATV Slide Switch | 45 |
| VCR/DVD Slide Switch | 46 |
| VCR Buttons | 46 |
| DVD Buttons | 46 |
| Light | 46 |

Appendices 47

| | |
|--------------------------------------|----|
| Troubleshooting | 47 |
| Warranty | 48 |
| Authorized Service Centers | 50 |
| Specifications | 51 |

Quick Setup

Unpacking Your TV

Thank you for your purchase of a JVC Color Television. Before you begin setting up your new television, please check to make sure you have all of the following items. In addition to this guide, your television box should include:

1 Television

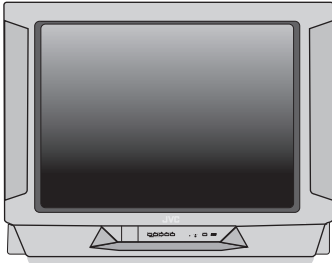

1 Remote Control

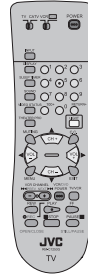

Two AA
Batteries
or
CR2032

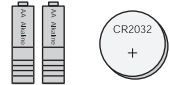

Note: Your television and/or remote control may differ from the examples illustrated here.

Once you have unpacked your television, the next step is to connect it to your antenna/cable or satellite system and to connect the audio/video devices you want to use with your television. To make these connections you will use plugs like the ones illustrated below.

Coaxial Cables



Used to connect an external antenna or cable TV system to your TV.

Component Cables Composite Cables Audio Cables



Used to connect audio/video devices like VCRs, DVD players, stereo amplifiers, game consoles, etc.

S-Video Cable



Used to make video connections with S-Video VCRs, Camcorders and DVD players.

We recommend that before you start using your new television, you read your entire User's Guide so you can learn about your new television's many great features. If you're anxious to start using your television right away, a quick setup guide follows on the next few pages.

NOTE: Before you connect your television to another device, please refer to the proper diagrams for your specific TV and remote. These will help assist you in understanding how to connect your television to another device, as well as use the remote to set up your television.

Rear Panel Diagrams

MODELS:
AV-27D304
AV-27D104
AV-20D304

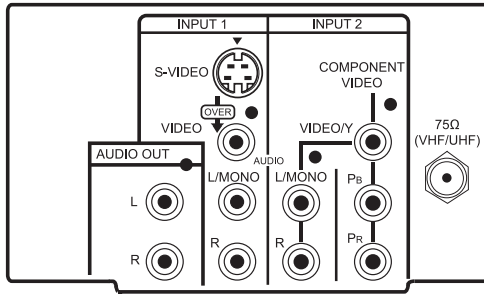

MODELS:
AV-27430
AV-27432

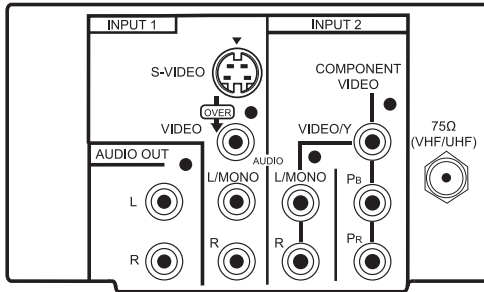

MODELS:
AV-32430
AV-32432

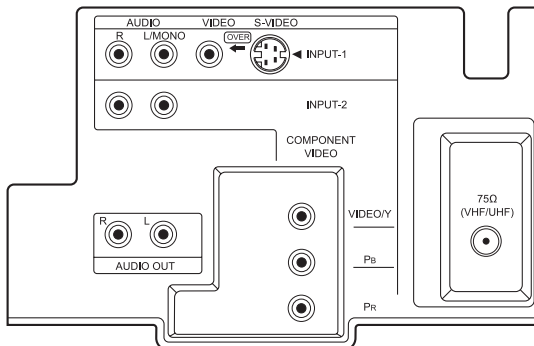

Front Panel Diagrams

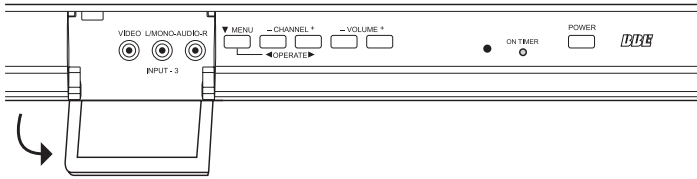

MODEL: AV-27D304

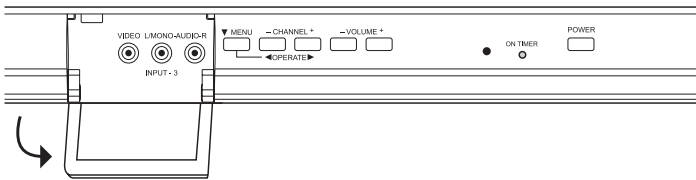

MODEL: AV-27D104

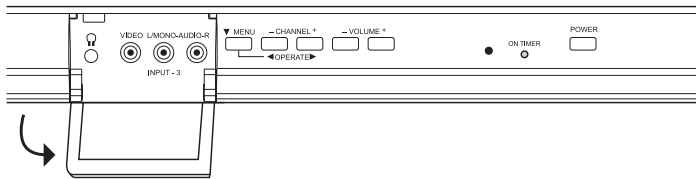

MODEL: AV-20D304

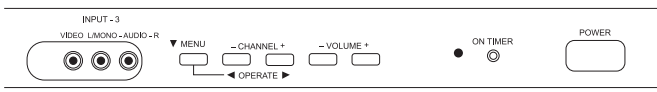

MODELS: AV-27430 and AV-27432

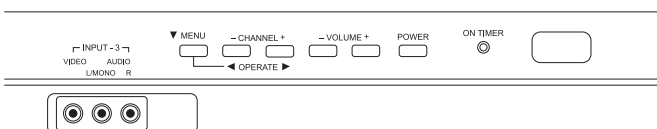

MODELS: AV-32430 and AV-32432

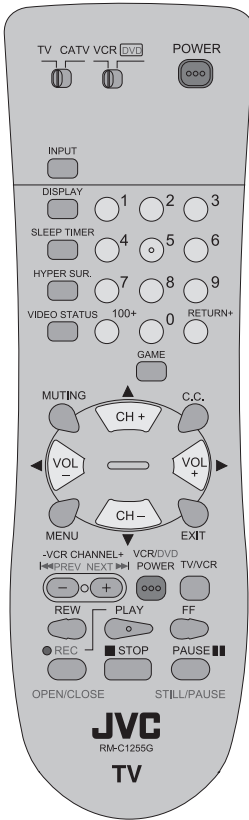

RM-C1255G

**MODEL:
AV-27D104**

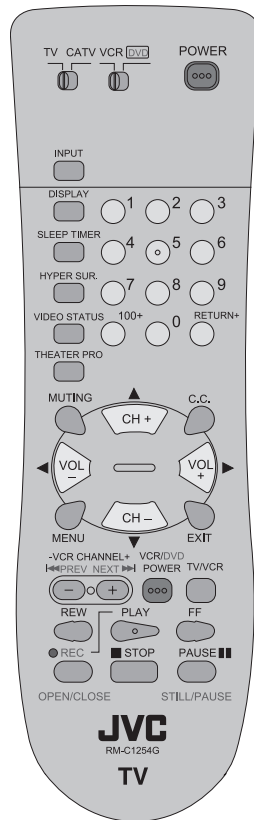

RM-C1254G

**MODEL:
AV-20D304**

- For information on remote control buttons, see pages 41 - 46.

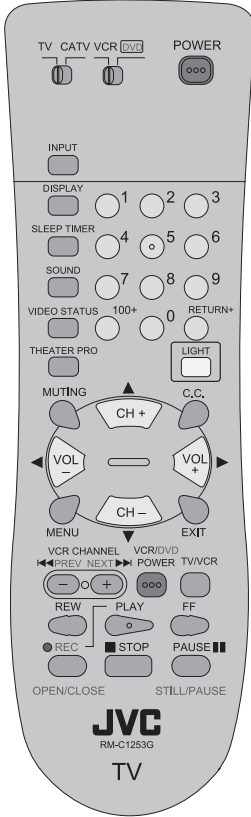

RM-C1253G

MODEL:
AV-27D304

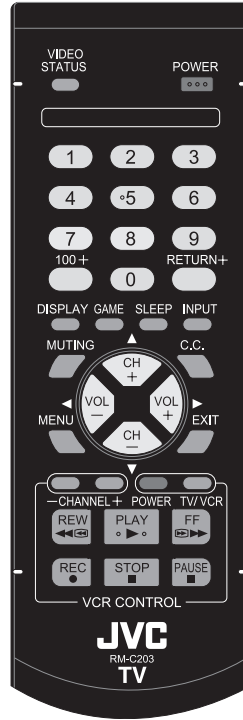

RM-C203

MODELS:
AV-32430
AV-32432
AV-27430
AV-27432

- For information on remote control buttons, see pages 41 - 46.

Getting Started

These quick setup pages will provide you, in three easy steps, with the basic information you need to begin using your new television right away.

If you have questions, or for more detailed information on any of these steps, please consult other sections of this manual.

Step 1 – The Remote Control

Before you can operate your remote control, you first need to install the batteries (included).

For Remote Control RM-C1255G, RM-C1254G and RM-C1253G: Lift and pull the latch on the back of the remote control to open. Insert two batteries (included) carefully noting the “+” and “-” markings, placing the “-” end in the unit first. Snap the cover back into place.

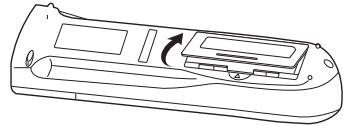

When you change the batteries, try to complete the task within three minutes. If you take longer than three minutes, the remote control codes for your VCR, DVD, and/or cable box/satellite receiver may have to be reset. See pages 20 - 23.

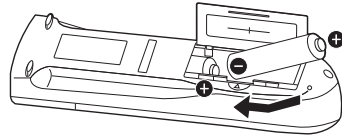

For Remote Control RM-C203: With your thumb, push the latch on the back of the remote control inward, and while holding it there, pull the battery cover out with your index finger. Insert the battery (included) carefully noting the “+” and “-” markings. Push the cover back into place.

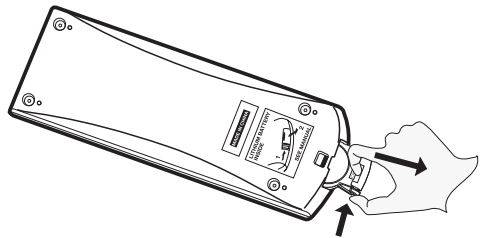

Key Feature Buttons

The four key feature buttons at the center of the remote can be used for basic operation of the television. The top and bottom buttons will scan forward and back through the available channels. To move rapidly through the channels using JVC's **Hyperscan** feature, press and hold CH+ or CH-. The channels will zip by at a rate of five channels per second. The right and left buttons will turn the volume up or down. These buttons are also marked with four arrows and are used with JVC's onscreen menu system. To use the onscreen menus, press the MENU button.

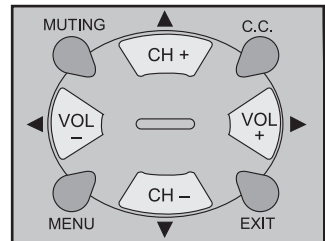

Note: Illustration of remote control RM-C1253G

Basic Operation

Turn the television on and off by pressing the **POWER** button at the top right corner of the remote. If this is the first time you are turning on the TV, the interactive plug-in menu appears.

- Make sure the TV/CATV switch is set to TV. Move the switch to CATV only if you need to operate a cable box. (Except RM-C203)
- Slide the VCR/DVD selector switch to VCR to control a VCR. Slide to DVD to control a DVD player. Please see pages 20 to 23 for instructions on programming your remote control to operate a cable box, VCR or DVD player. (Except RM-C203)

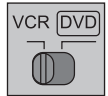
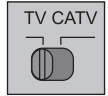
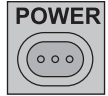

Step 2 – Connecting Your Devices

Please follow the flow chart below to determine which connection setup is right for you. Then, refer to the appropriate diagrams to connect your television to other devices that you may have. After you are finished connecting your devices, plug the power cord into the nearest power outlet and turn on the TV.

A VCR is not necessary for operation of the television. If you follow these diagrams and the television does not work properly, contact your local cable operator.

- To connect a DVD player, see **Diagram #3**. A DVD player is optional.
- If you have a satellite television system, please refer to the satellite TV manual.

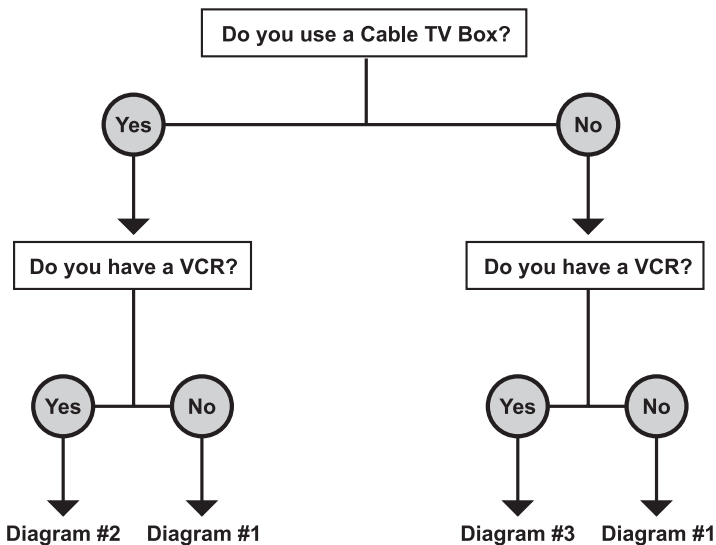
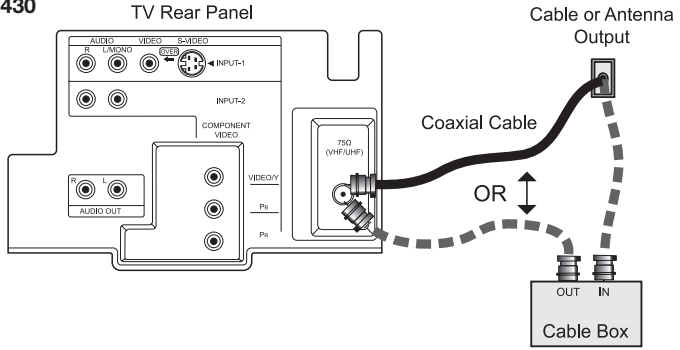

Diagram #1

Illustration of AV-32430



Note:

- If you do not have a cable box, connect the cable wire from the wall outlet into the back of the TV.

Diagram #2

Illustration of AV-32430

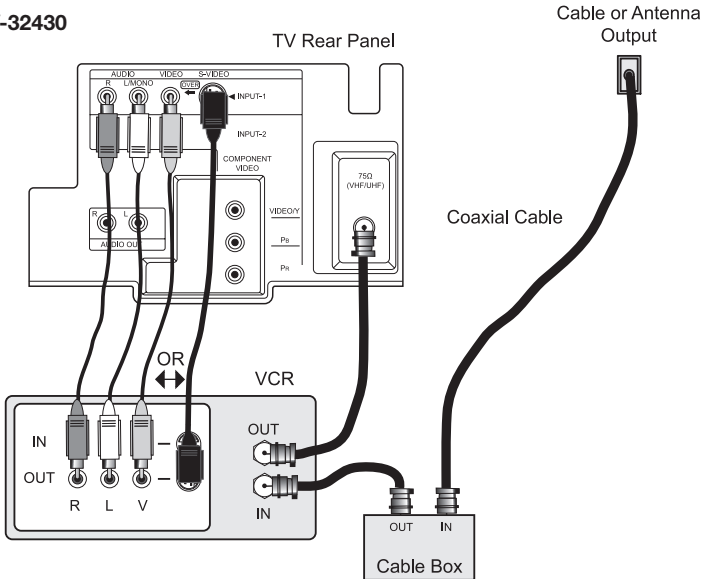

Notes:

- If your VCR is a mono sound unit, it will have only one audio out jack. Connect it to the TV's LEFT AUDIO INPUT.
- Use the S-Video connection if possible for superior picture quality.
- Your VCR must be turned on to view premium cable channels.

Notes:

- Green, blue and red are the most common colors for DVD cables. Some models may vary colors. Please consult the user's manual for your DVD player for more information.
- Be careful not to confuse the red DVD cable with the red audio cable. It is best to complete one set of connections (DVD or audio output) before starting the other to avoid accidentally switching the cables.
- Progressive DVD players (players with an output scan of 31.5 KHz) will not work properly with this television. Set your DVD player's output to "interlaced", or non-progressive mode.

Diagram #3

Illustration of AV-32430

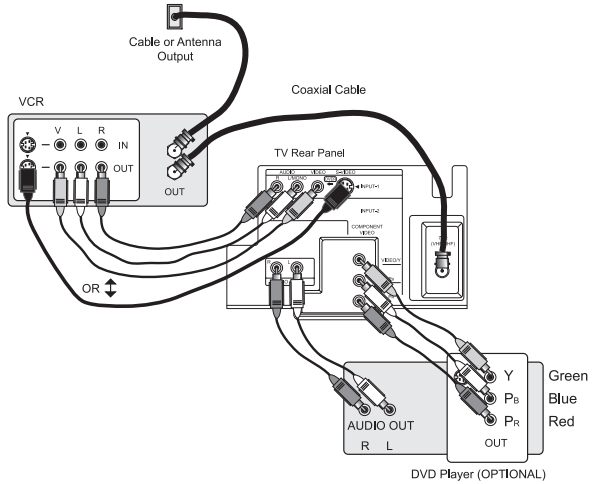

Connecting to an External Amplifier

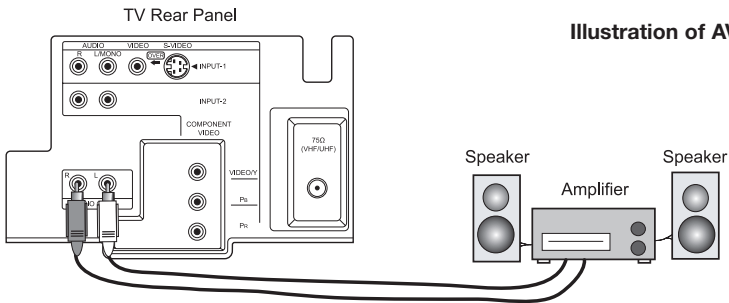

Illustration of AV-32430

- 1) Connect a white composite cable from the LEFT AUDIO OUTPUT on the back of the TV to the LEFT AUDIO INPUT on the amplifier.
- 2) Connect a red composite cable from the RIGHT AUDIO OUTPUT on the back of the TV to the RIGHT AUDIO INPUT on the amplifier.

Notes:

- Refer to your amplifier's manual for more information.
- You can use AUDIO OUTPUT for your home theater system.

Connecting to a Camcorder

You may connect a camcorder, game console or other equipment to your television by using the front input jacks. You can also connect these using the television's rear input jacks, using the same instructions.

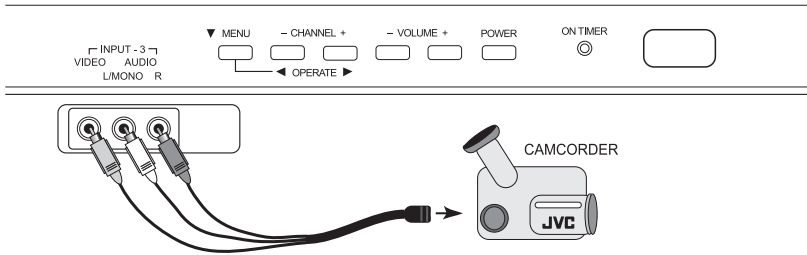

Illustration of AV-32430

- 1) Connect a yellow composite cable from the camcorder VIDEO OUT, into the VIDEO IN on the front of the TV.
- 2) Connect a white composite cable from the camcorder LEFT AUDIO OUT, into the LEFT AUDIO IN on the front of the TV.
- 3) Connect a red composite cable from the camcorder RIGHT AUDIO OUT, into the RIGHT AUDIO IN on the front of the TV.

Note:

- If your camcorder is a mono sound model it will have only one AUDIO OUT. Connect it to the LEFT AUDIO IN.
- AV-27D304, AV-27D104 and AV-20D304: These front input jacks are located under the front panel door. To access, pull on the door to open it.

Headphone Connection

AV-20D304 ONLY.

You can connect a pair of headphones to the television using the headphone jack located under the front panel door. To access, pull on the door to open it.

- 1) Plug a headphone jack into the headphone jack on the television's front panel.

Step 3 – The Interactive Plug In Menu

The interactive plug-in menu appears only for AV-20D304 and AV-27D304. If you television is one of the other models, we recommend you to complete the auto tuner setup to begin watching your TV right away. See page 26.

When you turn your television on for the first time the interactive plug-in menu will appear. The plug-in menu helps you to get your TV ready to use by letting you set your preferences for:

- The language in which you want the onscreen menus to appear.
- Setting the TV's clock to the correct time so your timer functions will work properly. You can choose "AUTO" or "MANUAL" for setting the clock.
- The auto tuner setup of which channels you wish to receive.

We recommend you complete the interactive plug-in items before you start using your television.

Language

After the "JVC INTERACTIVE PLUG IN MENU" has been displayed, the TV automatically switches to the LANGUAGE settings. You can choose to view your onscreen menus in three languages: English, French (Français) or Spanish (Español).

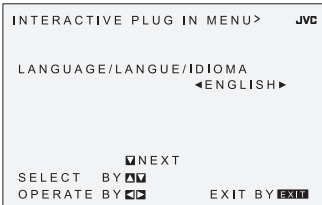

To choose a language:
(English, Français or Español)



To NEXT (To set clock)

(To be continued...)

Auto Clock Set

Before you use any of your TV's timer functions, you must first set the clock. You may precisely set your clock using the XDS time signal broadcast by most public broadcasting stations. If you do not have this in your area, you will have to set the clock manually. See manual clock set below. To set the clock using the XDS signal:

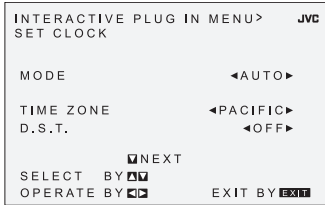

- ◀▶ To choose AUTO
- ▼ To TIME ZONE
- ◀▶ To select your time zone: (Atlantic, Eastern, Central, Mountain, Pacific, Alaska or Hawaii)
- ▼ To move to D.S.T. (Daylight Savings Time)
- ◀▶ To turn D.S.T. ON or OFF
- ▼ To NEXT (To Auto Tuner Setup)

Notes:

- The Daylight Savings Time feature automatically adjusts your TV's clock for Daylight Savings. The clock will move forward one hour at 2:00 am on the first Sunday in April. The clock will move back one hour at 2:00 am on the last Sunday in October.
- You will have to reset the clock after a power interruption. You must set the clock before operating any timer functions.

Manual Clock Set

To set your clock manually (without using the XDS signal), choose MANUAL. If you choose AUTO, see auto clock set above.

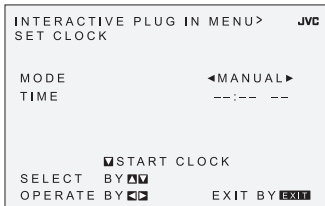

- ◀▶ To choose MANUAL
- ▼ To TIME
- ◀▶ To set the hour
- ▼ To minute
- ◀▶ To set the minute
- ▼ To START CLOCK

Note:

- You will have to reset the clock after a power interruption. You must set the clock before operating any timer functions.

(To be continued...)

Auto Tuner Setup

In auto tuner setup, the TV automatically scans through all available channels, memorizing the active ones and skipping over blank ones or channels with weak signals. This means when you scan (using the CHANNEL +/- buttons) you will receive only clear, active channels.

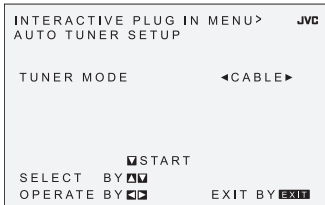

To choose CABLE or AIR (or SKIP when you skip Auto Tuner Setup)



To START



**Programming will take
approximately 1 to 2
minutes.**

When the setup is finished, THANK YOU!! SETUP IS NOW COMPLETE is displayed. Your quick setup is now complete. You can now begin watching your television, or you can continue on in this guide for more information on programming your remote control, or using the JVC onscreen menu system to customize your television viewing experience.

Notes:

- Noise muting will not work during Auto Tuner Setup.
- Skip appears only for interactive plug-in menu.
- The interactive plug-in menu setting does not appear if your TV has been turned on before. In this case, use the initial setup menu to perform these settings. See pages 34, 39 and 26.

Cable Box and Satellite Users: After your auto tuner setup is complete, you may, (depending on the type of hookup), have only 1 channel, usually 3 or 4 in the auto tuner memory. This is normal.



The Quick Setup is complete

Remote Programming

Setting the CATV, VCR and DVD Codes

You can program your remote to operate your cable box, satellite receiver, VCR or DVD player by using the instructions and codes listed below. If the equipment does not respond to any of the codes listed below or to the code search function, use the remote control supplied by the manufacturer.

Note: The RM-C203 remote can only operate JVC-brand devices.

Cable Box or Satellite Codes

The remote control is programmed with cable box and satellite codes for power on/off, channel up/down, and 10 key operation.

- 1) Find the cable box or satellite brand from the list of codes shown below.
 - 2) Slide the 2-way selector switch to "CATV".
 - 3) Press and hold down the DISPLAY button, then enter the first code number listed with the 10 key pad.
 - 4) Release the DISPLAY button, and confirm the operation of the cable box/satellite receiver.
- If your cable or satellite box does not respond to the first code, try the others listed. If it does not respond to any code, try the search codes function, on page 23.

| Cable Box | CODES | Cable Box | CODES | Digital Satellite Systems | CODES | | |
|--------------------|--|------------------------|-----------------------------------|---------------------------|--------------------|--------------|---------------|
| ABC | 024 | Puser | 032 | Echostar | 100, 113, 114, 115 | | |
| Archer | 032, 025 | RCA | 061, 070 | | | | |
| Cableview | 051, 032 | Realistic | 032 | | | | |
| Citizen | 022, 051 | Regal | 058, 064, 040, 041, 042, 045, 068 | | | Express VU | 100, 113 |
| Curtis | 058, 059 | | | | | G.E. | 106 |
| Diamond | 024, 032, 025 | Regency | 034 | | | G.I. | 108 |
| Eagle | 029 | | | | | Gradiente | 112 |
| Eastern | 034 | Rembrandt | 037, 032, 051, 038 | | | Hitachi | 104, 111 |
| GC Brand | 032, 051 | Samsung | 051 | | | HNS (Hughes) | 104 |
| Gemini | 022, 043 | Scientific Atlanta | 057, 058, 059 | | | Panasonic | 105 |
| General Instrument | 065, 024, 025, 026, 027, 020, 021, 022, 057, 023 | SLMark | 051, 047 | | | Philips | 102, 103 |
| | | Sprucer | 051, 056 | | | Primestar | 108 |
| Hamlin | 040, 041, 042, 045, 058, 064 | Stargate | 032, 051 | | | Proscan | 106, 109, 110 |
| Hitachi | 049, 024 | Telecaption | 067 | | | RCA | 106, 109, 110 |
| | | Televue | 047, 051 | | | Sony | 107 |
| Jerrold | 065, 024, 025, 026, 027, 020, 021, 022, 057, 023 | Texscan | 044 | | | Star Choice | 104, 108 |
| | | Tocom | 035, 036, 066 | | | Toshiba | 101 |
| | | Toshiba | 050 | | | Uniden | 102, 103 |
| Macom | 049, 050, 051, 054 | Unika | 032, 025 | | | | |
| Magnavox | 033 | Universal | 022, 032 | | | | |
| | | Videoway | 052 | | | | |
| Memorex | 030 | Viewstar | 029, 030 | | | | |
| Movietime | 032, 051 | Zenith | 063, 046 | | | | |
| Oak | 039, 037, 048 | Zenith/Drake Satellite | 046 | | | | |
| Panasonic | 055, 056, 060, 071, 073 | | | | | | |
| Paragon | 063 | | | | | | |
| Philips | 028, 029, 030, 052, 053, 031, 069 | | | | | | |
| Pioneer | 047, 062 | | | | | | |
| Pulsar | 051, 032 | | | | | | |

Remote Programming

VCR Codes

The remote control is programmed with VCR codes for power on/off, play, stop, fast-forward, rewind, pause, record, channel up/down operation.

- 1) Find the VCR brand from the list of codes shown below.
 - 2) Slide the first 2-way selector switch to "TV" and the other 2-way selector switch to "VCR".
 - 3) Press and hold down the DISPLAY button, then enter the first code number listed with the 10 key pad.
 - 4) Release the DISPLAY button, and confirm the operation of the VCR.
- If your VCR does not respond to the first code, try the others listed. If it does not respond to any of the codes, try the search codes function on page 23.
 - After you program your remote, some VCR buttons may not work properly. If so, use the VCR's remote.
 - To record, hold down the REC button on the remote and press PLAY.

| VCRs | CODES | VCRs | CODES | VCRs | CODES |
|----------------|--|-------------|--|-----------------|--|
| Admiral | 035 | Marantz | 003, 004, 005 | Samsung | 037, 060, 062, 033, 089 |
| Aiwa | 027, 032, 095 | Marta | 064 | Samtron | 089 |
| Akai | 029, 072, 073, 074 | Memorex | 024, 067 | Sansui | 003, 026, 020, 052 |
| Audio Dynamic | 003, 005 | MGA | 038, 040, 047, 048, 041, 042 | Sanyo | 063, 067, 091, 071 |
| Bell & Howell | 063, 071 | Minolta | 058, 045, 093 | Scott | 059, 060, 062, 067, 038, 040, 047, 048, 026, 020 |
| Broksonic | 020, 026, 094 | Mitsubishi | 038, 040, 047, 048, 041, 042, 078, 090 | Sears | 063, 064, 065, 066, 058, 000, 001 |
| Canon | 023, 025 | Multitech | 047, 027, 062 | Shintom | 075 |
| CCE | 043 | NEC | 003, 004, 005, 000 | Sharp | 035, 036, 080, 088 |
| Citizen | 064 | Olympic | 024, 023 | Signature 2000 | 027, 035 |
| Craig | 063, 029, 064 | Optimus | 028, 021, 035, 064 | Singer | 075 |
| Curtis Mathes | 045, 024, 027, 093 | Orion | 026, 020 | Sony | 028, 029, 030, 053, 054, 055 |
| Daewoo | 043, 059, 024, 092 | Panasonic | 023, 024, 021, 022 | SV 2000 | 027 |
| DBX | 003, 004, 005 | Penney | 024, 058, 045, 063, 003, 004, 005, 093 | Sylvania | 031, 023, 024, 027 |
| Dimensia | 045, 093 | Pentax | 058, 005, 045, 093 | Symphonic | 027, 081 |
| Emerson | 043, 026, 077, 061, 025, 042, 020, 076 | Philco | 031, 024, 027, 023, 026, 020, 043 | Tashiro | 064 |
| Fisher | 063, 066, 067, 065, 071, 091 | Philips | 031, 023, 024, 086 | Tatung | 003, 004, 005 |
| Funai | 027, 026, 020, 000 | Pioneer | 023 | Teac | 003, 004, 027, 005 |
| G.E. | 033, 045, 024 | Proscan | 045, 058, 023, 024, 031, 046, 059, 060, 033, 087, 093 | Technics | 021, 022, 023, 024 |
| Go Video | 037, 051, 049, 050, 089 | Quasar | 021, 022, 023, 024 | Teknika | 024, 027, 070 |
| Goldstar | 064 | Radio Shack | 033, 024, 063, 036, 067, 040, 027 | Toshiba | 059, 046, 079 |
| Gradiente | 083, 084, 081, 000, 001 | RCA | 033, 045, 058, 023, 024, 031, 046, 059, 060, 083, 084, 085, 087, 093 | Vector Research | 005 |
| Hitachi | 023, 045, 058, 027, 081, 093 | Realistic | 024, 063, 036, 067, 040, 027 | Wards | 035, 036, 067, 044, 064 |
| Instant Replay | 024, 023 | | | Yamaha | 063, 003, 004, 005 |
| Jensen | 003 | | | Zenith | 044, 082, 064, 094 |
| JVC | 000, 001, 002, 003, 004, 005 | | | | |
| Kenwood | 003, 004, 064, 005 | | | | |
| LXI | 027, 064, 058, 065, 066, 063, 067 | | | | |
| Magnavox | 031, 023, 024, 086 | | | | |

Remote Programming

DVD Codes

The remote control is programmed with DVD codes for power on/off, play, stop, fast-forward, rewind, previous/next chapter, tray open/close, and still/pause operation.

- 1) Find the DVD player brand from the list of codes shown below.
 - 2) Slide the first 2-way selector switch to "TV" and the other 2-way selector switch to "DVD".
 - 3) Press and hold down the DISPLAY button, then enter the first code number listed with the 10 key pad.
 - 4) Release the DISPLAY button, and confirm the operation of the DVD player.
- If your DVD player does not respond to the first code, try the others listed. If it does not respond to any of the codes, try the search codes function on page 23.
 - After you program your remote, some DVD buttons may not work properly. If so, use the DVD player's remote.

| DVD Player | CODES | DVD Player | CODES |
|------------|----------|------------|-----------------------|
| Aiwa | 043 | RCA | 021, 026 |
| Apex | 040 | Sampo | 034 |
| Denon | 020, 037 | Samsung | 030 |
| Hitachi | 030, 031 | Sharp | 028 |
| JVC | 000 | Sylvania | 038 |
| Kenwood | 035 | Sony | 024, 045, 046, 047 |
| Konka | 039 | | |
| Mitsubishi | 025 | Technics | 020 |
| Onkyo | 041 | Toshiba | 023 |
| Oritron | 044 | Vialta | 050 |
| Panasonic | 020 | Wave | 042 |
| Philips | 023, 036 | Yamaha | 020 |
| Pioneer | 022 | Zenith | 027, 032 |
| Raite | 033 | | |

Remote Programming

Search Codes

Cable/Satellite Search Codes Function

- 1) Slide the first 2-Way Mode Selector switch to CATV.
- 2) Press the POWER and RETURN+ buttons. Hold for at least three seconds and release.
- 3) Press the POWER button on the remote, and see if the cable or satellite box responds.
- 4) If there was a response, press RETURN+. The codes are now set. If there was no response, repeat Step 3. If you repeat Step 3 a total of 52 times without a response, use the remote control that came with your equipment.
- 5) Press RETURN+ to exit.



VCR/DVD Search Codes Function

- 1) Slide the first 2-way selector switch to "TV" and the other 2-way selector switch to "VCR" or "DVD".
- 2) Press the VCR or DVD POWER and RETURN+ buttons. Hold for at least three seconds and release.
- 3) Press the VCR or DVD POWER button, and see if the VCR or DVD responds.
- 4) If there was a response, press RETURN+. The codes are now set. If there was no response, repeat Step 3. If you repeat Step 3 a total of 80 times for the VCR (30 times for the DVD player), and there is no response, use the remote control that came with your equipment.
- 5) Press RETURN+ to exit.

Onscreen Menus

Using the Guide

Certain symbols are used throughout this guide to help you learn about the features of your new television. The ones you will see most frequently are:

- ▲▼ Up and Down arrows mean press the CH+ or CH- buttons. Pressing the CH+ or CH- buttons let you:
 - Move vertically in a main menu screen
 - Move through a submenu screen
 - Move to the next letter, number, or other choice in a submenu
 - Back up to correct an error
 - Scan through TV channels (when not in a menu screen)
- ◀▶ Left and right arrows mean press the VOLUME+ or VOLUME- buttons to move left or right to:
 - Select a highlighted menu item
 - Select an item in a submenu
 - Select numbers in certain menu options
 - Turn the volume up or down (when not in a menu screen)
-  The “press button” icon means you should press the button named on your remote control. (Button names appear in SMALL CAPITAL LETTERS.)
-  The “helping hand” icon points to the highlighted or selected item in a menu.

To bring up the onscreen menu, press the MENU button on the remote control. The item that appears in yellow is the one currently selected. If you press the MENU button again, the onscreen display will skip to the next menu screen. If you use the Menu button on the TV's front panel instead of the remote, an additional menu screen showing input will appear. The “interactive plug-in menu” will appear the first time the TV is plugged in.

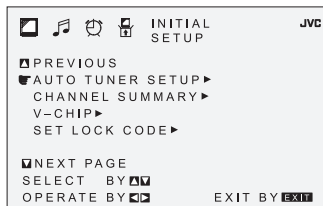

Notes:

- Menus shown in this book are illustrations, not exact replications of the television's onscreen displays.
- If you do not press any buttons for a few seconds, the onscreen menu will automatically shut off.

Onscreen Menus

The Onscreen Menu System

Your television comes with JVC's onscreen menu system. The onscreen menus let you make adjustments to your television's operation simply and quickly. Examples of the Onscreen Menus are shown below. Detailed explanations on using each menu follow later in this guide. For information about the interactive plug-in Menu, see pages 17 - 19.



Press the MENU button

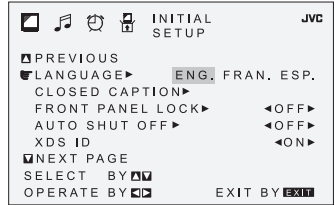
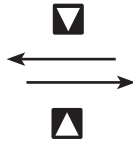
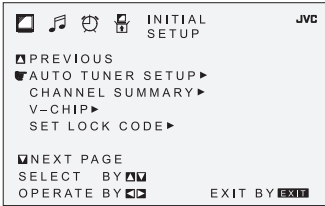

INITIAL SETUP 02

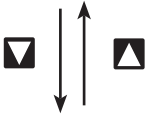

INITIAL SETUP 01

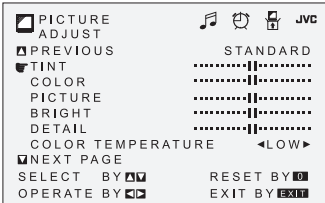
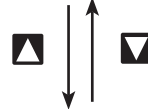

PICTURE ADJUST 01

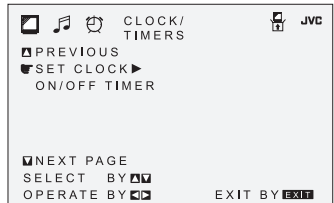
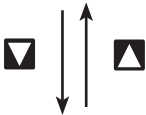

CLOCK/TIMERS

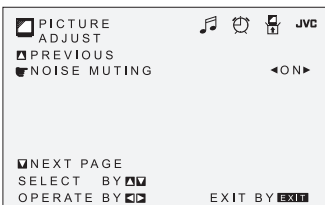
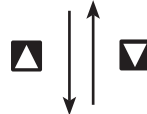

PICTURE ADJUST 02

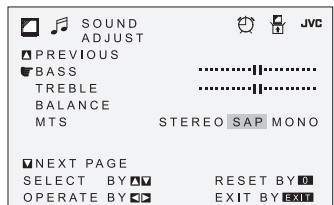
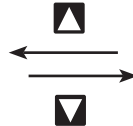

SOUND ADJUST

"XDS ID" AV-27D304 and AV-20D304 only.

"Color Temperature" AV-27D304 and AV-20D304 only.

Initial Setup

Auto Tuner Setup

The auto tuner setup function is described on page 19 as the interactive plug-in menu. If you need to run the auto tuner setup again, follow the steps below.



Press the MENU button



To AUTO TUNER SETUP



To operate



To choose CABLE or AIR



To move to START



To start Auto Tuner Setup

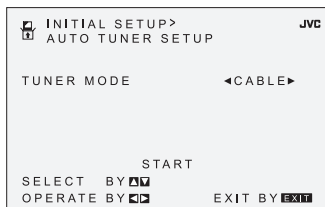

Programming will take approximately 1 to 2 minutes. The auto tuner is finished when the message **PROGRAMMING OVER!** appears onscreen.

Channel Summary

Channel summary allows you to customize the line-up of channels received by your TV. You can add or delete channels from the line-up or prevent any unauthorized viewers from watching any or all 181 channels.



Press the MENU button



To CHANNEL SUMMARY



To operate

The Channel summary screen will now be displayed with the channels set to scan marked with an “✓”. You can delete channels from the scan by removing the “✓”. If any channels were missed during auto tuner setup and you wish to add them, you may be placing an “✓” next to the channel number.



To the SCAN column



To include or delete from scan



Press the EXIT button when finished

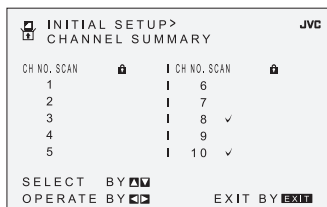

You can block access to a channel by activating the channel lock.



Press the MENU button



To CHANNEL SUMMARY



To operate



To the Lock Column (🔒)



Press the ZERO button to lock or unlock that channel



Press the EXIT button when finished

Initial Setup

Channel Guard Message

When a viewer attempts to watch a guarded channel, the following message appears:

To watch a channel that you have locked, enter the Lock Code using the 10 key pad.
If the wrong code is entered, the message "INVALID LOCK CODE!" will flash on the screen.

The channel cannot be accessed until the correct code is entered.

THIS CHANNEL IS LOCKED BY
CHANNEL GUARD.
PLEASE ENTER LOCK CODE BY
10 KEY PAD TO UNLOCK IT.
NO. - - - -

Notes:

- Once a channel has been unlocked, it will remain unlocked until the television is turned off.
- See also "Set Lock Code", page 33.

V-Chip

Your TV is equipped with V-Chip technology which enables you to block channels or content that you feel to be inappropriate for children, based on US and Canada rating guidelines. V-Chip has no effect on video signals from a DVD discs, VCR tapes or Camcorder connection.

Note: Some programs, and movies are broadcast without a ratings signal. Even if you set up V-CHIP ratings limits, these programs will not be blocked. See page 28 for information on how to block unrated programs.

Note (for Canadian viewers): The V-Chip function is based on specifications designed for the United States and therefore may not work properly in Canada.

You can customize the V-Chip settings of your television to match your personal tastes. The V-Chip menu below is the starting point for your V-Chip settings

You can use US V-Chip settings (for programming broadcast from the United States), Canadian V-Chip settings (for programming broadcast from Canada), and movie ratings. You may use any or all of the settings (US V-Chip, Canada V-Chip, Movie ratings). Descriptions for setting each of the three V-Chip formats appear in the next six pages along with descriptions of the rating categories.

To access the rating categories:



Press the MENU button



To V-CHIP



To operate (Lock icon  will appear)



Press ZERO to access the V-Chip menu



To turn V-Chip ON or OFF (V-Chip must be turned ON for rating settings to operate)



To move to SET US TV RATINGS, SET MOVIE RATINGS, or SET CANADIAN RATINGS (see following pages for descriptions of each item)



Initial Setup

Unrated Programs

Unrated programming refers to any programming which does not contain a rating signal. Programming on television stations which do not broadcast rating signals will be placed in the "Unrated Programming" category.

Examples of Unrated programs:

- Emergency Bulletins
- News
- Public Service Announcements
- Sports
- Some Commercials
- Locally Originated Programming
- Political Programs
- Religious Programs
- Weather

Note:

- TV programs or movies that do not have rating signals will be blocked if the unrated category is set to BLOCK.

Directions to Block Unrated Programs

You can block programs that are not rated.



Press the MENU button



To V-CHIP



To operate (The lock icon  appears)



Press ZERO to access V-Chip setup options



To UNRATED



To VIEW or BLOCK



Press EXIT when done



US V-Chip Ratings

U.S. PARENTAL RATING SYSTEMS

Programs with the following ratings are appropriate for children.

TV Y is Appropriate for All Children

Programs are created for very young viewers and should be suitable for all ages, including children ages 2 - 6.

TV Y7 is for Older Children

Most parents would find such programs suitable for children 7 and above. These programs may contain some mild fantasy violence or comedic violence, which children should be able to discern from reality.

Programs with the following ratings are designed for the entire audience.

TV G stands for General Audience

Most parents would find these programs suitable for all age groups. They contain little or no violence, no strong language, and little or no sexual dialog or situations.

TV PG Parental Guidance Suggested

May contain some, but not much, strong language, limited violence, and some suggestive sexual dialog or situations. It is recommended that parents watch these programs first, or with their children.

TV 14 Parents Strongly Cautioned

Programs contain some material that may be unsuitable for children under the age of 14 including possible intense violence, sexual situations, strong coarse language, or intensely suggestive dialog. Parents are cautioned against unattended viewing by children under 14.

TV MA Mature Audiences Only

These programs are specifically for adults and may be unsuitable for anyone under 17 years of age. TV MA programs may have extensive V, S, L, or D.

Viewing Guidelines

In addition to the ratings categories explained above, information on specific kinds of content are also supplied with the V-Chip rating. These types of content may also be blocked. The content types are:

- **V/FV** is for VIOLENCE/FANTASY VIOLENCE
- **S** stands for SEXUAL CONTENT
- **L** stands for strong LANGUAGE
- **D** stands for suggestive DIALOG

Initial Setup

Setting US V-Chip Ratings



Press the MENU button



To V-CHIP



To operate (lock icon  appears)



Press ZERO to access the V-Chip menu



To turn V-Chip ON or OFF



To move to SET US TV RATINGS



To operate



Directions to set US V-Chip Ratings

Line up the cursor in the column (TV PG, TV G, etc.) with the content row (V/FV, S, etc.) and press the ▲ or ▼ to move the cursor to the correct location. Press ◀ or ▶ to turn the locking feature on or off. An item is locked if the  icon appears instead of a “—”.

For example. To block viewing of all TV 14 shows, move the cursor to the top row of that column and add a lock icon. Once you've put a lock on the top row, everything in that column is automatically locked.



To the TV 14 Column



To turn on the lock



To FINISH



To save settings and exit



Press the EXIT button when finished

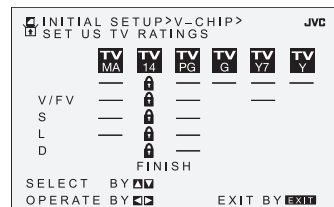

Note:

- If you want to change the setup, move the cursor to the top column and change the lock icon to “—” by pressing ◀ or ▶ again. You may then select individual categories to block.

Movies Ratings

NR – Not Rated

This is a film which has no rating. In many cases these films were imported from countries which do not use the MPAA ratings system. Other NR films may be from amateur producers who didn't intend to have their film widely released.

NR (Not Rated) Programming may contain all types of programming including children's programming, foreign programs, or adult material.

G – General Audience

In the opinion of the review board, these films contain nothing in the way of sexual content, violence, or language that would be unsuitable for audiences of any age.

PG – Parental Guidance

Parental Guidance means the movie may contain some contents such as mild violence, some brief nudity, and strong language. The contents are not deemed intense.

PG-13 – Parents Strongly Cautioned

Parents with children under 13 are cautioned that the content of movies with this rating may include more explicit sexual, language, and violence content than movies rated PG.

R – Restricted

These films contain material that is explicit in nature and is not recommended for unsupervised children under the age of 17.

NC-17 – No One Under 17

These movies contain content which most parents would feel is too adult for their children to view. Content can consist of strong language, nudity, violence, and suggestive or explicit subject matter.

X – No One under 18

Inappropriate material for anyone under 18.

Directions to set Movie (MPAA) Ratings



Press the MENU button



To V-CHIP



To operate (Lock icon  appears)



Press ZERO to access V-Chip setup options



To SET MOVIE RATINGS



To enter movies menu

For example:

To block viewing of X and NC-17 rated from shows:



To the X Column



To turn on the lock



To the NC-17 Column



To turn on the lock



To FINISH



To save settings and exit



Press the EXIT button when finished

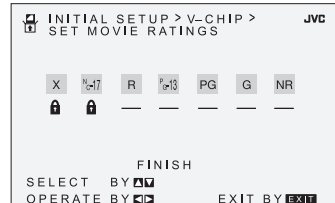

Initial Setup

Canadian V-Chip Ratings

- ❑ **E – Exempt**
Exempt programming includes: news, sports, documentaries and other information programming, talk shows, music videos, and variety programming.
- ❑ **C – Programming Intended for Children**
Violence Guidelines: There will be no realistic scenes of violence. Depictions of aggressive behavior will be infrequent and limited to portrayals that are clearly imaginary, comedic or unrealistic in nature.
- ❑ **C8+ – Programming Intended for Children 8 and Over**
Violence Guidelines: Any realistic depictions of violence will be infrequent, discreet, of low intensity and will show the consequences of the acts. There will be no offensive language, nudity or sexual content.
- ❑ **G – General Audience**
Programming will contain little violence and will be sensitive to themes which could affect younger children.
- ❑ **PG – Parental Guidance**
Programming intended for a general audience, but which may not be suitable for younger children. Parents may consider some content not appropriate for children aged 8-13.
- ❑ **14+ – 14 Years and Older**
Parents are strongly cautioned to exercise discretion in permitting viewing by pre-teens and early teens. Programming may contain mature themes and scenes of intense violence.
- ❑ **18+ – Adult**
Material intended for mature audiences only.

Directions to set Canadian V-Chip Ratings



Press the MENU button



To V-CHIP



To operate (lock icon  appears)



Press ZERO to access V-Chip setup options



To SET CANADIAN RATINGS ENG (for English)



To enter ratings menu

For example:

To block viewing of programming rated 14+ and 18+:



To the 18+ Column



To turn on the lock



To the 14+ Column



To turn on the lock



To FINISH



To save settings and exit



Press the EXIT button when finished

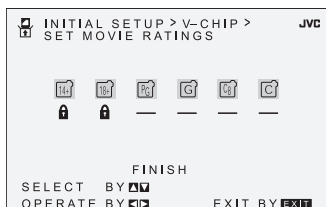

Note:

- For instructions on “SET CANADIAN RATINGS FRE (in French)”, please see page 32 in the French side of this user’s guide.

Initial Setup

Set Lock Code

Channel guard and V-Chip settings are protected by a four-digit lock code. Your TV comes pre-set with a lock code of "0000". You may change the code to any four-digit number you wish. To change the lock code, follow the steps below.



Press the MENU button



To SET LOCK CODE



To operate (lock icon  appears)



Press ZERO to access the lock code

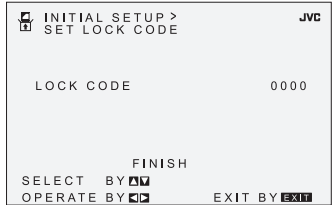

The first digit will be highlighted



To select the number



To move to the next digit

Continue to follow these directions for all four numbers



To FINISH



To save settings and exit
(your lock code is now set)



Press the EXIT button when finished

When a viewer attempts to watch a blocked channel, this message appears:

THIS PROGRAMMING EXCEEDS
YOUR RATING LIMITS.
PLEASE ENTER LOCK CODE BY
10 KEY PAD TO UNLOCK IT.
NO. - - - -

The channel will remain blocked until the correct lock code is entered (see above for information on setting your lock code).

Notes:

- After a power interruption you must reset the lock code.
- Write your lock code number down and keep it hidden from potential viewers.
- If you forget the lock code, a new code may be set using the steps listed above.

Initial Setup

Language

The language function is described on page 17 as the interactive plug-in menu. If you need to choose the language again, follow the steps below.



Press the MENU button



To LANGUAGE



To choose a language: ENG. (English), FRAN. (French) or ESP. (Spanish)



Press the EXIT button when finished

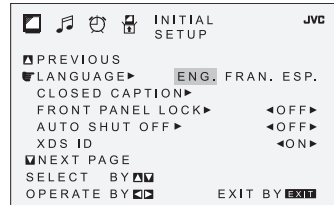

Closed Caption

Many broadcasts now include an onscreen display of dialog called closed captions. Some broadcasts may also include displays of additional information in text form. Your television can access and display this information using the closed caption feature. To activate the closed caption feature, follow the steps below.



Press the MENU button



To CLOSED CAPTION



To operate



To select CAPTION or TEXT



To select a caption (CC1 to CC4) or text channel (T1 to T4)



To accept that selection and move to FINISH



To save settings and exit



Press the EXIT button when finished

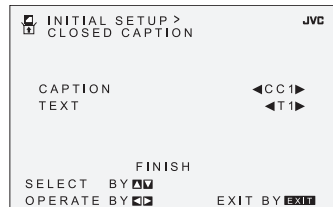

Notes:

- Closed caption subtitles are usually found on closed caption channel CC1. Some programs may include additional text information which is usually found on text channel T1. The other channels are available for future use.
- Closed captioning may not work correctly if the signal being received is weak or if you are playing a video tape.
- Most broadcasts containing closed captioning will display a notice at the start of the program.
- To select the mode, press the C.c. button. See page 45.

XDS ID

XDS ID Display provides a channel's call letters, the network's name, and even a program name. The XDS ID information is provided by the broadcaster.



Press the MENU button



To XDS ID



To turn ON or OFF



Press the EXIT button when finished

- For models AV-20D304 and AV-27D304.

Front Panel Lock

This allows you to lock the keys on the front of the TV, so that a child may not accidentally change your viewing preferences.



Press the MENU button



To FRONT PANEL LOCK



To turn ON or OFF



Press the EXIT button when finished

You can turn off this feature in the following ways:

- Unplug the power cord, and plug it back in. Do this if your batteries die, or you lose your remote control.
- Use the remote control.
- Press the MENU button on the front of the TV for more than 3 seconds. In this case, the OSD for FRONT PANEL LOCK will appear.

Note:

- To turn ON/OFF the TV, press the power button for more than 3 seconds. This feature will remain ON.

Auto Shut Off

This function automatically shuts off your TV when there is no signal from the channel the TV is on.



Press the MENU button



To AUTO SHUT OFF



To turn ON or OFF



Press the EXIT button when finished

- If the channel that you have on does not receive a signal for more than one minute, the blinking text “NOT RECEIVING A SIGNAL” appears on the screen, and starts the countdown. If no signal is being received within 10 minutes, the TV shuts itself off.

Picture Adjust

Picture Settings

These settings allow you to change and adjust the way the picture appears on your television.

TINT

Tint allows you to adjust the levels of red and green in your TV picture.

COLOR

The color function lets you make all the colors in the TV picture appear either more vivid or subtle.

PICTURE

Picture allows you to adjust the levels of black and white on the TV screen, giving you a darker or brighter picture overall.

BRIGHT

You can adjust the overall brightness of the TV picture with the Bright control.

DETAIL

The Detail feature adjusts the level of fine detail displayed in the picture.

Adjust the Picture Settings



Press the MENU button



To TINT, COLOR, PICTURE, BRIGHT or
DETAIL



To enter



To adjust the setting



To move to the next setting



Press the EXIT button when finished

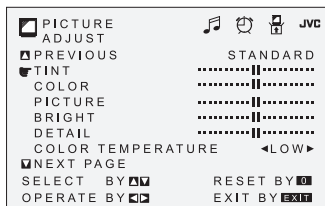

Note:

- If you press the 0 button, you can reset the setting to the factory default setting.

Picture Adjust

Color Temperature

You can decide how strong or dull the colors appear on the TV screen.



Press the MENU button



To COLOR TEMPERATURE



To enter



To set LOW or HIGH



Press the EXIT button when finished

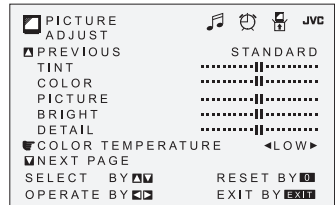

- For models AV-27D304 and AV-20D304 only.

Note: If you press the 0 button, you can reset the color temperature to “LOW”.

Noise Muting

This feature inserts a blank blue screen over channels which are not broadcasting or are too weak to be received clearly.



Press the MENU button



To NOISE MUTING



To turn noise muting ON or OFF



Press the EXIT button when finished

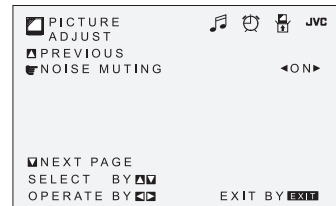

Note:

- Noise muting will not work during auto tuner setup or when you operate channel summary.

Sound Adjust

Sound Settings

These settings allow you to change and adjust the way the picture appears on your television.

BASS – You can increase or decrease the level of low-frequency sound in the TV's audio with the bass adjustment.

TREBLE – Use treble to adjust the level of high-frequency sound in your TV's audio.

BALANCE – Adjust the level of sound between the TV's left and right speakers with the balance setting.

Adjust the Sound Settings



Press the MENU button



To BASS, TREBLE or BALANCE



To adjust the setting



To move to the next setting



Press the EXIT button when finished

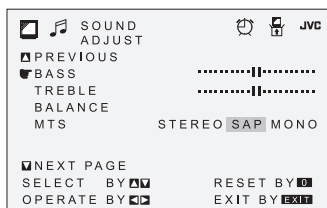

Notes:

- You can reset the sound adjustments (BASS TREBLE and BALANCE) you set at once as the default setting when you select reset.
- If you press the 0 button, you can reset the setting to the factory default setting.

MTS (Multi-Channel Television Sound)

MTS technology allows several audio signals to be broadcast at once, giving you a choice in what you wish to hear with a TV program. In addition to mono or stereo sound, an MTS broadcast may also include a second audio program (SAP).



Press the MENU button



To MTS



Select the mode

(The ON AIR arrow tells you if a broadcast is in stereo and/or contains an SAP).



Press the EXIT button when finished

Notes:

- Keep the TV in stereo mode to get the best sound quality. The sound will work in stereo mode even if a certain broadcast is in mono sound only.
- Choose the mono setting to reduce excessive noise on a certain channel or broadcast.
- Selecting SAP will allow you to hear an alternative soundtrack, if one is available.
- MTS is unavailable if your television's input source is in input 1, 2, or 3 mode, as described on page 45.

Set Clock

The set clock function is described on page 18 as the interactive plug-in menu. You can choose to set the clock automatically, or manually. If you need to set the clock again, follow the steps below.



Press the MENU button



To SET CLOCK



To operate

When you set the clock automatically, choose **AUTO** by pressing the ◀ or ▶ arrows.



To TIME ZONE



To select your time zone



To D.S.T. (daylight savings time)



To turn D.S.T. ON or OFF



To FINISH



To save settings



Press the EXIT button when finished

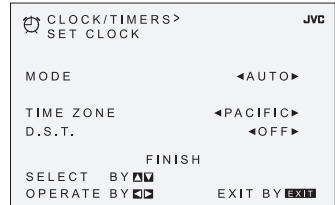

When you set the clock manually, choose **MANUAL** by pressing the ◀ or ▶ arrows.



To move to the hour



To set the hour



To move to minutes



To set the minutes



To START CLOCK



To operate

THANK YOU!!

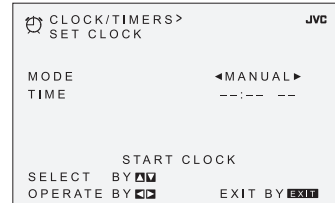

Clock/Timers

On/Off Timer

The on/off timer lets you program your television to turn itself on or off. You can use it as an alarm to wake up, to help you remember important programs, or as a decoy when you're not home.



Press the MENU button



To ON/OFF TIMER



To operate (begins with ON TIME)



To set the hour (AM/PM) you want the TV to turn on



To move to minutes



To set the minutes



To accept ON TIME and move to OFF TIME (the time the TV will turn off). Set the OFF TIME the same way as ON TIME



To accept OFF TIME and move to CHANNEL



To select channel



To ON VOLUME



To set the volume level



To move to MODE



Choose ONCE or EVERYDAY



To ON/OFF TIMER



Choose YES to accept the timer setting, choose NO if you don't wish to accept



To FINISH



To save settings



Press the EXIT button when finished

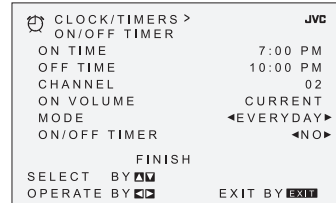

Notes:

- The on/off time cannot be set to locked or guarded channels.
- In order for the on/off timer to work, the clock must be set.
- After a power interruption, the timer settings must be reset.

Button Functions

Power

Turns the TV on or off.



Press the POWER button

Number Buttons - 10Key Pad

Use the number buttons on the remote control to move directly to a specific channel. For example, to move to channel 7:



0 (Zero)



7 (Seven)

Channel +/-

Use these buttons to move up or down all the available channels your TV is able to receive.

Volume +/-

Use these buttons to raise or lower the TV's volume level.

100+ Button

Use the 100+ button to directly access channels above channel 99. For example, to move to channel 124, press 100+, 2 (Two), 4 (Four).

Menu

The MENU button allows you to access JVC's onscreen menu system. Press MENU to activate the onscreen menu system.

- See individual topics like "Sound Adjust" for specific information on using menus.

Exit

Use this button to enter or exit the TV's onscreen menus.

Button Functions

Return +

The RETURN+ button has two functions:

Return - Returns to the channel viewed just before the channel currently onscreen.

Return+ - Lets you program a specific channel to return to while scanning through the channels using the CH+ and CH- buttons.



RETURN+ and hold for three seconds

RETURN CHANNEL
PROGRAMMED !

The channel currently active has been programmed as your return+ channel. Now scan through the channels using the CHANNEL+/- buttons.



RETURN+

You will return to your programmed channel.

- To cancel your Return+ channel, press and hold the RETURN+ button for three seconds. The message "RETURN CHANNEL CANCELLED!" will appear.
- Return+ works only with the CH+/- buttons. Pressing any number key will cancel Return+.

Sleep Timer

The Sleep Timer can turn the TV off for you after you fall asleep. Program it to work in intervals of 15 minutes, for a total time of up to 180 minutes.



Press the SLEEP TIMER button

→ 0 15 30 45 60 75 90 105 120 135 150 165 180 →

Sleep Timer Message

20 seconds before the automatic shutoff, this message will appear:

GOOD NIGHT!!
PUSH SLEEP TIMER BUTTON
TO EXTEND.

You then have 20 seconds to press the sleep timer button to delay the shut off for another 15 minutes.

Muting

The MUTING button instantly turns the volume down completely when you press it. Press MUTING and the volume level will instantly go to zero. To restore the volume to its previous level, press MUTING again.

Button Functions

Display

The display screen shows the current status of timers, inputs, and XDS ID.



Press the DISPLAY button

The screen to the right shows the following information:

- The current channel or AV input (Channel 05)
- The current time (12:20 pm)
- Sleep timer status/minutes remaining (The Sleep Timer is off)
- On/off timer status (Set to turn on everyday at 7:00 PM, off at 10:00 PM)
- Each Press of the DISPLAY button changes the display mode:

| | |
|---------------|----------|
| 05 KLVX PBS | |
| SESAME STREET | |
| NOW | 12:20 PM |
| SLEEP TIMER | OFF |
| ON/OFF TIMER | EVERYDAY |
| ON TIME | 7:00 PM |
| OFF TIME | 10:00 PM |

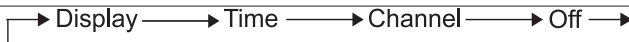

Display - Full screen shown above

Time - Shows the current time only

Channel - Shows the current channel

Off - Turns display off

Notes:

- You may also turn off the display at any step by pressing MENU.
- If the clock, sleep timer or on/off timer are not set, the display screen will show: "CLOCK NOT SET", "SLEEP TIMER OFF", and "ON/OFF TIMER OFF" respectively.

Video Status

The VIDEO STATUS button gives you a choice of four TV picture display settings, including a display of your own preferences.

STANDARD - Resets the picture display to the factory settings.

DYNAMIC - Heightens contrast.

THEATER - Gives a rich, film-like look to video when viewing in a dimly lit room.

(AV-27D304, AV-20D304 and AV-27D104 only)

SPORTS - When you watch a sports program.

(AV-27430, AV-27432, AV-32430 and AV-32432 only)

GAME - Used for when you are playing video games connected to your TV.



Press the VIDEO STATUS button

By every press of the video status button, you change the mode.



Button Functions

Sound

RM-C1253G only

The SOUND button give you a choice of two sound effects.

Hyper Surround - Creates a deep, three-dimensional sound effect by channeling the audio through the TV's front-firing speakers.

BBE - BBE high definition audio adds natural, clear and extraordinary sound quality to any program.



Press the SOUND button



To select HYPER SURROUND or BBE



To choose the setting



Press the EXIT when finished



Note: BBE is a registered trademark of BBE Sound, Inc. For U.S., licensed from BBE Sound, Inc. under USP 4638258, 4482866 and 5510572. For Canada, licensed from BBE Sound, Inc. BBE is a registered trademark of BBE Sound, Inc.

Hyper Surround

RM-C1255G and RM-C1254G only

Creates a deep, three-dimensional sound effect by channeling the audio through the TV's front-firing speakers. Press the HYPER SURR. (Hyper Surround) button to turn the effect on or off.

HYPER SURROUND ON OFF

Game

RM-C1255G and RM-C203 only

Sets automatically the proper conditions for playing video game (previously connected in the front input).



Press the GAME button

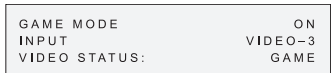

Button Functions

TheaterPro D6500K

RM-C1253G and RM-C1254G only

The TheaterPro D6500K color temperature technology function makes sure that the video you watch is set to the standard color temperature, so that what you see is as true to what the film to video editors intended it to be.



Press the THEATER PRO button

Input

Selects the signal input source for the television: TV (for Antenna or Cable) or Video-1, 2, or V2-Component or Video-3 for video devices like VCR's, DVD players, or camcorders.



Press the INPUT button

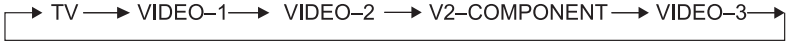

C.C. (Closed Caption)

Use the C.C. (Closed Caption) button to select the mode of closed caption.



Press the C.C. button



- See page 34 when you set the caption/text mode.

TV/CATV Slide Switch

RM-C1253G, RM-C1254G, RM-C1255G only

Use either the television's own tuner or a cable box to select channels. Set this switch to **TV** to operate the television's built-in tuner. Move the switch to **CATV** to operate a cable box.

Note:

- See page 20 for information on programming your remote for cable box operation.

Button Functions

VCR/DVD Slide Switch

RM-C1253G, RM-C1254G, RM-C1255G only

You can control a VCR or DVD player with the buttons on the lower part of the remote control. Move the slide switch to **VCR** or **DVD** to operate.

Notes:

- The remote is preset with the code 000 to control JVC-brand VCR's. For any other manufacturer's brand VCR, please see the code chart and instructions on page 21.
- The remote is preset with the code 000 to control JVC-brand DVD players. For any other manufacturer's brand DVD player, please see the code chart and instructions on page 22.

VCR Buttons

Note: The RM-C203 remote controls can only be used with JVC-brand VCRs

You can use this remote control to operate the basic functions of your VCR. These functions include: play, record, rewind, fast-forward, stop, pause, channel scan, TV/VCR, power on, and power off.

Move the selector switch to **VCR** to operate.

- The remote is preset with the code 000 to control JVC-brand VCR's. For any other manufacturer's brand VCR, please see the code chart and instructions on page 21.

DVD Buttons

RM-C1253G, RM-C1254G, RM-C1255G only

You can also use this remote control to operate the basic functions of your DVD player. These functions include: play, rewind, fast-forward, stop, still/pause, previous/next, tray open/close, power on, and power off.

Move the selector switch to **DVD** to operate.

- The remote is preset with the code 000 to control JVC-brand DVD players. For any other manufacturer's brand DVD player, please see the code chart and instructions on page 22.

Light

RM-C1253G only

Your remote control includes illuminated buttons for key features like channel +/- and Volume +/- . Press the **LIGHT** button to turn the illumination on for 4 seconds.

Troubleshooting

| PROBLEMS | CHECK |
|--|---|
| There is no power | <ul style="list-style-type: none"> • See if the power cord became unplugged. • Check for a blown fuse or circuit breaker or a power outage. |
| There is no picture or sound | <ul style="list-style-type: none"> • The antenna could be disconnected. • The input mode could be set improperly. See page 45. • The tuner (Auto Tuner Setup) could be set improperly. See page 26. • The TV station may be having difficulties. Check to see if other stations are working. |
| Remote control is not operating properly or at all | <ul style="list-style-type: none"> • Check to see that the batteries are still working and properly installed. • Make sure the remote has a clear sight path to the TV. • Check that the TV/CATV switch is in the proper position. (Except for RM-C203). • You may be too far from the TV. You must be within 23 feet (7 meters). |
| You cannot select a certain channel | <ul style="list-style-type: none"> • Make sure the channels have been programmed. See "Channel Summary", page 26. • Check to see if the channel is locked. See "Channel Summary - Lock" page 26. |
| The power turns off by itself | <ul style="list-style-type: none"> • Make sure the set did not become unplugged. • Perhaps the On/Off Timer is set. See page 40. • Check to see if the Sleep Timer was set. See page 42. |
| The clock is wrong | <ul style="list-style-type: none"> • The power was interrupted and the clock was not reset. See page 39. |
| The On Timer is blinking | <ul style="list-style-type: none"> • There is a problem with the TV. Unplug the set and call for service. |
| The color quality is poor | <ul style="list-style-type: none"> • Tint and Color may be improperly adjusted. See page 36. • The Video Status mode may be turned to the wrong setting. See page 43. |
| There are lines across the picture | <ul style="list-style-type: none"> • There could be interference from another electrical appliance, such as a computer, another TV or VCR. Move any such appliances further away from the TV. |
| The picture is spotted | <ul style="list-style-type: none"> • There could be interference from a high-wattage appliance, like a hairdryer or vacuum, operating nearby. Move the antenna away from the appliance or change to a coaxial cable connection which is less prone to interference. |
| There are double pictures (ghosts) | <ul style="list-style-type: none"> • A building or passing airplane can reflect the original signal and produce a second, slightly delayed one. Adjust your antenna position. |
| Picture is snowy (image noise) | <ul style="list-style-type: none"> • Your antenna may be damaged, disconnected or turned. Check the antenna connection. If the antenna is damaged, replace it. |
| Screen is 40% black | <ul style="list-style-type: none"> • The Closed Caption Text mode is on. Turn it off in the Closed Caption Menu, page 45. |
| Stereo or bilingual programs can't be heard | <ul style="list-style-type: none"> • Make sure the MTS settings are correct. See "MTS" on page 38. |
| Static electricity | <ul style="list-style-type: none"> • It is normal to feel static electricity if you brush or touch the screen. |
| You hear occasional crackling sounds | <ul style="list-style-type: none"> • It is normal for the TV to make crackling sounds when first turned on or off. Unless the sound or picture become abnormal, this is fine. |

For Canadian model televisions, see the separate sheet for Canadian Warranty information.

JVC COMPANY OF AMERICA warrants this product and all parts thereof, except as set forth below **ONLY TO THE ORIGINAL PURCHASER AT RETAIL** to be **FREE FROM DEFECTIVE MATERIALS AND WORKMANSHIP** from the date of original retail purchase for the period shown below (the "Warranty Period") (PICTURE TUBE is covered for Two (2) years.)

| | |
|---------------|---------------|
| Parts | Labor |
| 1 YEAR | 1 YEAR |

THIS LIMITED WARRANTY IS VALID ONLY IN THE FIFTY (50) UNITED STATES, THE DISTRICT OF COLUMBIA AND COMMONWEALTH OF PUERTO RICO.

WHAT WE WILL DO:

If this product is found to be defective within the warranty period, JVC will repair or replace defective parts at no charge to the original owner. Such repair and replacement services shall be rendered by JVC during regular business hours at JVC authorized service centers. Parts used for replacement are warranted only for the remainder of this Warranty Period. All products and parts thereof may be brought to a JVC authorized service center on a carry-in basis. Televisions with a screen size of 25 inches and larger may be covered on an in-home basis where such service is available.

WHAT YOU MUST DO FOR WARRANTY SERVICE:

To determine if in-home service is available in your area, either contact the selling dealer (retailer) or call 1-800-537-5722 to locate the nearest JVC authorized service center. Service locations can also be obtained from our website <http://www.jvcservice.com>. In-home service, if available, will require clear access to the Television by the service representatives. If in-home service is not available, carry in service will be provided.

If service is not locally available, box the product carefully, preferably in its original carton, and ship, insured, with a copy of your bill of sale plus a letter of explanation of the problem to the nearest JVC Factory Service Center, the name and location which will be given to you by the toll free number.

If you have any questions concerning your JVC Product, please contact our Customer Relations Department.

WHAT IS NOT COVERED:

This limited warranty provided by JVC does not cover:

- 1) Products which have been subject to abuse, accident, alteration, modification, tampering, negligence, misuse, faulty installation, lack of reasonable care, or if repaired or serviced by anyone other than a service facility authorized by JVC to render such service, or if affixed to any attachment not provided with the products, or if the model or serial number has been altered, tampered with, defaced or removed;
- 2) Initial installation, installation and removal from "built-in" entertainment centers and other mounting systems;
- 3) Operational adjustments covered in the Owner's Manual, normal maintenance, video and audio head cleaning;
- 4) Damage that occurs in shipment, due to an act of God, and cosmetic damage;
- 5) Signal reception problems and failures due to line power surge;
- 6) Video Pick-up Tubes/CCD Image Sensor, Cartridge, Stylus (Needle) are covered for 90 days from the date of purchase;

- 7) Accessories;
 8) Batteries (except that Rechargeable Batteries are covered for 90 days from date of purchase.)

There are no express warranties except as listed above.

THE DURATION OF ANY IMPLIED WARRANTIES, INCLUDING THE IMPLIED WARRANTY OF MERCHANTABILITY, IS LIMITED TO THE DURATION OF THE EXPRESS WARRANTY HEREIN.

JVC SHALL NOT BE LIABLE FOR THE LOSS OF USE OF THE PRODUCT, INCONVENIENCE, OR ANY OTHER DAMAGES, WHETHER DIRECT, INCIDENTAL OR CONSEQUENTIAL (INCLUDING, WITHOUT LIMITATION, DAMAGE TO TAPES, RECORDS OR DISCS) RESULTING FROM THE USE OF THIS PRODUCT, OR ARISING OUT OF ANY BREACH OF THIS WARRANTY, ALL EXPRESS AND IMPLIED WARRANTIES, INCLUDING THE WARRANTIES OF MERCHANTABILITY AND FITNESS FOR PARTICULAR PURPOSE, ARE LIMITED TO THE WARRANTY PERIOD SET FORTH ABOVE.

Some states do not allow the exclusion of incidental or consequential damages or limitations on how long the warranty lasts, so these exclusions or limitations may not apply to you. This warranty gives you specific legal rights and you may also have other rights which vary state to state.

JVC COMPANY OF AMERICA
 DIVISION OF JVC AMERICAS CORP.

1700 Valley Road
 Wayne, New Jersey 07470

<http://www.jvcservice.com>

REFURBISHED PRODUCTS CARRY A SEPARATE WARRANTY. THIS WARRANTY DOES NOT APPLY FOR DETAILS OF REFURBISHED PRODUCT WARRANTY. PLEASE REFER TO THE REFURBISHED PRODUCT WARRANTY INFORMATION PACKAGED WITH EACH REFURBISHED PRODUCT.

For customer use:

Enter below the Model No. and Serial No. which is located either on the rear, bottom or side of the cabinet.

Retain this information for future reference.

Model No.: _____

Serial No.: _____

Purchase Date: _____

Name Of Dealer: _____

Authorized Service Centers

QUALITY **JVC** SERVICE

HOW TO LOCATE YOUR JVC SERVICE CENTER

TOLL FREE: 1 (800) 537-5722

<http://www.jvc.com>

Dear Customer,

In order to receive the most satisfaction from your purchase, please read the instruction booklet before operating the unit. In the event that repairs are necessary, please call 1 (800) 537-5722 for your nearest authorized servicer or visit our website at **www.JVC.com**

Remember to retain your Bill of Sale for Warranty Service.

————— **Do not service the television yourself** —————

Caution

To prevent electrical shock, do not open the cabinet. There are no user serviceable parts inside. Please refer to qualified service personnel for repairs.

Accessories

To purchase accessories for your JVC product, please call toll free: 1 (800) 882-2345 or on the web at **www.JVC.com**

Specifications

| MODEL | AV-20D304 | AV-27430 AV-27432 | AV-27D304 AV-27D104 | AV-32430 AV-32432 |
|-------------------------------|---|---|--|---|
| Reception Format | NTSC, BTSC System (Multi-Channel Sound) | | | |
| Reception Range | VHF 2 to 13, UHF 14 to 69 Sub Mid, Mid, Super, Hyper and Ultra bands (181 channel frequency synthesizer system) | | | |
| Power Source | AC 120V, 60Hz | | | |
| Power Consumption | 75W | 105W | 105W | 128W |
| Screen Size | 20 inch / 51 cm measured diagonally full square | 27 inch / 68 cm measured diagonally full square | | 32 inch / 80 cm measured diagonally full square |
| Audio Output | 1.2W + 1.2W | | | 3W + 3W |
| Speakers | 2 x 3 1/2 / 5x9 cm oval x 2 | | | |
| Antenna Terminal | 75 ohms (VHF/UHF) (F-type connector) | | | |
| External Input Jacks | Video: 1 Vp-p, 75 ohms Audio: 500mVrms (-4dBs) high impedance | | | |
| S-Video Input Jack | Y: 1Vp-p positive, 75 ohms (negative sync provided) C: 0.286 Vp-p (burst signal), 75 ohms | | | |
| Component Input Jacks | Y: 1Vp-p positive, 75 ohms (negative sync provided) Pb/Pr: 0.7 Vp-p, 75 ohms | | | |
| Audio Output (FIX) | 500mVrms (-4dBs) Low impedance (400 Hz when modulated 100%) | | | |
| Headphone Jack | Ø3.5 mm x 1 | — | | |
| Dimensions (In) WxHxD (cm) | 23 3/8 x 18 x 19 1/4 59.2 x 45.6 x 48.7 | 25 3/4 x 23 3/8 x 19 1/2 65.4 x 59.3 x 49.4 | 29 5/8 x 23 1/4 x 23 75.2 x 59.0 x 53.1 | 30 1/4 x 26 1/4 x 21 1/2 76.8 x 66.7 x 54.7 |
| Weight (lbs / kg) | 45.0 / 20.4 | 68.5 x 31.1 | 70.8 / 32.2 | 112.2 / 51.0 |
| Accessories | Remote control unit x 1, AA batteries x 2 or Lithium cell battery x 1 | | | |

Specifications subject to change without notice.

JVC COMPANY OF AMERICA
Division of JVC Americas Corp.
1700 Valley Road
Wayne, New Jersey, 07470



JVC CANADA, INC.
21 Finchdene Square
Scarborough, Ontario
Canada, M1X 1A7

Free Manuals Download Website

<http://myh66.com>

<http://usermanuals.us>

<http://www.somanuals.com>

<http://www.4manuals.cc>

<http://www.manual-lib.com>

<http://www.404manual.com>

<http://www.luxmanual.com>

<http://aubethermostatmanual.com>

Golf course search by state

<http://golfingnear.com>

Email search by domain

<http://emailbydomain.com>

Auto manuals search

<http://auto.somanuals.com>

TV manuals search

<http://tv.somanuals.com>