

# JVC



## COMPACT COMPONENT SYSTEM

KOMPAKTES KOMPLEMENTENSYSTEM  
SYSTEME DE COMPOSANTS COMPACT  
KOMPACTO KOMPONENTEN-SYSTEEM  
SISTEMA DE COMPONENTES COMPACT  
IMPIANTO A COMPONENTI COMPATTO

# CA-D551TR/CA-D451TR/ CA-D351TR

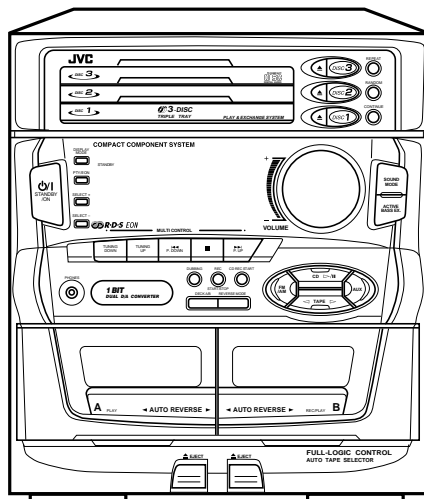

COMPACT  
**disc**  
DIGITAL AUDIO

 **R-D-S EON**

**INSTRUCTIONS**  
**BEDIENUNGSANLEITUNG**  
**MANUEL D'INSTRUCTIONS**  
**GEBRUIKSAANWIJZING**  
**MANUAK DE INSTRUCCIONES**  
**ISTRUZIONI**

**For Customer Use:**

Enter below the Model No. and Serial No. which are located either on the rear, bottom or side of the cabinet. Retain this information for future reference.

Model No. \_\_\_\_\_

Serial No. \_\_\_\_\_

FMUN9016-661M  
[ E, G ]

## Warnings, Cautions and Others / Warnung, Achtung und sonstige Hinweise / Mises en garde, précautions et indications diverses / Waarschuwingen, voorzorgen en andere mededelingen / Avisos, precauciones y otras notas / Avvertenze e precauzioni da osservare

### IMPORTANT for the U.K.

**DO NOT** cut off the mains plug from this equipment. If the plug fitted is not suitable for the power points in your home or the cable is too short to reach a power point, then obtain an appropriate safety approved extension lead or consult your dealer.

**BE SURE** to replace the fuse only with an identical approved type, as originally fitted.

If nonetheless the mains plug is cut off ensure to remove the fuse and dispose of the plug immediately, to avoid a possible shock hazard by inadvertent connection to the mains supply.

If this product is not supplied fitted with a mains plug then follow the instructions given below:

### IMPORTANT:

**DO NOT** make any connection to the terminal which is marked with the letter E or by the safety earth symbol or coloured green or green-and-yellow.

The wires in the mains lead on this product are coloured in accordance with the following code:

Blue : Neutral  
Brown : Live

As these colours may not correspond with the coloured markings identifying the terminals in your plug proceed as follows:

The wire which is coloured blue must be connected to the terminal which is marked with the letter N or coloured black.

The wire which is coloured brown must be connected to the terminal which is marked with the letter L or coloured red.

**IF IN DOUBT - CONSULT A COMPETENT ELECTRICIAN.**

### Per l'Italia:

"Si dichiara che il questo prodotto di marca JVC è conforme alle prescrizioni del Decreto Ministeriale n.548 del 28/08/95 pubblicato sulla Gazzetta Ufficiale della Repubblica Italiana n.301 del 28/12/95."

### Caution — POWER switch!

Disconnect the mains plug to shut the power off completely. The POWER switch in any position does not disconnect the mains line. The power can be remote controlled.

### Achtung — POWER-Schalter!

Den Netzstecker aus der Steckdose ziehen, um die Stromversorgung vollkommen zu unterbrechen. Der Schalter POWER unterbricht in keiner Stellung die Stromversorgung vollkommen. Die Stromversorgung kann mit der Fernbedienung ein- und ausgeschaltet werden.

### Attention — Commutateur POWER!

Déconnecter la fiche de secteur pour couper complètement le courant. Le commutateur POWER ne coupe jamais complètement la ligne de secteur, quelle que soit sa position. Le courant peut être télécommandé.

### Opgelet — POWER schakelaar!

Om de stroomtoevoer geheel uit te schakelen, trekt u de stekker uit het stopcontact. Anders zal er altijd een geringe hoeveelheid stroom naar het apparaat lopen, ongeacht de stand van de POWER schakelaar. U kunt het apparaat ook met de afstandsbediening aan- en uitschakelen.

### ¡Atención — Interruptor POWER!

Desconectar el cable de alimentación para desactivar la alimentación totalmente. Cualquiera que sea la posición de ajuste del interruptor POWER, la alimentación no es cortada completamente. La alimentación puede ser controlada remotamente.

### Attenzione — L'interruttore POWER!

Disinserire la spina del cavo di alimentazione dalla presa della rete elettrica per staccare completamente l'alimentazione. L'interruttore POWER in nessuna posizione stacca la linea di alimentazione elettrica principale. È possibile il controllo remoto dell'alimentazione.

### CAUTION

To reduce the risk of electrical shocks, fire, etc.:

1. Do not remove screws, covers or cabinet.
2. Do not expose this appliance to rain or moisture.

### ACHTUNG

Zur Verhinderung von elektrischen Schlägen, Brandgefahr, usw.:

1. Keine Schrauben lösen oder Abdeckungen entfernen und das Gehäuse nicht öffnen.
2. Dieses Gerät weder Regen noch Feuchtigkeit aussetzen.

### ATTENTION

Afin d'éviter tout risque d'électrocution, d'incendie, etc.:

1. Ne pas enlever les vis ni les panneaux et ne pas ouvrir le coffret de l'appareil.
2. Ne pas exposer l'appareil à la pluie ni à l'humidité.

### VOORZICHTIG

Ter vermindering van gevaar voor brand, elektrische schokken, enz.:

1. Verwijder geen schroeven, panelen of de behuizing.
2. Stel het toestel niet bloot aan regen of vocht.

### PRECAUCIÓN

Para reducir riesgos de choques eléctricos, incendio, etc.:

1. No extraiga los tornillos, los cubiertas ni la caja.
2. No exponga este aparato a la lluvia o a la humedad.

### ATTENZIONE

Per ridurre il rischio di shock elettrici, incendi, ecc.:

1. Non togliate viti, coperchi o la scatola.
2. Non esponete l'apparecchio alla pioggia e all'umidità.

### Caution: Proper Ventilation

To avoid risk of electric shock and fire, and to prevent damage, locate the apparatus as follows:

- 1 Front:  
No obstructions and open spacing.
- 2 Sides/ Top/ Back:  
No obstructions should be placed in the areas shown by the dimensions below.
- 3 Bottom:  
Place on the level surface. Maintain an adequate air path for ventilation by placing on a stand with a height of 10 cm or more.

### Vorsicht: Ausreichende Belüftung

Zur Vermeidung von elektrischen Schlägen, Feuer und sonstigen Schäden sollte das Gerät unter folgenden Bedingungen aufgestellt werden:

- 1 Vorderseite:  
Hindernisfrei und gut zugänglich.
- 2 Seiten- und Rückwände:  
Hindernisfrei in allen gegebenen Abständen (s. Abbildung).
- 3 Unterseite:  
Die Stellfläche muß absolut eben sein. Sorgen Sie für ausreichende Luftzufuhr durch Aufstellung auf einem Stand mit mindestens 10 cm Höhe.

### Attention: Aération correcte

Pour prévenir tout risque de décharge électrique ou d'incendie et éviter toute détérioration, installez l'appareil de la manière suivante:

- 1 Avant:  
Bien dégagé de tout objet.
- 2 Côtés/dessus/dessous:  
Assurez-vous que rien ne bloque les espaces indiqués sur le schéma ci-dessous.
- 3 Dessous:  
Posez l'appareil sur une surface plane et horizontale. Veillez à ce que sa ventilation correcte puisse se faire en le plaçant sur un support d'au moins dix centimètres de hauteur.

### Voorzichtig: Goede ventilatie vereist

Om brand, elektrische schokken en beschadiging te voorkomen, moet u het toestel als volgt opstellen:

- 1 Voorkant:  
Geen belemmeringen en voldoende ruimte.
- 2 Zijkanten/boven-/onderkant:  
Geen belemmeringen plaatsen in de hieronder aangegeven zones.
- 3 Onderkant:  
Op vlakke ondergrond plaatsen. Voldoende ventilatieruimte voorzien door het toestel op een onderstel met een hoogte van 10 cm of meer te plaatsen.

### Precaucion: ventilación correcta

Para evitar el riesgo de descargas eléctricas e incendio y prevenir posibles daños, instale el equipo en un lugar que cumpla los siguientes requisitos:

- 1 Parte frontal:  
Sin obstrucciones, espacio abierto.
- 2 Lados/parte superior/parte posterior:  
No debe haber ninguna obstrucción en las áreas mostradas por las dimensiones de la siguiente figura.
- 3 Parte inferior:  
Sitúe el equipo sobre una superficie nivelada. Mantenga un espacio adecuado para permitir el paso del aire y una correcta ventilación, situando el equipo sobre un soporte de 10 o más cm de altura.

### Attenzione: Per una corretta ventilazione

Per prevenire il rischio di scosse elettriche e di incendio ed evitare possibili danni, collocare le apparecchiature nel modo seguente:

- 1 Parte anteriore:  
Nessun ostacolo e spazio libero.
- 2 Lati/Parte superiore/Retro:  
Lasciare libere le zone indicate dalle dimensioni di seguito.
- 3 Base:  
Collocare su una superficie piana. Consentire un'adeguata ventilazione dell'impianto appoggiandolo su un tavolino alto almeno 10 cm.

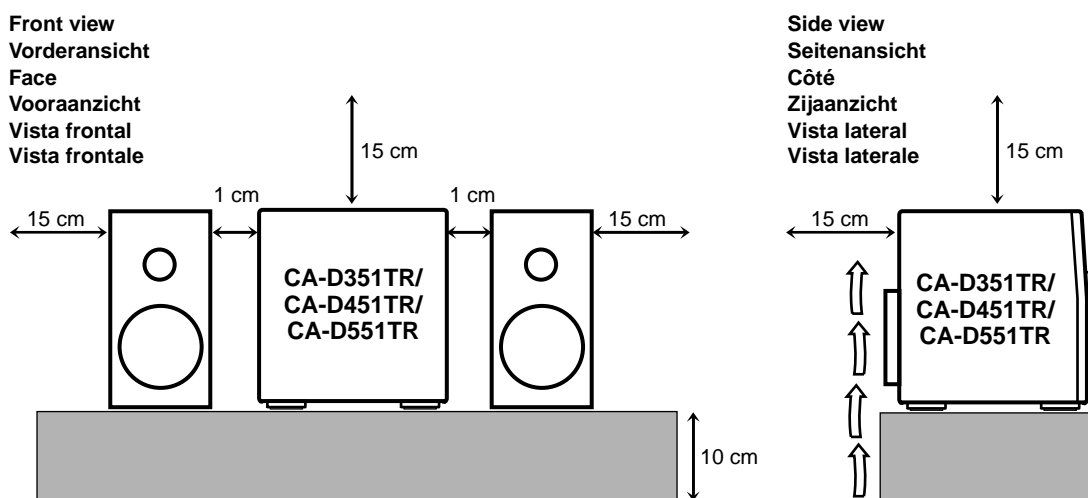

**IMPORTANT FOR LASER PRODUCTS/WICHTIGER HINWEIS FÜR LASER-PRODUKTE / IMPORTANT POUR LES PRODUITS LASER / BELANGRIJKE INFORMATIE VOOR LASERPRODUKTEN / IMPORTANTE PARA LOS PRODUCTOS LÁSER / IMPORTANTE PER I PRODOTTI LASER**

**REPRODUCTION OF LABELS/ANBRINGUNGSORTE FÜR LASER-PRODUKTE/REPRODUCTION DES ETIQUETTES/VERKLARING VAN DE LABELS/REPRODUCCIÓN DE ETIQUETAS/RIPRODUZIONE DELLE ETICHETTE**

- |  |   |
|--|---|
| ① CLASSIFICATION LABEL, PLACED ON REAR ENCLOSURE                     | ② WARNING LABEL, PLACED INSIDE THE UNIT                         |
| ① KLASSIFIKATIONSETIKETTE AN DER RÜCKSEITE                           | ② WARNETIKETTE IM GERÄTEINNEREN                                 |
| ① ETIQUETTE DE CLASSIFICATION, PLACÉE A L'ARRIÈRE DU COFFRET         | ② ETIQUETTE D'AVERTISSEMENT PLACÉE À L'INTERIEUR DE L'APPAREIL  |
| ① KLASSIFIKATIELABEL, OP DE ACHTERZIJDE VAN HET APPARAAT             | ② WAARSCHUWINGSLABEL, IN HET APPARAAT                           |
| ① ETIQUETA DE CLASIFICACIÓN, PEGADA EN LA PARTE POSTERIOR DE LA CAJA | ② ETIQUETA DE ADVERTENCIA, PEGADA EN EL INTERIOR DE LA UNIDAD   |
| ① ETICHETTA DI CLASSIFICAZIONE, SITUATA SUL RIVESTIMENTO POSTERIORE  | ② ETICHETTA DI AVVERTENZA, SITUATA ALL'INTERNO DELL'APPARECCHIO |

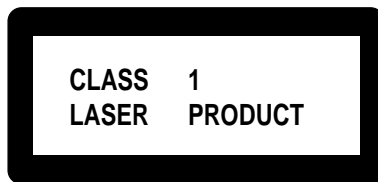

**DANGER:** Invisible laser radiation when open and interlock failed or defeated. AVOID DIRECT EXPOSURE TO BEAM. (e)

**WARNING:** Osynlig laserstrålning när denna del är öppen och spärren är urkopplad. Beträkta ej strålen. (s)

**ADVARSEL:** Usynlig laserstrålning ved åbning, når sikkerhedsafbrydere er ude af funktion. Undgå udsættelse for stråling (d)

**VARO:** Avattaessa ja suojalukitus ohitettaessa olet alttiina näkymättömälle lasersäteilylle. Älä katso säteeseen. (f)

1. CLASS 1 LASER PRODUCT
2. **DANGER:** Invisible laser radiation when open and interlock failed or defeated. Avoid direct exposure to beam.
3. **CAUTION:** Do not open the top cover. There are no user serviceable parts inside the Unit; leave all servicing to qualified service personnel.

1. LASER-PRODUKT DER KLASSE 1
2. **GEFAHR:** Unsichtbare Laserstrahlung bei Öffnung und fehlerhafter oder beschädigter Sperr. Direkten Kontakt mit dem Strahl vermeiden!
3. **ACHTUNG:** Das Gehäuse nicht öffnen. Das Gerät enthält keinerlei Teile, die vom Benutzer gewartet werden können. Überlassen Sie Wartungsarbeiten bitte qualifizierten Kundendienst-Fachleuten.

1. PRODUIT LASER CLASSE 1
2. **ATTENTION:** Radiation laser invisible quand l'appareil est ouvert ou que le verrouillage est en panne ou désactivé. Eviter une exposition directe au rayon.
3. **ATTENTION:** Ne pas ouvrir le couvercle du dessus. Il n'y a aucune pièce utilisable à l'intérieur. Laisser à un personnel qualifié le soin de réparer votre appareil.

1. KLAS 1 LASERPRODUKT
2. **GEVAARLIJK:** Onzichtbare laserstraling wanneer open en de beveiliging faalt of uitgeschakeld is. Voorkom het direct blootstaan aan de straal.
3. **VOORZICHTIG:** De bovenkap niet openen. Binnenin het toestel bevinden zich geen door de gebruiker te repareren onderdelen: laat onderhoud over aan bekwaam vakpersoneel.

1. PRODUCTO LASER CLASE 1
2. **PELIGRO:** En el interior hay radiación láser invisible. Evite el contacto directo con el haz.
3. **PRECAUCIÓN:** No abra la tapa superior. En el interior de la unidad no existen piezas reparables por el usuario; deje todo servicio técnico en manos de personal calificado.

1. PRODOTTO LASER CLASSE 1
2. **PERICOLO:** Radiazione laser invisibile quando l'apparecchio è aperto ed il dispositivo di sicurezza è guasto o disattivato. Evitare l'esposizione diretta ai raggi.
3. **ATTENZIONE:** Non aprire il coperchio superiore. Non vi sono parti adoperabili dall'utente all'interno di questo apparecchio; lasciare tutti i controlli a personale qualificato.

Thank you for purchasing the JVC Compact Component System.  
We hope it will be a valued addition to your home, giving you years of enjoyment.  
Be sure to read this instruction manual carefully before operating your new stereo system.  
Here you will find all the information you need to set up and use the system.  
For questions that are not answered in the manual, please contact your dealer.

## Features

Easy operation



Great sound



Triple Tray

Here are some of the things that make your System powerful and easy to use.

- The controls and operations have been redesigned to make them very easy to use, so you can spend your time listening to music.
  - With the One Touch Operation feature of JVC's **COMPU PLAY** you can turn on the System and start the radio, the Cassette Deck, or the CD Player with a single touch.
- To get such great sound from such a compact package the System has:
  - Programmed sound mode includes live surround effects **D. CLUB, HALL, and STADIUM**. It also includes S.E.A (Sound Effect Amplifier) effects **ROCK, CLASSIC, and POP**.
- The System is compatible with RDS (Radio Data System) broadcasting.
  - The EON data enables you to standby for desired information.
  - The PTY Search function searches for programmes in the category you wish.
 In addition, Radio Text can be displayed using data sent by station.
- CD changer function can operate 3 discs.
  - Discs can be changed during play using the **TRIPLE TRAY**.
  - Continuous, random or program play of 3 discs.
- Includes a timer for recording broadcasts while you are out, and an easy-to-use Sleep timer.

## How This Manual Is Organized

In this manual we have incorporated some special features:

- Basic information that is the same for many different functions is grouped in one place, and not repeated in each procedure. For instance, in the section on playing a CD, we do not repeat the information about setting the volume and the sound conditions, which are discussed in the Common Operations section.
- Name of buttons and controls are written in all capital letters like this: **SOUND MODE**.
- When we are talking about the Function, rather than the **BUTTON** or **DISPLAY**, only the first letter is capitalized.

The manual has a table of contents to help you quickly look up what you want to know.

We've enjoyed making this manual for you, and hope you will use it to enjoy the sound and many features built into your System.

## IMPORTANT CAUTIONS

### 1. Installation of the Unit

- Select a place which is level, dry and neither too hot nor too cold. (Between 5°C and 35°C or 41°F and 95°F.)
- Leave sufficient distance between the Unit and a TV.
- Do not use the Unit in a place subject to vibrations.

### 2. Power cord

- Do not handle the power cord with wet hands!
- Some power (12 watts) is always consumed as long as the power cord is connected to the wall outlet.
- When unplugging the Unit from the wall outlet, always pull the plug, not the power cord.

### 3. Malfunctions, etc.

- There are no user serviceable parts inside. If anything goes wrong, unplug the power cord and consult your dealer.
- Do not insert any metallic object into the Unit.

# Table of Contents

Features .....	1	<b>Using the CD Player .....</b>	<b>16</b>
How This Manual Is Organized .....	1	The Quickest Way To Start a CD Is With the	
IMPORTANT CAUTIONS .....	1	One Touch Operation .....	17
		To Insert Discs .....	17
<b>Getting Started .....</b>	<b>3</b>	Basics of Using the CD Player — Normal Play .....	18
Accessories .....	3	To Play a Disc .....	18
How To Put Batteries In the Remote Control .....	3	To Select a Disc, Track Or Passage	
Using the Remote Control .....	3	Within a Track .....	18
Connecting the FM Antenna .....	4	Locating a Track With the Remote Control	
Connecting the AM (MW/LW) Antenna .....	4	Directly .....	18
Connecting the Speakers .....	5	To Change Discs While Playing .....	18
For CA-D551TR .....	5	Continuous Play .....	19
For CA-D451TR or CA-D351TR .....	5	Programming the Playing Order of the Tracks .....	19
Connecting Auxiliary Equipment .....	6	Random Play .....	20
COMPU PLAY .....	6	Repeating a Selection or the Discs .....	21
		Tray Lock Function .....	21
<b>Common Operations .....</b>	<b>7</b>	Locking the Electronic Lock .....	21
Turning the Power On and Off .....	7	Unlocking the Electronic Lock .....	21
Turning the System On .....	7		
Turning the System Off .....	7	<b>Using the Cassette Deck</b>	
Adjusting the Volume .....	8	<b>(Listening to a Tape) .....</b>	<b>22</b>
Reinforcing the Bass Sound .....	8	One Touch Play .....	22
Sound Modes .....	8	Regular Play .....	22
Listening to Auxiliary Equipment .....	9	Fast Left And Fast Right .....	23
		Music Scan .....	23
<b>Using the Tuner .....</b>	<b>10</b>	To Find the Beginning of the Current Selection ....	23
One Touch Radio .....	10	To Find the Beginning of the Next Selection ....	23
Tuning In a Station .....	10	Reverse Mode .....	23
Switching between Frequency Bands .....	10		
Three ways to select a station .....	11	<b>Using the Cassette Deck (Recording) .....</b>	<b>24</b>
Presetting Stations .....	11	Things To Know Before You Start Recording ....	24
To Change the FM Reception Mode .....	11	Standard Recording .....	25
Receiving FM Stations with RDS .....	12	To Record Any Sound Source To Tape .....	25
What Information RDS can Provide .....	12	CD Direct Recording .....	26
Changing the Display .....	13	Tape to Tape Recording (Dubbing) .....	26
Searching for Programmes by PTY codes .....	13	How to Use the DUBBING Button .....	26
EON Function .....	14		
ALARM function .....	15	<b>Using the Timer .....</b>	<b>27</b>
		Setting the Clock .....	27
		Setting the Timer .....	28
		Setting the SLEEP Timer .....	29
		<b>Care And Maintenance .....</b>	<b>30</b>
		<b>Troubleshooting .....</b>	<b>31</b>
		<b>Specifications .....</b>	<b>32</b>

## Accessories

Check that you have all of the following items, which are supplied with the System.

- AM (MW/LW) Loop Antenna (1)
- Remote Control (1)
- Batteries (2)
- FM Wire Antenna (1)

If any of these items is missing, contact your dealer immediately.

## How To Put Batteries In the Remote Control

Match the polarity (+ and -) on the batteries with the + and - markings in the battery compartment.

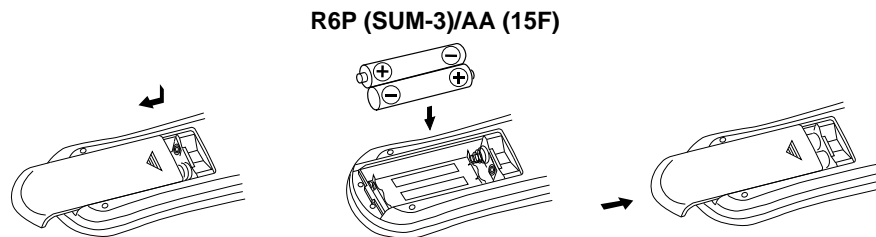

### **CAUTION: Handle batteries properly.**

To avoid battery leakage or explosion:

- Remove batteries when the Remote Control will not be used for a long time.
- When you need to replace the batteries, replace both batteries at the same time with new ones.
- Don't use an old battery with a new one.
- Don't use different types of batteries together.

## Using the Remote Control

The Remote Control makes it easy to use many of the functions of the System from a distance of up to 7m (23 feet) away.

You need to point the Remote Control at the remote sensor on the System's front panel.

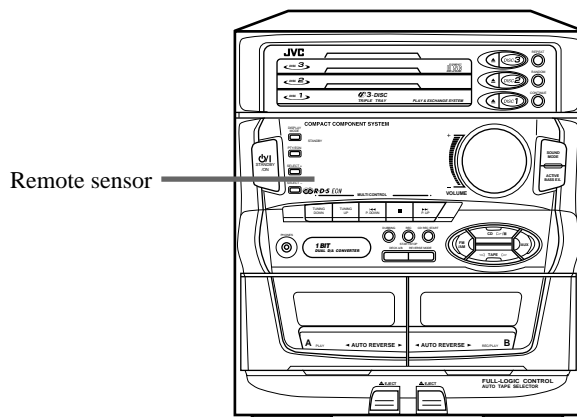

**CAUTION: Make all connections before plugging the Unit into an AC power outlet.**

## Connecting the FM Antenna

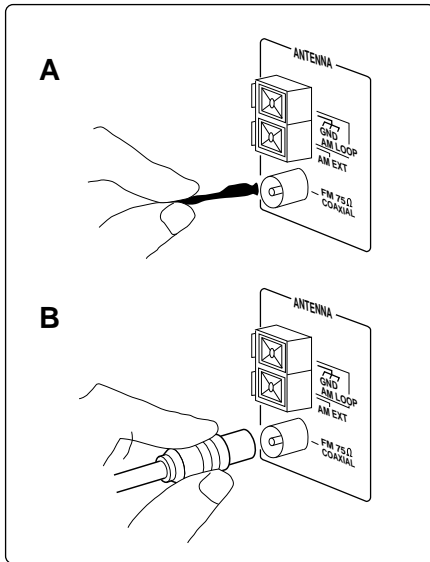

### A. Using the Supplied Wire Antenna

The FM Wire Antenna provided can be connected to a FM 75-ohm COAXIAL as temporary measure. Extend the supplied wire antenna horizontally.

### B. Using the Standard Type Connector (Not Supplied)

A standard type connector (IEC or DIN 45325) should be connected to the FM 75-ohm COAXIAL terminal.

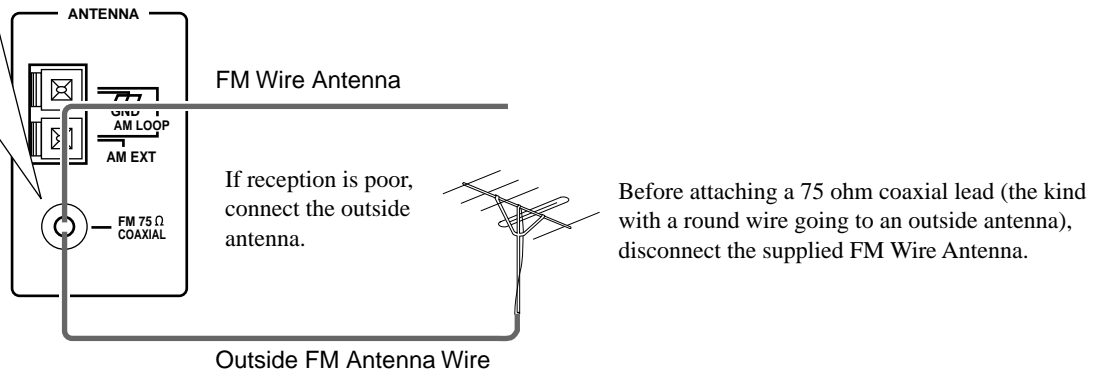

Before attaching a 75 ohm coaxial lead (the kind with a round wire going to an outside antenna), disconnect the supplied FM Wire Antenna.

**CAUTION: To avoid noise, keep antennas away from metallic parts of the System, connecting cord and the AC power cord.**

## Connecting the AM (MW/LW) Antenna

AM Antenna Wire (Not supplied)      If reception is poor, connect the outside antenna.

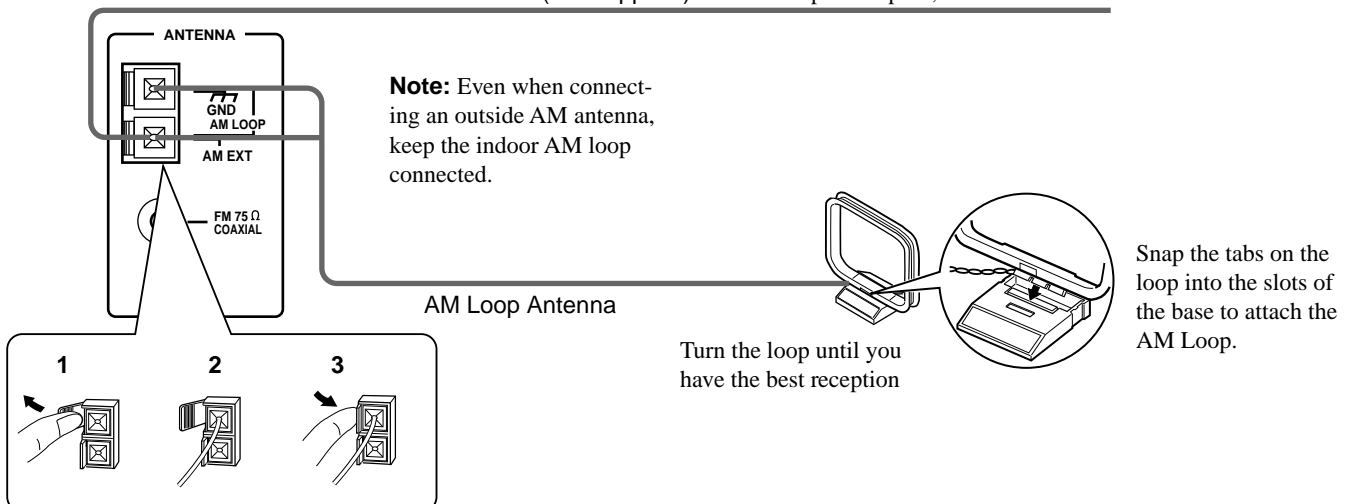



**CAUTION: Make all connections before plugging the Unit into an AC power outlet.**

## Connecting the Speakers

■ Please refer to instructions for speakers as well when you connect speakers.

### For CA-D551TR

For each speaker, connect one end of the speaker wire to the speaker terminals on the back of the System and the other end to the speaker.

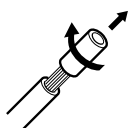

1. Open each of the terminals and insert the speaker wires firmly (be sure to remove the insulation at the end of each wire first), then close the terminals.
2. Connect the red (+) and black (-) terminals of the right side speaker to the red (+) and black (-) terminals marked RIGHT on the System.  
Connect the red (+) and black (-) terminals of the left side speaker to the red (+) and black (-) terminals marked LEFT on the System.

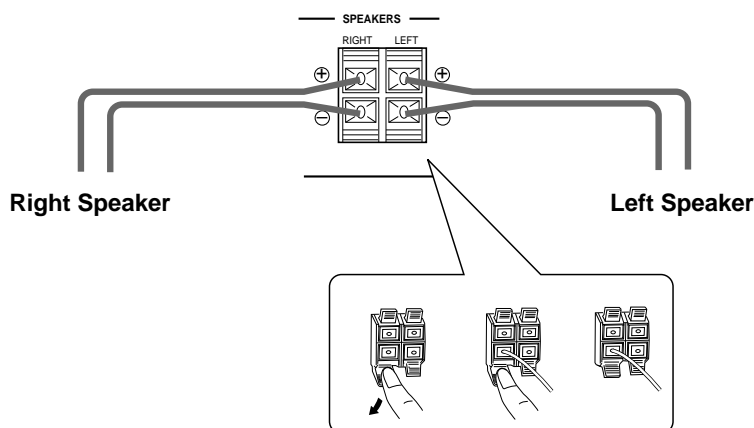

**IMPORTANT: Use speakers with the correct impedance only. The correct impedance is indicated on the back panel.**

**CAUTION: If a TV is installed near speakers, the TV may display irregular colours. In this case, set the speakers away from the TV.**

### For CA-D451TR or CA-D351TR

For each speaker, connect one end of the speaker wire to the speaker terminals on the back of the System.

1. Open each of the terminals and insert the speaker wires firmly, then close the terminals.
2. Connect the red (+) and black (-) terminals of the right side speaker to the red (+) and black (-) terminals marked RIGHT on the System.  
Connect the red (+) and black (-) terminals of the left side speaker to the red (+) and black (-) terminals marked LEFT on the System.

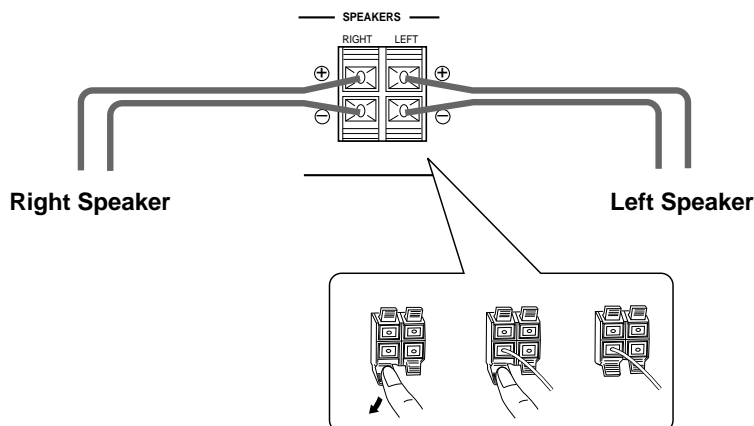

**IMPORTANT: Use speakers with the correct impedance only. The correct impedance is indicated on the back panel.**

**CAUTION: If a TV is installed near speakers, the TV may display irregular colours. In this case, set the speakers away from the TV.**

## Connecting Auxiliary Equipment

### VCR or other equipment

To listen to this source, press the AUX button.

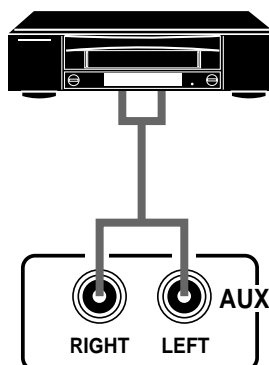

**Now you can plug the AC power cord into the wall outlet, and your System is at your command!**

## COMPU PLAY

COMPU PLAY is JVC's feature that lets you control the most frequently used functions of the System with a single touch.

One Touch Operation starts playing a CD, turns on the radio, plays a tape, etc. with a single press of the play button for that function. What One Touch Operation does for you is to turn the power on, then start the function you have specified. If the Unit is not ready, such as no CD or tape in place, the Unit still powers on so you can insert a CD or tape.

How One Touch Operation works in each case is explained in the section dealing with that function.

The COMPU PLAY buttons are:

### On the Unit

- CD ▷/|| button
- CD Player DISC-1 to DISC-3 buttons
- CD Player Open/Close (▲) buttons
- FM/AM button
- ◁ TAPE ▷ button
- AUX button

### On the Remote Control

- FM/AM button
- AUX button
- CD control ►/|| button
- CD control DISC 1 to DISC 3 buttons
- CD control Open/Close (▲) buttons
- Deck control ◀, ▶ buttons

# Common Operations

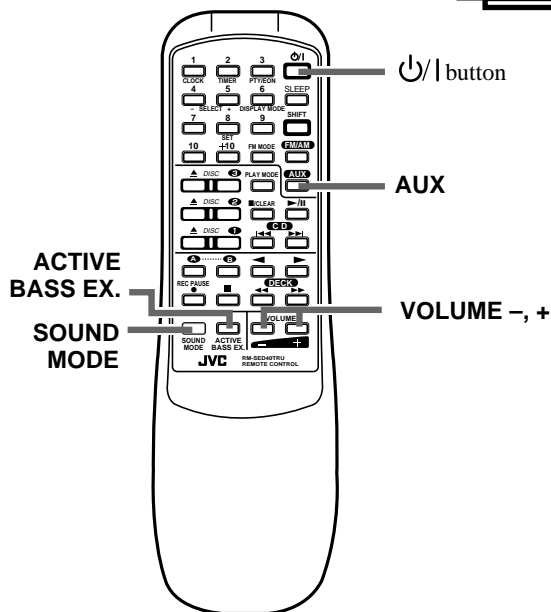
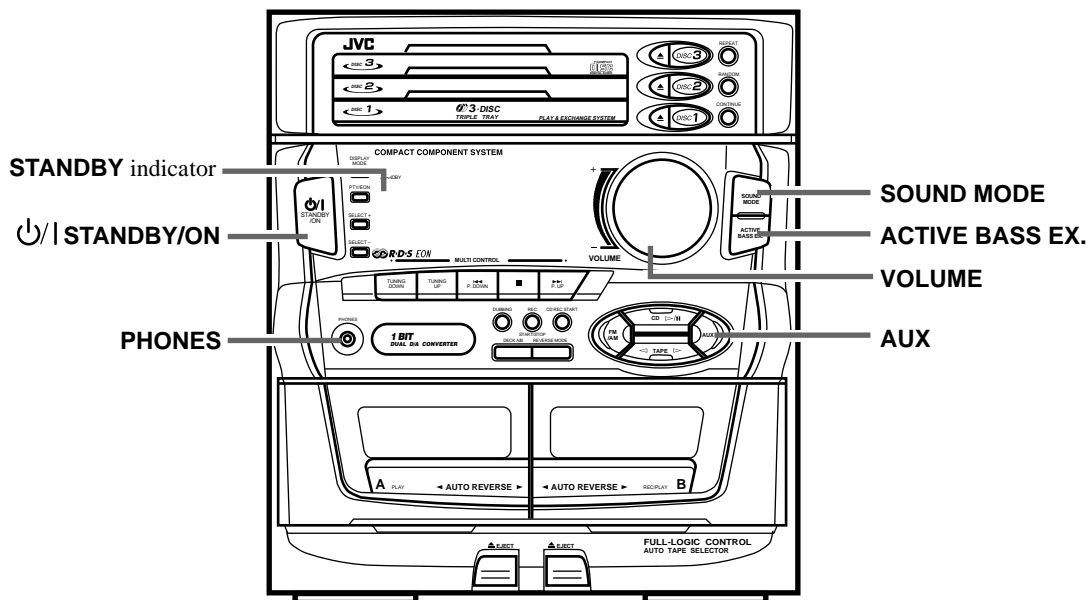

## Display

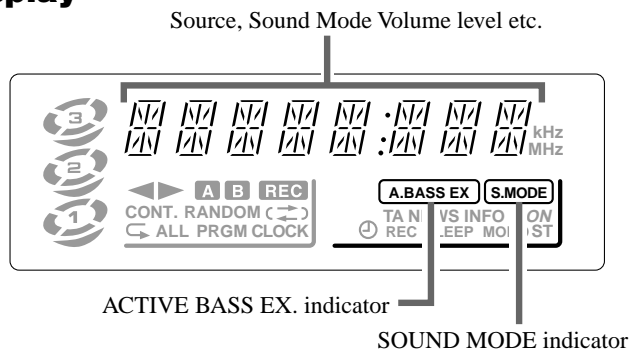

When the System is being used, the display shows other items as well. However, we have only shown the items described in this section.

## Turning the Power On and Off

### Turning the System On

Press the **STANDBY/ON** button.

The display comes on and the STANDBY indicator goes out.

The System comes on ready to continue in the mode it was in when the power was last turned off.

- If the last thing you were doing was listening to a tape in Deck B, you are now ready to listen to a tape again in Deck B, or you can change to another source.
- If you were listening to the Tuner last, the Tuner comes on playing the station it was last set to.

### Turning the System Off

Press the **STANDBY/ON** button again.

The STANDBY indicator lights up and the display is blank, except for the clock display.

- Some power (12 watts) is always consumed even though power is turned off (called Standby Mode).
- To switch off the Unit completely, unplug the AC power cord from the AC outlet. When you unplug the AC power cord, the clock will be reset to 0:00 immediately, and preset Tuner stations will be erased after a few days.

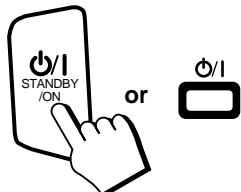

## Adjusting the Volume

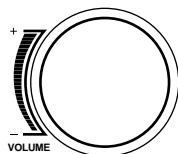

or



Turn the VOLUME control clockwise to increase the volume or anticlockwise to decrease it.

Turning the VOLUME control quickly also adjusts the volume level quickly.

When using the Remote Control, press the VOLUME + button to increase the volume or press the VOLUME – button to decrease it.

You can adjust the volume level between 0 and 50.

VOLUME 0

**CAUTION: The Volume cannot be adjusted while the Unit is in STANDBY mode. DO NOT turn on the Unit and/or start playing any source without setting the VOLUME control to 0; otherwise, the sudden blast of sound can damage your hearing, speakers and/or headphones.**

### For private listening

Connect a pair of headphones to the PHONES jack. No sound comes out of the speakers.

Be sure to turn down the volume before connecting or putting on headphones.

## Reinforcing the Bass Sound

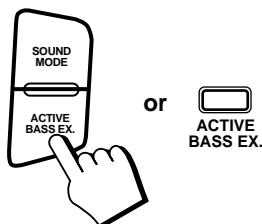

The richness and fullness of the bass sound is maintained regardless of how low you set the volume.

You can use this effect only for playback.

**To get the effect**, press the ACTIVE BASS EX. (Active Bass Extension) button.

The frame around the “A. BASS EX” indicator lights up.

A.BASS EX

**To cancel the effect**, press the button again.

The frame around the “A. BASS EX” indicator goes out.

A.BASS EX

## Sound Modes

The System has some preset sound effects that give you control of the way your music sounds, so you can tailor it for your room and for the quality of the source. We can give you some idea of how each one affects the music, but the only way to really tell is to try them yourself.

- The preset sound modes include modes using surround effects and modes using S.E.A. effects.
- Sound Mode effects cannot be recorded.

### Surround effect modes

- D. CLUB (Dance Club)** Increases resonance and bass.
- HALL** Adds depth and brilliance to the sound, like in a concert hall.
- STADIUM** Adds clarity and spreads the sound, like in an outdoor stadium.

### S.E.A. effect modes

- ROCK** Boosts low and high frequencies.
- CLASSIC** Set for wide and dynamic sound stereo systems.
- POP** Good for vocal music.

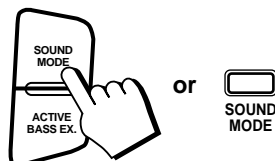

**To get an effect**, press the SOUND MODE button repeatedly until the Sound Mode you want appears in the display. The frame around the “S.MODE” indicator lights up.

Each time you press the SOUND MODE button, the display changes as shown below:

S.MODE

→ D. CLUB → HALL → STADIUM → ROCK → CLASSIC → POP → FLAT → (back to the beginning)

**To cancel an effect**, press the SOUND MODE button until “FLAT” appears on the display. The frame around the “S. MODE” indicator goes out.

S.MODE

**To recall the previous Sound Mode**, press the SOUND MODE button again.

# Listening to Auxiliary Equipment

By playing the sound from auxiliary equipment through the System, you can gain control over how the music or program sounds. Once the connected equipment is playing through the System, you can apply the sound effects.

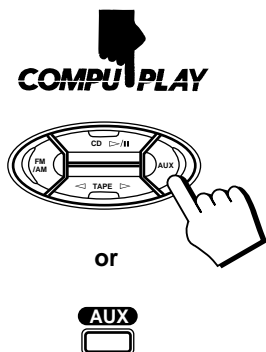

■ First make sure that the optional equipment is properly connected to the System. (See page 6).

## 1. Set the **VOLUME** control to 0.

## 2. Press the **AUX** button.

When System is in Standby mode, the Unit is automatically turned on and “AUX” appears on the display.

AUX

## 3. Start playing the equipment.

## 4. Adjust the **VOLUME** control to the desired listening level.

## 5. Select a sound effect mode, if you wish.

### To Cancel the Setting

Change the source by starting any one of the System’s built-in sound sources, such as the Tuner or CD Player.

# Using the Tuner

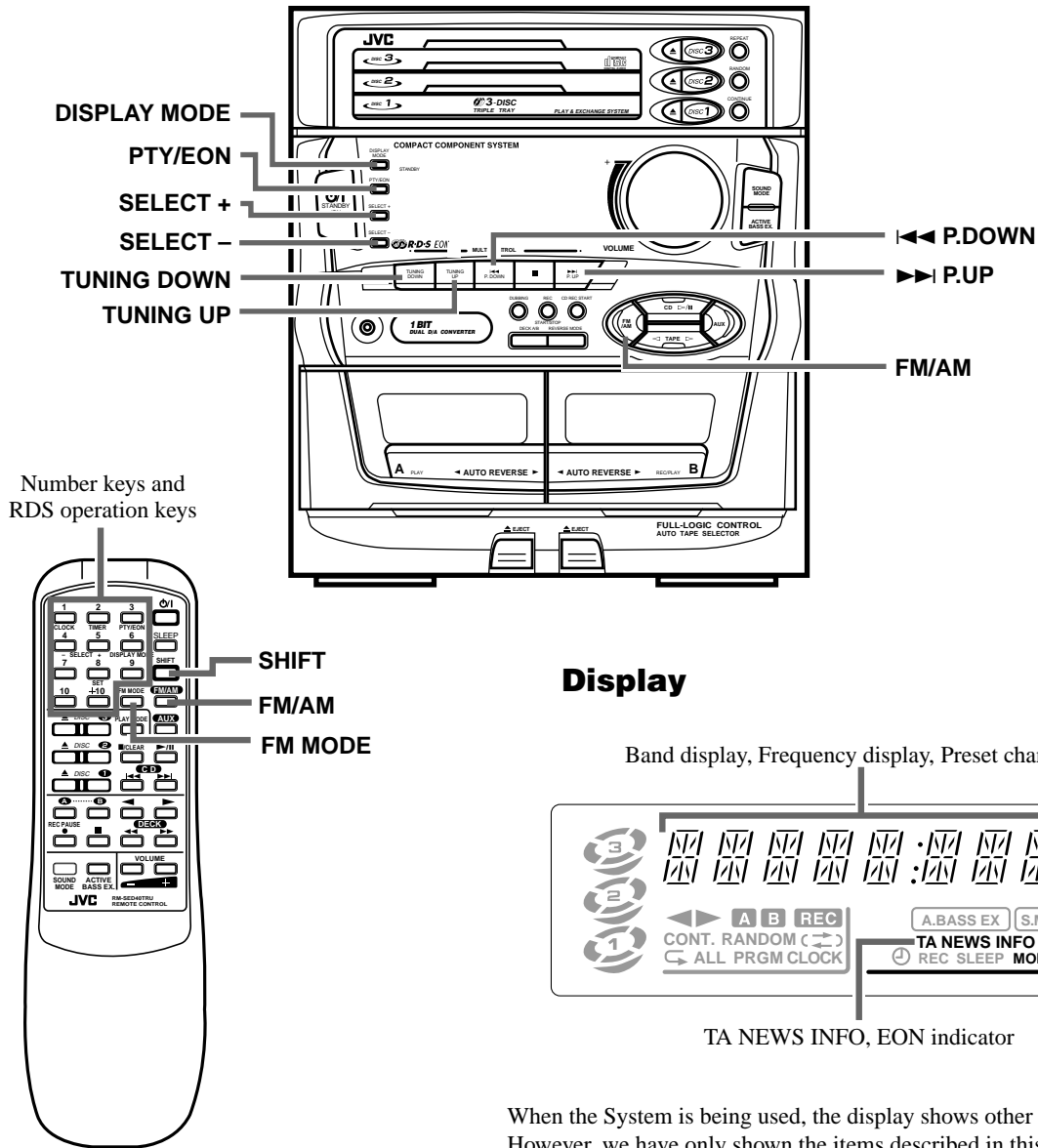

When the System is being used, the display shows other items as well. However, we have only shown the items described in this section.

You can listen to both FM and AM (MW/LW) stations. Stations can be tuned in manually, automatically, or from preset memory storage.

■ Before listening to the radio:

- Check that both the FM and AM (MW/LW) antennas are firmly connected. (See page 4).



## One Touch Radio

Just press the FM/AM button to turn on the Unit and start playing the most recent station tuned in.

- You can switch from any other sound source to the radio by pressing the FM/AM button.

## Tuning In a Station

Press the FM/AM button to turn on the radio.

The Frequency of the previously selected channel appears on the display.

## Switching between Frequency Bands

**Press the FM/AM button.**

Each time you press the button, the band alternates between FM and AM (MW/LW).

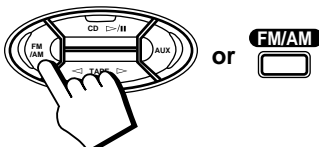

## Three ways to select a station

- Press the TUNING DOWN or TUNING UP button repeatedly to move from frequency to frequency until you find the one you want. (Manual Tuning).  
OR
- Press and hold the TUNING DOWN or TUNING UP button for a few seconds, the frequency starts changing on the display. When a station is tuned in, the frequency stops changing. (Auto Tuning).  
OR
- Possible only after presetting stations.

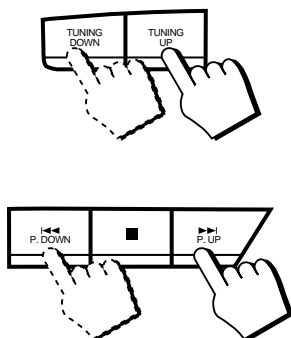

Press once and release the ◀◀ P. DOWN or ▶▶ P. UP button to go to the next preset station, or hold the ◀◀ P. DOWN or ▶▶ P. UP button to cycle through the preset stations: release the button when the preset station you want shows on the display.

### You can also use the Remote Control to tune in preset channels:

1. Press the FM/AM button so that you can receive the most recent station tuned in.
2. Select the station by entering the preset number in the number keys of the Remote Control.
  - Example: for channel 5, press 5. For channel 15, press +10 then 5. For channel 20, press +10, then 10. For channel 30, press +10 twice then 10.

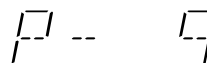

- After you have selected the preset number and the number is displayed, the broadcast frequency of the selected channel is displayed.

## Presetting Stations

You can preset up to 30 FM stations and up to 15 AM stations for the preset numbers.

**Note:** In some cases, test frequencies have been already memorized for the tuner since the factory examined the tuner preset function before shipment. This is not a malfunction. You can preset the stations you want into memory by following the presetting method.

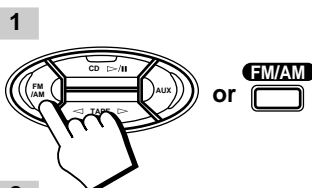

1. Select a band by pressing either the FM/AM button.

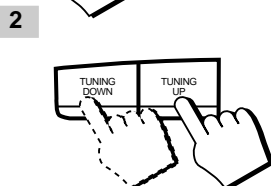

2. Press the TUNING DOWN or TUNING UP button to tune into a station.

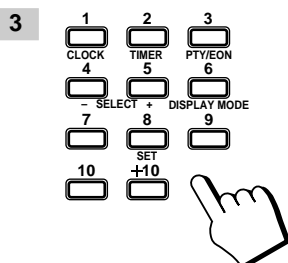

3. Setting the preset number by pressing the number keys on the Remote Control continuously.

**For preset numbers 1 to 10:**

Press the number key for the preset number you want to set.

**For preset numbers 11 to 20:**

Press the 1 to 10 buttons after pressing the +10 button.

**For preset numbers 21 to 30:**

Press the 1 to 10 buttons after pressing the +10 button twice.

The preset number appears in the display after you have pressed the number keys. If the key is pressed continuously, the preset number display blinks. Release the button after the number starts to blink. This completes the preset setting.

4. Repeat steps 1 - 3 for each station you want to store in memory with a preset number.

**CAUTION:** If the Unit is unplugged or if a power failure occurs, the preset stations will be erased after a few days. If this happens, preset the station again.

## To Change the FM Reception Mode



When an FM stereo broadcast is hard to receive or noisy, press the FM MODE button on the Remote Control so that the "MONO" indicator lights up in the display. Reception improves, but there is no stereo effect.

**To restore the stereo effect,** press the FM MODE button on the Remote Control so that the "MONO" indicator goes off. In this stereo mode, the "ST" indicator lights up and you can hear stereo effects, when a program is broadcast in stereo.

# Receiving FM Stations with RDS



RDS (Radio Data System) is a broadcasting service which a growing number of FM stations are now providing. It allows the FM stations to send additional signals along with their regular programme signals. For example, the stations send their station names and information about what type of programme they broadcast, such as sports or music, etc.

When tuned to an FM station which provides the RDS service, the station frequency (and then the station name if sent) is displayed.

One convenient RDS service is "Enhanced Other Networks (EON)". This allows the Unit to automatically switch to a programme type of your choice when one starts in your broadcast area.

■ Not all FM stations provide RDS service, nor do all RDS stations provide the same services. If in doubt, check with local radio stations for details on RDS services in your area.

**Note:** RDS may not work correctly if the station to which you are tuned is not transmitting properly or if the signal strength is weak.

## What Information RDS can Provide

The System can use the following RDS service.

### PS (Program Service name)

Identifies each station by a name.

### TA (Traffic Announcement Identification)

Identifies that a traffic announcement is being broadcast in your area.

### RT (Radio Text)

Allows the RDS station to send text messages that appear on the display of the unit.

### PTY (Programme Type)

Identifies the type of RDS programme. This allows you to locate a specific type of programme being broadcast.

The programme types are as follows:

<b>TRAFFIC:</b>	Traffic announcement
<b>NEWS:</b>	News
<b>AFFAIRS:</b>	Topical programme expanding on current news or affairs
<b>INFO:</b>	Programmes on medical service, weather forecast, etc.
<b>SPORT:</b>	Sports events
<b>EDUCATE:</b>	Educational programmes
<b>DRAMA:</b>	Radio plays
<b>CULTURE:</b>	Programmes on national or regional culture
<b>SCIENCE:</b>	Programmes on natural sciences and technology
<b>VARIED:</b>	Other programmes like comedies or ceremonies
<b>POP M:</b>	Pop music
<b>ROCK M:</b>	Rock music
<b>M.O.R. M:</b>	Middle-of-the-road music (usually called "easy listening")
<b>LIGHT M:</b>	Light music
<b>CLASSICS:</b>	Classics
<b>OTHER M:</b>	Other music
<b>NONE:</b>	Undefined
<b>ALARM:</b>	Emergency broadcasts

### EON (Enhanced Other Networks)

Provides information available on RDS stations other than the one which is being received.



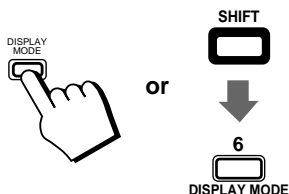

## Changing the Display

You can see RDS information on the display.

To view RDS information on the display, press the DISPLAY MODE button. (When using the Remote Control, press the 6 DISPLAY MODE button after pressing the SHIFT button.)

Each time you press the button, the display changes to show the following information:

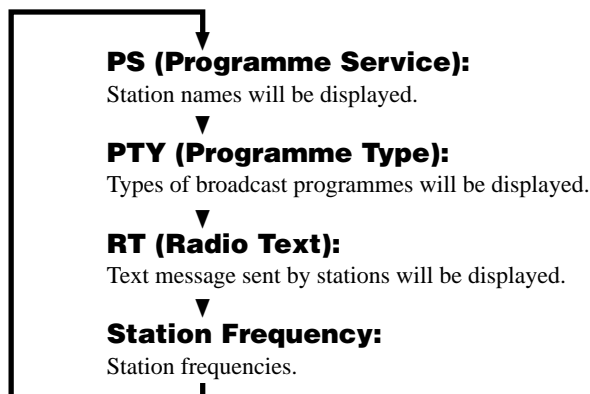

- While RDS information is being received from a station, “PS”, “PTY”, or “RT” may appear on the display.

## Searching for Programmes by PTY codes

One of the advantages of the RDS service is that you can locate a particular kind of programme by specifying the PTY codes.

- The PTY Search function is applicable to preset stations only.

**To search for a programme using the PTY codes, follow this procedure:**

### 1. Press the PTY/EON button once.

- When using the Remote Control, press the 3 PTY/EON button after pressing the SHIFT button. “PTY” and “SELECT” appear alternately on the display.

**Note:** If no adjustments are made for 10 seconds in PTY Select mode, the display reverts to the previous display. Perform the next step while “PTY” and “SELECT” are being displayed.

### 2. Press the SELECT + or SELECT – button to select a PTY.

- When using the Remote Control, press the 5 SELECT + or 4 SELECT – button.

The display changes with each pressing the button as shown below:

SELECT + →  
 ↔ TRAFFIC ↔ NEWS ↔ AFFAIRS ↔ INFO ↔ SPORT ↔ EDUCATE ↔  
 DRAMA ↔ CULTURE ↔ SCIENCE ↔ VARIED ↔ POP M ↔ ROCK M ↔  
 M.O.R. M ↔ LIGHT M ↔ CLASSICS ↔ OTHER M ↔  
 ← SELECT –

### 3. Press the PTY/EON button again.

- When using the Remote Control, press the 8 SET button.

While the search function is running, the selected programme type and “SEARCH” alternate on the display.

Once the station which is broadcasting the selected PTY (Programme Type) is located, searching will stop. Then the station name (if PS code is being sent) will be indicated and the broadcast will commence. The Display will stay blinking for 10 seconds from the end of the searching function. If you press the PTY/EON button again during this period, search for the same PTY (Programme Type) will restart.

- If a station broadcasting a selected PTY (Programme Type) cannot be found, “NOTFOUND” is displayed alternately on the display after the Unit has searched through the preset numbers. The Unit will return to the station to which it was tuned prior to the start of the PTY Search.

**To cancel a PTY Search operation,** press the PTY/EON button. (When using the Remote Control, press the 3 PTY/EON button.)

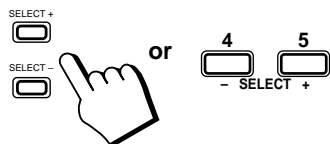
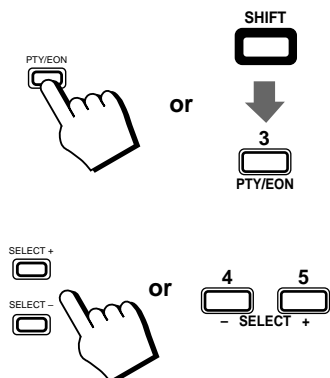

## EON Function

With the EON (Enhanced Other Networks) code, the Unit can perform a standby reception which will enable you to obtain desired information which is available from other stations.

- “EON” will be displayed while receiving stations with an EON code.
- EON Standby reception is applicable for preset stations only.
- You can set EON Standby reception regardless of types of receiving bands.

### Setting EON Standby reception

#### 1. Press the PTY/EON button twice.

- When using the Remote Control, press the 3 PTY/EON button after pressing the SHIFT button then press the 8 SET button.  
The last EON information type selected is displayed.

#### 2. Select information you want by pressing the SELECT + or SELECT - button.

- When using the Remote Control, press the 5 SELECT + or 4 SELECT - button.
- TA:** Identifies that a traffic announcement is being broadcast in your area.  
**NEWS:** News  
**INFO:** Programmes on medical service, weather forecast, etc.
- With each pressing of the button, indications will change as follows:

SELECT + →  
 ↔ TA ↔ NEWS ↔ INFO ↔ OFF ↔  
 ← SELECT -

#### 3. Press the PTY/EON button.

- When using the Remote Control, press the 8 SET button.  
As soon as your selection is entered the Unit will go into EON Standby reception mode.

If you want to cancel the EON function, select “OFF” by following the steps above.

**When this Unit carries out EON Standby reception, the indication will change as follows:**

1. Waiting for EON Standby reception.

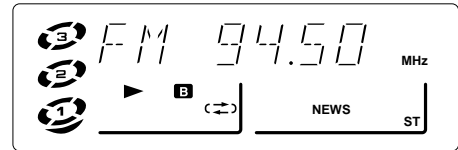

2. Preset stations are being searched for and while preparing to change the station, sound will be muted.

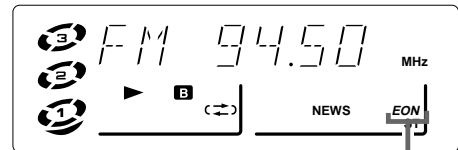

Light up

3. The station will be changed and the Station name being received will appear on the display.

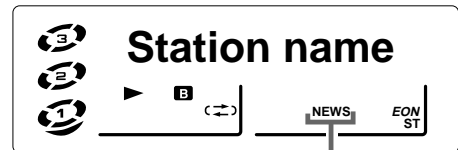

Blinking

- When using the DISPLAY MODE button to change the display, use the appropriate setting for the type of display.

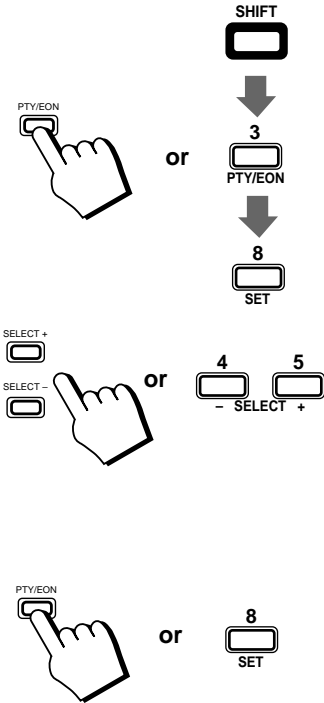

**Notes:**

- EON broadcasts of some stations may not be compatible with this Unit. In the case of an incompatible EON broadcast, “EON” will not appear on the display.
- While the Unit is receiving information for an EON code you have selected for EON Standby, you cannot use the following operations: ◀◀ P. DOWN or ▶▶ P. UP button. In addition, if a station transmits information for a programme type you have selected without sending the EON code, the EON Standby operation is still performed. Therefore, you will not be able to use the operations listed above during this period.
- If the reception is unsatisfactory for a station among the preset stations, the station is searched for again. If after searching through the channels, the broadcasting station cannot be found, “NOTFOUND” is displayed alternately on the display. The Unit will return to the station to which it was previously tuned.

When broadcasting of the desired information has been completed, the Unit will automatically go back to the station which had previously been tuned to.

- While receiving information on EON Standby reception, the station will not change to other stations even if the same information is available from them.
- If you cancel the EON function when in EON Standby reception mode, the Unit will automatically return to the station which had been previously tuned-in.

If the information you are waiting for is available from the current station, the indicator will blink.

**ALARM function** 

---

If an ALARM (Emergency) signal is received while receiving an EON code from a station, the Unit automatically switches to the station broadcasting the ALARM signal.

# Using the CD Player

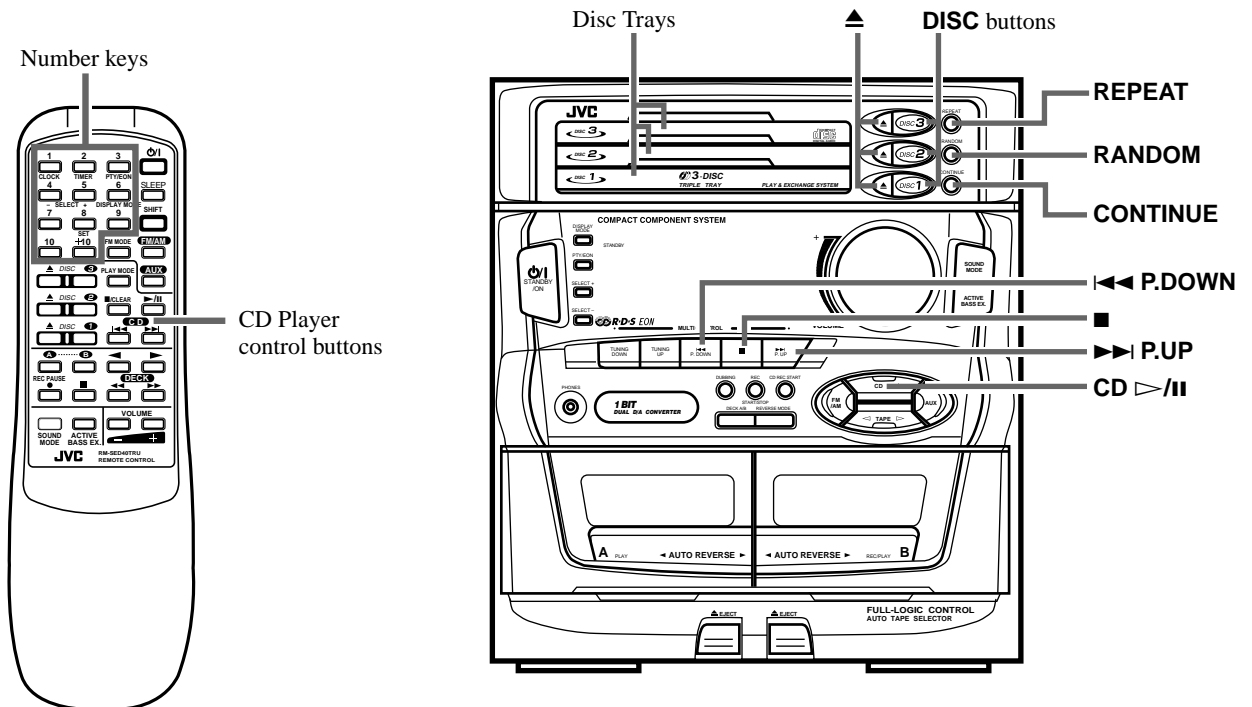

## Display

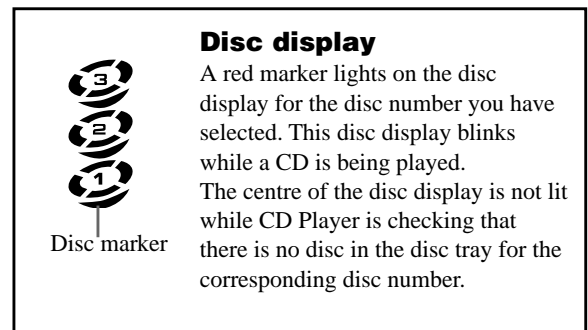
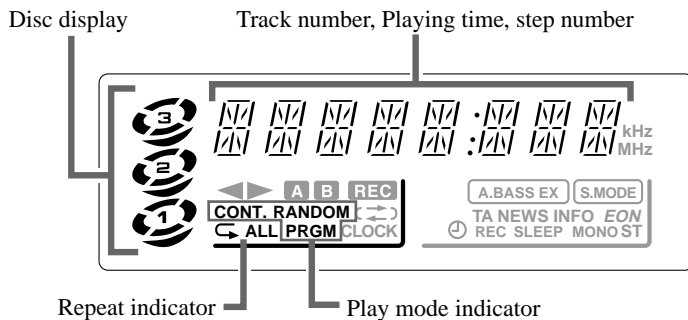

### Disc display

A red marker lights on the disc display for the disc number you have selected. This disc display blinks while a CD is being played. The centre of the disc display is not lit while CD Player is checking that there is no disc in the disc tray for the corresponding disc number.

When the System is being used, the display shows other items as well. However, we have only shown the items described in this section.

The System's CD Player has an Automatic Changer with 3 disc trays. You can use Continuous, Random, Program or Repeat Play for the discs in DISC-1, DISC-2 and DISC-3. Repeat Play can repeat all the tracks on all the CD's, the tracks on one of the CD's or one track on one CD. There is also the Tray Lock function, which safely keeps discs in the trays.

Here are the basic things you need to know to play a CD and locate the different selections on it. Each selection is called a track, so when we are talking about locating a track, we are also talking about how you find a certain song or performance.

## The Quickest Way To Start a CD Is With the One Touch Operation

■ Press the CD /|| button (or the /|| button on the Remote Control).

### For Normal Play (Play mode indicator is not lit):

- If there is a CD in the disc tray for the selected disc number, the power is automatically turned on and the CD is played from the first track.
- If there is no CD in the disc tray for the selected disc number, the power is automatically turned on and “NO DISC” appears on the display. The CD Player is in stop mode.

### For Continuous Play or Random Play in Display mode (CONT. or RANDOM indicator is lit):

- If there is a CD in the disc tray for the selected disc number, the power is automatically turned on and the CD is played continuously from the first track or the tracks are played in random order.
- If there is no CD in the disc tray for the selected disc number, the power is automatically turned on and other tray containing a CD is selected and is played continuously from the first track or the tracks are played in random order.
- If there are no CDs in CD player, the power is automatically turned on and “NO DISC” appears on the display in Normal Play mode. The CD Player is in stop mode.

■ Press a DISC button (1 to 3).

- If there is a CD in the disc tray for the selected disc number, the power is automatically turned on and playback starts from the selected CD.
- If there are no CDs in CD Player, the power is automatically turned on and “NO DISC” appears on the display in Normal Play mode. The CD Player is set to stop mode.

■ Press the button.

- The power turns on, and the tray opens automatically.

## To Insert Discs

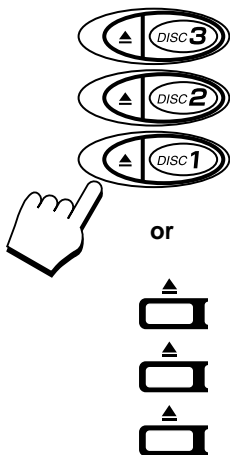

**1. Press the button on the left of the Disc button you want to insert the disc into.**

The disc tray slides out automatically.

**2. Place a CD, with its label side up, onto the tray.**

**ATTENTION:** To avoid malfunctions when you play a CD, please set the CD in the right place at the centre of the tray.

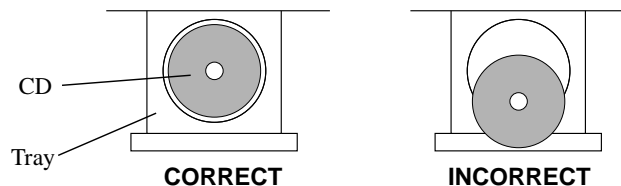

**3. Press the button to close the tray.**

**4. Repeat steps 1 to 3 to insert other discs into other trays.**

- To continue putting discs into other trays, even if a tray is open, by pressing the button of another disc tray, the open tray will close automatically, and the new disc tray will slide out.

■ To put an 8 cm CD into a tray, insert it so that it is aligned with the groove in the tray’s centre.

■ If a tray is open when the System switches to Standby mode, the tray is closed automatically.

■ If the CD cannot be read correctly (due to scratches etc.), “00 00000” appears on the display.

# Basics of Using the CD Player — Normal Play

## To Play a Disc

### 1. Prepare the discs.

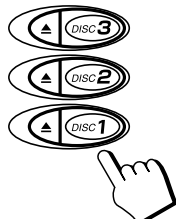
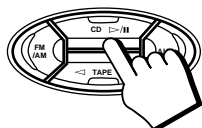

### 2. Press the CD ▷/|| or DISC button (1-3) of the disc you want to play.

When using the Remote Control, press the ►/|| button or the DISC (1 to 3) buttons.

The first track of the selected disc will begin playing.

The CD Player automatically stops when the playback finishes the last track of the CD.

- If these buttons are pressed while the tray is open, the tray is automatically closed and playback starts.

**To stop play the disc,** press the ■ button (or the ■/CLEAR button on the Remote Control).

**To stop play and remove the disc,** press the ▲ button for the disc being played.

**To pause,** press the CD ▷/|| button (or the ►/|| button on the Remote Control).

**To cancel pause,** press the CD ▷/|| button again (or press the ►/|| button on the Remote Control). Play continues from the point where it was paused.

## To Select a Disc, Track Or Passage Within a Track

### 1. Press the DISC button (1-3) for the disc tray containing the track you want to listen to.

- Example: for the third disc, press 3.

### 2. Press the ◀◀ P.DOWN or ▶▶ P.UP button to select the track.

The selected track starts playing.

Each time you briefly press and release the ◀◀ P.DOWN or ▶▶ P.UP button, the track changes by one.

- Press and release the ▶▶ P.UP button to go ahead one track at a time.
- Press and release the ◀◀ P.DOWN button to go back one track at a time.

Holding down the ◀◀ P.DOWN or ▶▶ P.UP button, during playback, will fast forward/backwards the CD so you can quickly find a particular passage in the selection you are listening to.

When using the Remote Control, press the ◀◀ or ▶▶ button.

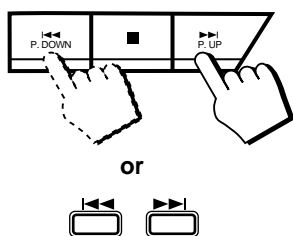

or

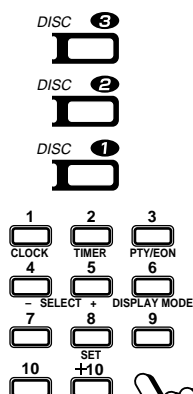

## Locating a Track With the Remote Control Directly

Using the number keys on the Remote Control allows you to go directly to the beginning of any track.

### 1. Press the DISC button (1-3) for the disc tray containing the track you want to listen to.

- Example: for the third disc, press 3.

### 2. Enter the number of the track you want to listen to with the number keys.

The selected track starts playing.

- Example: for track 5, press 5. For track 15, press +10 then 5. For track 20, press +10, then 10. For track 32, press +10 three times, then 2.

## To Change Discs While Playing

You can replace a CD in a tray not being used, while another CD is playing.

### 1. Press the ▲ button of the tray not being used.

The tray opens.

### 2. Replace the disc in the tray.

### 3. Press the ▲ button to close the tray.

## Continuous Play

This function plays the disc in the Unit continuously.



### 1. Prepare the discs.

### 2. Select Continuous mode.

#### On the Unit

##### Press the **CONTINUE** button.

The playback automatically starts from the selected CD.

- “CONT.” on the Play mode indicator lights up.

You can press the CONTINUE button while a CD is playing to switch to Continuous mode.

#### On the Remote Control

##### 1. Press the **PLAY MODE** button while the **CD Player is stopped**, to select “CONTINUE”.

- “CONT.” lights in the Play mode indicator. The display changes with each press of the PLAY MODE button as shown below.



→ PROGRAM → RANDOM → CONTINUE → No display → (back to the beginning)

##### 2. Press the **DISC** button (1 to 3) or **▶/||** button.

Playback starts from the selected CD.

#### Playing order of the CDs

The selected CDs are played continuously in the following order.

→ DISC 1 → DISC 2 → DISC 3 → (back to the beginning)

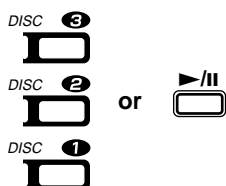

To cancel Continuous play, press the CONTINUE button again. The “CONT.” indicator on the display goes out and Normal Play is resumed. When using the Remote Control, press the PLAY MODE button while the CD Player is stopped to select a different Play mode. The “CONT.” indicator goes out and the next Play mode is selected.

## Programming the Playing Order of the Tracks

You can change the order in which the discs and tracks play, and select only the discs and tracks you want from among those loaded in the CD Player.

- You can program up to 20 steps in any desired order from among the discs in the player.
- You can only make a program when the CD Player is stopped.
- Use the Remote Control.



### 1. Press the **PLAY MODE** button to select “PROGRAM”.

The display changes with each press of the PLAY MODE button as shown below.

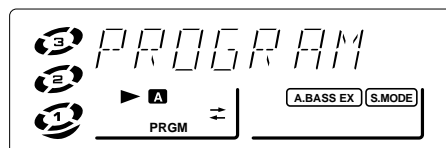

→ PROGRAM → RANDOM → CONTINUE → No display → (back to the beginning)

- The “PRGM” play mode indicator light up.
- If a program is already in progress, the last step of the program is displayed.

### 2. Select a disc with the **DISC** buttons (1-3).

The display changes to the Program Entry display.

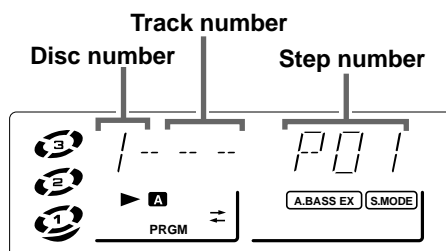

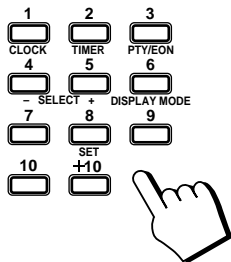

### 3. Press the number keys (1 to 10 and +10) to select the track to program.

- Example: for track 5, press 5. For track 15, press +10 then 5. For track 20, press +10 then 10.

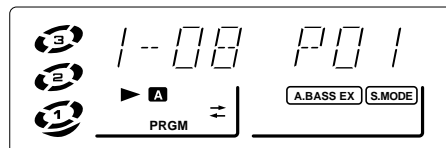

### 4. Repeat steps 1 to 3 to select the other tracks for the program.

### 5. Press the ►/|| button.

The Unit plays the tracks in the order you have programmed them.

- If you try to program a disc tray that is empty, or a track number that does not exist on a disc (for example, selecting track 14 on a disc that only has 12 tracks), the selected disc or track are skipped when the program is played.
- You can skip to a particular program step by pressing the ◀◀ or ▶▶ button during program play.
- To play the programmed tracks over and over, press the REPEAT button. The Repeat mode indicators light up in sequence with each press of the REPEAT button.

**To stop playing**, press the ■ button (or the ■/CLEAR button on the Remote Control) once.

**To delete all the tracks in a program**, press the ■ button on the Unit or the ■/CLEAR button on the Remote Control while the CD Player is stopped. The program is deleted and the “PRGM” play mode indicator goes out and Normal Play is resumed.

**To cancel program play**, press the PLAY MODE button on the Remote Control while the CD Player is stopped to select a different Play mode. The “PRGM” indicator goes out and the next Play mode is selected.

**Note:** If you press the CONTINUE or RANDOM button on the unit while a program is playing, the play mode changes to that mode.

## Random Play

The tracks will play in no special order when you use this mode.

### On the Unit

#### Press the RANDOM button.

The playback automatically starts from the selected CD.

- “RANDOM” on the Play mode indicator lights up.

You can press the RANDOM button while a CD is playing to switch to Random play mode.

### On the Remote Control

#### 1. Press the PLAY MODE button while the CD Player is stopped, to select “RANDOM”.

- “RANDOM” lights in the Play mode indicator.

The display changes with each press of the PLAY MODE button as shown below.

→ PROGRAM → RANDOM → CONTINUE → No display → (back to the beginning)



#### 2. Press the ►/|| button.

Playback starts from the selected CD.

**Note:** Random Play cannot be activated with the DISC button (1 to 3).

**To skip to the next track**, press the ▶▶ button during playback. The next track is jumped to with each press of the button. Press the ◀◀ button to jump to the start of the track being played.

- Press the REPEAT button before or during random play to instruct the System to continue with a different random track selection after the last selection is played.

**To cancel random play**, press the RANDOM button again. The “RANDOM” play mode indicator goes out and Normal Play is resumed. When using the Remote Control, press the PLAY MODE button while the CD Player is stopped to select a different Play mode. The “RANDOM” indicator goes out and the next Play mode is selected.





## Repeating a Selection or the Discs

You can have all the discs, the program or the individual selection currently playing repeat as many times as you like.



### Press the REPEAT button.

The display changes with each press of the button, as shown below.

→ → ALL → blank display → (back to the beginning)

- : Repeats one track on a CD.
- ALL: For Normal Play, repeats all the tracks on the current CD.  
For Continuous Play or Random Play, repeats all the tracks on all the CDs in the CD Player.  
For Program Play, repeats all the tracks in the program.

To exit Repeat Mode, press the REPEAT button until the Repeat mode indicator on the display goes out.

## Tray Lock Function

In order to safely keep the discs in the CD Player, the three trays can be electronically locked in a single operation.

When the electronic lock is on, the trays cannot be opened even if the button is pressed.

This function can only be accessed by using the buttons on the Unit itself.

### Locking the Electronic Lock

1. Put the System's power into STANDBY mode.
2. While pressing the button, press the button for DISC 1's tray on the Unit.

"LOCK ON" appears on the display to let you know that the trays have been locked.

LOCK ON

When the CD Player trays are locked, pressing the buttons displays the message "LOCK ON" on the display and the trays do not open. Also, the button cannot be used to automatically turn on the power.

### Unlocking the Electronic Lock

1. Put the System's power into STANDBY mode.
2. While pressing the button, press the button for DISC 1's tray on the Unit.

When the unlock operation is done, "LOCK OFF" appears in the display to show that the lock has been taken off.

LOCK OFF

The trays can now be opened by pressing the buttons.

The button can also be used to automatically turn on the power.

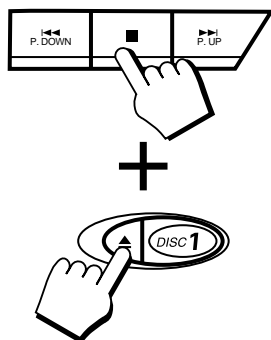

# Using the Cassette Deck (Listening to a Tape)

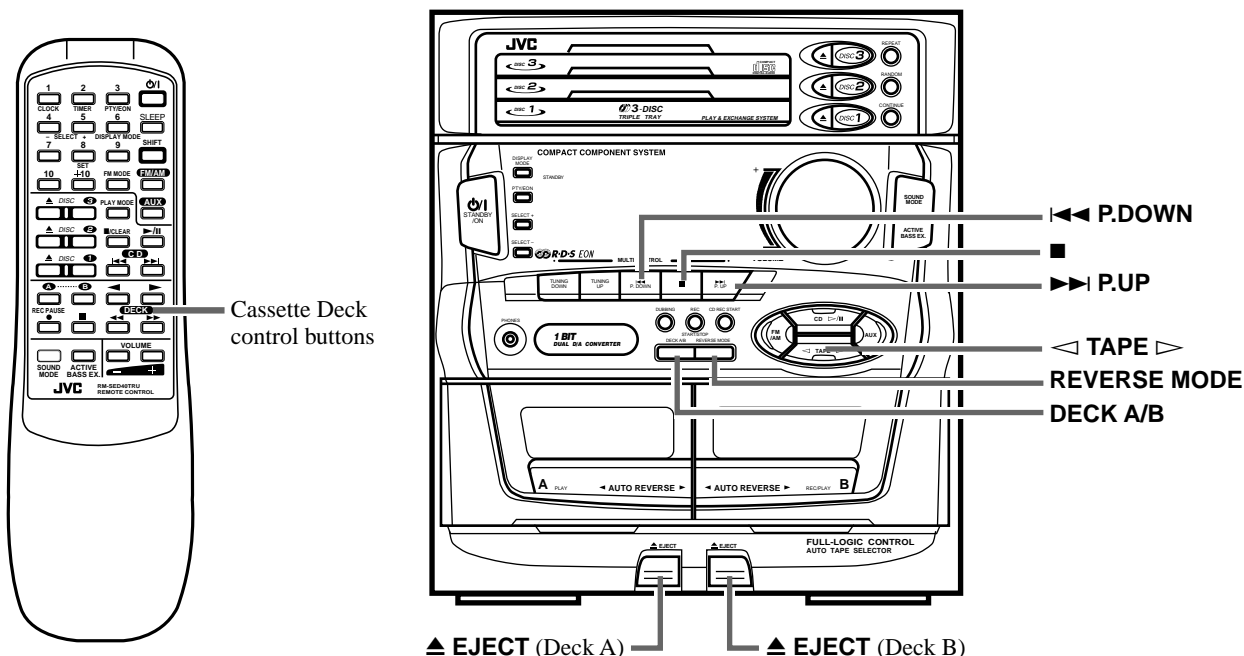

## Display

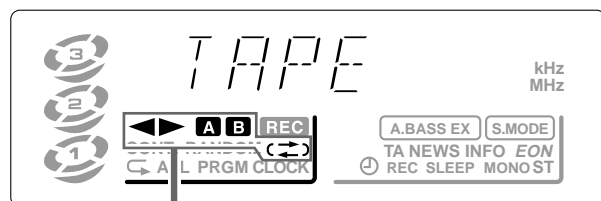

- ◀▶ : Tape Direction indicator  
**A B** : DECK A, B indicator  
 (↔) : Reverse Mode indicator

### Tape Direction Indicator on the Display

The Tape Direction indicator tells you which direction the selected tape deck will use for playback.

During playback, the direction indicator blinks slowly.

During fast left or fast right, the indicator blinks quickly.

During Music Scan mode, the direction indicator alternates between blinking slowly and quickly repeatedly.

When the System is being used, the display shows other items as well. However, we have only shown the items described in this section.

The Cassette Deck allows you to play, record and dub audio tapes.

- With Automatic Tape Detection, you can listen to type I or II tapes without changing any settings.

The use of tapes longer than 120 minutes is not recommended, since characteristic deterioration may occur and these tapes easily jam in the pinch-rollers and the capstans.

## One Touch Play



By pressing the ◁ TAPE ▷ button (or the ◀ or ▶ button on the Remote Control), the Unit will come on, "TAPPE" appears in the display, and if a tape is in the deck, it will start to play. If no tape is loaded, the Unit will come on and wait for you to insert a tape, or select another function.

## Regular Play

When the power is already on, you can use this basic procedure:

1. Press the ▲ EJECT button for the deck you want to use.
2. When the cassette holder opens, put the cassette in, with the exposed part of the tape down, toward the base of the System.
  - If the cassette holder does not open, turn the Unit off, then back on and press the ▲ EJECT button again.

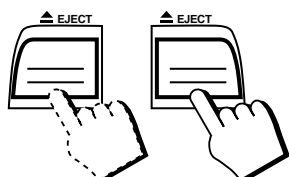

**3. Close the holder gently.**

When both Deck A and Deck B contain a tape, the last deck to have a tape inserted is selected. To change the selected deck, press the DECK A/B button. When using the Remote Control, press the A or B button.

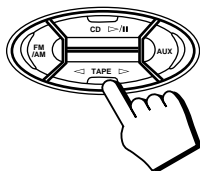
**4. Press the ◁ TAPE ▷ button (or ◀ or ▶ button on the Remote Control).**

The tape is played in the direction of the button pressed for the selected deck.

- The Cassette Deck automatically stops when one side of a tape has finished playing.

To stop playing, press the ■ button.

To remove the tape, stop the tape, and press the ▲ EJECT button.

To change deck while playing a tape, press the ◁ TAPE ▷ button after pressing the DECK A/B button on the Unit or press the ◀ or ▶ button after pressing the A or B button on the Remote Control.

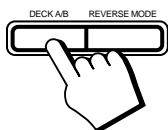
**Fast Left And Fast Right**

■ While the tape is stopped, press the ◀◀ P.DOWN button (or ◀◀ button on the Remote Control) and the tape will wind rapidly onto the left side of the cassette without playing.

■ While the tape is stopped, press the ▶▶ P.UP button (or ▶▶ button on the Remote Control) and the tape will wind rapidly onto the right side of the cassette without playing.

**Note:** Deck A and Deck B cannot be used for playback at the same time.

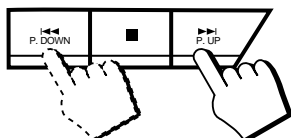
**Music Scan**

To find the beginning of a music track during play, use the Music Scan function. Music Scan searches for blank portions that usually separate selections, then plays the next selection.

**To Find the Beginning of the Current Selection**

**Press the ◀◀ P.DOWN or ▶▶ P.UP button (or the ◀◀ or ▶▶ button on the Remote Control) during play.**

■ Make sure that you press the ◀◀ P.DOWN or ▶▶ P.UP button (or the ◀◀ or ▶▶ button on the Remote Control) in the opposite direction to that in which the tape is playing. Searching stops at the beginning of the current selection, and the current selection starts automatically.

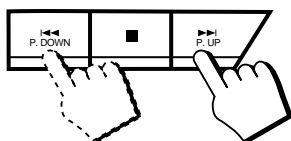
**To Find the Beginning of the Next Selection**

**Press the ◀◀ P.DOWN or ▶▶ P.UP button (or the ◀◀ or ▶▶ button on the Remote Control) during play.**

■ Make sure that you press the ◀◀ P.DOWN or ▶▶ P.UP button (or the ◀◀ or ▶▶ button on the Remote Control) in the same direction as that in which the tape is playing. Searching stops at the beginning of the next selection, and the next selection starts automatically.

**Music Scan works by detecting a 4-second long blank at the beginning of each selection, so it won't work well if your tape has:**

- No blank at the beginning of a selection .
- Noise (often caused by much use or poor quality dubbing) which fills the blank with noise.
- Long, very soft passages or pauses in a selection. The scan will detect these as 4-second long blanks. If this happens, just scan again until you reach the selection you want.

**Reverse Mode**

You can play both sides of a cassette, or play both the tapes in the two Cassette Decks continuously.

**Press the REVERSE MODE button to switch to Reverse Mode.**

The indicator changes with each press of the button as shown.

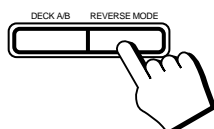

→ ⇄ → ⇄ → (⇄) → (back to the beginning)

⇄ : The Cassette Deck automatically stops after playing one side of the tape.

⇄) : The Cassette Deck automatically stops after playing both sides of the tape being played (or set to play).

(⇄) : After playing both sides of the tape being played (or set to play), the Unit always checks to see if a tape is in the other deck. If there is, it automatically starts playing that tape. This Continuous Play function works regardless of which deck starts first. The tapes are played continuously until the ■ button is pressed.

# Using the Cassette Deck (Recording)

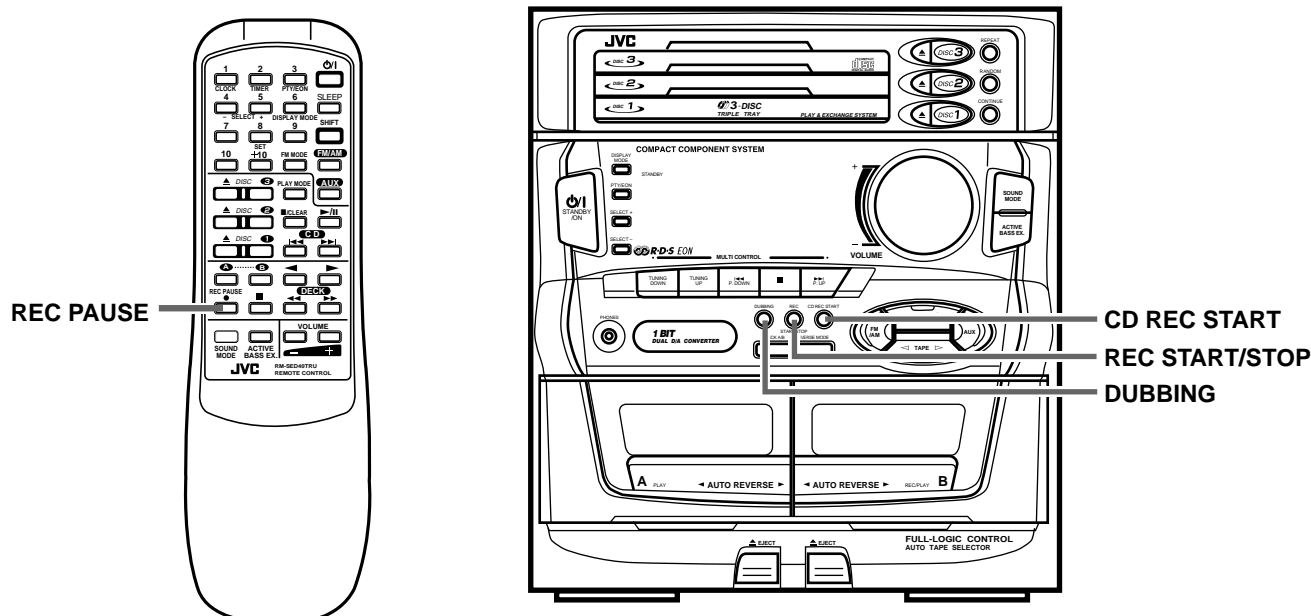

## Display

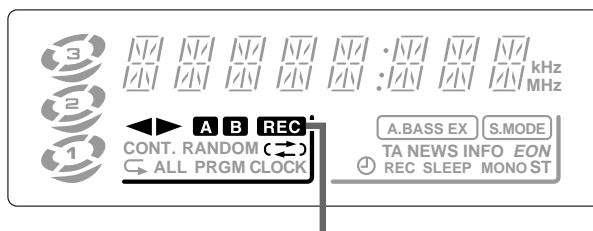

REC indicator

When the System is being used, the display shows other items as well. However, we have only shown the items described in this section.

Recording onto a cassette from any of the sound sources is simple. Just place a tape in Deck B, have the source ready, make one or two settings, and you're ready to record. For each source the procedure is a little bit different and now we'll explain just what to do for each one. If you forget, just come back to the section which has the specific procedures you need. But first, here are a few things to make your recordings better.

## Things To Know Before You Start Recording

- It may be unlawful to record or play back copyrighted material without the consent of the copyright owner.
- When you want to record onto both sides of a tape, you can set Reverse mode on to do so. However, recording automatically stops after recording in the ◀ direction in Reverse mode. Therefore, make sure that the tape direction is ▶ when recording with Reverse mode on.
- The recording level, which is the volume at which the new tape is being made, is automatically set correctly, so it is not affected by the VOLUME control on the System. Thus, during recording you can adjust the sound you are actually listening to without affecting the recording level.
- Two small tabs on the back of the cassette tape, one for side A and one for side B, can be removed to prevent accidental erasure or re-recording. To record on a cassette with the tabs removed, you must cover the holes with adhesive tape first. However, when a type II tape is used, only cover part of the hole as shown, since the other part of the hole is used to detect the tape type.
- When recording, you can hear Sound Mode effects through the speakers or headphones. However, the sound is recorded without Sound Mode effects.
- Type I and Type II tapes can be used for recording.

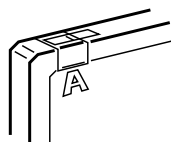

**Note:** At the start and end of cassette tapes, there is leader tape which cannot be recorded onto. Depending on the recording source, the first part of the recording may be missing because of the leader. When recording CDs or radio broadcasts, to get the beginning of the recording on the tape, first wind on the leader before beginning recording.

**CAUTION: If recordings you have made have excessive noise or static, the Unit may be too close to a TV which was on during the recording. Either turn off the TV or increase the distance between the TV and the System.**

## Standard Recording

This is the basic method for recording any source. The System also has special ways for recording CD to tape, and tape to tape, which save you time and effort, as well as give you some special effects. However, when you need to add a selection to a tape you have made, or are combining selections from several sources on one tape, use the method described below; just substitute the source you want into this procedure, such as a tape in Deck A, a CD, or the Tuner. You can also record from auxiliary source with this procedure.

### To Record Any Sound Source To Tape

Follow these steps to record from any sound source onto a tape in Deck B.

#### Using the Unit

##### 1. Insert a blank or erasable tape into Deck B.

##### 2. Press the REVERSE MODE button if you want to record on both sides of the tape.

Press the button until the “↔” or “↔” indicator is lit.

- When using Reverse Mode, insert the tape so that it will be recorded in the forwards ► direction.

##### 3. Check the recording direction for the tape.

Check that the Tape Direction indicator is the same as that for the tape in the tape deck. If the directions are different, press the ■ button after pressing the ◁ TAPE ▷ button to set the tape direction.

- When using Reverse Mode to record both sides of a tape, check that the Tape Direction indicator is in the forwards ► direction. If the direction indicator is not in the forwards ► direction, press the ◁ TAPE ▷ button then press the ■ button.

##### 4. Prepare the source, by, for example, tuning in a radio station, loading CDs, or turning on connected equipment.

##### 5. Press the REC START/STOP button.

The “REC” indicator light comes on and the System begins recording.



#### Using the Remote Control

##### 1. Insert a blank or erasable tape into Deck B.

##### 2. Press the REC PAUSE button.

The “REC” indicator blinks.

##### 3. Press the REVERSE MODE button on the Unit if you want to record on both sides of the tape.

Press the button until the “↔” or “↔” indicator is lit.

- When using Reverse Mode, insert the tape so that it will be recorded in the forwards ► direction.

##### 4. Prepare the source by, for example, tuning in a radio station, loading CDs, or turning on connected equipment.

##### 5. Press the ◁ or ► button.

Recording starts in the direction of the button pressed.

- When using Reverse Mode to record both sides of a tape, press the ► button.



#### Notes for using Reverse Mode for recording

When recording in Reverse Mode, the System automatically stops when it reaches the end of the reverse ◀ direction. To record on both sides of a tape, make sure that the recording direction for the tape inserted into Deck B is forwards ►, and that the Tape Direction indicator is also forwards ►, before you start recording.

### To Pause at Any Time During the Recording Process

Press the REC PAUSE button on the Remote Control. Then press either the ◀ or ▶ button on the Remote Control or REC START/STOP button on the Unit to restart recording.

### To Stop at Any Time During the Recording Process

Press the REC START/STOP button on the Unit again, or press the ■ button.



### Recording AM (MW/LW) station to tape

When recording an AM (MW/LW) broadcast, beats may be produced which are not heard when listening to the broadcast. In this case, press the CONTINUE button on the CD Player to eliminate the beats.

1. Set to AM (MW/LW) station and start recording.
2. Press the CONTINUE button to eliminate the beats.

Each time you press the button, the display changes as shown below:

→ CUT 2 → CUT 3 → CUT 4 → CUT 1 → (back to the beginning)

## CD Direct Recording

Everything on the CD goes onto the tape in the order it is on the CD, or according to the order you have set in a program.

### 1. Prepare CDs. (See page 17.)

Check that the CD Player is not playing a CD.

### 2. Insert a cassette in Deck B to record on.

- When you want to record on both sides of a tape, press the REVERSE MODE to turn Reverse Mode on. Check that the recording direction for the tape and the Tape Direction indicator are correct. (See page 25 “Notes for using Reverse Mode for recording”.)



### 3. Press the CD REC START button.

The “REC” indicator light comes on and the System begins recording.

If you make a recording with Reverse Mode on, the Unit will record the last song at the end of the first side at the beginning of the next side.

To stop at any time during the recording process, press the ■ button.

**Note:** When making SLEEP timer settings while doing CD Direct recording, set the time so that there is enough leeway to finish the recording before the power goes off. If the time is set to about the length of the CD, the power may go off before recording finishes.

For CD Direct Recording using more than one disc, use a blank tape. If you use a prerecorded tape, prerecorded material may not be erased between newly-recorded tracks.

## Tape to Tape Recording (Dubbing)

Recording from one tape to another is called dubbing.

You can dub tapes simply, with just a single button.

- When dubbing tapes, make sure that the playback direction of Deck A and Deck B are the same.
- When you want to record both sides of a tape, press the REVERSE MODE button to turn Reverse mode on.
- It is preferable that the type of tape (Type I or Type II) you record from be the same as the type you record onto.

### How to Use the DUBBING Button

#### 1. Insert the source cassette you want to copy from into Deck A for playback.

Insert the cassette so that it will be played in the forwards ▶ direction.

#### 2. Insert the blank or erasable cassette you want to copy onto in to Deck B for recording.

Insert the cassette so that it will be recorded in the forwards ▶ direction.

#### 3. Press the DUBBING button.

Deck A and Deck B will start simultaneously.



To stop dubbing, press the ■ button or REC START/STOP button.

- When doing dubbing with the DUBBING button, you can hear Sound Mode effects through the speakers or headphones. However, the sound is dubbed without Sound Mode effects.

# Using the Timer

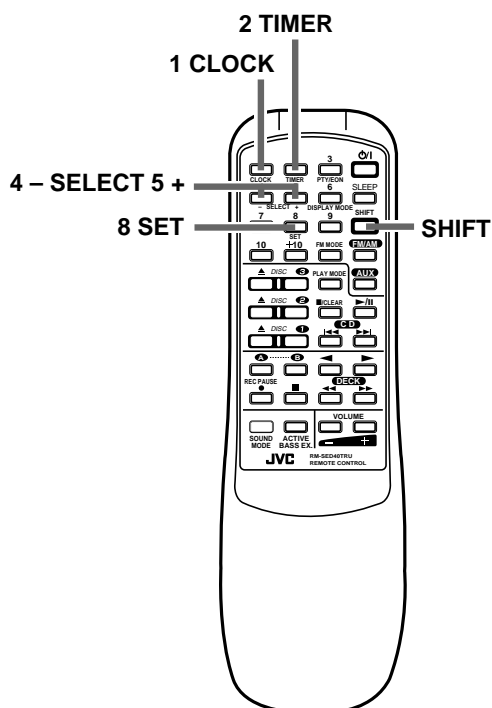

## Display

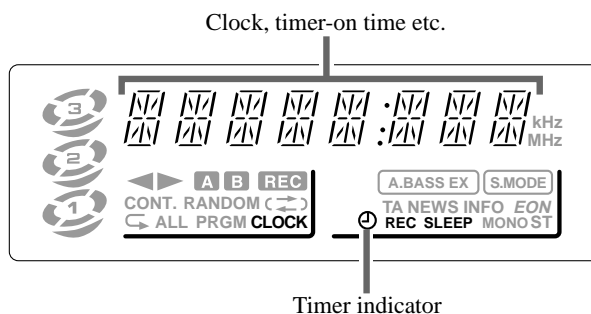

When the System is being used, the display shows other items as well. However, we have only shown the items described in this section.

The timers lets you control listening and recording functions automatically.  
Use the Remote Control to set the clock and timers.

## Setting the Clock

The timers depend on the clock: the clock must be right for the timers to work as you expect. You can set the clock whether the Unit is on or off.

**Note that the clock must be set, otherwise the timers cannot be set.**

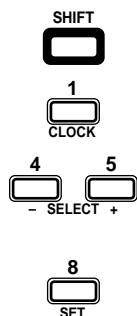

**1. Press the SHIFT button.**

**2. Press the 1 CLOCK button.**

The "CLOCK" indicator on the display lights up and the clock time blinks.

**3. Press the SELECT 5 + or 4 - button to set the time.**

Pressing the 5 + button increases the time and pressing 4 - decreases the time. Pressing the button continuously advances or decreases the time in 10 minute intervals.

**4. Press the 8 SET button.**

The blinking time display changes from a blinking display to a steady display and the clock timer starts from 0 seconds.

**CAUTION: If there is a power failure, the clock loses its setting. The display shows "0:00", and the clock must be reset.**

# Setting the Timer

■ You can set the Timer whether the Unit is on or off.

## Procedure For Setting the Timer



### 1. Press the **SHIFT** button.

### 2. Press the **2 TIMER** button.

The Timer indicator on the display lights up and the blinking “TIMER ON” changes to the On Time setting display.

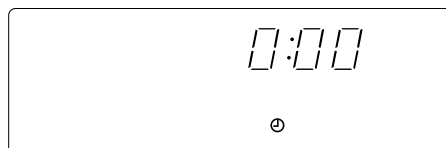
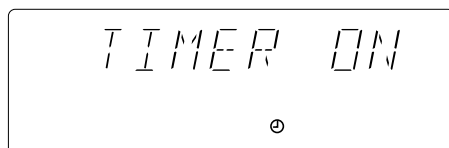

### 3. Set the time you want the Unit to come on.

Press the SELECT 5 + or 4 – button to set the On Time.

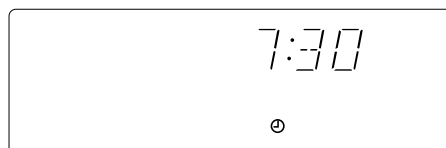

### 4. Press the **8 SET** button.

“TIMER OFF” blinks on the display, and the display changes to the Off Time setting display.

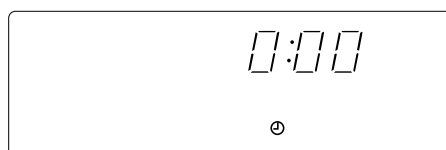
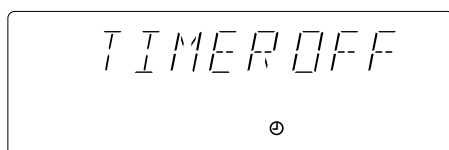

### 5. Set the time you want the Unit to be turned off.

Press the SELECT 5 + or 4 – button to set the Off Time.

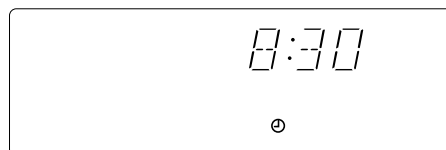

### 6. Press the **8 SET** button.

The name of the source blinks in the display.



### 7. Press the **SELECT 5 + or 4 –** button to select the source.

The display changes with each press of the button as shown.

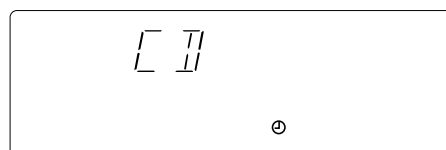

↔ TUNER ↔ TUNER REC ↔ CD ↔ TAPE ↔

**TUNER:** Selects the last station you were listening to.  
**TUNER REC:** Records the last station you were listening to.  
**CD:** Plays the last CD you were listening to.  
**TAPE:** Plays the last tape you were listening to.

- In the source “TUNER”, “CD”, or “TAPE”, the timer acts as a Daily timer. Once the Daily timer has been set, it will be activated at the same time every day until the setting is turned off. In the source “TUNER REC”, the timer acts as a Once timer. After the Once timer has been performed, the details of the setting remain stored but the Timer status is set to off.





### 8. Press the 8 SET button.

The volume level blinks on the display.



### 9. Press the SELECT 5 + or 4 - button to set the volume level.

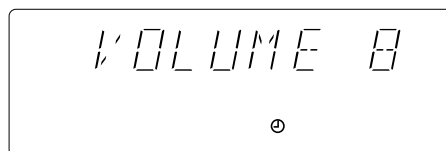

### 10. Press the 8 SET button.

The display returns to the display before you set the timer.

#### Before Turning the Unit Off

- Check that the selected source is ready.
- If you will be recording a source while you are out, set the volume to 0.

To turn the Timer off, press the 2 TIMER button while pressing the SHIFT button. The Timer indicator on the display goes out.

## Setting the SLEEP Timer

Use the Sleep Timer to turn the Unit off after a certain number of minutes when it is playing. By setting this timer, you can fall asleep to music and know your Unit will turn off by itself rather than play all night.

- You can only set the Sleep Timer when the Unit is on and a source is playing.

#### To set the SLEEP Timer, follow this procedure:



### 1. With the System on and a source playing, press the SLEEP button on the Remote Control.

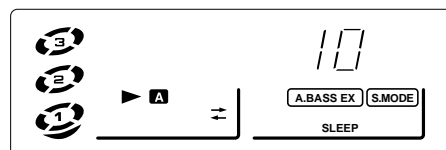

### 2. Set the length of time you want the source to play before shutting off.

- Each time you press this button, it changes the number of minutes shown on the display in this sequence:

→ 10 → 20 → 30 → 60 → 90 → 120 → Cancelled → (back to the beginning)

When the number of minutes you want shows on the display, just wait 5 seconds until the number of minutes stops blinking, and is lighted steadily.

The Unit is now set to turn off after the number of minutes you set.

#### To Change the SLEEP Timer Setting

Press the SLEEP button until the number of minutes you want appears on the display.

#### To Cancel the SLEEP Timer Setting

Press the SLEEP button until the "SLEEP" indicator goes off on the display.

Turning off the Unit also cancels the SLEEP Timer.

# Care And Maintenance

## Compact Discs

Handle your compact discs, cassette tapes, and Cassette Deck carefully, and they will last a long time.



- Remove the CD from the case by holding it at the edges while pressing the centre hole lightly.
- Do not touch the shiny surface of the CD, or bend the CD.



- Put the CD back in its case after use to prevent warping.
- Be careful not to scratch the surface of the CD when placing it back in the case.
- Avoid exposure to direct sunlight, temperature extremes, and moisture.



- A dirty CD may not play correctly. If a CD does become dirty, wipe it with a soft cloth in a straight line from centre to edge.

**CAUTION: Do not use any solvent (for example, conventional record cleaner, spray thinner, benzene, etc.) to clean a CD.**

## Moisture Condensation



Moisture may condense on the lens inside the Unit in the following cases:

- After starting the heating in the room.
- In a damp room.
- If the unit is brought directly from a cold to a warm place.

Should this occur, the Unit may malfunction. In this case, leave the unit turned on for a few hours until the moisture evaporates, unplug the AC power cord, and then plug it in again.

## General Notes

In general, you will have the best performance by keeping your tapes, CDs, and the mechanism clean.

- Store tapes and CDs in their cases, and keep them in cabinets or on shelves.
- Keep the Cassette Deck's tape doors and the CD trays closed when not in use.

## Cassette Tapes

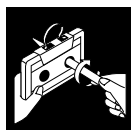

- If the tape is loose in its cassette, take up the slack by inserting a pencil in one of the reels and rotating.
- If the tape is loose, it may get stretched, cut, or caught in the cassette.



- Do not touch the tape surface.



- Do not store the tape:
  - In dusty places
  - In direct sunlight or heat
  - In moist areas
  - On a TV or speaker
  - Near a magnet

## Cassette Deck

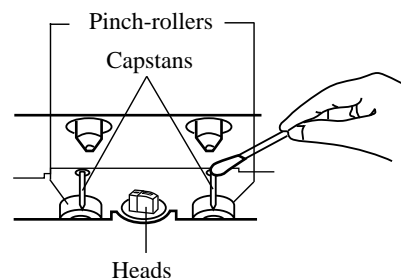

- If the heads, capstans, and pinch-rollers of the Cassette Deck become dirty, the following will occur:
  - Loss of sound quality
  - Discontinuous sound
  - Fading
  - Incomplete erasure
  - Difficulty recording
- Clean the heads, capstans, and pinch-rollers using a cotton swab moistened with alcohol.



- If the heads become magnetized, the Unit will produce noise or lose high frequencies.
- To demagnetize the heads, turn off the Unit, and use a head demagnetizer (available at electronics and record shops).

# Troubleshooting

- If you are having a problem with your System, check this list for a possible solution before calling for service.
- If you cannot solve the problem from the hints given here, or the Unit has been physically damaged, call a qualified person, such as your dealer, for service.

Symptom	Possible Cause	Action
No sound is heard.	Connections are incorrect, or loose.	Check all connections and make corrections. (See pages 4 - 6.)
Unable to record.	Cassette record protect tabs are removed.	Cover holes on back edge of cassette with tape.
Poor radio reception	<ul style="list-style-type: none"> <li>• The antenna is disconnected.</li> <li>• The AM Loop Antenna is too close to the Unit.</li> <li>• The FM Wire Antenna is not properly extended and positioned.</li> </ul>	<ul style="list-style-type: none"> <li>• Reconnect the antenna securely.</li> <li>• Change the position and direction of the AM Loop Antenna.</li> <li>• Extend FM Wire Antenna to the best reception position.</li> </ul>
The CD skips.	The CD is dirty or scratched.	Clean or replace the CD.
Unable to operate the Remote Control.	<ul style="list-style-type: none"> <li>• The path between the Remote Control and the sensor on the Unit is blocked.</li> <li>• The batteries have lost their charge.</li> </ul>	<ul style="list-style-type: none"> <li>• Remove the obstruction.</li> <li>• Replace the batteries.</li> </ul>
The CD tray cannot be opened.	The main AC power cord is not plugged in.	Plug in the AC power plug.
The CD does not play.	The CD is upside down.	Put the CD in with the label side up.
Operations are disabled.	The built-in microprocessor has malfunctioned due to external electrical interference.	Unplug the Unit then plug it back in.
The cassette door cannot be opened.	During tape playing, the power cord was unplugged.	Plug in the power cord, press the  button, and then press the  EJECT button.

# Specifications

## Amplifier

### CA-D551TR/CA-D451TR

Output Power (IEC 268-3/DIN) 27 watts per channel, min. RMS, both channels driven into 6 ohms at 1 kHz with no more than 0.9% total harmonic distortion.

### CA-D351TR

Output Power (IEC 268-3/DIN) 12 watts per channel, min. RMS, both channels driven into 4 ohms at 1 kHz with no more than 0.9% total harmonic distortion.

Input Sensitivity/Impedance (1 kHz)

AUX 300 mV/50 kohms

### CA-D551TR/CA-D451TR

Speaker terminals 6 - 16 ohms

### CA-D351TR

Speaker terminals Minimum 4 ohms

## Cassette Deck

Frequency Response

Type II (CrO<sub>2</sub>) : 50 - 14,000 Hz

Type I (NORMAL) : 50 - 14,000 Hz

Wow And Flutter 0.15% (WRMS)

## CD Automatic Changer

CD Capacity 3 discs

Dynamic Range 85 dB

Signal-To-Noise Ratio 90 dB

Wow And Flutter Unmeasurable

## Tuner

FM Tuner

Tuning Range 87.5 - 108.0 MHz

AM Tuner

Tuning Range

MW 522 - 1,629 kHz

LW 144 - 288 kHz

### CA-D551TR/CA-D451TR

Dimensions 265 x 295 x 339 mm (W/H/D)  
(10-7/16 x 11-5/8 x 13-3/8 inches)

Mass 7.1 kg (15.7 lbs)

### CA-D351TR

Dimensions 265 x 295 x 339 mm (W/H/D)  
(10-7/16 x 11-5/8 x 13-3/8 inches)

Mass 6.7 kg (14.8 lbs)

## Accessories

AM (MW/LW) Loop Antenna (1)

Remote Control (1)

Batteries R6P (SUM-3)/AA (15F) (2)

FM Wire Antenna (1)

## Power Specifications

### CA-D551TR/CA-D451TR

Power Requirements AC 230 V  $\sim$ , 50 Hz

Power Consumption 95 watts

12 watts (in standby mode)

### CA-D351TR

Power Requirements AC 230 V  $\sim$ , 50 Hz

Power Consumption 55 watts

12 watts (in standby mode)

*Design and specifications are subject to change without notice.*

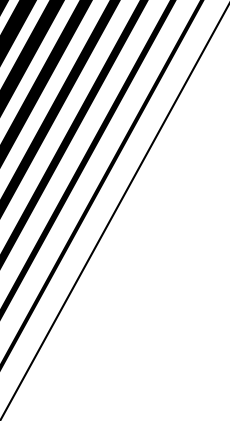

**JVC**  
VICTOR COMPANY OF JAPAN, LIMITED

## Free Manuals Download Website

<http://myh66.com>

<http://usermanuals.us>

<http://www.somanuals.com>

<http://www.4manuals.cc>

<http://www.manual-lib.com>

<http://www.404manual.com>

<http://www.luxmanual.com>

<http://aubethermostatmanual.com>

Golf course search by state

<http://golfingnear.com>

Email search by domain

<http://emailbydomain.com>

Auto manuals search

<http://auto.somanuals.com>

TV manuals search

<http://tv.somanuals.com>