

## COMPACT COMPONENT SYSTEM

## NX-D2 — Consists of CA-NXD2 and SP-NXD3

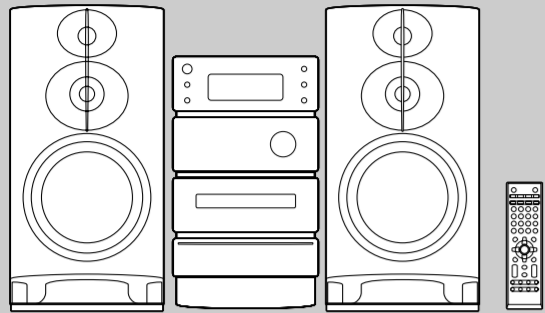

Thank you for purchasing a JVC product. Before operation, please read the instructions carefully.

For customer use:  
Enter below the Model No. and Serial No. which are located either on the rear, bottom or side of the cabinet. Retain this information for future reference.  
Model No. \_\_\_\_\_  
Serial No. \_\_\_\_\_

**INSTRUCTIONS**

GVTO277-007AUJ  
1209WVKMDW/JMM



©2009 Victor Company of Japan, Limited



MP3/WMA

V<sub>HD</sub> BASS

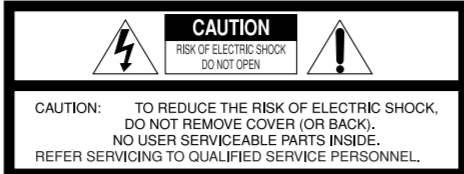
**Warnings, Cautions and Others****Mises en garde, précautions et indications diverses**

The lightning flash with arrowhead symbol, within an equilateral triangle, is intended to alert the user to the presence of uninsulated "dangerous voltage" within the product's enclosure that may be of sufficient magnitude to constitute a risk of electric shock to persons.



The exclamation point within an equilateral triangle is intended to alert the user to the presence of important operating and maintenance (servicing) instructions in the literature accompanying the appliance.



Le symbole de l'éclair à l'intérieur d'un triangle équilatéral est destiné à alerter l'utilisateur sur la présence d'une "tension dangereuse" non isolée dans le boîtier du produit. Cette tension est suffisante pour provoquer l'électrocution de personnes.



Le point d'exclamation à l'intérieur d'un triangle équilatéral est destiné à alerter l'utilisateur sur la présence d'opérations d'entretien importantes au sujet desquelles des renseignements se trouvent dans le manuel d'instructions.



**WARNING:**  
TO PREVENT FIRE OR SHOCK HAZARDS, DO NOT EXPOSE THIS APPARATUS TO RAIN OR MOISTURE.

**AVERTISSEMENT:**  
POUR PRÉVENIR LES RISQUES D'INCENDIE OU DE CHOCS ÉLECTRIQUES, NE PAS EXPOSER CE APPAREIL À LA PLUIE OU À L'HUMIDITÉ.

**For U.S.A.**

**Caution:** Changes or modifications not expressly approved by party responsible for compliance could void the user's authority to operate the equipment.

**Note:** This equipment has been tested and found to comply with the limits for a Class B digital device, pursuant to Part 15 of the FCC Rules. These limits are designed to provide reasonable protection against harmful interference in a residential installation. This equipment generates, uses and can radiate radio frequency energy and, if not installed and used in accordance with the instructions, may cause harmful interference to radio communications. However, there is no guarantee that interference will not occur in a particular installation. If this equipment does cause harmful interference to radio or television reception, which can be determined by turning the equipment off and on, the user is encouraged to try to correct the interference by one or more of the following measures:

- Reorient or relocate the receiving antenna.
- Increase the separation between the equipment and receiver.
- Connect the equipment into an outlet on a circuit different from that to which the receiver is connected.
- Consult the dealer or an experienced radio/TV technician for help.

**Pour les Etats-Unis**

**Attention :** Les changements ou les modifications qui ne sont pas explicitement approuvés par la partie responsable de l'observance pourraient mettre fin au droit de l'utilisateur d'utiliser le matériel.  
**Remarque :** Cet appareil a été testé et il s'est avéré conforme aux limites applicables à un appareil numérique de classe B, en vertu de la Partie 15 des Règles de la FCC. Ces limites sont conçues de manière à assurer une protection raisonnable contre les interférences nuisibles dans une installation résidentielle. Cet appareil produit, utilise et peut émettre une énergie de haute fréquence et, s'il n'est pas installé et utilisé en conformité avec les instructions, il peut causer des interférences nuisibles aux communications radio. Il n'y a, toutefois, aucune garantie que des interférences ne se produiront pas dans une installation particulière. Si cet appareil cause effectivement des interférences nuisibles à la réception de la radio ou de la télévision, ce qu'on peut établir en mettant l'appareil en marche et à l'arrêt, nous encourageons l'utilisateur à tenter de corriger l'interférence par une ou plusieurs des mesures suivantes :

- réorienter ou déplacer l'antenne de réception ;
- accroître la séparation entre l'appareil et le récepteur ;
- brancher l'appareil dans une prise ou un circuit autre que celui auquel le récepteur est branché ;
- consulter un vendeur ou un technicien radio/TV expérimenté pour obtenir de l'aide.

**CAUTION**

- Do not block the ventilation openings or holes. (If the ventilation openings or holes are blocked by a newspaper or cloth, etc., the heat may not be able to get out.)
- Do not place any naked flame sources, such as lighted candles, on the apparatus.
- When discarding batteries, environmental problems must be considered and local rules or laws governing the disposal of these batteries must be followed strictly.
- Do not expose this apparatus to rain, moisture, dripping or splashing and that no objects filled with liquids, such as vases, shall be placed on the apparatus.

**ATTENTION**

- Ne bloquez pas les orifices ou les trous de ventilation. (Si les orifices ou les trous de ventilation sont bloqués par un journal un tissu, etc., la chaleur peut ne pas être évacuée correctement de l'appareil.)
- Ne placez aucune source de flamme nue, telle qu'une bougie, sur l'appareil.
- Lors de la mise au rebut des piles, veuillez prendre en considération les problèmes de l'environnement et suivre strictement les règles et les lois locales sur la mise au rebut des piles.
- N'exposez pas cet appareil à la pluie, à l'humidité, à un égouttement ou à des éclaboussures et ne placez pas des objets remplis de liquide, tels qu'un vase, sur l'appareil.

**CAUTION**

Battery shall not be exposed to excessive heat such as sunshine, fire or the like.

**ATTENTION**

Les piles ne doivent en aucun cas être exposées à une chaleur excessive (lumière du soleil, feu, etc.).

**CAUTION: Proper Ventilation**

To avoid risk of electric shock and fire, and to prevent damage, locate the apparatus as follows:

1. Front: No obstructions and open spacing.
2. Sides/Top/Back: No obstructions should be placed in the areas shown by the dimensions below.
3. Bottom: Place on the level surface. Maintain an adequate air path for ventilation by placing on a stand with a height of 10 cm (3-15/16") or more.

**ATTENTION: Aération correcte**

Pour prévenir tout risque de décharge électrique ou d'incendie et éviter toute détérioration, installez l'appareil de la manière suivante:

1. Avant: Bien dégagé de tout objet.
2. Côtés/dessus/dessous: Assurez-vous que rien ne bloque les espaces indiqués sur le schéma ci-dessous.
3. Dessous: Posez l'appareil sur une surface plane et horizontale. Veillez à ce que sa ventilation correcte puisse se faire en le plaçant sur un support d'au moins dix centimètres de hauteur.

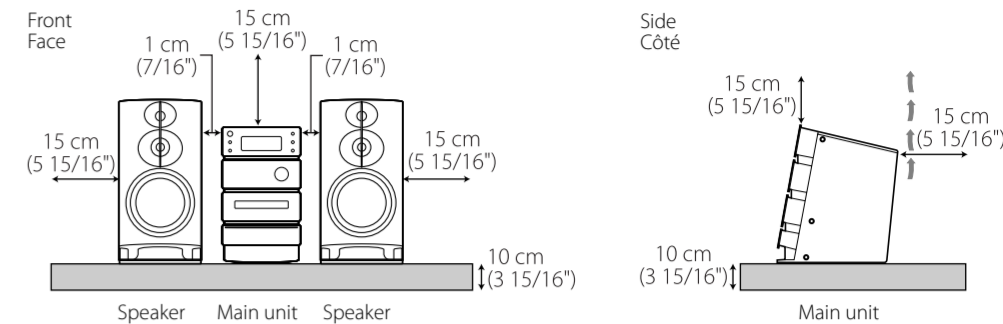
**For Canada**

THIS DIGITAL APPARATUS DOES NOT EXCEED THE CLASS B LIMITS FOR RADIO NOISE EMISSIONS FROM DIGITAL APPARATUS AS SET OUT IN THE INTERFERENCE-CAUSING EQUIPMENT STANDARD ENTITLED "DIGITAL APPARATUS," ICES-003 OF THE DEPARTMENT OF COMMUNICATIONS.

**Pour le Canada**

CET APPAREIL NUMÉRIQUE RESPECTE LES LIMITES DE BRUITS RADIOÉLECTRIQUES APPLICABLES AUX APPAREILS NUMÉRIQUES DE CLASSE B PRÉSCRITES DANS LA NORME SUR LE MATÉRIEL BROUILLEUR; "APPAREILS NUMÉRIQUES", NMB-003 ÉDICTÉE PAR LE MINISTRE DES COMMUNICATIONS.

**CAUTION**

To reduce the risk of electrical shocks, fire, etc.:

1. Do not remove screws, covers or cabinet.
2. Do not expose this appliance to rain or moisture.

**ATTENTION**

Afin d'éviter tout risque d'électrocution, d'incendie, etc.:

1. Ne pas enlever les vis ni les panneaux et ne pas ouvrir le coffret de l'appareil.
2. Ne pas exposer l'appareil à la pluie ni à l'humidité.

**CAUTION**

The button in any position does not disconnect the mains line. Disconnect the mains plug to shut the power off completely (the STANDBY lamp goes off).

The MAINS plug or an appliance coupler is used as the disconnect device, the disconnect device shall remain readily operable.

- When the System is on standby, the STANDBY lamp lights red.
- When the System is turned on, the STANDBY lamp goes off.

The power can be remote controlled.

**ATTENTION**

La touche , dans n'importe quelle position, ne déconnecte pas le système du secteur. Déconnectez la fiche de secteur pour mettre l'appareil complètement hors tension (le témoin STANDBY s'éteint). La fiche secteur ou un coupleur est utilisé comme dispositif de déconnexion de l'appareil, et l'appareil déconnecté doit être prêt à être utilisé.

- Quand le système est en attente, le témoin STANDBY est allumé en rouge.
- Quand le système est sous tension, le témoin STANDBY s'éteint.

L'alimentation peut être télécommandée.

**IMPORTANT FOR LASER PRODUCTS**

1. CLASS 1 LASER PRODUCT
2. **CAUTION:** Do not open the top cover or cabinet. There are no user serviceable parts inside the unit; leave all servicing to qualified service personnel.
3. **CAUTION:** Visible and/or invisible class 1M laser radiation when open. Do not view directly with optical instruments.
4. REPRODUCTION OF LABEL: CAUTION LABEL, PLACED INSIDE THE UNIT.

**IMPORTANT POUR PRODUITS LASER**

1. PRODUIT LASER CLASSE 1
2. **ATTENTION:** N'ouvrez pas le couvercle supérieur ni le coffret de l'appareil. Il n'y a aucune pièce réparable par l'utilisateur à l'intérieur de l'appareil; confiez toute réparation à un personnel qualifié.
3. **ATTENTION:** Rayonnement laser visible et/ou invisible de classe 1M une fois ouvert. Ne pas regarder directement dans le faisceau avec des instruments optiques.
4. REPRODUCTION DE L'ÉTIQUETTE: ÉTIQUETTE DE PRÉCAUTION PLACÉE À L'INTÉRIEUR DE L'APPAREIL.

<b>CAUTION</b> VISIBLE AND/OR INVISIBLE CLASS 1M LASER RADIATION WHEN OPEN. DO NOT VIEW DIRECTLY WITH OPTICAL INSTRUMENTS. REGARDEZ DIRECTEMENT AVEC DES INSTRUMENTS OPTIQUES.	<b>ATTENTION</b> RUYONNEMENT LASER VISIBLE ET/OU INVISIBLE DE CLASSE 1M UNE FOIS OUVERT. NE PAS REGARDER DIRECTEMENT DANS LE FAISCEAU AVEC DES INSTRUMENTS OPTIQUES.	<b>AVISO</b> RADIACION LASER DE CLASE 1M VISIBLE TO INVISIBLE CUANDO ESTA ABIERTO. NO MIRAR DIRECTAMENTE DENTRIN MED OPTICA INSTRUMENTOS.	<b>WARNING</b> VISIBLE AND/OR INVISIBLE CLASS 1M LASER RADIATION WHEN OPEN. DO NOT VIEW DIRECTLY WITH OPTICAL INSTRUMENTS. REGARDEZ DIRECTEMENT AVEC DES INSTRUMENTS OPTIQUES.	<b>注意</b> 可視光線と不可視光線 のレーザー放射が、開 いた状態で発生する 場合があります。直 接、光学器具を用い て覗きません。	<b>CAUTION</b> VISIBLE AND/OR INVISIBLE CLASS 1 LASER RADIATION WHEN OPEN. DO NOT VIEW DIRECTLY WITH OPTICAL INSTRUMENTS. REGARDEZ DIRECTEMENT AVEC DES INSTRUMENTS OPTIQUES.
---	--	---	---	---	--

**CAUTION:**

Excessive sound pressure from earphones or headphones can cause hearing loss.

**ATTENTION:**

Une pression acoustique excessive des écouteurs ou du casque d'écoute peut entraîner une perte auditive.



[European Union only]

[Union européenne seulement]

**Precautions****Notes on the power cord**

- When you are away on travel or otherwise for an extended period of time, remove the plug from the wall outlet.
- When unplugging the System from the wall outlet, always pull the plug, not the power cord.
- Do not handle the power cord with wet hands.
- Disconnect the power cord before cleaning the System or moving the System.
- Do not alter, twist or pull the power cord, or put anything heavy on it, which may cause fire, electric shock, or other accidents.
- If the cord is damaged, consult a dealer and have the power cord replaced with a new one.

**Avoid moisture, water, dust, and high temperatures**

- Do not place the System in moist or dusty places.
- If water gets inside the System, turn off the power and remove the plug from the wall outlet, then consult your dealer. Using the System in this state may cause a fire or electrical shock.
- Do not expose the System to direct sunlight or place it near a heating device.

**Notes on installation**

- Select a place which is level, dry and neither too hot nor too cold—between 5°C and 35°C (41°F and 95°F).
- Do not install the System in a place subject to vibrations.
- Do not put heavy objects on the System.
- Do not drag or push the speakers on the floor or table; otherwise, the four feet at the bottom side of each speaker may peel off or drop from the speaker.

**To prevent malfunction or damage of the System**

- Do not insert any metallic objects, such as wires, hairpins, coins, etc. into the System.
- Do not block the vents.

**There are no user-serviceable parts inside. If anything goes wrong, unplug the power cord and consult your dealer.**

**Introduction****Playable Disc/File Types**

	<b>MP3/WMA</b>
<ul style="list-style-type: none"> <li>• CD-R/-RW: Recorded in the Audio CD format. MP3, WMA files written in accordance with the "ISO 9660" format can also be played.</li> <li>• USB device: MP3, WMA files.</li> </ul>	

In addition to the above discs/files, this System can play back audio data recorded on CD-Extra and CD-G (CD-Graphics).

- The following discs cannot be played back: CD-I (CD-I Ready), and Photo CD. Playing back these discs will generate noise and damage the speakers.
- CD Text can be played, but text information will not be shown on the display.

## Connections

Do not connect the power cord until all other connections have been made.

### Supplied Accessories

After unpacking, check to be sure that you have all the following items.

- FM antenna (x1)
- AM loop antenna (x1)
- Composite video cord (x1)
- Remote control; RM-SNXD2J (x1)
- Batteries (x2)

If any items are missing, consult your dealer immediately.

### AM/FM antenna

AM loop antenna (supplied)  
Turn it until the best reception is obtained.

FM antenna (supplied)  
Extend it so that you can obtain the best reception.

### To assemble the AM loop antenna

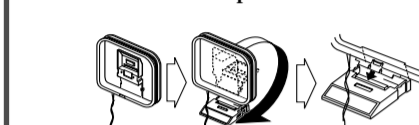

Keep the AM loop antenna cable wrapped around the AM loop antenna frame, otherwise the effectiveness and sensitivity of the AM loop antenna may be reduced.

For better FM reception, disconnect the supplied FM antenna, and connect to an outdoor FM antenna using a 75 Ω wire with coaxial type connector (not supplied).

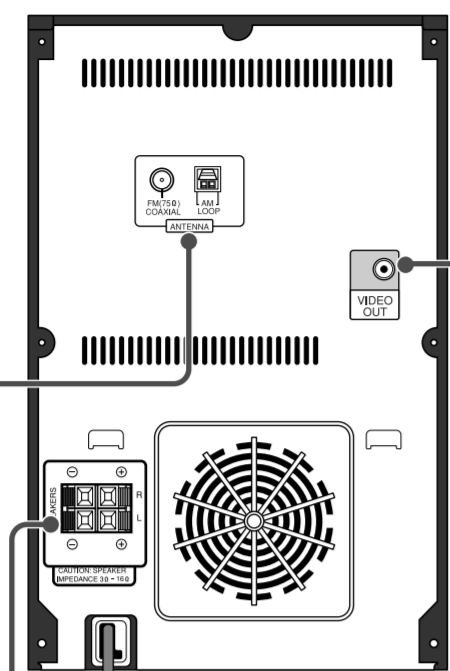

To the wall outlet

### Speakers

When connecting the speaker cords, match the polarity of the speaker terminals: red to (+) and black to (-)

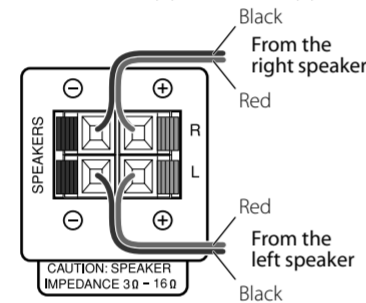

### TV/monitor

Connect your TV directly to the System. Connecting the System to a TV via other device, such as a VCR or an HDD/DVD recorder, may interfere with your viewing. Connecting an integrated TV/VCR system to the System may also interfere with your viewing.

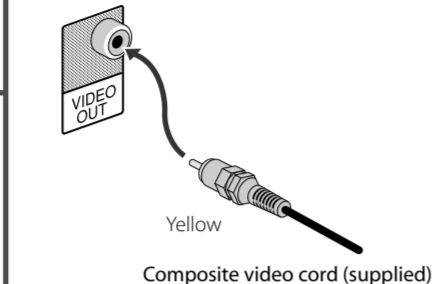

Yellow  
Composite video cord (supplied)

## Preparations

### Preparing the remote control

Insert the batteries into the remote control by matching the polarity (+ and -) correctly.

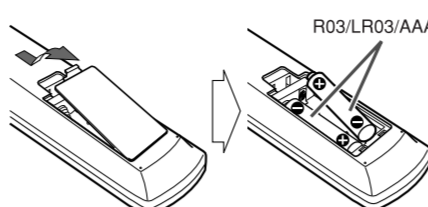

If the range or effectiveness of the remote control decreases, replace both batteries.

**Caution:**  
Be careful your children do not put the batteries into their mouths.

## Basic Operations

In this manual, operations using the remote control are mainly explained; however, you can use the buttons and controls on the main unit if they have the same (or similar) name and marks.

Button and control operations are explained in the table below.

	Indicates that you press the button.
	Indicates that you press and hold the button for a specified period.
	Indicates that you slide your finger on the volume jog in the specified direction(s).

### How to cancel the demonstration

Press and hold ECO/DEMO button on the main unit (until "DEMO CLEAR" appears on the display) while on standby.

- When the ECO Mode is activated, the demonstration does not work.
- Refer to the attached sheet "Information about the demonstration function."

### When using the remote control

Point the top of the remote control towards the remote sensor as directly as possible. If you operate it from a diagonal position, the operating range (about 5 m and/or 16 feet) may be shorter.

DO NOT turn off the System with the volume set at an extremely high level; otherwise, the sudden blast of sound may damage your hearing, speakers and/or headphones when you turn on the System or start playback.

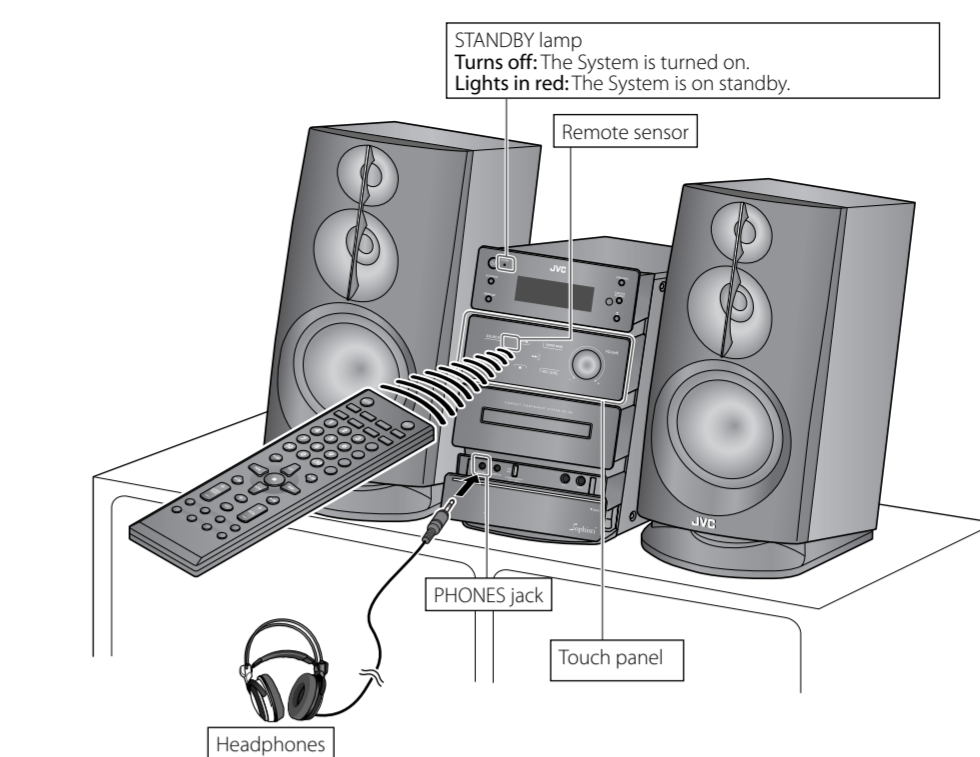

### For private listening

Connect a pair of headphones to the PHONES jack on the main unit. The sound will no longer come out of the speakers. "HPHONE IN" appears on the display for a while. Be sure to turn down the volume before connecting or putting on the headphones.

- Disconnecting the headphones will activate the speakers again.
- When using the headphones with the L-shaped plug, connect it with the head of the plug facing the right side as illustrated below.

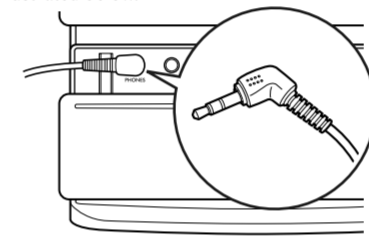

### Motion Sensor

When you move your hand close to the remote sensor in the following cases, the illumination on the front panel turns on.

- While the System is on standby.
- When "DIMMER 1" or "DIMMER 2" is selected.

To activate or deactivate the motion sensor, press MOTION SENSOR.



- When the motion sensor is activated, "SELECT SOURCE" appears on the display while on standby.
- When the motion sensor is deactivated, the clock is shown on the display while on standby.
- When the ECO Mode is activated, the motion sensor does not work.

### Turning On/Off the Power

On the main unit	On the remote

Selecting a source (see below) while in standby mode also turns on the System.

### Selecting the Source

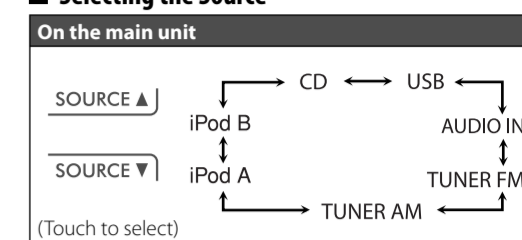

(Touch to select)

### On the remote

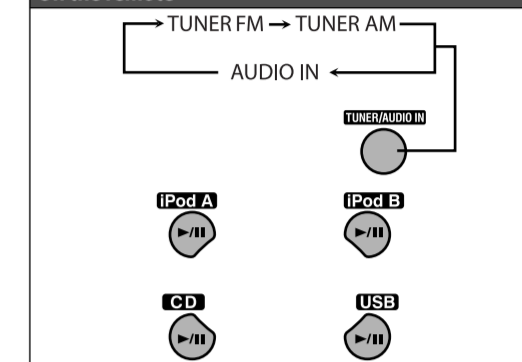

### Adjusting the Volume

On the main unit	On the remote

**Volume +:** Slide your finger clockwise.  
**Volume -:** Slide your finger counterclockwise.

### To drop the volume in a moment



To restore the volume, press again or adjust the volume level.

## Troubleshooting

### General

Adjustments or settings are suddenly canceled before you finish.

⇒ There is a time limit. Repeat procedure again.

Operations are disabled.

⇒ The built-in microprocessor may malfunction due to external electrical interference. Unplug the power cord and then plug it back in.

Unable to operate the System from the remote control.

⇒ The path between the remote control and the remote sensor on the System is blocked.

⇒ The batteries are exhausted.

No sound is heard.

⇒ Speaker connections are incorrect or loose.

⇒ Headphones are connected.

No picture appears on the TV screen.

⇒ The video cord connections are incorrect or loose.

### iPod Device Playback Operations

Content on an iPod cannot be played back even though "CONNECT" is displayed in the display window.

⇒ The battery of the iPod is running low.

The iPod cannot be controlled from this unit.

⇒ The iPod is not compatible with this unit.

### Disc/USB Device Playback Operations

The disc does not play.

⇒ The disc is placed upside down. Place the disc with the label side facing up.

ID3 Tag on an MP3 file cannot be shown.

⇒ Two types of ID3 Tag exist—Version 1 and Version 2. This System can only show ID3 Tag Version 1.

Tracks are not played back as you expect.

⇒ The playing order is determined when the groups and tracks were recorded. It depends on the writing application.

MP3, WMA files are not played back.

⇒ The disc or the USB device may contain different types of files (ex. MP3/WMA/WAV/JPEG).

The disc sound is discontinuous.

⇒ The disc is scratched or dirty.

The disc tray does not open or close.

⇒ The power cord is not plugged in.

⇒ Child Lock is in use. "LOCKED" appears on the display (refer to "Listening to a Disc/USB Device" in "Operating Guide").

### Radio Operations

Hard to hear broadcasts because of noise.

⇒ Antenna connections are incorrect or loose.

⇒ The AM loop antenna is too close to the System.

⇒ The FM antenna is not properly extended and positioned.

### Timer Operations

Daily Timer does not work.

⇒ The System has been turned on when the on-time comes. Timer starts working only when the System is turned off.

## Maintenance

To get the best performance of the System, keep your discs clean.

### Handling Discs

- Remove the disc from its case by holding it at the edge while pressing the center hole lightly.
- Do not touch the shiny surface of the disc, or bend the disc.
- Put the disc back in its case after use to prevent warping.
- Be careful not to scratch the surface of the disc when placing it back in its case.
- Avoid exposure to direct sunlight, extreme temperature, and moisture.

### To clean the disc

Wipe the disc with a soft cloth in a straight line from center to edge.

## Specifications

### Amplifier section

Output Power: 115 W per channel, min. RMS, driven into 3 Ω at 1 kHz with no more than 10% total harmonic distortion

### Audio Input:

AUDIO IN: Stereo mini (φ 3.5 mm)  
500 mV/47 kΩ (at "AUDIO LVL3")  
250 mV/47 kΩ (at "AUDIO LVL2")  
125 mV/47 kΩ (at "AUDIO LVL1")

### USB PLAY (input)

VIDEO OUT (iPod): NTSC (interlaced)  
Color system: NTSC (interlaced)  
VIDEO (Composite): 1 V(p-p)/75 Ω

Speaker impedance: 3 Ω – 16 Ω

### Tuner section

FM tuning range: 87.5 MHz – 108.0 MHz  
AM tuning range: 530 kHz – 1 710 kHz

### Disc player section

Dynamic range: 80 dB  
Horizontal resolution: 500 lines  
Wow and flutter: Immeasurable

### iPod section

Power supply: DC 5 V ≐ 500 mA (each iPod dock)

### Cleaning the System

- Stains should be wiped off with a soft cloth. If the System is heavily stained, wipe it with a cloth soaked in water-diluted neutral detergent and wrung well, then wipe clean with a dry cloth.
- Since the System may deteriorate in quality, become damaged or get its paint peeled off, be careful about the following:
  - DO NOT wipe it with a hard cloth.
  - DO NOT wipe it forcefully.
  - DO NOT apply any volatile substance such as insecticides to it.
  - DO NOT allow any rubber or plastic to remain in contact for a long time.

### Changing the Display Brightness

You can dim the display and illumination lamp. Setting DIMMER allows you to reduce power consumption.



DIMMER 1	Dims the display and the blue illumination on the main unit.
DIMMER 2	Dims the display more than DIMMER 1 and turns off the blue illumination on the main unit.
DIMMER OFF	Normal brightness.

### Setting the ECO (Ecology) Mode

Setting the ECO Mode allows you to reduce power consumption by turning the display off while on standby. While the System is on standby...

On the main unit	On the remote

To cancel, repeat the procedure.

### Turning Off the Power Automatically

#### Auto Standby

- This does not function while "FM," "AM" or "AUDIO IN" is selected as the source.



To cancel, press the button again.

### Sleep Timer

1 Specify the time (in minutes).

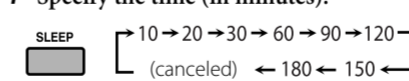

2 Wait until the set time disappears.

To check the time remaining until the shut-off time, press SLEEP once.

### Display Indicators

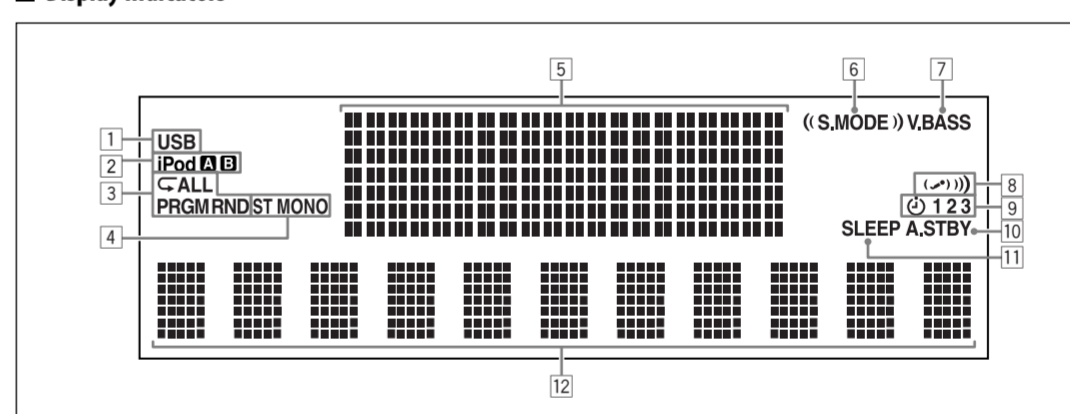

- 1 USB indicator
- 2 iPod indicator
- 3 Playback mode indicators
  - PRGM (Program) indicator
  - RND (Random) indicator
  - Repeat Mode indicators
  - ALL / C
- 4 FM reception indicators
- 5 Level meter
- 6 Sound Mode indicators
  - S.MODE (Sound Mode) indicator
  - (( )) (Surround) indicator
- 7 V. BASS (Vario Bass) indicator
- 8 Karaoke operation indicators
  - (( )) (Mic Mixing) indicator
  - )) (Echo) indicator
- 9 Timer indicators
- 10 A.STBY (Auto Standby) indicator
- 11 SLEEP indicator
- 12 Main display

### To change the display information

- The information displayed and its order vary among the source.

On the main unit	On the remote

### AUDIO IN:

Current source information → Clock

TUNER AM or FM:

Frequency → Clock

### CD:

Current source information → Group name, file name and tag information (for MP3, WMA) → Disc or file type (while stopped) → Clock

USB:

Current source information → Group name, file name and tag information (for MP3, WMA) → Disc or file type (while stopped) → Clock

### iPod:

Current source information → Tag information (artist name, album name, track name)\*1 → Clock

\*1 Tag information cannot be displayed for some iPod models (refer to "Enjoying Movies/Music from your iPod" in "Operating Guide").

### Changing the pattern of the level meter

You can select the appearance of the level meter from 5 patterns ("LVL MTR 1" – "LVL MTR 5").

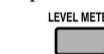

### Using the number buttons and cursor buttons on the remote control

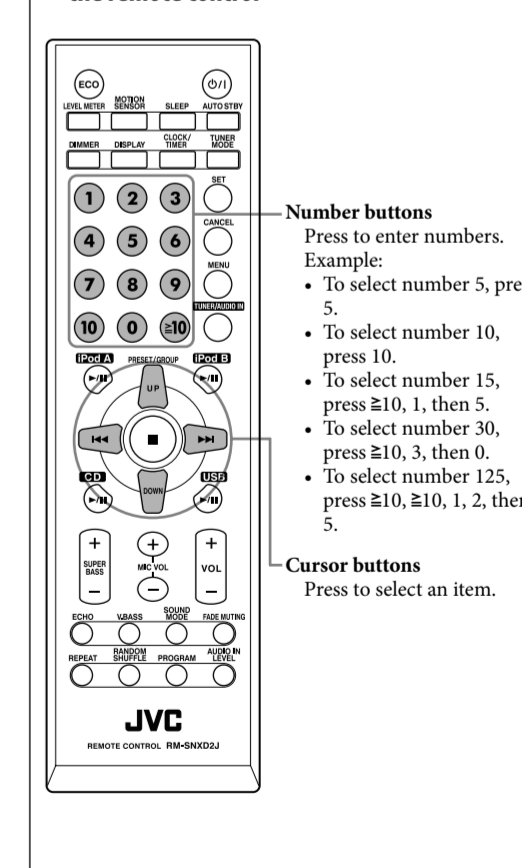

#### Number buttons

Press to enter numbers.

- Example:
- To select number 5, press 5.
  - To select number 10, press 10.
  - To select number 15, press 10, 1, then 5.
  - To select number 30, press 10, 3, then 0.
  - To select number 125, press 10, 12, 5.

#### Cursor buttons

Press to select an item.

## Free Manuals Download Website

<http://myh66.com>

<http://usermanuals.us>

<http://www.somanuals.com>

<http://www.4manuals.cc>

<http://www.manual-lib.com>

<http://www.404manual.com>

<http://www.luxmanual.com>

<http://aubethermostatmanual.com>

Golf course search by state

<http://golfingnear.com>

Email search by domain

<http://emailbydomain.com>

Auto manuals search

<http://auto.somanuals.com>

TV manuals search

<http://tv.somanuals.com>