

JVC

MICRO COMPONENT SYSTEM

UX-F2B

—consists of CA-UXF2B and SP-UXF2B

INSTRUCTIONS



MP3/WMA

Thank you for purchasing a JVC product.

For turning off the demonstration display, see "Canceling the display demonstration" in "Initial settings."

LVT2119-015A[US/UK]
0410YOMMDWCDT

©2010 Victor Company of Japan, Limited

Precautions

- Notes on the power cord**
- When you go away for an extended period of time, remove the plug from the wall outlet.
 - When unplugging the System from the wall outlet, always pull the plug, not the power cord.
 - Do not handle the power cord with wet hands.
 - Disconnect the power cord before cleaning the System or moving the System.
 - Do not alter, twist or pull the power cord, or put anything heavy on it, which may cause fire, electric shock, or other accidents.
- Avoid moisture, water, dust, and high temperatures**
- Do not place the System in moist or dusty places.
 - If water gets inside the System, turn off the power and remove the plug from the wall outlet, then consult your dealer. Using the System in this state may cause a fire or electrical shock.
 - Do not expose the System to direct sunlight or place it near a heating device.

- Notes on installation**
- Select a place which is level, dry and neither too hot nor too cold—between 5°C and 35°C.
 - Do not install the System in a place subject to vibrations.
 - Do not put heavy objects on the System.
- To prevent malfunction or damage to the System**
- Do not insert any metallic objects, such as wires, hairpins, coins, etc. into the System.
 - Do not block the vents.

There are no user-serviceable parts inside. If anything goes wrong, unplug the power cord and consult your dealer.

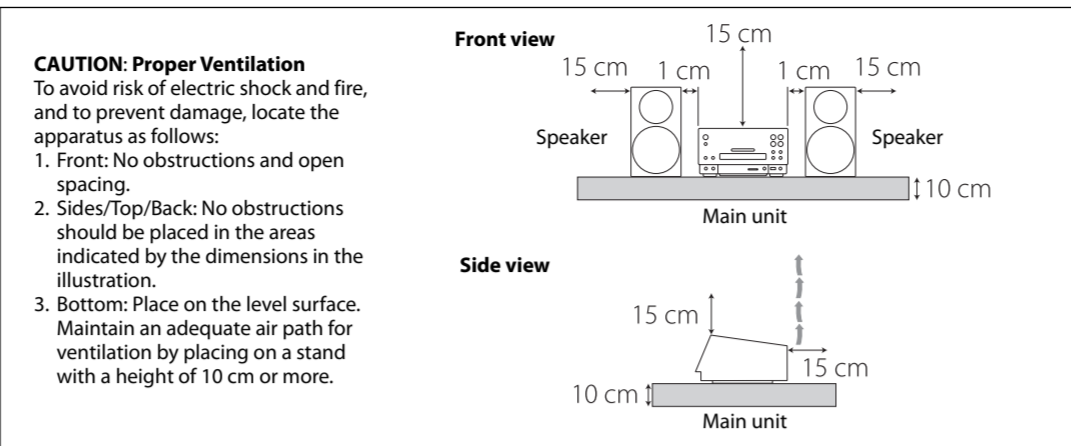

Specifications

Main unit—CA-UXF2B		Speaker—SP-UXF2B	
General		Speaker type:	Bass-reflex type
Power source:	AC 110 – 127 V/AC 220 – 240 V ~ (adjustable with the voltage selector), 50 Hz/60 Hz	Tweeter:	4 cm
Power consumption (at operation):	40 W	Woofer:	12 cm
Power consumption (on standby):	1.00 W or less	Impedance:	6 Ω
Dimensions (approx.) (W x H x D) (including projecting parts):	236 mm x 123 mm x 285 mm	Dimensions (approx.) (W x H x D) (including projecting parts):	141 mm x 250 mm x 181 mm
Mass (approx.):	2.0 kg	Mass (approx.):	1.8 kg each
Amplifier		Supplied accessories	See "Supplied accessories" in "Getting started."
Output Power:	100 W (50 W + 50 W) at 6 Ω (10% THD)		
Audio Input:	AUDIO IN: Stereo mini (ø 3.5 mm)		
Speaker impedance:	6 Ω - 16 Ω		
Tuner			
FM frequency:	87.50 MHz – 108.00 MHz (at 9 kHz intervals)		
AM frequency:	531 kHz – 1710 kHz (at 9 kHz intervals) 530 kHz – 1710 kHz (at 10 kHz intervals)		
USB			
USB specification:	Compatible with USB 2.0 Full Speed		
Compatible device:	Mass storage class		
Compatible system:	FAT16, FAT32		
Output power:	DC 5 V ~ 500 mA		
SD			
Compatible device:	SD, SDHC		
Compatible system:	FAT16, FAT32		

• Microsoft and Windows Media are either registered trademarks or trademarks of Microsoft Corporation in the United States and/or other countries.
• SDHC Logo is a trademark.

Getting started

- Supplied accessories**
- After unpacking, check to make sure that you have all the following items:
- Remote control (x 1)
 - Lithium coin battery CR2025 (x 1) – The battery has been installed in the remote control when shipped from the factory.
 - AM loop antenna (x 1)
 - FM antenna (x 1)
 - AC plug adaptor (x 1)
- If anything is missing, consult your dealer immediately.

In this manual...

The remote control buttons are used for explaining the operations unless mentioned otherwise. However, if the System has the same or similar button names, they can also be used for the operations.

- "SD card" refers to both SD card and SDHC card.
- "File" and "track" are used interchangeably.

- Prepare the remote control**
- When you use the remote control for the first time, pull out the insulation sheet.

To replace the battery in the remote control

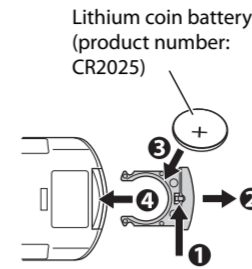

- NOTES:**
- Store the battery in a place where children cannot reach. If a child accidentally swallows the battery, consult a doctor immediately.
 - To prevent the battery from overheating, cracking, or starting a fire:
 - Do not recharge, short, disassemble or heat the battery or dispose of it in a fire.
 - Do not leave the battery with other metallic materials.
 - Wrap the battery with tape and insulate when throwing away or saving it.
 - Do not poke the battery with tweezers or similar tools.
 - Dispose of battery in the proper manner, according to federal, state, and local regulations.
 - The battery (battery pack or battery installed) shall not be exposed to excessive heat source such as sunshine, fire or the like.

CAUTION:
Danger of explosion if battery is incorrectly replaced. Replace only with the same or equivalent type.

Connections

Do not connect the AC power cord until all other connections have been made.

- NOTES:**
- Make sure the antenna conductors do not touch any other terminals, connecting cords or the power cord. Also, keep the antennas away from metallic parts of the System, connecting cords, and the AC power cord. Otherwise, it could cause poor reception.
 - When connecting the speaker cords, match the polarities of the speaker terminals: red to (+) and black to (-).
 - DO NOT connect more than one speaker to each terminal.
 - Use only speakers with the same speaker impedance as indicated by the speaker terminals on the rear of the System.
 - DO NOT allow the conductor of the speaker cords to come into contact with the metallic parts of the System.

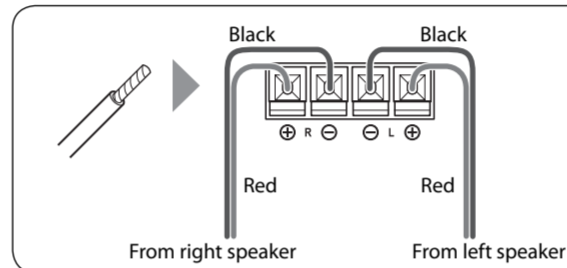

Voltage selector switch (on the bottom of the System)

CAUTION for mains (AC) line

BEFORE PLUGGING IN, do check that your mains (AC) line voltage corresponds with the position of the voltage selector switch provided on the outside of this equipment and, if different, reset the voltage selector switch, to prevent from a damage or risk of fire/electric shock.

FM antenna (supplied): Extend it so that you can obtain the best reception.

For better FM reception
Disconnect the supplied FM antenna, and connect to an outdoor FM antenna (not supplied) using a 75 Ω wire with coaxial type connector.

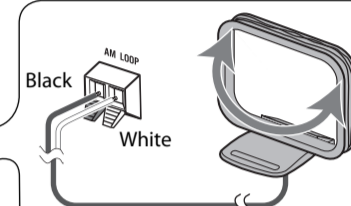

AM loop antenna (supplied): Turn it until the best reception is obtained.
NOTE: Keep the AM loop antenna cable wrapped around the AM loop antenna frame, otherwise the effectiveness and sensitivity of the AM loop antenna may be reduced.

To a wall outlet
• If a wall outlet does not match the AC plug, use the supplied AC plug adaptor.

Maintenance

- To get the best performance of the System, keep your discs and the mechanism clean.
- Handling discs**
- Remove the disc from its case by holding it at the edge while pressing the center hole lightly.
 - Do not touch the shiny surface of the disc, or bend the disc.
 - Put the disc back in its case after use.
 - Be careful not to scratch the surface of the disc when placing it back in its case.
 - Avoid exposure to direct sunlight, temperature extremes, and moisture.
- To clean the disc:**
- Wipe the disc with a soft cloth in a straight line from center to edge.
- Cleaning the System**
- Stains should be wiped off with a soft cloth. If the System is heavily stained, wipe it with a cloth soaked in water-diluted neutral detergent and wrung well, then wipe clean with a dry cloth.
 - Since the System may deteriorate in quality, become damaged or get its paint peeled off, be careful about the following:
 - DO NOT wipe it hard.
 - DO NOT wipe it with thinner or benzene.
 - DO NOT apply any volatile substances such as insecticides to it.
 - DO NOT allow any rubber or plastic to remain in contact for a long time.

Playable disc/file

- This System can play back...
 - Audio CD and CD-R/CD-RW in Audio CD format.
 - MP3/WMA files on a CD-R/CD-RW (ISO 9660 format), USB mass storage class device (maximum data transfer rate: 2 Mbps) or SD card.
- This System cannot play "packet write" discs.
- This System can recognize up to 255 groups on a disc. The total number of groups and tracks (on a disc) that can be recognized by the System is 512 (for MP3/WMA).
- This System can recognize up to 99 groups and 999 tracks (with a maximum number of 255 tracks in a group) on a USB mass storage class device/SD card.
- For MP3/WMA playback...
 - Some MP3/WMA files may not be played back due to their recording conditions.
 - This System can play only discs of ISO 9660 Level 1 or Level 2.
 - It is recommended to record each file at a sampling rate of 44.1 kHz and at a data transfer rate of 128 kbps.
 - This System cannot play back files made at a bit rate of less than 64 kbps.
 - This System can show the Tag data (version 1).
- For playback of files on a USB mass storage class device/SD card.
 - You cannot play back files larger than 2 GB.
 - This System may not play back some USB mass storage class devices/SD card and does not support DRM (Digital Rights Management).

About SCMS (Serial Copy Management System)

The System uses the Serial Copy Management System which allows only first-generation digital copies to be made of premastered software such as regular CDs. If you try to record from a duplicated CD-R or CD-RW to a USB mass storage class device or SD card, "PROTECT" appears on the display.

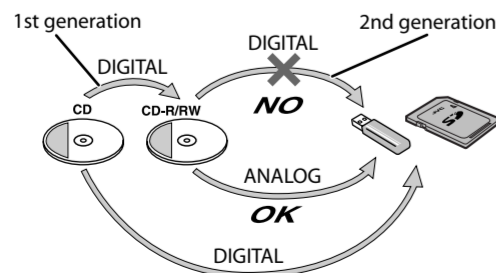

Troubleshooting

If you are having a problem with your System, check this list for a possible solution before calling for service.

General	
Power does not come on.	➔ Power plug is not inserted securely. Plug it in securely.
Adjustments or settings are suddenly canceled before you finish.	➔ There is a time limit. Start the procedure again.
Unable to operate the System from the remote control.	➔ The path between the remote control and the remote sensor on the System is blocked. ➔ The battery is exhausted.
No sound is heard.	➔ Speaker connections are incorrect or loose. ➔ Headphones are connected.
Radio	
Hard to listen to broadcasts because of noise.	➔ Antenna connection is incorrect or loose. ➔ The AM loop antenna is too close to the System. ➔ The FM antenna is not properly extended and positioned. ➔ Electrostatic discharge from your body may cause noise. If this happens, turn the System off then on again.
Disc/USB/SD	
The disc/USB mass storage class device/SD card does not play.	➔ The disc is placed upside down. Place the disc with the label side facing up. ➔ The disc is recorded using "packet writing (UDF file system)." It cannot be played. ➔ The USB mass storage class device is not connected or the SD card is not inserted properly.
"NO DATA" appears on the display.	➔ MP3/WMA files are not recorded on the disc, on the USB mass storage class device or onto the SD card.
ID3 Tag on an MP3 file cannot be shown.	➔ There are two types of ID3 Tag—Version 1 and Version 2. This System can only show ID3 Tag Version 1.
Groups and tracks are not played back as you expect.	➔ Playing order is determined when the groups and tracks are recorded. It depends on the writing application.
The disc/USB mass storage class device/SD card sound is discontinuous.	➔ The disc is scratched or dirty. ➔ MP3/WMA files have not been properly recorded on the USB mass storage class device or onto SD card.
Sound from the USB mass storage class device/SD card is interrupted.	➔ Noise and static electricity may stop the sound. In this case, disconnect and connect the USB mass storage class device or remove and insert the SD card again after turning off the System.
The disc tray does not open or close.	➔ The AC power cord is not plugged in. ➔ Disc ejection is prohibited. "LOCKED" appears (see "Prohibiting disc ejection" in "Disc/USB/SD" on page 2).
Timer	
Daily Timer does not work.	➔ The System was turned on when the on-time came. The timer starts working only when the System is turned off.

- If the System does not work correctly, disconnect the AC power cord from the wall outlet, wait for a while, and connect the cord again.
- JVC bears no responsibility for any loss of data in USB mass storage class device or SD card while using this System.

Sound and other adjustments

Initial settings

Canceling the display demonstration

When you plug in and turn on the System, the display demonstration starts automatically if no operation is done for about 2 minutes.

To cancel the display demonstration

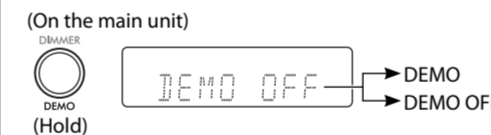

Setting the clock

- CLOCK/TIMER** button.
 - If you have already set the clock before, press and hold **CLOCK/TIMER** until the current time is shown on the display then press **SET** to activate the clock setting mode.
 - Adjust the hour and minute.**
 - Use **UP** and **DOWN** buttons to adjust the time. Press **SET** to confirm.
 - To go back to the previous step, press **MENU/CANCEL**.
- The clock may gain or lose 1 to 2 minutes per month. You may need to readjust the clock periodically.

Display settings

Display brightness

You can dim the display window.



Display information

You can change the information shown on the display.

Ex.: During playback of a CD...

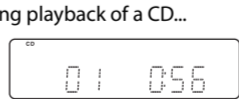

Current track's elapsed time
↑
Clock

- The information shown on the display differs depending on the source.
- Tag information is shown on the display while an MP3/WMA file is played back.

Sound adjustments

Fade muting

To drop the volume in a moment



- To restore the volume, press again or adjust the volume level.

Sound Turbo

To emphasize the sound

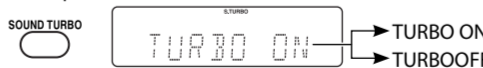

Hyper Bass Sound (HBS)

To reinforce the bass sound

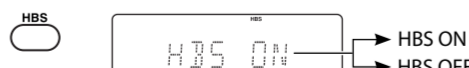

Sound Mode

To select the sound mode suitable for your favorite music



Timers

Sleep Timer

Specify the time (in minutes.)

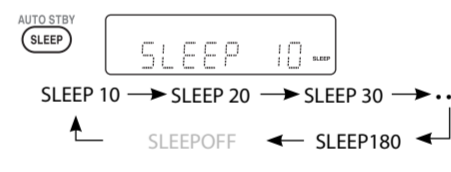

- To check the remaining time until the System shuts off, press **SLEEP** once.

Daily Timer

By using Daily Timer, you can wake up with your favorite music.

- You can store three Daily Timer settings.
- Tune into a station, insert a disc or SD card, or connect a USB mass storage class device to the System beforehand.

1 Select a Daily Timer number.

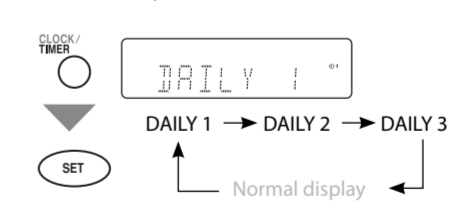

2 Set the timer contents.

- Hour and minute for the on-time and off-time
- Playback source
- Volume
 - If you select "VOL --", the volume is set to the same level as when the System was last turned off.
- To correct a misentry during the process, press **MENU/CANCEL**. You can return to the previous step.
- To exit from Daily Timer setting, press **CLOCK/TIMER** repeatedly as required.

3 Turn off the System.

The display disappears and the STANDBY lamp starts flashing.
• While on standby mode, the timer indicator (⌚) is not displayed.

Basic operation

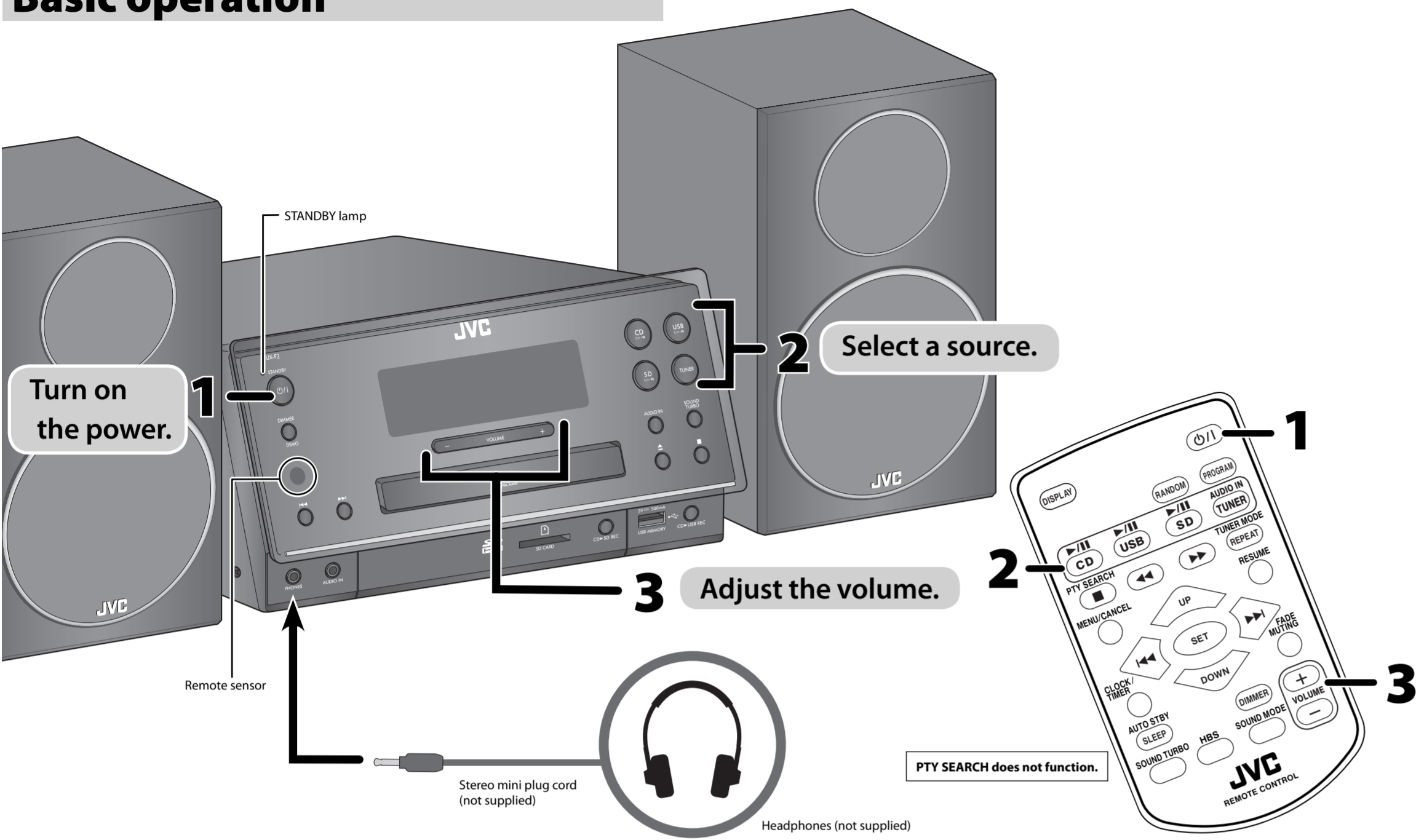

DO NOT turn off the System with the volume set to an extremely high level; otherwise, the sudden blast of sound may damage your hearing, speakers, and headphones when you turn on the System or start playback.

The **HP** indicator is displayed when headphones are connected to the System.
 • Be sure to turn down the volume before connecting or putting on the headphones.

Radio

Selecting the AM tuner interval

Before operating the tuner, select the appropriate AM tuner interval used in your residential area.

1 **AUDIO IN (TUNER)**

TUNER FM → TUNER AM

2 **Select the AM tuner interval.**
 (On the main unit)
 (Hold) 9K → 10K ↔ 10K → 9K

Each time you press and hold **■**, the interval switches between 9 kHz and 10 kHz alternately.

Searching for stations

1 **AUDIO IN (TUNER)**

TUNER FM → TUNER AM

2 **◀▶ (Hold) ▶▶ (Hold)**

The station search stops when a station of sufficient signal strength is found.
 • To manually stop the search, press **◀◀** or **▶▶**.

• When you press **◀◀** or **▶▶** repeatedly, the frequency changes step by step.
 • When an FM program is broadcast in stereo, the **S** (stereo) indicator lights up.

Presetting stations

You can preset up to 30 FM and 15 AM stations.

While listening to a target station...

1 **PROGRAM**

Preset number

2 **UP** **DOWN**

3 **SET**

Tuning in to a preset station

UP **DOWN**

Improving the FM reception

To improve the FM reception

TUNER MODE (REPEAT)

• When the monaural mode is activated, the reception is improved. However, the stereo effect is lost.
 • To restore the stereo effect, press **TUNER MODE** again.

External device

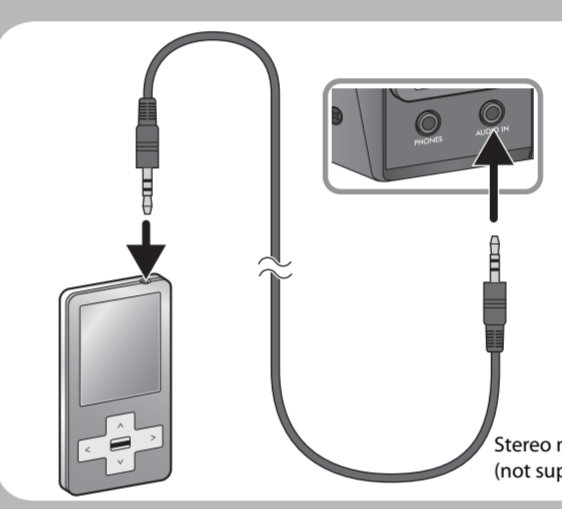

Playback operation

1 **AUDIO IN (TUNER)**

TUNER FM → TUNER AM

2 **Start playback of the external device.**

Adjusting the audio input level

You can change the audio input level through the AUDIO IN jack.

SET (Hold)

LEVEL 1 → LEVEL 2

LEVEL 3

• The playback sound is the maximum when you select LEVEL 3.

Disc/USB/SD

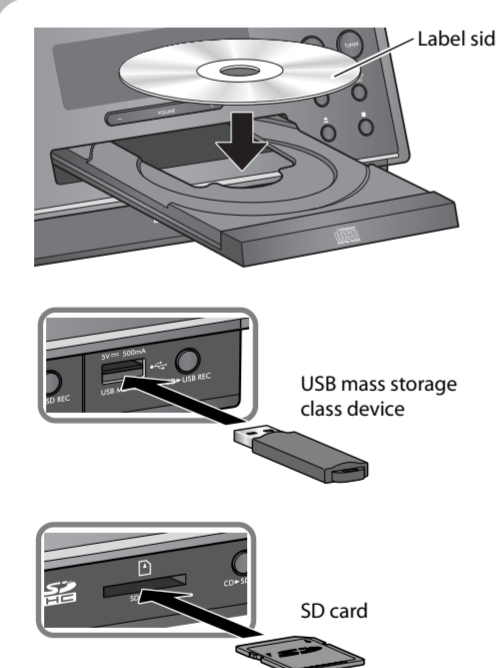

Notes on USB mass storage class device connection

- Connect a USB mass storage class device when the System is turned off to prevent malfunction.
- Do not use a USB hub.
- When connecting with a USB cable, use a USB 2.0 cable whose length is less than 1 m.
- The USB mass storage class device is charged through the USB MEMORY terminal when the System is turned on. (Some USB mass storage class devices may be charged through the USB MEMORY terminal only when "USB" is selected as the source.)
- You cannot connect a computer to the USB MEMORY terminal of the System.
- Electrostatic shock at connecting a USB mass storage class device may cause abnormal playback of the device. In this case, disconnect the USB mass storage class device then reset the System and the USB mass storage class device.
- While playing back or recording a file onto a USB mass storage class device, do not disconnect the device. Doing so may cause malfunction on both the System and the device.

Notes on SD card insertion

- DO NOT insert any object other than an SD card into the insertion slot.
- DO NOT use a cracked or deformed SD card.
- Make sure that SD card playback has stopped before removing the SD card. Otherwise, the data may be damaged.
- Never insert an SD card upside down. Otherwise, it will not be able to be removed.
- When you play a miniSD™ card, be sure to attach the miniSD™ adaptor to the card before insertion.
- SD cards initialised by computer may not be compatible.
- You can use an SD card up to 32 GB.
- Do not remove the SD card while recording. It may cause malfunction.

Playback operations

To play back/pause a disc
CD

To play back/pause a USB mass storage class device
USB

To play back/pause an SD card
SD

To open the disc tray
 Press **▲** on the main unit.

To select a track
 Press **▶▶** or **◀◀**.

To fast-forward a track
 Press **▶▶▶**.
 • To stop fast-forwarding, press **CD ▶▶**, **USB ▶▶** or **SD ▶▶**.

To fast-reverse a track
 Press **◀◀◀**.
 • To stop fast-reversing, press **CD ▶▶**, **USB ▶▶** or **SD ▶▶**.

To select a group
 Press **UP** or **DOWN**.

To stop playback
 Press **■**.

Repeat Play

TUNER MODE (REPEAT) **CD** **C** **ALL**

↶ 1	Repeats the current track.
↶	Repeats the current group (MP3/WMA only).
↶ ALL	Repeats all contents or programmed tracks.
No indicator	Cancels.

Random Play

RANDOM **CD** **RND**

- To cancel Random Play, press **RANDOM** again.

Program Play

While playback is stopped...

1 **PROGRAM**

2 **Select a track number (up to 32 tracks).**
◀◀ **▶▶** **SET**
 • To cancel, press **MENU/CANCEL**.

3 **CD** or **USB** or **SD**

- To check the programmed contents, press **SET** repeatedly while playback is stopped.
- To exit Program Play, press **■** while playback is stopped. – The stored program is erased.

Resume Play

This System stores the beginning of the stopped track on the disc, USB mass storage class device or SD card.

RESUME **RESUME** **RESUME**

When you start playback again, it starts from the beginning of the stored track.

- To clear the stored position...
 – Press **■** twice.
 – Open the disc tray.
 – Disconnect the USB mass storage class device.
 – Remove the SD card.
- This function can not be used for Program Play.

Auto Standby

You can turn off the System automatically.

AUTO STBY (SLEEP) **ASTB ON** **ASTB OFF**

(Hold)

- The **A.STBY** indicator starts flashing after playback stops. If no operation is done for about 3 minutes, the System is turned off.

Prohibiting disc ejection

You can lock the disc tray.

While the System is on standby...
 (On the main unit)

LOCKED **UNLOCKED**

(While holding **■**)

Recording operations

Before you start recording

- It may be unlawful to record or play back copyrighted material without the consent of the copyright owner.
- The volume and sound adjustments (see page 1) do not affect recordings.
- Random Play and Repeat Mode are canceled during recording.
- You can record up to 99 tracks per group on a USB mass storage class device or SD card.
- Tracks which are recorded onto a USB mass storage class device or SD card will be converted into MP3 format.
- Recording does not start while "READING" is shown on the display.
- You cannot record tracks in the root.

Recording from a Disc

You can record tracks from a CD to a USB mass storage class device or an SD card.

Before recording...
 Connect a recordable USB mass storage class device to the USB MEMORY (◀▶) terminal or insert a recordable SD card into the SD CARD (□) slot.

1 **Start and stop playback of the disc.**
CD **PTY SEARCH**

2 **Start recording.**
 (On the main unit)
CD-USB REC or **CD-SD REC**
 The **USB REC** or **SD REC** indicator is flashing.

- Do not vibrate the System while recording. It may damage the recorded tracks.
- The System automatically creates the new group.
- When playback ends, recording automatically stops.
- To stop recording manually, press **■**.
- To record a single track, press **CD▶USB REC** or **CD▶SD REC** on the main unit during playback of the track.
- If "NO REC" appears on the display when you try to record a track, the System cannot record that track.

Free Manuals Download Website

<http://myh66.com>

<http://usermanuals.us>

<http://www.somanuals.com>

<http://www.4manuals.cc>

<http://www.manual-lib.com>

<http://www.404manual.com>

<http://www.luxmanual.com>

<http://aubethermostatmanual.com>

Golf course search by state

<http://golfingnear.com>

Email search by domain

<http://emailbydomain.com>

Auto manuals search

<http://auto.somanuals.com>

TV manuals search

<http://tv.somanuals.com>