

KENWOOD

AUDIO VIDEO SURROUND RECEIVER

VR-506

VR-505

VR-517

KRF-V6050D

KRF-V5050D

KRF-V5550D

INSTRUCTION MANUAL

KENWOOD CORPORATION

This instruction manual is used to describe multiple models listed above. Model availability and features (functions) may differ depending on the country and sales area.

About the supplied remote control

Compared to standard remote controls, the remote control supplied with this receiver has several operation modes. These modes enable the remote control to control other audio/video components. In order to effectively use the remote control it is important to read the operating instructions and obtain a proper understanding of the remote control and how to switch its operation modes (etc.). Using the remote control without completely understanding its design and how to switch the operation modes may result in incorrect operations.

Before applying the power

⚠ Caution : Read this page carefully to ensure safe operation.

Units are designed for operation as follows.

- U.S.A. and Canada** **AC 120 V only**
- Australia** **AC 240 V only**
- Europe and U.K.** **AC 230 V only**
- China and Russia** **AC 220 V only**
- *Other countries** **AC 110-120 / 220-240 V switchable**

Unpacking

Unpack the unit carefully and make sure that all accessories are put aside so they will not be lost. Examine the unit for any possibility of shipping damage. If your unit is damaged or fails to operate, notify your dealer immediately. If your unit was shipped to you directly, notify the shipping company without delay. Only the consignee (the person or company receiving the unit) can file a claim against the carrier for shipping damage. We recommend that you retain the original carton and packing materials for use should you transport or ship the unit in the future.

Keep this manual handy for future reference.

Preparations

* AC voltage selection

The AC voltage selector switch on the rear panel is set to the voltage that prevails in the area to which the unit is shipped. Before connecting the power cord to your AC outlet, make sure that the setting position of this switch matches your line voltage. If not, it must be set to your voltage in accordance with the following direction.

AC voltage selector switch

Move switch lever to match your line voltage with a small screwdriver or other pointed tool.

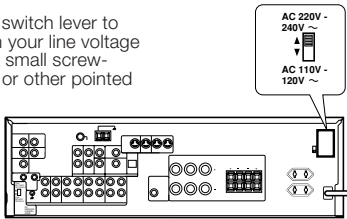

Note:
Our warranty does not cover damage caused by excessive line voltage due to improper setting of the AC voltage selector switch.

Accessories

FM indoor antenna (1)

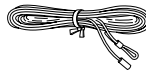

AM loop antenna (1)

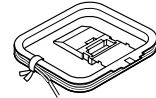

For VR-506 and KRF-V6050D

Remote control unit (1)
RC-R0615

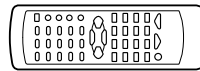

Batteries (R6/AA) (2)

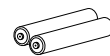

For VR-505 and KRF-V5050D

Remote control unit (1)
RC-R0511

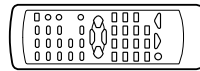

Batteries (R6/AA) (2)

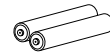

For VR-517 and KRF-V5550D

Remote control unit (1)
RC-R0617

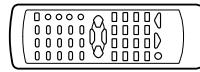

Batteries (R6/AA) (2)

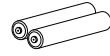

*AC plug adaptor (1)

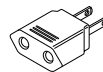

*Use to adapt the plug on the power cord to the shape of the wall outlet. (Accessory only for regions where use is necessary.)

Safety precautions

WARNING :

TO PREVENT FIRE OR ELECTRIC SHOCK, DO NOT EXPOSE THIS APPLIANCE TO RAIN OR MOISTURE.



CAUTION
RISK OF ELECTRIC SHOCK
DO NOT OPEN



CAUTION: TO REDUCE THE RISK OF ELECTRIC SHOCK, DO NOT REMOVE COVER (OR BACK). NO USER-SERVICEABLE PARTS INSIDE, REFER SERVICING TO QUALIFIED SERVICE PERSONNEL.



THE LIGHTNING FLASH WITH ARROWHEAD SYMBOL, WITHIN AN EQUILATERAL TRIANGLE, IS INTENDED TO ALERT THE USER TO THE PRESENCE OF UNINSULATED "DANGEROUS VOLTAGE" WITHIN THE PRODUCT'S ENCLOSURE THAT MAY BE OF SUFFICIENT MAGNITUDE TO CONSTITUTE A RISK OF ELECTRIC SHOCK TO PERSONS.



THE EXCLAMATION POINT WITHIN AN EQUILATERAL TRIANGLE IS INTENDED TO ALERT THE USER TO THE PRESENCE OF IMPORTANT OPERATING AND MAINTENANCE (SERVICING) INSTRUCTIONS IN THE LITERATURE ACCOMPANYING THE APPLIANCE.

Microcomputer malfunction

If operation is not possible or an erroneous display appears, even though all connections have been made properly, reset the microcomputer referring to "In case of difficulty".

- 39 -

Maintenance of the unit



When the front panel or case becomes dirty, wipe with a soft, dry cloth. Do not use thinner, benzine, alcohol, etc. for these agents may cause discoloration.

In regard to contact cleaner

Do not use contact cleaners because it could cause a malfunction. Be specially careful not to use contact cleaners containing oil, for they may deform the plastic component.

Contents

Caution : Read the pages marked  carefully to ensure safe operation.

Preparations	 Before applying the power 2
	 Safety precautions 2
	Unpacking 2
	How to use this manual 4
	Special features 4
	Names and functions of parts 5
	Remote control unit (RC-R0615) (VR-506/KRF-V6050D) 6
	Remote control unit (RC-R0511) (VR-505/KRF-V5050D) 7
	Remote control unit (RC-R0617) (VR-517/KRF-V5550D) 8
	Setting up the system 9
	Connecting audio components 10
	Connecting video components 11
	Connecting a DVD player (6-channel input) 12
	Digital connections 13
	Connecting to the AV AUX jacks (VR-506/517/KRF-V6050D only) 14
Connecting the antennas 14	
Connecting the system control 15	
Connecting the speakers 16	
Preparing the remote control 18	
Preparing for surround sound 19	
Speaker settings 19	
Operations	Normal playback 20
	Preparing for playback 20
	Listening to a source component 21
	Adjusting the sound 21
	Recording 22
	Recording audio (analog sources) 22
	Recording video 23
	Recording audio (digital sources) 23
	Listening to radio broadcasts 23
	Tuning radio stations 23
	Presetting radio stations manually 24
Receiving preset stations 24	
Receiving preset stations in order (P.CALL) 24	
Ambience effects 25	
Surround modes 25	
Surround play 27	
DVD 6-channel playback (VR-506/517/KRF-V6050D/V5050D) 28	
Convenient functions 28	
Remote Control	Basic remote control operations for other components (For VR-506/517/KRF-V6050D/V5550D) 30
	Registering setup codes for other components 30
	Operating other components 30
	Setup code chart 31
	DVD player operation keys (For VR-505/KRF-V5050D) 32
	Cassette deck, CD player & MD recorder operations (For VR-505/KRF-V5050D) 33
	Cassette deck, CD player & MD recorder operations (For VR-506/517/KRF-V6050D/V5550D) 34
	Other components' operations (For VR-506/517/KRF-V6050D/V5550D) 36

Additional Information	In case of difficulty 39
	Specifications 41

For the U.S.A.

FCC WARNING

This equipment may generate or use radio frequency energy. Changes or modifications to this equipment may cause harmful interference unless the modifications are expressly approved in the instruction manual. The user could lose the authority to operate this equipment if an unauthorized change or modification is made.

NOTE:

This equipment has been tested and found to comply with the limits for a Class B digital device, pursuant to Part 15 of the FCC Rules. These limits are designed to provide reasonable protection against harmful interference in a residential installation. This equipment may cause harmful interference to radio communications, if it is not installed and used in accordance with the instructions. However, there is no guarantee that interference will not occur in a particular installation. If this equipment does cause harmful interference to radio or television reception, which can be determined by turning the equipment off and on, the user is encouraged to try to correct the interference by one or more of the following measures:

- Reorient or relocate the receiving antenna.
- Increase the separation between the equipment and receiver.
- Connect the equipment into an outlet on a circuit different from that to which the receiver is connected.
- Consult the dealer or an experienced radio / TV technician for help.

For the U.S.A.

Note to CATV system installer:

This reminder is provided to call the CATV system installer's attention to Article 820-40 of the NEC that provides guidelines for proper grounding and, in particular, specifies that the cable ground shall be connected to the grounding system of the building, as close to the point of cable entry as practical.



As an ENERGY STAR® Partner, Kenwood Corporation has determined that this product meets the ENERGY STAR® guidelines for energy efficiency.

This product can save energy. Saving energy reduces air pollution and lowers utility bills.

How to use this manual

This manual covers the VR-506, VR-505, VR-517, KRF-V6050D, KRF-V5050D and KRF-V5550D. Items such as functions, number of jacks, and remote control details somewhat differ between these models. To confirm the functions available on the model you have purchased, refer to the table below.

Model name	Remote Control	Terminal	
		Speaker out	Front input
VR-506 KRF-V6050D	RC-R0615	2 systems (A, B)	Equipped
VR-505 KRF-V5050D	RC-R0511	1 system	Not equipped
VR-517 KRF-V5550D	RC-R0617	1 system	Equipped (except KRF-V5550D)

This manual is divided into four sections, Preparations, Operations, Remote Control, and Additional Information.

Preparations

Shows you how to connect your audio and video components to the receiver and prepare the surround processor. We will guide you to make setting up your system as easy as possible. However, since this receiver works with all of your audio and video components, connecting the system can be fairly complex.

Operations

Shows you how to operate the various functions available on the receiver.

Remote Control (For VR-506/517/KRF-V6050D/V5550D only)

Shows you how to operate other components using the remote control, as well as a detailed explanation of all remote control operations. Once you have registered your components with the proper setup codes, you'll be able to operate both this receiver and your other AV components (TV, VCR, DVD player, CD player, etc.) using the remote control supplied with this receiver.

Additional Information

Shows you additional information such as "In case of difficulty" (trouble-shooting) and "Specifications".

Memory back up function

Please note that the following items will be deleted from the unit's memory if the power cord is disconnected from the AC outlet for approximately 2 days.

- Power mode.
- Input selector settings.
- Device preset.
- Picture output.
- Speaker ON/OFF
- Volume level.
- BASS, TREBLE, INPUT level.
- Subwoofer ON/OFF.
- Dimmer level.
- Monitor ON/OFF.
- MD/TAPE settings.
- 6ch/2ch input setting.
- Listen mode setting.
- Speaker settings.
- Input mode setting.
- Midnight mode setting.
- Broadcast band.
- Frequency setting.
- Preset stations.
- Tuning mode.
- CINEMA EQ.
- Source Direct.

Special features

True home theater sound

This receiver incorporates a wide variety of surround modes to bring you maximum enjoyment from your video software. Select a surround mode according to your equipment or the software you are going to play and enjoy!

→ 25

Dolby Pro Logic & Dolby 3 Stereo

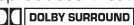
This surround system reproduces theater-like surround sound from video software marked .

The PRO LOGIC mode uses the built-in adaptive matrix circuit to steer the Left, Center, Right and Surround channel audio signals.

The 3 STEREO mode will redirect the Surround signal to the front left and right speakers when only the front and center speakers are used.

Dolby Digital

The DOLBY DIGITAL mode lets you enjoy full digital surround from software processed in the Dolby Digital format. Dolby Digital provides up to 5.1 channels of independent digital audio for better sound quality and more powerful presence than conventional Dolby Surround.

DTS

DTS (Digital Theater System) is a 5.1 channel digital audio format that provides five full-spectrum channels and one low-frequency (subwoofer) channel for unprecedented clarity, optimum channel separation and a (wide) dynamic range.

In the DTS mode, the 5.1 channel digital input from a DTS CD, LD or DVD disc (carrying the "DTS" marking) can be played in Digital Surround.

Important:

When a DTS disc is played on a CD, LD or DVD player, noise may be output from the analog output. It is recommended that you connect the digital output of the player to the digital input of this unit.

DSP surround modes

The DSP (Digital Signal Processor) used for this receiver incorporates a variety of high quality adjustable sound fields, like "ARENA", "JAZZ CLUB", "THEATER", "STADIUM" and "DISCO". It is compatible with almost any kind of program source.

DVD 6-channel input (For VR-506/517/KRF-V6050D/V5050D only)

If you own a DVD player equipped with 6-channel output, this receiver allows you to obtain the full surround sound impact of DVD source material featuring multi-channel encoding. Since the source signals are digital and each channel is input independently, the resulting ambience is far superior to what can be achieved with conventional surround sound systems.

Universal IR (InfraRed) remote control (Except for VR-505/KRF-V5050D)

In addition to the basic receiver, the remote control supplied with this receiver can also operate almost all of your remote controllable audio and video components. Just follow the simple setup procedure to register the components you have connected.

Names and functions of parts

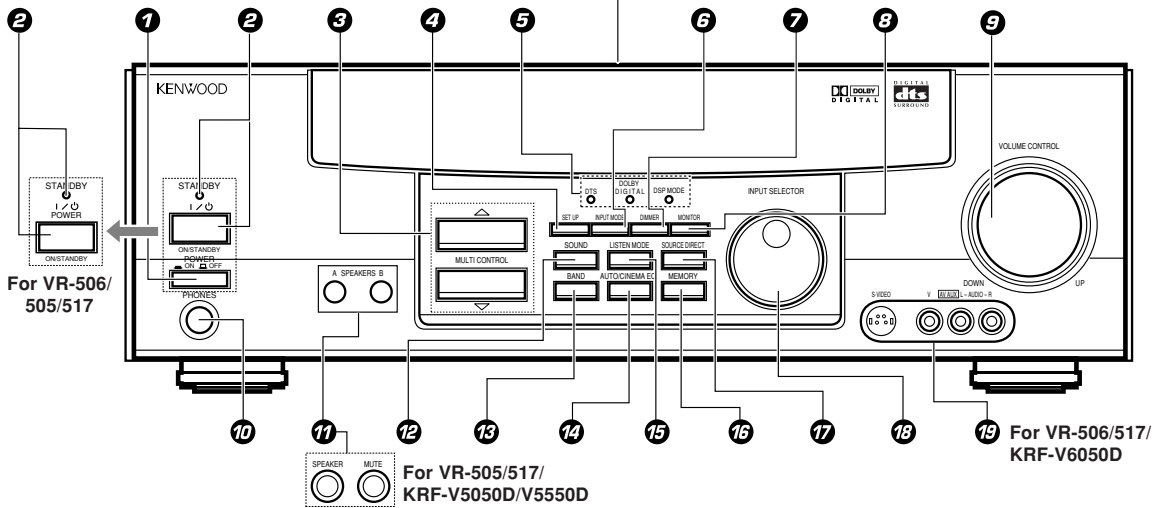
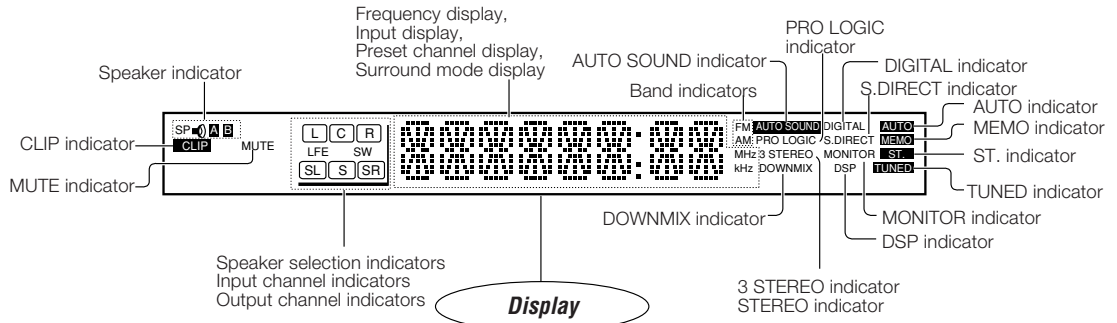

- 1 POWER key** (For KRF-V6050D/V5050D/V5550D) - [19]
Use to turn the main power ON/OFF.
- 2 ON/STANDBY (I/O) key** (For KRF-V6050D/V5050D/V5550D) - [19]
Use to switch the power ON/STANDBY when the POWER is turned ON.
STANDBY indicator
- 2 POWER (I/O) key** (For VR-506/505/517) - [19]
Use to turn the power ON/STANDBY.
STANDBY indicator
- 3 MULTI CONTROL keys** - [19]
Use to control a variety of settings.
- 4 SET UP key** - [19]
- 5 Surround indicators**
DTS indicator - [27]
Lights when the receiver is in the DTS mode.
DOLBY DIGITAL indicator - [27]
Lights when the receiver is in the Dolby Digital mode.
DSP MODE indicator - [27]
Lights up when the receiver is in DSP mode.
- 6 INPUT MODE key** - [9]
Use to switch between the digital and analog inputs.
- 7 DIMMER key** - [23] - [29]
Use to adjust the brightness of the display.
Use to select the REC MODE.
- 8 MONITOR key** - [22]
Use to monitor the source that is connected to the MONITOR jack.
- 9 VOLUME CONTROL knob** - [21]
- 10 PHONES jack** - [22]
Use for headphone listening.
- 11 SPEAKERS A/B keys** (For VR-506/KRF-V6050D) - [20]
Use to turn the A/B speakers ON/OFF.
- 11 SPEAKER key** (For VR-505/517/KRF-V5050D/V5550D) - [20]
Use to turn the speaker ON/OFF.
MUTE key (For VR-505/517/KRF-V5050D/V5550D) - [22]
Use to temporarily mute the sound.
- 12 SOUND key** - [28]
Use to adjust the sound quality and ambience effects.
- 13 BAND key** - [23]
Use to select the broadcast band.
- 14 AUTO/CINEMA EQ. key** - [23]
Use to select the auto tuning mode.
Use to switch the status of CINEMA EQ.
- 15 LISTEN MODE key** - [27]
Use to select the listening mode.
- 16 MEMORY key** - [24]
Use to store radio stations in the preset memory.
- 17 SOURCE DIRECT key** - [22]
Use to pass the source material direct to the amplifier.
- 18 INPUT SELECTOR knob** - [21]
Use to select the input sources.
- 19 AV AUX (S VIDEO, V, AUDIO L/R) jacks** (For VR-506/517/KRF-V6050D) - [14]

Standby mode

When standby indicator is lit, this receiver is in standby mode and consumes a small amount of current for back-up. This system can be switched on using remote controls.

Remote control unit (RC-R0615) (VR-506/KRF-V6050D)

This remote control unit can be used not only for Kenwood products but also for other non-Kenwood products by setting the appropriate maker setup codes. — [31]

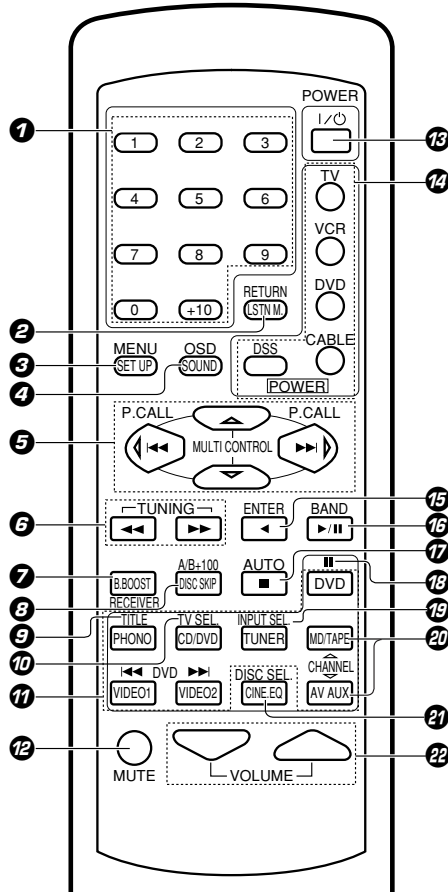

If the name of a function is different on the receiver and on the remote control, the name of the remote control key in this manual is indicated in parentheses.

- 1 Numeric keys** — [35]
Provide functions identical to those of the original remote control supplied with the component you are controlling.
- 2 LSTN M. key** — [27]
Use to select the listening mode.
- 3 RETURN key** — [27]
Use to operate other components.
- 4 SET UP key** — [19]
Use to select the speakers' settings etc.
- 5 MENU key** — [21]
Use to operate other components.
- 6 SOUND key** — [21]
Use to adjust the sound quality and ambience effects.
- 7 OSD key** — [19]
Use to operate other components.
- 8 MULTI CONTROL keys** — [19]
Use to control a variety of settings. Use to operate other components.
- 9 P.CALL <◀▶> keys** — [24]
If tuner is selected as the input source, these keys function as P.CALL keys.
- 10 <◀▶> keys** — [24]
If CD or MD is selected as the input source, these keys function as skip keys.
- 11 TUNING <◀▶> keys** — [21]
Use to operate the tuner or selected component. If CD, MD or TAPE is selected as the input source, these keys function as search keys.

- 12 B. BOOST key** — [21]
Use to select the maximum adjustment setting for the low frequency range.
- 13 RECEIVER key** — [21]
Use to return to the operation of the receiver.
- 14 DISC SKIP key** — [21]
If CD is selected as the input source, this key functions as the multi-CD player disc skip key.
- 15 A/B key** — [21]
If TAPE is selected as the input source, this (A and B) of a double cassette deck.
- 16 +100 key** — [21]
Use to select the disc number with the multi-CD player.
- 17 TITLE key** — [21]
Use to operate other components.
- 18 TV SEL. key** — [21]
Use to operate other components.
- 19 INPUT SELECTOR keys (DVD, PHONO, CD/DVD, TUNER, MD/TAPE, VIDEO1, VIDEO2, AV AUX)** — [21]
Use to select the input sources.
- 20 <◀▶> DVD >>> keys** — [21]
When in DVD player operations, these keys function as skip keys.
- 21 MUTE key** — [22]
Use to temporarily mute the sound.
- 22 POWER (i/o) key** — [18]
Use to turn the receiver on and off.
- 23 POWER key (TV, VCR, DVD, DSS, CABLE)** — [21]
Use to turn the other components on and off.

- 15 ENTER key** — [21]
Use to select the input sources.
- < key** — [21]
If tape is selected as the input source, this key functions as the play key for side B of the cassette (the side facing away from the front of the deck).
- 16 BAND key** — [21]
Use to select the broadcast band.
- >/II key** — [21]
If CD is selected as the input source, this key functions as the play/pause key. If MD or TAPE is selected as the input source, this key functions as the play key.
- 17 AUTO key** — [23]
Use to select the auto tuning mode.
- key** — [21]
If CD, MD or TAPE is selected as the input source, this key functions as the stop key.
- 18 II key** — [21]
Use to operate other components.
- 19 INPUT SEL. key** — [21]
Use to operate other components.
- 20 CHANNEL Δ/▽ key** — [21]
Use to select the channel.
- 21 CINE.EQ key** — [21]
Use to switch the status of CINEMA EQ.
- DISC SEL. key** — [21]
Use to operate other components.
- 22 VOLUME keys** — [21]
Use to adjust the receiver volume.

Remote control unit (RC-R0511) (VR-505/KRF-V5050D)

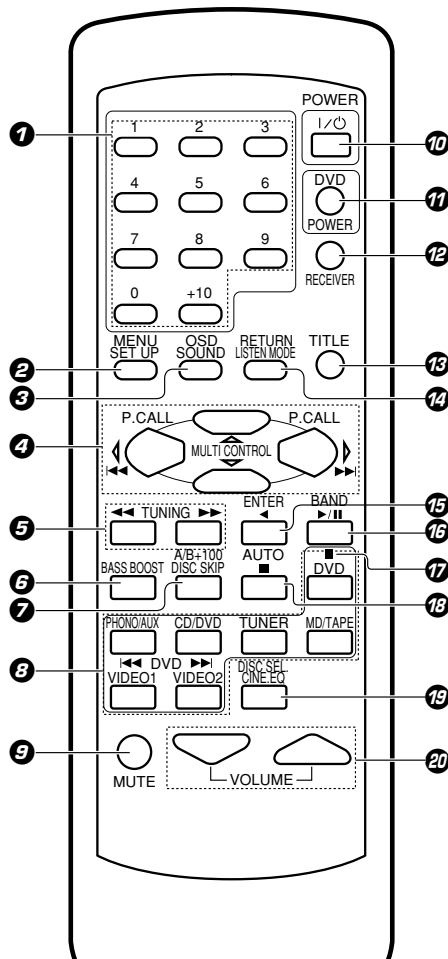

- 1 Numeric keys** - [24]
If CD or MD is selected as the input source, these keys function as numeric keys. If tuner is selected as the input source, these keys are used to call up station presets.
- 2 SET UP key** - [19]
Use to select the speakers' settings etc.
MENU key
Use to operate other components.
- 3 SOUND key** - [21]
Use to adjust the sound quality and ambience effects.
OSD key
Use to operate other components.
- 4 MULTI CONTROL keys** - [19]
Use to control a variety of settings.
P.CALL $\leftarrow \rightarrow$ keys - [24]
If tuner is selected as the input source, these keys function as P.CALL keys.
 $\leftarrow \rightarrow$ keys
If CD or MD is selected as the input source, these keys function as skip keys.
- 5 TUNING** $\leftarrow \rightarrow$ keys
If tuner is selected as the input source, these keys function as tuning keys.
If CD, MD or TAPE is selected as the input source, these keys function as search keys.
- 6 BASS BOOST key** - [21]
Use to select the maximum adjustment setting for the low frequency range.

- 7 DISC SKIP key**
If CD is selected as the input source, this key functions as the multi-CD player disc skip key.
A/B key
If TAPE is selected as the input source, this (A and B) of a double cassette deck.
+100 key
Use to select the disc number with the multi-CD player.
- 8 INPUT SELECTOR keys (DVD, PHONO/AUX, CD/DVD, TUNER, MD/TAPE, VIDEO1, VIDEO2)** - [21]
Use to select the input sources.
 $\leftarrow \rightarrow$ DVD $\rightarrow \leftarrow$ keys
When in DVD player operations, these keys function as skip keys.
- 9 MUTE key** - [22]
Use to temporarily mute the sound.
- 10 POWER (I/O) key** - [18]
Use to turn the receiver on and off.
- 11 DVD POWER key** - [34]
Used to operate DVD player.
For details, refer to the instruction manual of your DVD player. (Press the DVD POWER key for more than 2 seconds.)
- 12 RECEIVER key**
Use to return to the operation of the receiver.
- 13 TITLE key**
Use to operate other components.

- 14 LISTEN MODE key** - [27]
Use to select the listening mode.
RETURN key
Use to operate other components.
- 15 ENTER key**
Use to operate other components.
 \leftarrow key
If tape is selected as the input source, this key functions as the play key for side B of the cassette (the side facing away from the front of the deck).
- 16 BAND key** - [23]
Use to select the broadcast band.
 \rightarrow /II key
If tape is selected as the input source, this key functions as the play/pause key.
If MD or TAPE is selected as the input source, this key functions as the play key.
- 17 II key**
Use to operate other components.
- 18 AUTO key** - [23]
Use to select the auto tuning mode.
 \blacksquare key
If CD, MD or TAPE is selected as the input source, this key functions as the stop key.
- 19 CINE.EQ key**
Use to switch the status of CINEMA EQ.
DISC SEL. key
Use to operate other components.
- 20 VOLUME keys** - [21]
Use to adjust the receiver volume.

Remote control unit (RC-R0617) (VR-517/KRF-V5550D)

This remote control unit can be used not only for Kenwood products but also for other non-Kenwood products by setting the appropriate maker setup codes. - [31]

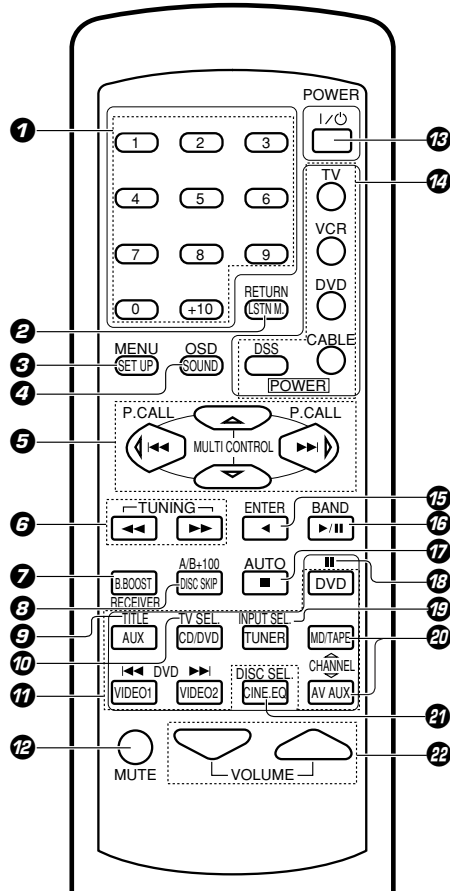

If the name of a function is different on the receiver and on the remote control, the name of the remote control key in this manual is indicated in parentheses.

- 1 Numeric keys** - [35]
Provide functions identical to those of the original remote control supplied with the component you are controlling.
- 2 LSTN M. key** - [27]
Use to select the listening mode.
- 3 RETURN key**
Use to operate other components.
- 4 SET UP key** - [19]
Use to select the speakers' settings etc.
- 5 SOUND key** - [21]
Use to adjust the sound quality and ambience effects.
- 6 OSD key**
Use to operate other components.
- 7 MULTI CONTROL keys** - [19]
Use to control a variety of settings. Use to operate other components.
- 8 P.CALL <◀▶> keys** - [24]
If tuner is selected as the input source, these keys function as P.CALL keys.
- 9 <◀▶> keys**
If CD or MD is selected as the input source, these keys function as skip keys.
- 10 TUNING <◀▶> keys**
Use to operate the tuner or selected component.
- If CD, MD or TAPE is selected as the input source, these keys function as search keys.

- 7 B.BOOST key** - [21]
Use to select the maximum adjustment setting for the low frequency range.
- RECEIVER key**
Use to return to the operation of the receiver.
- 8 DISC SKIP key**
If CD is selected as the input source, this key functions as the multi-CD player disc skip key.
- A/B key**
If TAPE is selected as the input source, this (A and B) of a double cassette deck.
- +100 key**
Use to select the disc number with the multi-CD player.
- 9 TITLE key**
Use to operate other components.
- 10 TV SEL. key**
Use to operate other components.
- 11 INPUT SELECTOR keys (DVD, AUX, CD/DVD, TUNER, MD/TAPE, VIDEO1, VIDEO2, AV AUX)** - [21]
Use to select the input sources.
- <◀ DVD ▶> keys**
When in DVD player operations, these keys function as skip keys.
- 12 MUTE key** - [22]
Use to temporarily mute the sound.
- 13 POWER (I/O) key** - [18]
Use to turn the receiver on and off.
- 14 POWER key (TV, VCR, DVD, DSS, CABLE)**
Use to turn the other components on and off.

- 15 ENTER key**
Use to operate other components.
- < key**
If tape is selected as the input source, this key functions as the play key for side B of the cassette (the side facing away from the front of the deck).
- 16 BAND key** - [23]
Use to select the broadcast band.
- >|| key**
If CD is selected as the input source, this key functions as the play/pause key.
- If MD or TAPE is selected as the input source, this key functions as the play key.
- 17 AUTO key** - [23]
Use to select the auto tuning mode.
- key**
If CD, MD or TAPE is selected as the input source, this key functions as the stop key.
- 18 || key**
Use to operate other components.
- 19 INPUT SEL. key**
Use to operate other components.
- 20 CHANNEL Δ/▽ key**
Use to select the channel.
- 21 CINE.EQ key**
Use to switch the status of CINEMA EQ.
- DISC SEL. key**
Use to operate other components.
- 22 VOLUME keys** - [21]
Use to adjust the receiver volume.

Setting up the system

Make connections as shown in the following pages. When connecting the related system components, be sure to also refer to the instruction manuals supplied with the components you are connecting. Do not connect the power cord to a wall outlet until all connections are completed.

DTS disclaimer clause

DTS Digital Surround™ is a discrete 5.1 channel digital audio format available on CD, LD, and DVD software which consequently cannot be decoded and played back inside most CD, LD, or DVD players. For this reason, when DTS-encoded software is played back through the analog outputs of the CD, LD, or DVD player, excessive noise will be exhibited. To avoid possible damage to the audio system, proper precautions should be taken by the consumer if the analog outputs are connected directly to an amplification system. To enjoy DTS Digital Surround™ playback, an external 5.1 channel DTS Digital Surround™ decoder system must be connected to the digital output (S/P DIF, AES/EBU, or TosLink) of the CD, LD or DVD player.

VIDEO 2/MONITOR jacks

The receiver's **VIDEO 2/MONITOR** jacks can be used in two different ways. Make the appropriate setting for the component connected to the jack when the receiver is turned on.

Use as a VIDEO 2 jack

You can connect a video deck or the like to these jacks and perform video playback and recording. The initial factory setting is "VIDEO 2".

Use as a MONITOR jack

You can connect a cassette deck or the like to these jacks and make use of the deck's monitoring function during recording. Alternately, you can connect a graphic equalizer to these jacks to apply compensation to the music signal.

To use the **VIDEO 2/MONITOR** jacks as a **MONITOR** jack, hold down the **MONITOR** key of the main unit for more than two seconds so that the display below appears.

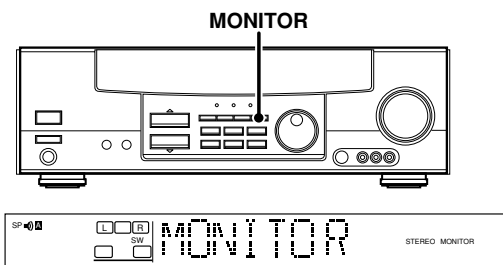

To switch the setting back to "VIDEO 2," once again hold down the **MONITOR** key for more than two seconds.

Notes

1. Be sure to insert all connection cords securely. If their connections are imperfect, the sound may not be produced or noise may interfere.
2. Be sure to remove the power cord from the AC outlet before plugging or unplugging any connection cords. Plugging/unplugging connection cords without disconnecting the power cord can cause malfunctions and may damage the unit.
3. Do not connect power cords from components whose power consumption is larger than what is indicated on the AC outlet at the rear of this unit.

Analog connections

Audio connections are made using RCA pin cords. These cables transfer stereo audio signal in an "analog" form. This means the audio signal corresponds to the actual audio of two channels. These cables usually have 2 plugs each end, one red for the right channel and one white for the left channel. These cables are usually packed together with the source unit, or are available at your local electronics retailer.

Input mode settings

CD/DVD, VIDEO2 and DVD/6ch or DVD (VR-505/KRF-V5550D only) inputs each include jacks for digital audio input and analog audio input. You must select beforehand which type of input is to be used for each connected component.

The initial factory settings for audio signal playback (CD/DVD, DVD/6ch or DVD (VR-505/KRF-V5550D only)) and (VIDEO2) are digital and analog respectively.

To use the analog audio input for playback instead (if, for example, you have connected a VCR to the VIDEO2 input), you must set the input mode for the corresponding input to the analog mode. After completing connections and turning on the receiver, follow the steps below.

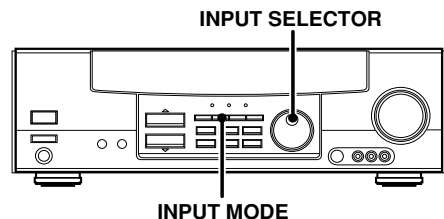

1 Use the **INPUT SELECTOR** knob to select **CD/DVD, VIDEO2, DVD/6ch or DVD (VR-505/KRF-V5550D only)**.

2 Press the **INPUT MODE** key.

Each press switches the setting as follows:

In DTS play mode

- 1 **D-AUTO** (digital input, auto sound)
- 2 **D-MANUAL** (digital input, manual sound)

In DVD/6ch or DVD play mode

- 1 **D-AUTO** (digital input, auto sound)
- 2 **D-MANUAL** (digital input, manual sound)
- 3 **6ch INPT** (DVD/6ch input)(except for VR-505/KRF-V5550D)
- 4 **ANALOG** (analog input, manual sound)

In modes other than DTS or DVD play mode

- 1 **D-AUTO** (digital input, auto sound)
- 2 **D-MANUAL** (digital input, manual sound)
- 3 **ANALOG** (analog input, manual sound)

Digital input:

Select this setting to play digital signals from a DVD, CD, or LD player.

Analog input:

Select this setting to play analog signals from a cassette deck, VCR, or record player.

Auto sound:

In the auto sound mode (**AUTO SOUND** indicator lights), the receiver selects the listening mode automatically during playback to match the type of input signal (Dolby Digital, PCM, DTS) and the speaker setting. The initial factory setting is auto sound on.

To keep the receiver set to the currently selected listening mode, use the **INPUT MODE** key to select "**D-MANUAL**" (manual sound). However, even when this setting is selected, there may be cases in which the listening mode is selected automatically to match a Dolby Digital source signal depending on the combination of listening mode and source signal.

If the **INPUT MODE** key is pressed quickly, sound may not be produced.

10 Connecting audio components

Preparations

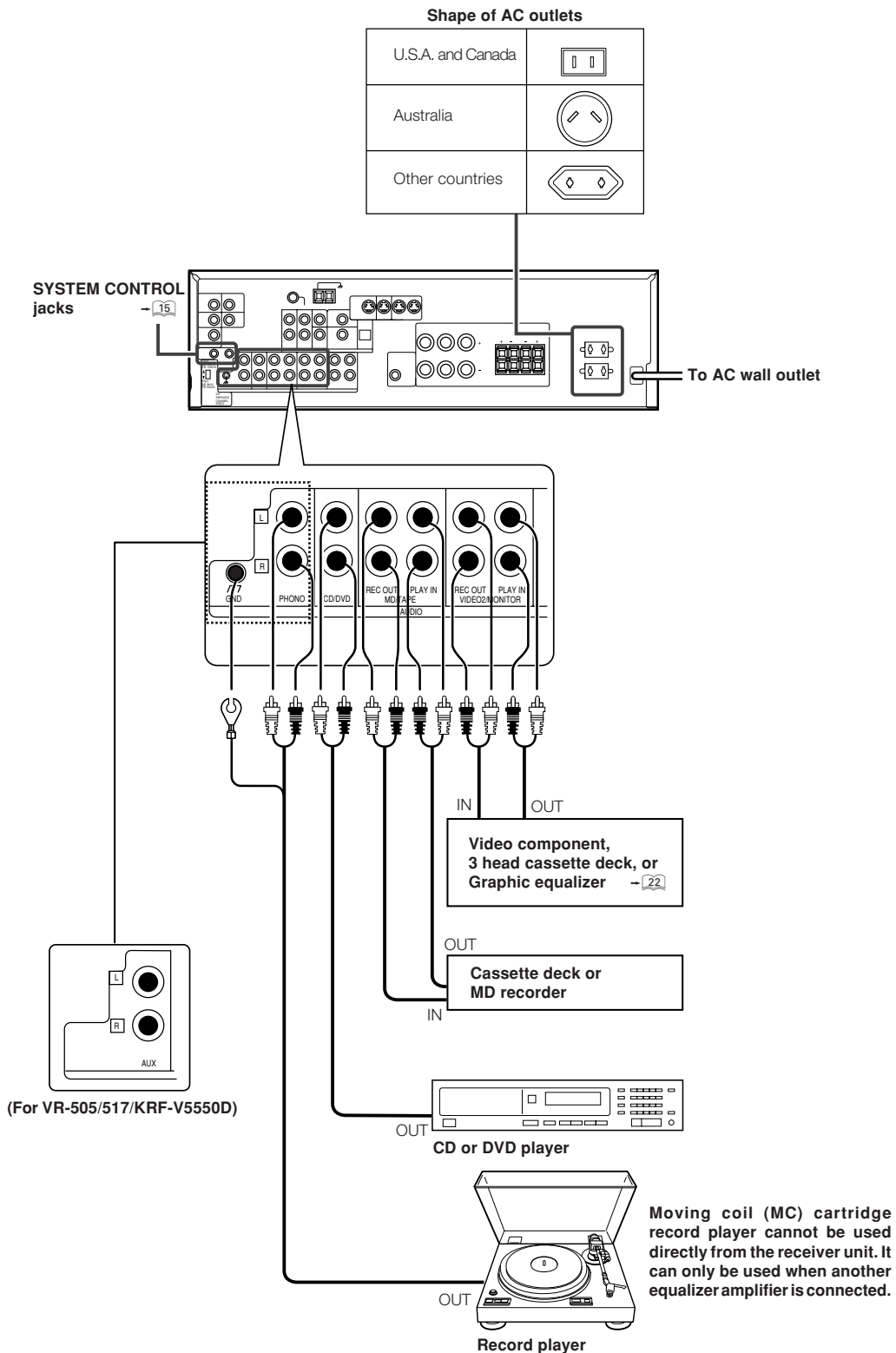

When you connect the audio cord of the video component to the VIDEO 2/MONITOR jacks, connect the video cord (yellow RCA pin cords) of the connected component to the VIDEO 2 IN jack.

Connecting video components

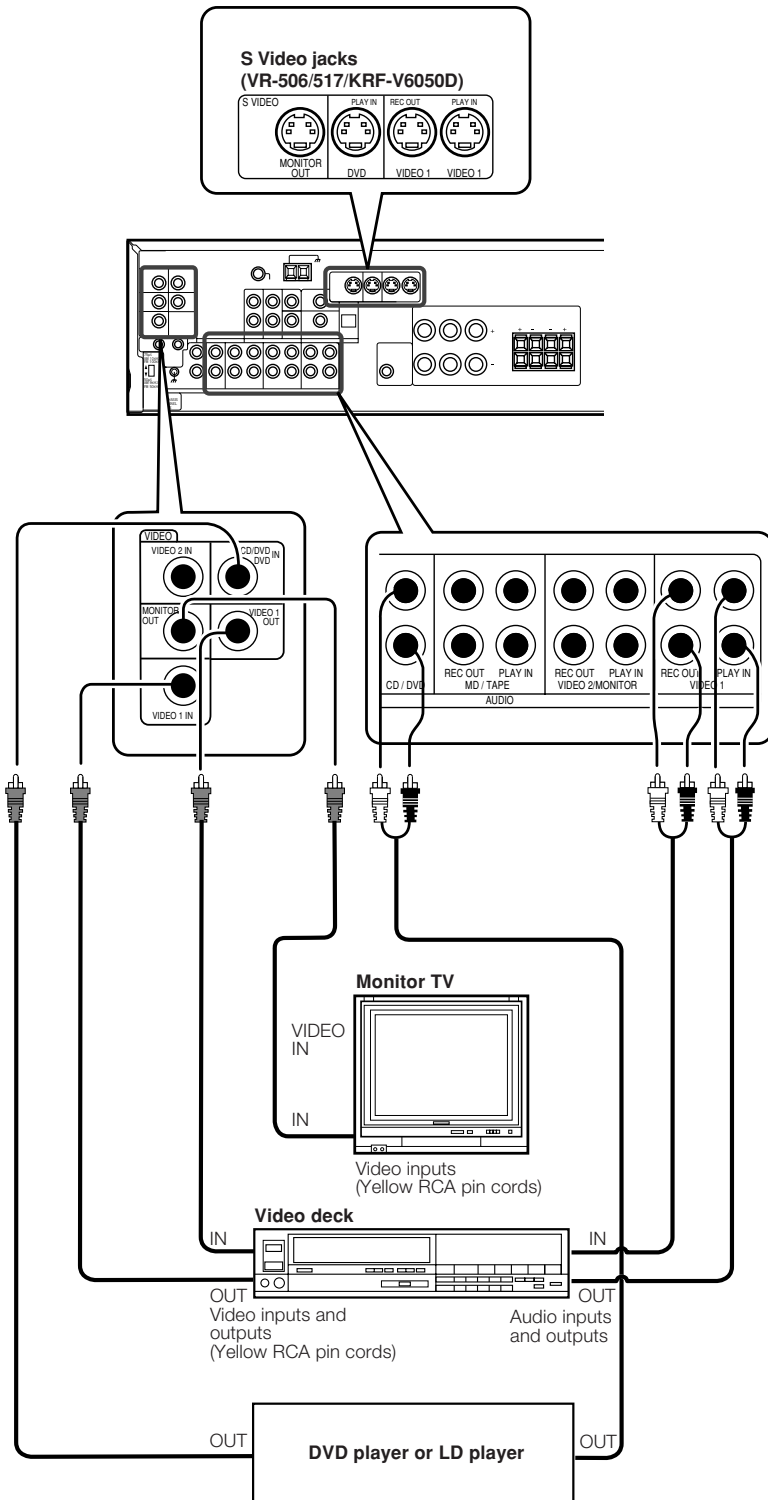

About the S VIDEO jacks

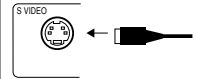

Use the S VIDEO jacks to make connections to video components with S VIDEO IN/OUT jacks.

- If you use the S VIDEO jacks to connect your video playback components, be sure to use the S VIDEO jacks when connecting your monitor and video recording components.

A video component with digital audio outputs should be connected to the VIDEO2 jacks.

Connecting a DVD player (6-channel input)

If you have connected a DVD player to the receiver with digital connection, be sure to read the "Input mode settings" section carefully.

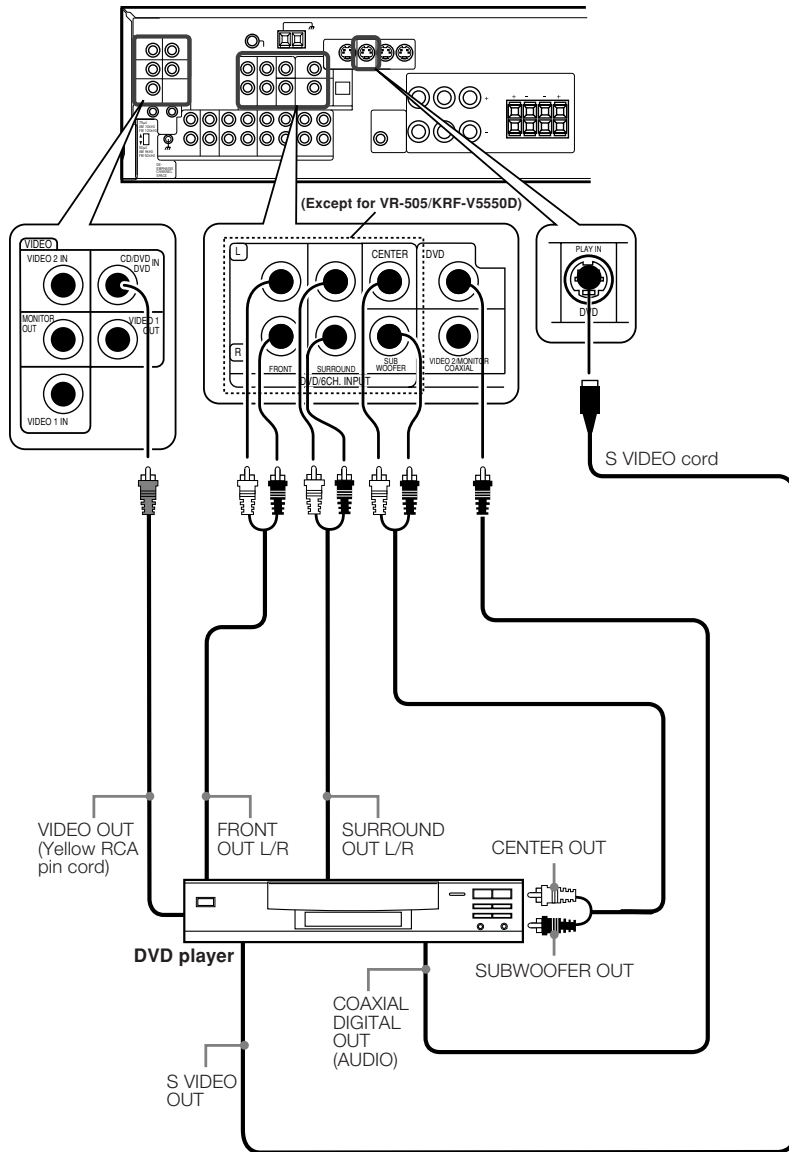

To switch the speakers off , press the MUTE key.

CAUTION (Except for U.S.A. and Canada)

Be sure to adhere followings. Or proper ventilation will be blocked causing damage or fire hazard.

- Do not place any objects impairing heat radiation onto the top of unit.
- Leave a space around the unit (from the largest outside dimension including projection) equal or greater than, shown below.

Top panel : 50 cm Side panel : 10 cm Back panel : 10 cm

CAUTION (For U.S.A. and Canada)

Be sure to adhere followings. Or proper ventilation will be blocked causing damage or fire hazard.

- Do not place any objects impairing heat radiation onto the top of unit.

Digital connections

The digital in jacks can accept DTS, Dolby Digital, or PCM signals. Connect components capable of outputting DTS, Dolby Digital, or standard PCM (CD) format digital signals.

If you have connected any digital components to the receiver, be sure to read the "Input mode settings" section carefully. 

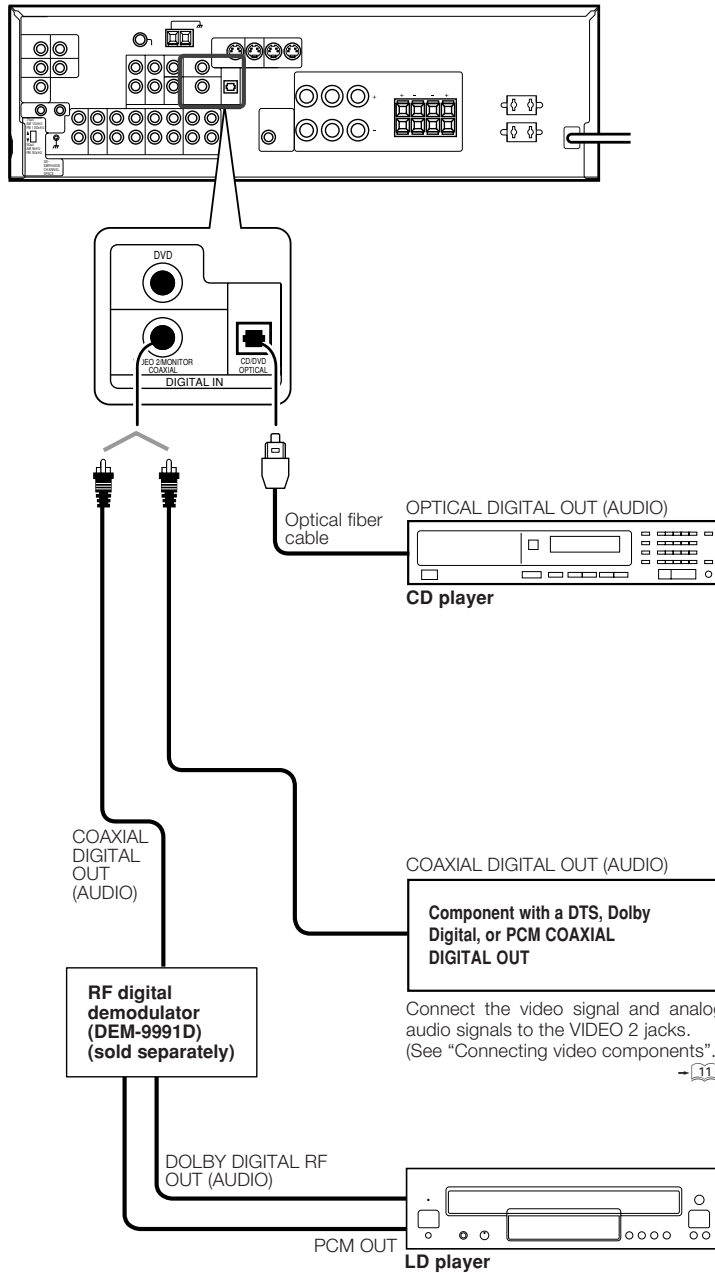

COAXIAL DIGITAL OUT (AUDIO)

Component with a DTS, Dolby Digital, or PCM COAXIAL DIGITAL OUT

Connect the video signal and analog audio signals to the VIDEO 2 jacks. (See "Connecting video components".) 

To connect an LD player with a DIGITAL RF OUT, connect the LD player to the KENWOOD RF digital demodulator (DEM-9991D). Next, connect the DIGITAL OUT jacks of the demodulator to the DIGITAL IN jacks of the receiver. Connect the video signal and analog audio signals to the VIDEO 2/MONITOR jacks. (See "Connecting video components".)

Connecting to the AV AUX jacks (VR-506/517/KRF-V6050D only)

The **AV AUX** jacks are convenient for connection of video components such as a camcorder or a video game.

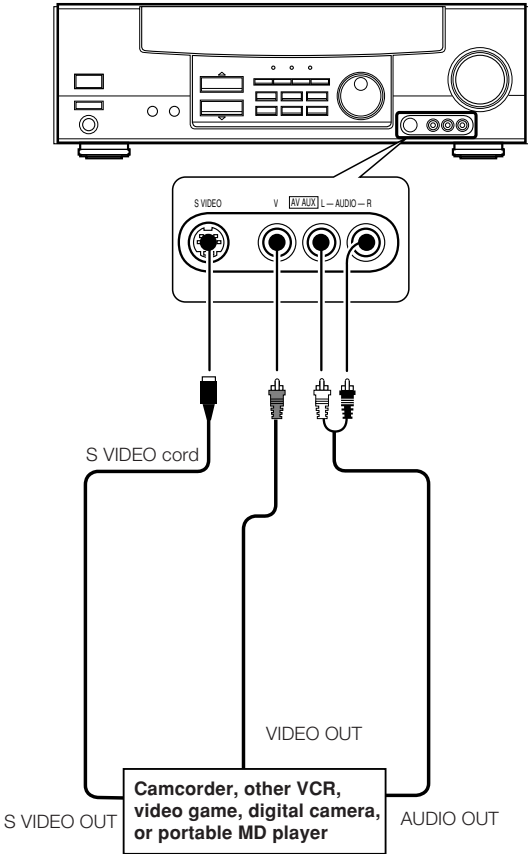

- To select the source connected to the AV AUX jacks, select **AV AUX** by using the **INPUT SELECTOR** knob. - 21
- When you connect the audio source such as the MD player, you do not need to connect the video cable.
- When you connect the unit and the component with the **S VIDEO** cord, you can get better picture quality.

Connecting the antennas

AM loop antenna

The supplied loop antenna is for use indoors. Place it as far as possible from the receiver, TV set, speaker cords and power cord, and adjust the direction for best reception.

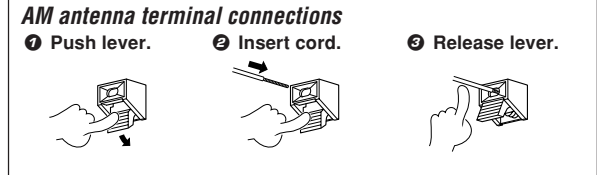

FM indoor antenna

The supplied indoor antenna is for temporary use only. For stable signal reception we recommend using an outdoor antenna. Disconnect the indoor antenna when you connect one outdoors.



FM outdoor antenna

Lead the 75Ω coaxial cable connected to the FM outdoor antenna into the room and connect it to the **FM 75Ω** terminal.

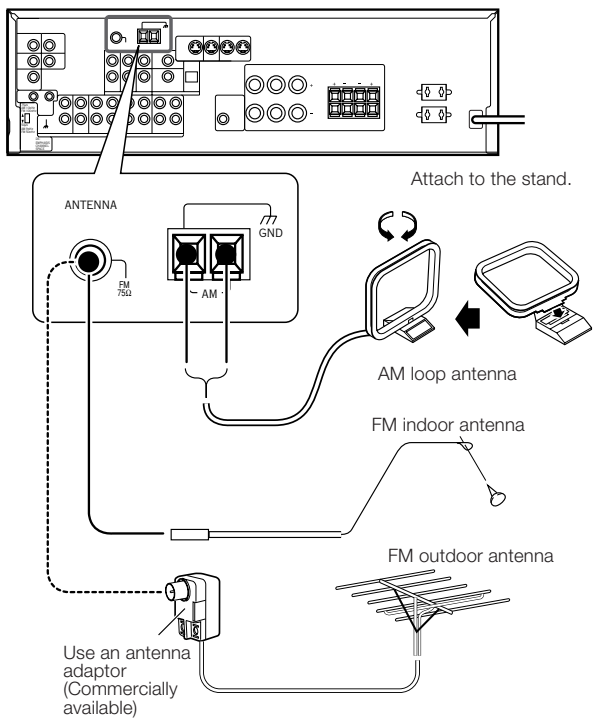

Connecting the system control

Connecting system control cords after connecting a KENWOOD audio component system lets you take advantage of convenient system control operations.

This unit is compatible only with the [SL16] mode. The system control operation is not available if the unit is connected in the [XS8], [XS], or [XR] connection mode.

If your component has the mode select switch, set the connected components to the [SL16] mode.

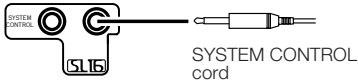

- You may connect the system control cord to either the left or right jack.

EXAMPLE: [SL16] mode connections

The underlined portion represents the setting of the system control mode.

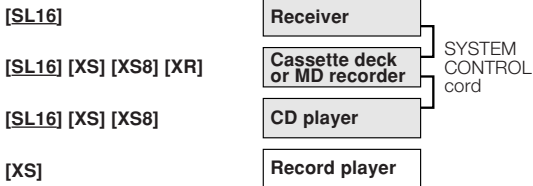

- In order to take advantage of the system control operations, the components must be connected to the correct jacks. To use a CD player it must be connected to the CD jacks. To use a cassette deck (or MD recorder) it must be connected to the MD/TAPE jacks. When using more than one CD player (etc.) only the one connected to the specified jacks may be connected for system control.
- Some CD players and cassette decks are not compatible with the [SL16] system control mode. Do not make system connections with equipment that is not [SL16] compatible.
- Some MD players are not system control compatible. You cannot make system control connections to this kind of equipment.

Notes

- [SL16] equipment cannot be combined with [XR], [XS], and [XS8] equipment for system operations. If your equipment consists of this kind of combination, please do not connect any system control cords. Even without system control cords, normal operations can be carried out without effecting performance.
- Do not connect system control cords to any components other than those specified by KENWOOD. It may cause a malfunction and damage your equipment.
- Be sure the system control plugs are inserted all the way in to the system control terminals.

SYSTEM CONTROL OPERATIONS

Remote Control

Lets you operate this unit with the system remote supplied with the receiver.

Automatic Operation

When you start playback from a source component, the input selector on this unit switches to that component automatically.

Synchronized Recording

Lets you synchronize recording with the start of playback when recording from CD, MD or analog discs.

Registering setup codes for KENWOOD audio components (VR-506/517/KRF-V6050D/V5550D)

- If you own remote controllable KENWOOD audio components that are not compatible with system control, registering the setup code enables you to control those components using the remote control supplied with this unit (without connecting system control cords). To register setup codes for your remote controllable KENWOOD audio components, see "Registering setup codes for other components".

→ 30

Do not connect a system control cord to a cassette deck connected to the VIDEO2/MONITOR jacks.

Connecting the speakers

16

Preparations

1 Strip coating.



2 Loosen.



3 Insert.

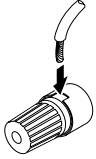

4 Secure.



Connection of banana plugs (For U.S.A. and Canada)

1 Secure.



2 Insert.

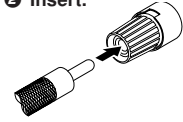

• Sound will not be heard if the speaker terminal is not fully secured.

- Never short circuit the + and – speaker cords.
- If the left and right speakers are connected inversely or the speaker cords are connected with reversed polarity, the sound will be unnatural with ambiguous acoustic imaging. Be sure to connect the speakers correctly.

1 Strip coating.



2 Push the lever.

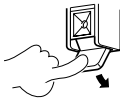

3 Insert the cord.

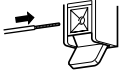

4 Return the lever.

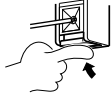

Speaker impedance

After confirming the speaker impedance indications printed on the rear panel of the receiver, connect speakers with matching impedance ratings. Using speakers with a rated impedance other than that indicated on the rear panel of the receiver could result in malfunctions or damage to the speakers or receiver.

Connecting the speakers

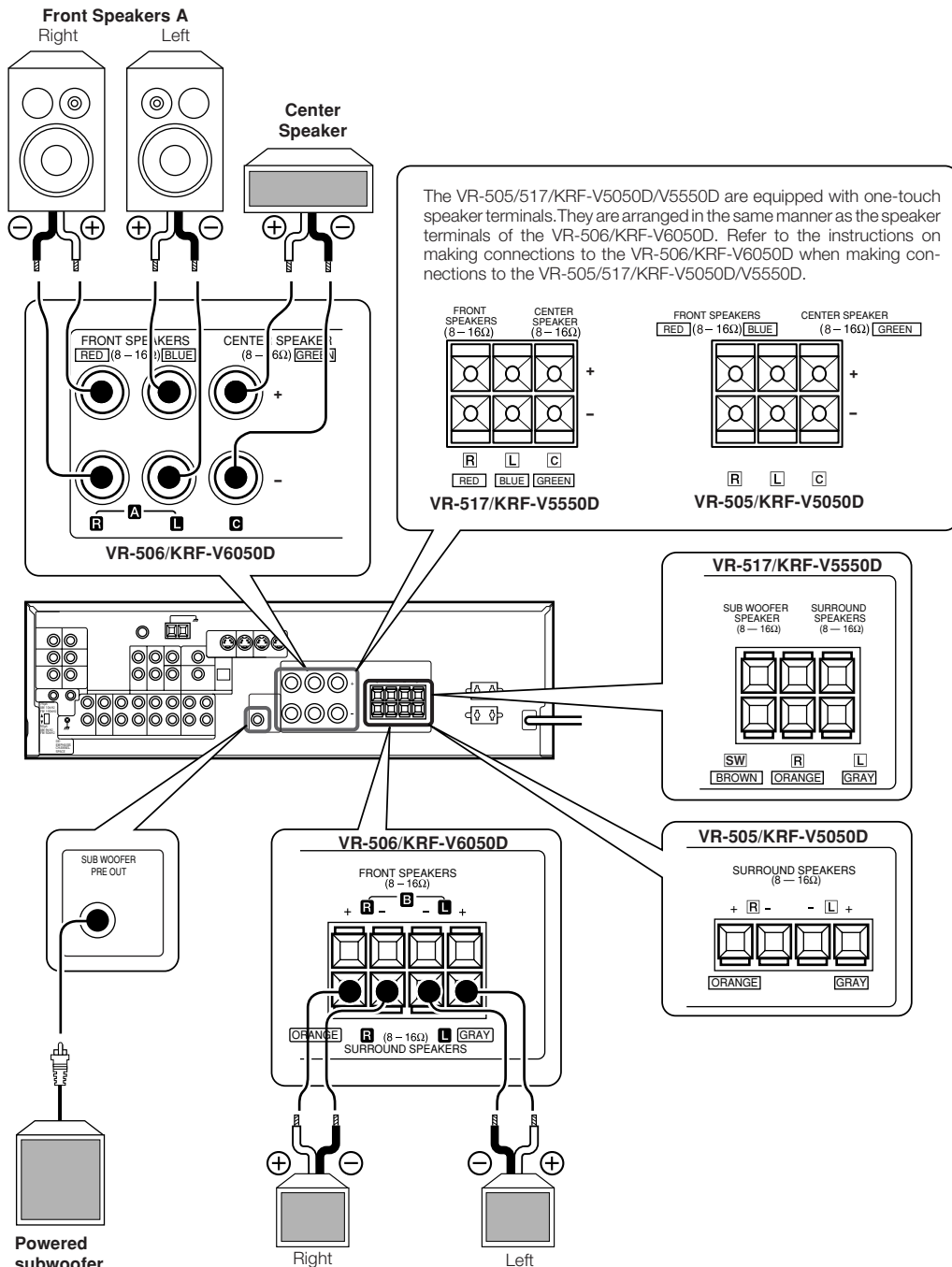

The VR-505/517/KRF-V5050D/V5550D are equipped with one-touch speaker terminals. They are arranged in the same manner as the speaker terminals of the VR-506/KRF-V6050D. Refer to the instructions on making connections to the VR-506/KRF-V6050D when making connections to the VR-505/517/KRF-V5050D/V5550D.

(Except VR-517/KRF-V5550D)

Surround Speakers
(Be sure to connect both surround speakers)

Use the FRONT SPEAKERS B terminals if you want to connect a second front speaker system (for VR-506/KRF-V6050D).

Speaker placement

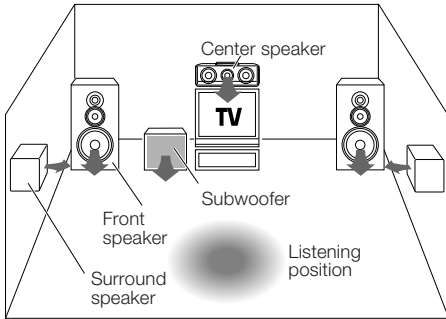

Front speakers : Place to the front left and right of the listening position. Front speakers are required for all surround modes.

Center speaker : Place front and center. This speaker stabilizes the sound image and helps recreate sound motion. Be sure to connect a center speaker when using the Dolby 3 Stereo mode.

Surround speakers : Place to the direct left and right, or slightly behind, the listening position at even heights, approximately 1 meter above the ears of the listeners. These speakers recreate sound motion and atmosphere. Required for surround playback.

Subwoofer : Reproduces powerful deep bass sounds.

- Although the ideal surround system consists of all the speakers listed above, if you don't have a center speaker or a subwoofer, you can divide those signals between the available speakers in the speaker settings steps to obtain the best possible surround reproduction from the speakers you have available.



Preparing the remote control

Loading the batteries

❶ Remove the cover.

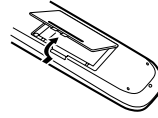

❷ Insert the batteries.

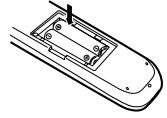

❸ Close the cover.

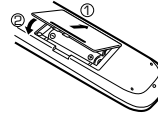

- Insert two AA-size (R6) batteries as indicated by the polarity markings.

Operation

When the **STANDBY** indicator is lit, the power turns ON when you press the **POWER** key on the remote control. When the power comes ON, press the key you want to operate.

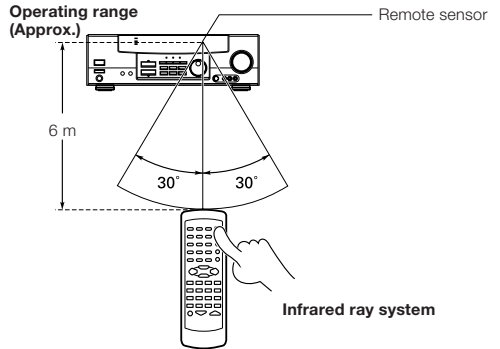

- When pressing more than one remote control key successively, press the keys securely by leaving an interval of 1 second or more between keys.

Channel space switching

(Except for the USA, Canada, UK, Europe, and Australia)

The space between radio channels has been set to the one that prevails in the area to which the system is shipped. However, if the current channel space setting does not match the setting in the area where the system is to be used, for instance when you move from area 1 or area 2 shown in the following table or vice versa, proper reception of AM/FM broadcasts cannot be expected. In this case, change the channel space setting in accordance with your area by referring to the following table.

Area	CHANNEL Space Frequency
1 USA, Canada and South American countries	FM: 100 kHz AM: 10 kHz
2 Other countries	FM: 50 kHz AM: 9 kHz

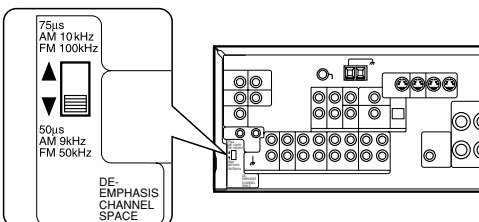

Move switch lever to match your area with a small screwdriver or other pointed tool.

Notes

1. The supplied batteries may have shorter lives than ordinary batteries due to use during operation checks.
2. When the remote-controllable distance gets shorter than before, replace both batteries with new ones.
3. Placing the remote sensor in direct sunlight, or in direct light from a high frequency fluorescent lamp may cause a malfunction. In such a case, change the location of the system installation to prevent malfunction.

Speaker settings

To enable you to obtain optimum enjoyment from the receiver's listening modes, make sure to complete the speaker settings (subwoofer, front, center, and surround speakers) as described below.

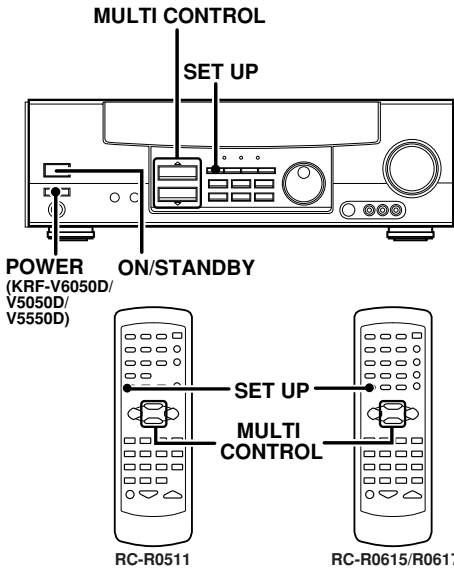

1 Turn on the power to this receiver by pressing **POWER** or **ON/STANDBY** key(s).

2 Select a speaker system.

1 Press the **SET UP** key such that the subwoofer setting indication (**SUBW ON**) appears.



2 Use the **MULTI CONTROL** keys to select the appropriate subwoofer setting.

- ➔ **1 SUBW ON:** Subwoofer setting mode to the receiver is ON.
- ➔ **2 SUBW OFF:** Subwoofer setting mode to the receiver is OFF.

- The initial setting is "SUBW ON".
- When the setting "SUBW OFF" is selected, the front speakers are automatically set to "FRNT LRG" and the procedure skips to step **5**.
- When subwoofer output sound is required, select "FRNT NML".

3 Press the **SET UP** key to accept the setting.

- The front speakers setting indication (**FRNT**) appears.



4 Use the **MULTI CONTROL** keys to select the appropriate front speakers setting.

- ➔ **1 FRNT NML (normal):** Average size front speakers are connected to the receiver.
- ➔ **2 FRNT LRG (large):** Large front speakers are connected to the receiver.

- For "FRNT LRG" selection, no sound will be heard from SUBW even when it is set to ON. However, if you select CINEMA EQ. when subwoofer is selected, you will be able to hear sound from the subwoofer.
- When in STEREO mode, the sound goes directly to front speaker.

5 Press the **SET UP** key to accept the setting.

- The center speaker setting indication (**CNTR**) appears.

6 Use the **MULTI CONTROL** keys to select the appropriate center speaker setting.

If you selected "LRG" as the front speakers setting,

- ➔ **1 CNTR LRG (large):** A large center speaker is connected to the receiver.
- ➔ **2 CNTR NML (normal):** An average size center speaker is connected to the receiver.
- ➔ **3 CNTR OFF:** Center speaker setting mode to the receiver is OFF.

If you have selected "NML" as the front speakers setting,

- ➔ **1 CNTR ON:** Center speaker setting mode to the receiver is ON.
- ➔ **2 CNTR OFF:** Center speaker setting mode to the receiver is OFF.

7 Press the **SET UP** key again to accept the setting.

- The surround speaker setting indication (**SURR**) appears.

8 Use the **MULTI CONTROL** keys to select the appropriate surround speaker setting.

If you selected "LRG" as the center speaker setting,

- ➔ **1 SURR LRG (large):** Large surround speakers are connected to the receiver.
- ➔ **2 SURR NML (normal):** Average size surround speakers are connected to the receiver.
- ➔ **3 SURR OFF:** Surround speaker setting mode to the receiver is OFF.

If you have selected other than "LRG" as the center speaker setting,

- ➔ **1 SURR ON:** Surround speaker setting mode to the receiver is ON.
- ➔ **2 SURR OFF:** Surround speaker setting mode to the receiver is OFF.

9 Press the **SET UP** key again to accept the setting.

- The receiver enters the speaker volume level adjustment mode.
- In steps **8** and **9**, indications appear only for the selected channels of the speakers that require adjusting.

3 Adjust the speaker volume.

From your usual listening position, adjust the volume levels. The volume levels from each speaker should be the same.

1 Use the **MULTI CONTROL** keys to adjust the volume of the test tone output from the speaker channel to be adjusted.

The channel indication blinks while the test tone is being output.



The test tone is heard from the speakers in the following sequence for 2 seconds each:

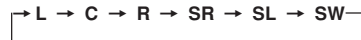

- If you change the volume level settings for the speakers while listening to music, the settings referred to on this page are also changed.

- If the speaker setting selects are changed, the speaker level settings are reset.

2 Press the **SET UP** key.

- The test tone is turned off. The receiver enters the mode for inputting the distance to the speakers.

4 Input the distance to the speakers.

- Measure the distance from the listening position to each of the speakers.

Jot down the distance to each of the speakers.

Distance to front speakers: ___ feet ___ meters
 Distance to center speaker: ___ feet ___ meters
 Distance to surround speakers: ___ feet ___ meters

- Use the **MULTI CONTROL** keys to select the distance to the front speakers.

The speaker indicator to be adjusted blinks.

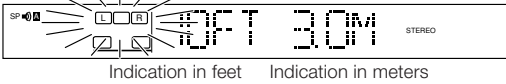

- The allowable setting range is 1 to 30 feet (0.3 to 9.0 m), adjustable in 1 foot (0.3 m) increments.

- Press the **SET UP** key to accept the settings.
- Repeat steps 2 and 3 to input the distance for each of the speakers.

- Setup is complete when the input indication reappears.



Display when all speakers have been selected.

- The speakers you have selected should appear on the display. Confirm that all the speakers have been correctly selected.

Input level adjustment (analog sources only)

If the input level of an analog source signal is too high, adjust the input level. The CLIP indicator will blink to indicate the source signal.

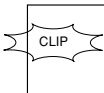

- Use the **INPUT SELECTOR** knob to select the source which input level you want to adjust.

- You can store a separate input level for each input source. If the **MONITOR** function is ON, you can store an input level for when **MONITOR** is on independently of the input levels for the input sources.

- Press the **SOUND** key repeatedly until the "INPUT" indication appears.

- Use the **MULTI CONTROL** keys to adjust the input level.



- The adjustment mode is displayed for approximately eight seconds.
- The input level may be adjusted to any one of three settings: 0dB, -3dB, and -6dB. (The initial setting is 0dB.)

- Press the **SOUND** key again to return to the input indication.

Normal playback

Preparing for playback

Some preparatory steps are needed before starting playback.

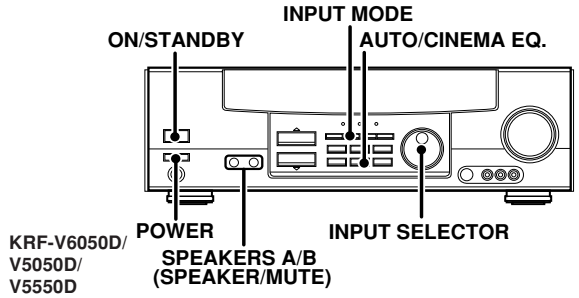

Selecting the input mode

If you have selected a component connected to the **CD/DVD**, **DVD/6ch**, **DVD (VR-505/KRF-V5550D only)** or **VIDEO2/MONITOR** jacks, make sure that the input mode setting is correct for the type of audio signal to be used.

Selecting MD/TAPE

Select the source name corresponding to the component connected to the MD/TAPE jacks. The initial factory setting is "TAPE". To change the source to "MD," follow the steps below:

- Use the **INPUT SELECTOR** knob to select "TAPE".
- Hold down the **AUTO/CINEMA EQ.** key for more than 2 seconds.
 - The source indication changes to "MD".
 - To return to the original indication, repeat procedure 1.

Selecting the speaker system (VR-506/KRF-V6050D only)

Press the **SPEAKERS A** or **B** key to select the speaker system to be used.

- A ON** : Sound from the speakers connected to the **SPEAKERS A** terminals on the rear panel.
- B ON** : Sound from the speakers connected to the **SPEAKERS B** terminals on the rear panel.
- A+B ON** : Sound from both the speakers connected to the **SPEAKERS A and B** terminals on the rear panel.
- A+B OFF** : No sound from the speakers. Use this setting when listening with headphones for stereo sound in all playback modes.

The indicator for the speakers you want to use should be lit.

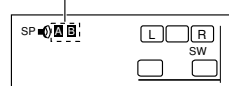

VR-506/KRF-V6050D

The speaker indicator lights.

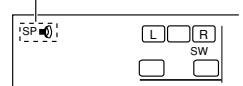

VR-505/517/KRF-V5050D/V5550D

- Selecting "6ch INPT" by pressing the **INPUT MODE** key, whereby "DVD/6ch" is the input source will cause **SPEAKER A** to be selected automatically.

On the VR-505/517/KRF-V5050D/V5550D, press the **SPEAKER** key to switch the speakers on and off.

Turning on the receiver

- Turn on the power to the related components.
- Turn on the power to this receiver by pressing **POWER** (and **ON/STANDBY**) key(s).

Listening to a source component

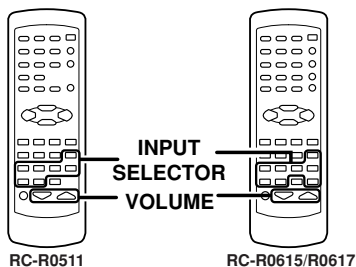
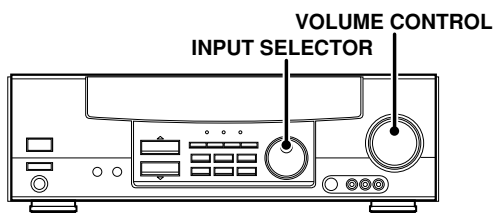

- 1** Use the **INPUT SELECTOR** knob to select the source you want to listen to.

The input sources change as shown below:
Selecting a source using the **INPUT SELECTOR** knob.

VR-506/KRF-V6050D

- ① "PHONO"
- ② "TUNER"
- ③ "CD/DVD"
- ④ "TAPE" or "MD"
- ⑤ "VIDEO1"
- if VIDEO2/MONITOR is VIDEO2
- ⑥ "VIDEO2"
- ⑦ "DVD/6ch"
- ⑧ "AV AUX"
- else if VIDEO2/MONITOR is MONITOR
- ⑥ "DVD/6ch"
- ⑦ "AV AUX"

KRF-V5050D

- ① "PHONO"
- ② "TUNER"
- ③ "CD/DVD"
- ④ "TAPE" or "MD"
- ⑤ "VIDEO1"
- if VIDEO2/MONITOR is VIDEO2
- ⑥ "VIDEO2"
- ⑦ "DVD/6ch"
- else if VIDEO2/MONITOR is MONITOR
- ⑥ "DVD/6ch"

VR-505

- ① "AUX"
- ② "TUNER"
- ③ "CD/DVD"
- ④ "TAPE" or "MD"
- ⑤ "VIDEO1"
- if VIDEO2/MONITOR is VIDEO2
- ⑥ "VIDEO2"
- ⑦ "DVD"
- else if VIDEO2/MONITOR is MONITOR
- ⑥ "DVD"

VR-517/KRF-V5550D

- ① "AUX"
- ② "TUNER"
- ③ "CD/DVD"
- ④ "TAPE" or "MD"
- ⑤ "VIDEO1"
- if VIDEO2/MONITOR is VIDEO2
- ⑥ "VIDEO2"
- ⑦ "DVD/6ch"
- ⑧ "AV AUX" (VR-517 only)
- else if VIDEO2/MONITOR is MONITOR
- ⑥ "DVD/6ch"
- ⑦ "AV AUX" (VR-517 only)

- 2** Start playback from the selected source.

- 3** Use the **VOLUME CONTROL** knob (**VOLUME** keys) to adjust the volume.

Selecting VIDEO 2/MONITOR

Depending on the component connected to the **VIDEO 2/MONITOR** jacks, select either the "VIDEO 2" setting or the "MONITOR" setting, as appropriate.

Adjusting the sound

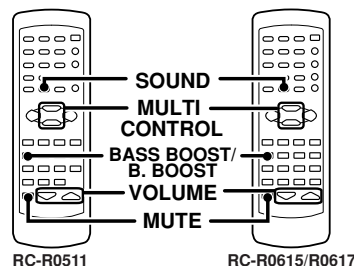
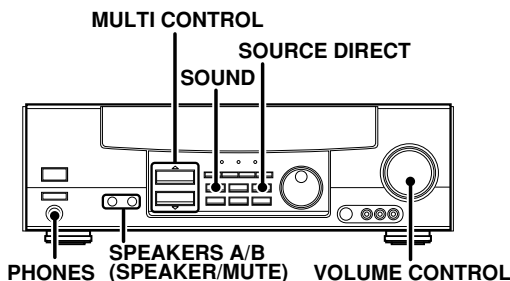

Adjusting the tone

You can adjust the sound quality when the receiver is in the PCM stereo and analog stereo mode.

- 1** Press the **SOUND** key to select the tone mode to be adjusted.

BASS: Select this to adjust the low frequency range.
(Press the **SOUND** key once.)

TREB: Select this to adjust the high frequency range.
(Press the **SOUND** key twice.)



- 2** Use the **MULTI CONTROL** keys to adjust the sound quality.

- The bass and treble levels are adjustable from -10dB to +10dB in 2 step increments.
- The adjustment item is displayed for approximately 8 seconds.

Once-touch low frequency emphasis (bass boost) (remote control only)

You can adjust the sound quality when the receiver is in the PCM stereo and analog stereo modes.

Press the **B. BOOST (BASS BOOST)** key.

- Press the key once to select the maximum (+10dB) low frequency emphasis setting.
- This key does not function when the receiver is in the sound quality or ambience effects adjustment mode.

Switching back to the previous setting

Press the **B. BOOST (BASS BOOST)** key again.

Muting the sound

The **MUTE** key lets you mute the sound of the speakers.

Press the **MUTE** key.

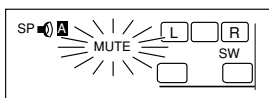

Blinks

To cancel

Press the **MUTE** key again so that the “**MUTE**” indicator goes off.

- **MUTE ON** can also be deactivated by turning the volume control knob.

SOURCE DIRECT playback (for analog input sources only)

Use this function to pass the source material direct to the amplifier, bypassing any audio processing.

Press the **SOURCE DIRECT** key.

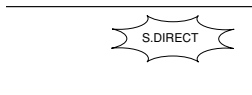

- When you press the **LISTEN MODE**, **SOUND**, or **SET UP** keys, or switch to another input source, **SOURCE DIRECT** playback will be canceled.
- If **CINEMA EQ.** is switched **ON**, **SOURCE DIRECT** key will not be effective.

To cancel

Press the **SOURCE DIRECT** key again.

- If **SOURCE DIRECT** playback was activated while in surround mode, canceling **SOURCE DIRECT** playback will reactivate the previous surround mode.

Listening with headphones

- 1 (VR-506/KRF-V6050D)
Press the **SPEAKERS A** or **B** key so that the speaker indicator goes off.

(VR-505/517/V5050D/V5550D)
Press the **SPEAKER** key so that the speaker indicator goes off.

Make sure the **SPEAKERS** indicators are turned off.

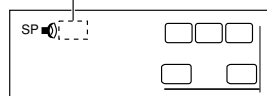

VR-506/KRF-V6050D

Make sure the **SP** indicators are turned off.

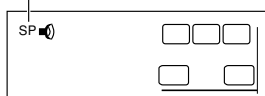

VR-505/517/KRF-V5050D/
V5550D

- If you turn off all of the speakers when in surround mode, the surround mode will be canceled as well, resulting in stereo playback.

- 2 Connect headphones to the **PHONES** jack.



- 3 Use the **VOLUME CONTROL** knob (**VOLUME** keys) to adjust the volume.

Recording

Recording audio (analog sources)

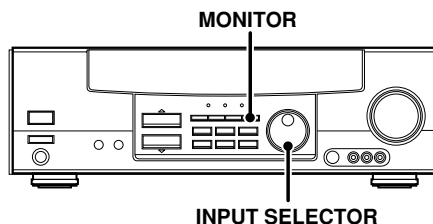

Recording a music source

When recording a music source, switch the **VIDEO2/MONITOR** setting to “**MONITOR**”.

- 1 Use the **INPUT SELECTOR** knob to select the source (other than “**TAPE**”) you want to record.
- 2 Set the cassette deck or MD recorder to record.
- 3 Start playback, then start recording.

Recording tapes or MD (with MONITOR function)

When recording a music source, switch the **VIDEO2/MONITOR** setting to “**MONITOR**”.

MONITOR → MD/TAPE recording

- 1 Press the **MONITOR** key.
- 
- 2 Use the **INPUT SELECTOR** knob to select a source other than “**MD/TAPE**”.
 - 3 Start playback on the cassette deck connected to the **MONITOR** jacks and start recording on the cassette deck or MD recorder connected to the **MD/TAPE** jacks.

MD/TAPE → MONITOR recording

- 1 Use the **INPUT SELECTOR** knob to select “**MD/TAPE**.”
 - 2 Start playback on the cassette deck connected to the **MD/TAPE** jacks and start recording on the cassette deck or MD recorder connected to the **VIDEO2/MONITOR** jacks.
- To copy tapes using a double cassette deck, refer to the instruction manual of the double cassette deck.

MONITOR function (analog sources only)

You can connect a cassette deck or graphic equalizer to the **VIDEO2/MONITOR** jacks of the receiver. If a graphic equalizer is connected, the **MONITOR** key should be left in the on position. Alternately, if a cassette deck equipped with a 3-head system is connected to the **VIDEO2/MONITOR** jacks, you will be able to monitor the just-recorded signal while making recordings on the cassette deck. By switching the **MONITOR** key on and off, you can compare the sound of the source signal and the just-recorded signal. For more information, refer to the instruction manual of the connected component.

Recording video

- ❶ Use the **INPUT SELECTOR** to select the video source (other than "VIDEO1") you want to record.
- ❷ Set the video deck connected to **VIDEO 1** to record.
 - Select the **REC MODE** to record a digital input source.
- ❸ Start playback, then start recording.
 - Recording may not be normal for some video software. This is due to the copy guard condition. — [39]

Recording audio (digital sources)

Switch on the **REC** mode to record a digital input source. Usually use the **A-REC (Auto-Record)** mode to record audio input sources. When the digital mode changes during recording in the **A-REC** mode, the audio input source may be interrupted momentarily.

Recording music in A-REC or M-REC mode

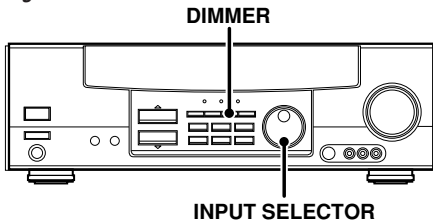

- ❶ Use the **INPUT SELECTOR** to select the source (CD, DVD or VIDEO2) you want to record.
- ❷ Set the cassette deck or MD recorder to record.
- ❸ Press and hold the **DIMMER** key for more than 2 seconds to select the **A-REC** or **M-REC** mode.
 - The mode changes every 2 seconds as shown below.

- | | |
|--|---|
| <ol style="list-style-type: none"> ❶ Rec mode off : ❷ A-REC : ❸ M-REC : | <p>The digital input record mode is switched off.</p> <p>The digital input signals (DTS, Dolby Digital, or PCM) are identified automatically and converted into stereo signals that are ready for recording.</p> <p>The input signal type at the moment this mode is selected is held throughout this mode.</p> |
|--|---|

For A-REC mode:

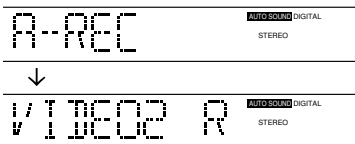

For M-REC mode:

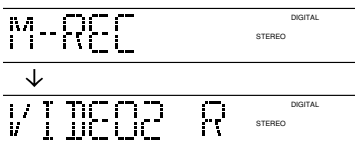

- ❹ Start playback, then start recording.
 - If the audio reproduction stops in the middle due to change in the input signals, etc., press the **DIMMER** key.

Listening to radio broadcasts

The receiver can store up to 40 stations in the memory and recall them by one-touch operation.

Tuning radio stations

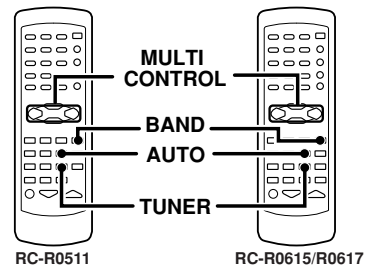
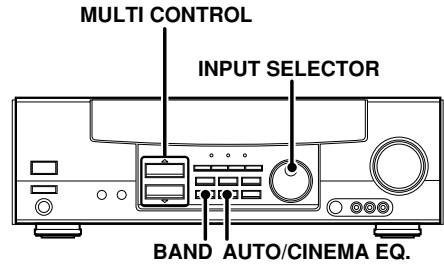

- ❶ Use the **INPUT SELECTOR knob (TUNER key)** to select the tuner.
- ❷ Use the **BAND key** to select the desired broadcast band.

Each press switches the band as follows:

- ❶ FM
- ❷ AM

"AM" or "FM" indicator appears in the display



- ❸ Use the **AUTO/CINEMA EQ. key** to select the desired tuning method.

Each press switches the tuning method as follows:

- ❶ **AUTO lit** (auto tuning)
- ❷ **AUTO not lit** (manual tuning)

"AUTO" indicator lights up in the display.

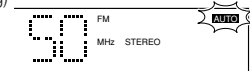

- Normally, set to "AUTO" (auto tuning). If the radio waves are weak and there is a lot of interference, switch to manual tuning. (With manual tuning, stereo broadcasts will be received in monaural.)

- ❹ Use the **MULTI CONTROL keys** to select the station.

Frequency display "ST." lights when a broadcast is being received in stereo.

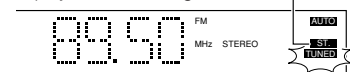

"TUNED" is displayed when a station is received.

- Auto tuning** : The next station is tuned automatically.
- Manual tuning** : Turn the knob (press the key) to select the desired station.

Presetting radio stations manually

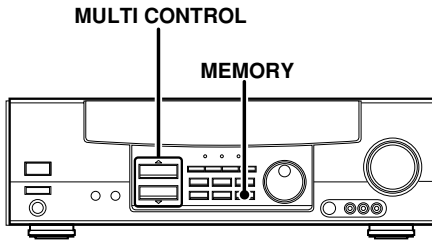

- 1 Tune to the station you want to store.
- 2 Press the **MEMORY** key while receiving the station.

Blinks for 5 seconds Lights for 5 seconds

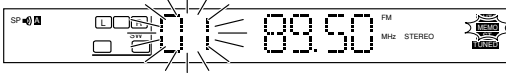

Proceed to step **3** within 5 seconds.
(If more than 5 seconds elapse, press the **MEMORY** key again).

- 3 Use the **MULTI CONTROL** keys to select one of the station presets (1 – 40).
- 4 Press the **MEMORY** key again to confirm the setting.

- Repeat steps **1**, **2**, **3**, and **4** to store as many stations as necessary.
- If you store a station at a previously used preset, the old station will be replaced by the new one.

Receiving preset stations

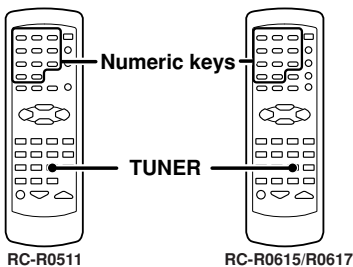

- 1 Press **TUNER** to select tuner as the source.
- 2 Enter the number of the preset station you want to receive (up to "40").

Press the numeric keys in the following order:

For "15", press **+10**, **5**
For "20", press **+10**, **+10**, **0**

- If you make a mistake entering a two digit number, press the **+10** key repeatedly to return to the original display and start again.

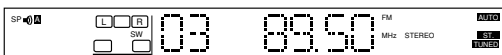

Receiving preset stations in order (P.CALL)

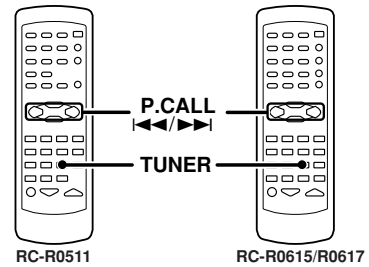

- 1 Press **TUNER** key to select the tuner as the source.
- 2 Use the **P.CALL** **◀◀/▶▶** key to select the desired station.

- Each time you press the key, another preset station is received in order.

Pressing the **P.CALL** **▶▶** does the following:

→01→02→03→ ... → ... 38→39→40

Pressing the **P.CALL** **◀◀** does the following:

01←02←03← ... ← ... 38←39←40←

Holding down the **▶▶** or **◀◀** key, lets you skip through the presets, receiving each preset station at 0.5 second intervals.

Ambience effects

This receiver is equipped with listening modes that allow you to enjoy an enhanced sonic ambience with a variety of video sources.

In order to obtain the optimum effect from the surround modes, make sure to input the proper speaker settings beforehand. → [19]

Surround modes

DTS

The DTS multi-channel audio format is available on CD, LD and DVD software. DTS is a strictly digital format and can not be decoded inside most CD, LD or DVD players. For this reason, if you attempt to listen to DTS encoded software through the analog output of your new CD, LD or DVD player, you will experience digital noise in most cases. This noise can be quite loud if the analog output is connected directly to a high power amplification system. Proper measures for playing the digital output as described below should be taken to avoid this situation. To enjoy DTS Digital Surround playback, an external 5.1 channel DTS Digital Surround decoder system or an amplifier with a built-in DTS Digital Surround decoder must be connected to the digital output (S/P DIF, AES/EBU or TosLink) of a CD, LD or DVD player. All models are incorporated with the DTS decoder.

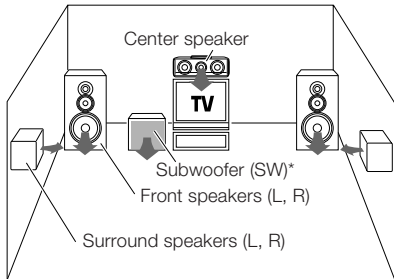

* Optional in this mode.

* LFE = Low Frequency Effects. This channel delivers separate non-directional bass signals to the subwoofer for more dynamic deep bass sound effects. DTS has a .1 or LFE channel. The indication "LFE" appears in the display when a signal is being input for this channel.

Manufactured under license from Digital Theater Systems, Inc. US Pat. No. 5,451,942 and other worldwide patents issued and pending. "DTS" and "DTS Digital Surround" are trademarks of Digital Theater Systems, Inc. © 1996 Digital Theater Systems, Inc. All rights reserved.



Manufactured under license from Dolby Laboratories. Dolby, Pro Logic and the double-D symbol are trademarks of Dolby Laboratories. Confidential Unpublished Works. ©1992-1997 Dolby Laboratories. All rights reserved.

Dolby Digital

The Dolby Digital surround format lets you enjoy up to 5.1 channels of digital surround sound from Dolby Digital program sources (such as Laserdisc or DVD software marked ). Compared with previous Dolby surround, Dolby Digital provides even better sound quality, greater spatial accuracy, and improved dynamic range.

Note

Although a full set of speakers (front left, right, and center, surround left and right, and a subwoofer) is required for true 5.1 channel Dolby Digital surround sound, this receiver lets you enjoy Dolby Digital (and Dolby Surround) program sources, even if you connect only the front speakers.

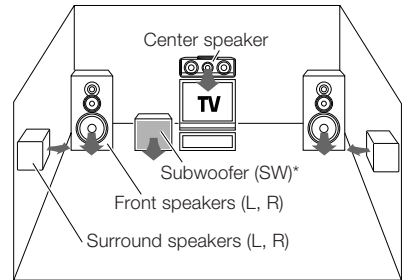

* LFE = Low Frequency Effects. This channel delivers separate non-directional bass signals to the subwoofer for more dynamic deep bass sound effects.

Although only Dolby Digital soundtracks incorporate a separate low frequency channel, connecting a subwoofer will also improve deep bass performance in the other surround modes.

The indication "LFE" appears in the display when a signal is being input for this channel.

Dolby Pro Logic

Dolby Pro Logic is a specially encoded 2 channel surround format designed to provide theater-like surround sound from Dolby Surround encoded sources (such as video and Laserdisc software marked ). This receiver is equipped with a Dolby Pro Logic surround decoder to let you enjoy the wide variety of currently available Dolby Surround home video software. Surround signal is monaural.

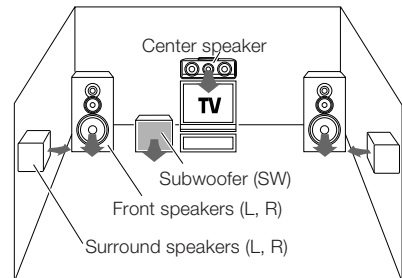

Dolby 3 Stereo

Dolby 3 Stereo is available for systems that do not have surround speakers. When in the Dolby 3 Stereo mode, the surround information is redirected to the front left and right speakers. This mode is designed for use with Dolby Surround program sources, but can also improve sound field unity for programs that are not Dolby Surround encoded. Dialog positioning and sound image definition, however, may not be as accurate when used with programs that are not Dolby Surround encoded.

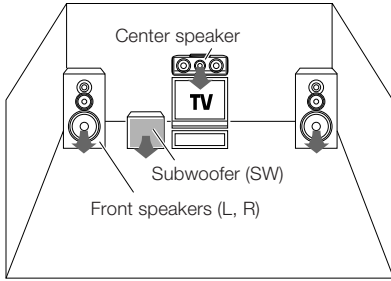

DSP mode

The DSP mode lets you add the atmosphere of a live concert or hall to almost any type of program source. These modes are particularly effective when used with stereo program sources, like CD, television, and FM radio. You might enjoy trying the ARENA, JAZZ CLUB, THEATER, STADIUM or DISCO mode the next time you watch a concert or sporting event!

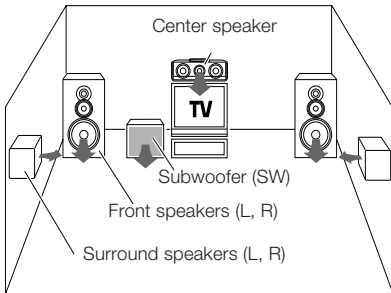

What's DSP?

DSP stands for Digital Signal Processor. The way a sound is heard in an actual environment depends on a variety of different factors. One of the most important is reverberation (the act of decaying elements of sound echoing in various places). The DSP modes produce the feeling of presence by using the DSP to create reverberation, without spoiling the sound quality of the original signal.

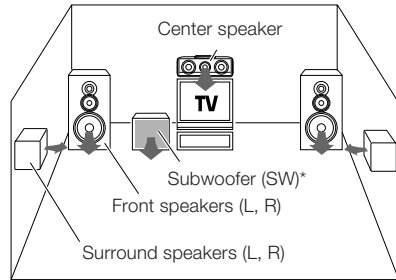

**DVD 6-channel mode
(except VR-505/KRF-V5550D)**

Using a DVD player or the like equipped with six (5.1) output channels and the receiver, you can enjoy multi-channel encoded DVD source material in all its splendor. Since the source signals are digital and each channel is input independently, the resulting sound quality, sense of spaciousness, and dynamic range are superb.



*LFE = Low Frequency Effects. This channel delivers separate non-directional bass signals to the subwoofer for more dynamic deep bass sound effects.

Surround play

The DTS compatible models can reproduce a CD, DVD, or LD carrying the DTS mark. DOLBY DIGITAL can be used when playing DVD or LD software bearing the  mark and DOLBY DIGITAL format digital broadcasts (etc.). DOLBY PRO LOGIC and DOLBY 3 STEREO can be used when playing video, DVD, or LD software bearing the  mark.

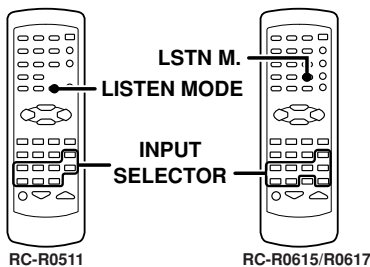
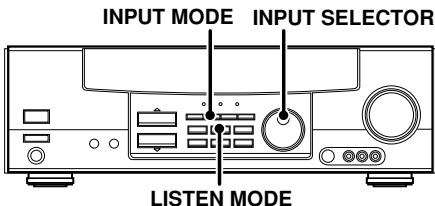

Preparations

- Turn ON related components.
- Complete "Preparing for surround sound" (speaker settings). → [19]
- Use the **INPUT SELECTOR** to select the component you wish to play back with surround sound.
- Use the **INPUT MODE** key to select the input mode (analog or digital) for the source you wish to play back. → [9]
- Noise will be produced when a DTS source is played by selecting the analog input.

1 Start playing the video software.

2 Press the LISTEN MODE (LSTN M.) key to select the listening mode.

The listening mode settings are stored separately for each input. If the input mode is set to digital auto ("AUTO SOUND" lights), the receiver selects the optimal listening mode automatically based on the type of input signal and the speaker settings.

Each press of the LISTEN MODE (LSTN M.) key switches the setting as listed below.
The listening mode settings are different depending on the type of input signal.

When the DOLBY DIGITAL signal is input:

(The DOLBY DIGITAL, PROLOGIC, or 3 STEREO indicator lights up.)

- 1 **DOLBY DIGITAL:** DOLBY DIGITAL surround
- 2 **PRO LOGIC:** PRO LOGIC surround (The PRO LOGIC indicator lights up.)
- 3 **3 STEREO:** 3-STEREO surround
- 4 **STEREO:** Normal stereo playback

When you select DOLBY DIGITAL

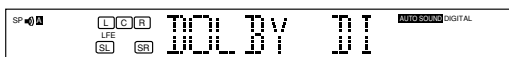

When the DTS signal is input:

(The DTS indicator lights up.)

- 1 **DTS:** DTS surround
- 2 **STEREO:** Normal stereo playback

When the analog signal or the digital signal (except for DOLBY DIGITAL or DTS signal) is input:

- 1 **PRO LOGIC:** PRO LOGIC surround (The PRO LOGIC indicator lights up.)
- 2 **3 STEREO:** 3-STEREO surround (The 3 STEREO indicator lights up.)
- 3 **ARENA:** DSP surround.
- 4 **JAZZ CLUB:** DSP surround.
- 5 **THEATER:** DSP surround.
- 6 **STADIUM:** DSP surround.
- 7 **DISCO:** DSP surround.
- 8 **STEREO:** Normal stereo playback. Sound is produced from the two front channels only.

- If a Dolby Digital signal having more channels than the maximum number of playback channels available using the receiver's current settings is input, the **DOWNMIX** indicator on the front panel lights up and downmixing is performed to match the number of available channels.

3 Adjust the volume.

Notes

- Depending on the type of the signal or speaker setting, some listening modes cannot be selected.
- When playback is started, the sound may be cut or interrupted before the input source is confirmed as Dolby Digital.
- To enjoy Dolby Digital surround (as well as all the other listening modes) from a single component, be sure to use a Dolby Digital compatible source component. Connect the Dolby Digital compatible source component's Dolby Digital format digital audio signal to one of the **DIGITAL INPUT** jacks on the back of the receiver. Connect the normal audio signal correctly to the respective component's **AUDIO** jacks. → [10] → [11] → [12] → [13]

DVD 6-channel playback (VR-506/517/KRF-V6050D/V5050D)

28

Using a DVD player or the like equipped with six (5.1) output channels and the receiver, you can enjoy surround sound playback. When you try to play a disc other than Dolby Digital such as DTS CD, no sound is produced or, noise may be heard. To avoid this situation, make sure that you connect the component to the receiver's DVD/6ch. INPUT jacks through a surround processor which can decode the surround signal you want to listen to. Connecting a DVD player which can decode the surround signal itself is also acceptable.

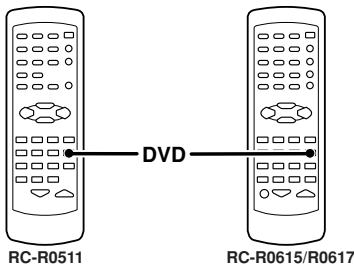
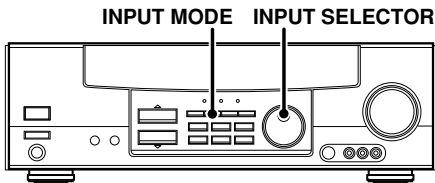

Preparations

- Connect your DVD player to the DVD/6ch jacks of the receiver.
- Turn on all other components that will be used.
- Complete "Preparing for surround sound".

→ [19]

1 Select "DVD/6ch" as the input source.

- If speaker system B is on when "DVD/6ch" is selected as the input source, it switches off and speaker system A turns on automatically.

2 Select "6ch INPT" by pressing the INPUT MODE key.

3 Start playback of the DVD software.

4 Adjust the volume.

- It is not possible to adjust the volume level or sound quality (SET UP, SOUND) of the channels separately when the receiver is in the DVD/6ch mode. Adjust the volume with the controls of the DVD player. For the powered subwoofer, you can adjust the volume of the subwoofer using the subwoofer's own volume control.

Convenient functions

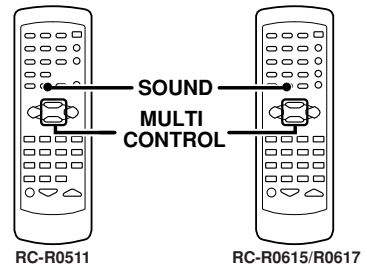
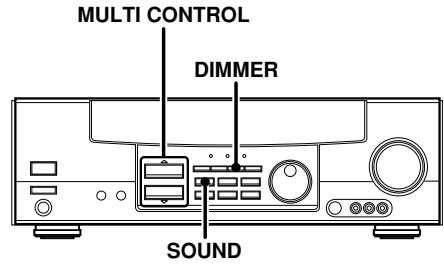

Adjusting the sound

You can make further adjustments to the sound while listening to playback in the surround mode.

- 1 Press the **SOUND** key until the desired item appears in the display.

Each time you press the button, the menu changes as follows:
Note that some items are not displayed in certain modes.

- ① **BASS** (low frequency range sound quality adjustment) → [21]
- ② **TREB** (high frequency range sound quality adjustment) → [21]
- ③ **C** (center speaker level adjustment)
- ④ **SR** (right surround speaker level adjustment)
- ⑤ **SL** (left surround speaker level adjustment)
- ⑥ **SW** (subwoofer level adjustment)
- ⑦ **INPUT** (input level adjustment) → [20]
- ⑧ **NIGHT** (midnight mode on/off)

- 2 Use the **MULTI CONTROL** keys to adjust the setting as desired.

- The adjustment item is displayed for approximately 8 seconds.

Midnight mode (Dolby Digital mode only)

When watching movies at night you might not be able to raise the volume as loud as normal. Midnight mode compresses the dynamic range of previously specified parts of the Dolby Digital sound track (like scenes with sudden increases in volume) to minimize the difference in volume between the specified and non-specified parts. This makes it easy to hear all of the sound track, even when listening at low volumes.

1 Press the SOUND key repeatedly until "NIGHT" appears on the display.

- This can be selected only if CD/DVD, DVD (VR-505/KRF-V5550D only) or VIDEO2 is selected as the source and the listen mode is set to "DOLBY DIGITAL."

2 Use the MULTI CONTROL keys to select the ON or OFF setting.



- The adjustment item is displayed for approximately 8 seconds.
- Some Dolby Digital software may not be compatible with the Midnight mode.

Display dimmer adjustment

The dimmer function lets you select the brightness of the receiver's display. You might find this useful if you darken your room to watch movies or listen to music.

Each time you press the DIMMER key, the display brightness changes among the three available settings. Select the brightness level you find most pleasing.

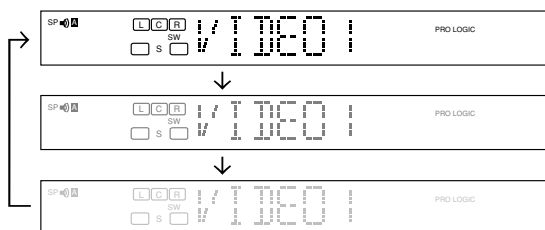

96kHz LPCM playback

The receiver is compatible with the 96kHz LPCM playback. To play a 96kHz DVD, set the listen mode to "STEREO".

- When "96kHz" appears in the display, press the LISTEN MODE key (the listen mode changes to the STEREO mode).

Basic remote control operations for other components

(For VR-506/517/KRF-V6050D/V5550D)

The remote control supplied with this receiver (for VR-506/517/KRF-V6050D/V5550D only) is also capable of controlling components from a variety of manufacturers once you register the appropriate setup codes into the remote control unit.

Low battery warning

Replace all four batteries with new ones when you notice a shortening of the distance from which the remote control will operate. The remote control is designed to retain setup codes in memory while you change batteries.

Registering setup codes for other components

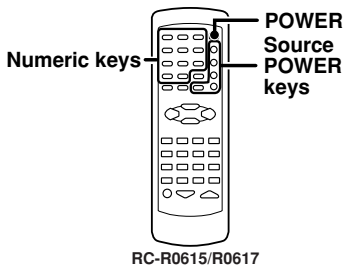

RC-R0615/R0617

1 Find the setup code of the component to be registered.

- Refer to the setup code lists to find the setup code for the component to be registered. → 31
- Example: To register a DVD made by KENWOOD, you would enter "805".

Input	Component	Maker	Code	Key
(DVD)	DVD player	KENWOOD	805, 808	DVD

2 Hold down the POWER key and press the numeric keys to enter the setup code.

- Example: Press "805" to register a DVD player made by KENWOOD.
- If you push an invalid key, the remote will exit the setup mode.

3 Press the source POWER (TV, VCR, DVD, CABLE, DSS)key for more than 2 seconds, and check to see that the component you want to control turns on.

If the component does not react, and there is more than one setup code, enter another setup code and try again.

- ▶/II, TUNING ◀▶, or MULTICONTROL key(s) can also be used instead of the POWER key.
- If the component is already on, pressing the source POWER keys will turn it off.

4 Repeat steps 2 to 3 to register additional components until all components have been registered.

Note

Although each setup code is designed to work with a number of different models, certain codes may not work with some models. (Also, certain codes may only operate some of the functions available on a given model.)

Operating other components

This operation lets you operate the registered components. KENWOOD audio components with system control turn on and off automatically with the receiver via the system control connections.

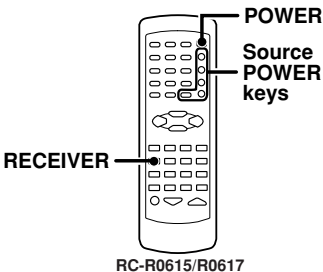

RC-R0615/R0617

1 Use the input selector keys to select the component you desire.

- Pressing the input selector keys also changes the input selector on the receiver.
- When you operate your registered TV, VCR, DVD player, Cable tuner, or DSS receiver, go to step 2.
- When you operate the CD player, Cassette deck, MD player, or Tuner with system control connection, go to step 2.

2 Press the source POWER key.

3 Press the operation keys you desire. → 34

- To return to the receiver operation mode, press the REVERSE key.
- The remote control mode returns to the receiver operation mode when you do not operate for more than 15 seconds.

Note

Be sure to point the remote control at the remote sensor on the receiver when you want to operate KENWOOD components connected by system control cords. Otherwise, point the remote control at the component you want to operate.

Setup code chart

TV Setup codes

Maker	Setup codes
SONY	101
GE/RCA	102
RCA	103, 104, 105, 106, 117
ZENITH	107, 108
MAGNAVOX	109
SHARP	110
PANASONIC	111, 112, 122
SAMSUNG	109
JVC	113
HITACHI	114, 115
PIONEER	116
PROSCAN	117
QUASAR	118
PHILIPS	109
SANYO	119
TOSHIBA	120
MITUBISHI	121
LOEWE	123, 124

CABLE Setup codes

Maker	Setup codes
JERROLD	201, 202
S.ATLANTA	203
ZENITH	204, 205
PIONEER	206, 207
TOCOM	208
G.I.	209
HAMLIN	210, 211
OAK	212, 213, 214
MACOM	215, 216, 217
GEMINI	218
PHILIPS	219, 220
PANASONIC	221, 222
SAMSUNG	223

VCR Setup codes

Maker	Setup codes
SONY	301, 302, 303, 304, 305, 306
GE/HITACHI	307
RCA/HITACHI	308
PANASONIC	309, 310
MAGNAVOX	311, 312, 313
TOSHIBA	314
MITSUBISHI	315, 316, 317, 318
SHARP	319, 320
G.E	321
ZENITH	322
GOLD STAR	323
JVC	324, 325, 326, 327
PHILIPS	313
HITACHI	328, 329
SANYO	330
TOSHIBA	331

DSS Setup codes

Maker	Setup codes
RCA	901
G.I.	902
ECHOSTAR	903
TOSHIBA	904
PANASONIC	905
HUGHES	906
SONY	907
HITACHI	908
PRIMESTAR	909

DVD Setup codes

Maker	Setup codes
JVC	801
SONY	802
PIONEER	803
PANASONIC	804
KENWOOD	805, 808
TOSHIBA	806
PHILIPS	807

DVD player operation keys (For VR-505/KRF-V5050D)

32

The remote control of this unit can control two groups of KENWOOD DVD players directly without using the remote control supplied with the DVD player.

Group-1: DV-4900, DV-4070B, DV-2070, DV-203, DVF-9010, DVF-K7010, DVF-5010, DVF-R9030, DVF-R7030, DVF-3530 and DV-402

Group-2: DV-4050, DV-303, DVF-R6030, DVF-K5020, DVF-5020, DVF-3020 and DVF-3030

Depending on your KENWOOD DVD model, you need to set up your receiver remote control as follows:

To set for Group-1 DVD players:

Press the numeric "1" key while pressing the "POWER" key (not the DVD Power key) on your remote control.

To set for Group-2 DVD players:

Press the numeric "2" key while pressing the "POWER" key (not the DVD Power key) on your remote control.

- If your DVD player is not listed in the list above, perform the set up for either Group-1 or Group-2. When the set up is successful, then your DVD player falls into that particular group.

How to operate the DVD player with the remote control

- Pressing the DVD Power key for more than 2 seconds turns the DVD player on or off.
- To carry out the functions of the DVD player, first press the DVD Power key, then press each key for each operation as explained in the DVD operation pages in the operating instructions. In this case, the DVD operation mode is retained for 15 seconds after pressing any of those DVD operation buttons.
(To turn the receiver operation mode within 15 seconds, press the RECEIVER key.)

DVD player operation keys

You can perform these basic operations using the keys described below when connected to KENWOOD DVD player.

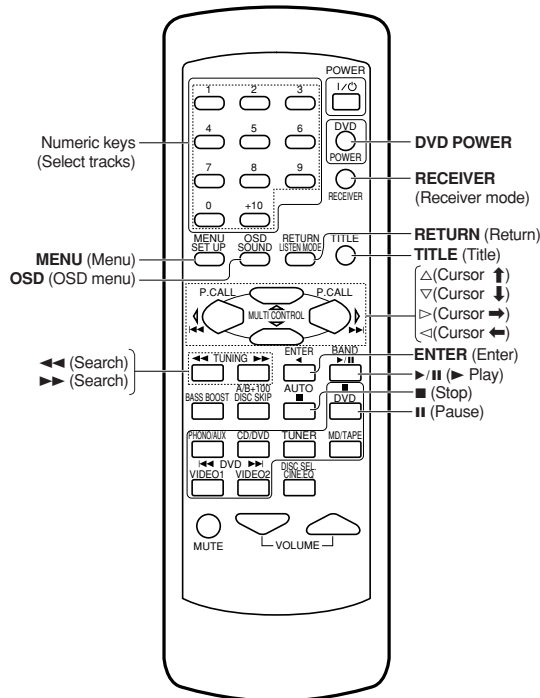

RC-R0511

CASSETTE deck, CD player & MD recorder operations

(For VR-505/KRF-V5050D)

You can perform these basic operations using the keys described below when connected to KENWOOD cassette deck, MD recorder or CD player equipped with system control operations.

- 15 -

Cassette deck operation keys

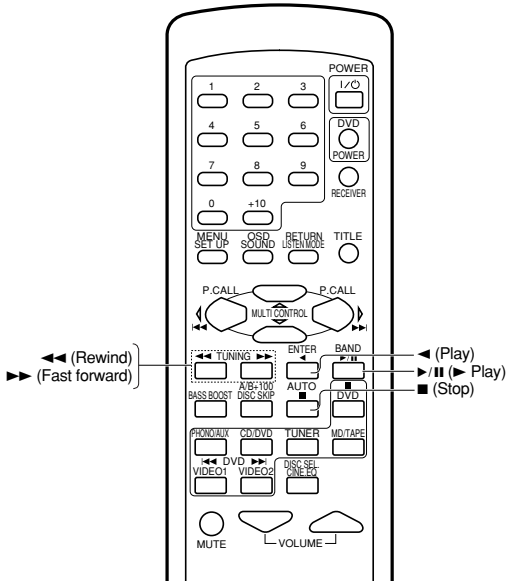

RC-R0511

CD player operation keys

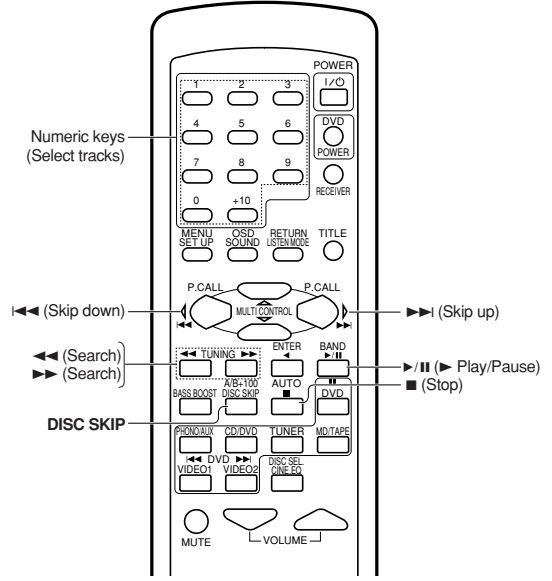

RC-R0511

MD recorder operation keys

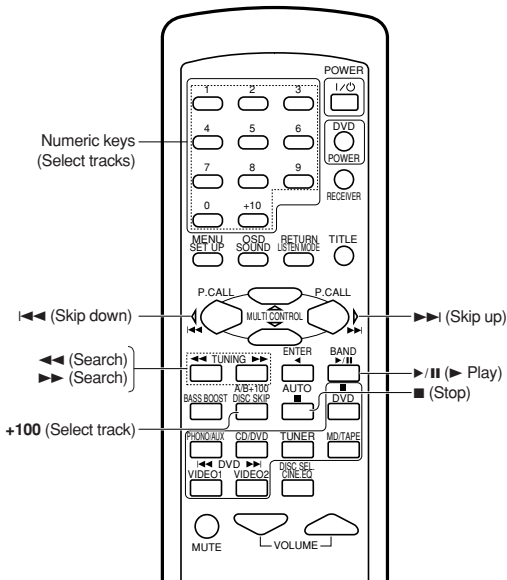

RC-R0511

Notes

1. Certain codes may only operate some of the function available on a given model.
2. The charts above show the typical functions available for each component. Some manufacturers use different key combinations to perform similar functions. For that reason, we have programmed extra functions on some of the unused number keys to help you control your equipment.

CASSETTE deck, CD player & MD recorder operations (For VR-506/517/KRF-V6050D/V5550D)

You can perform these basic operations using the keys described below when connected to KENWOOD cassette deck, MD recorder or CD player equipped with system control operations.

→ 15

Cassette deck operation keys

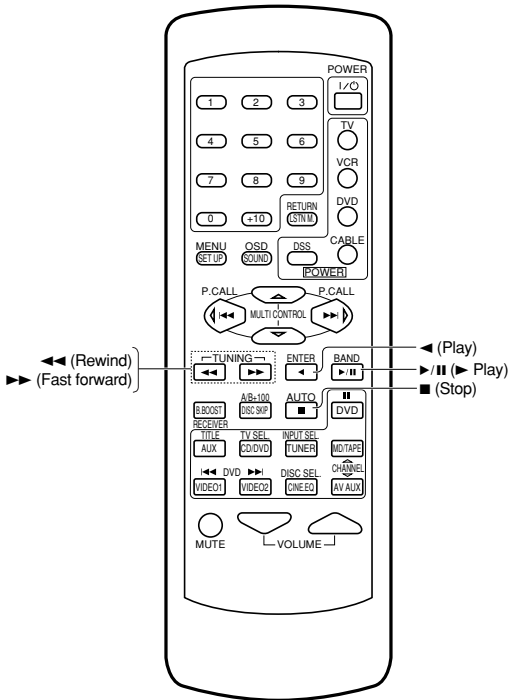

RC-R0617

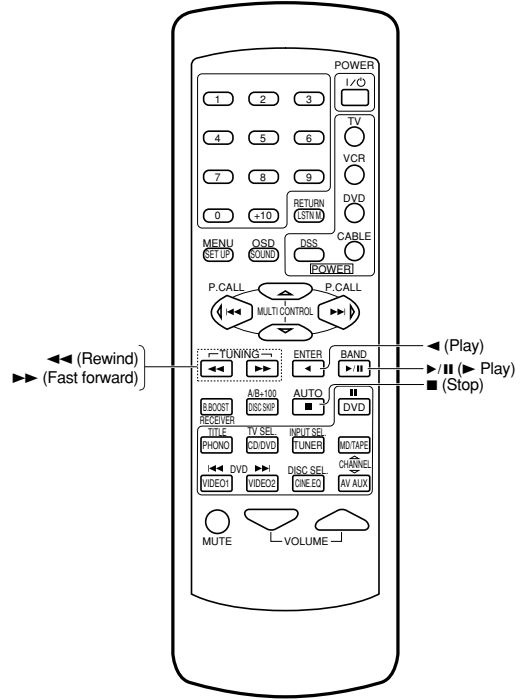

RC-R0615

CD player operation keys

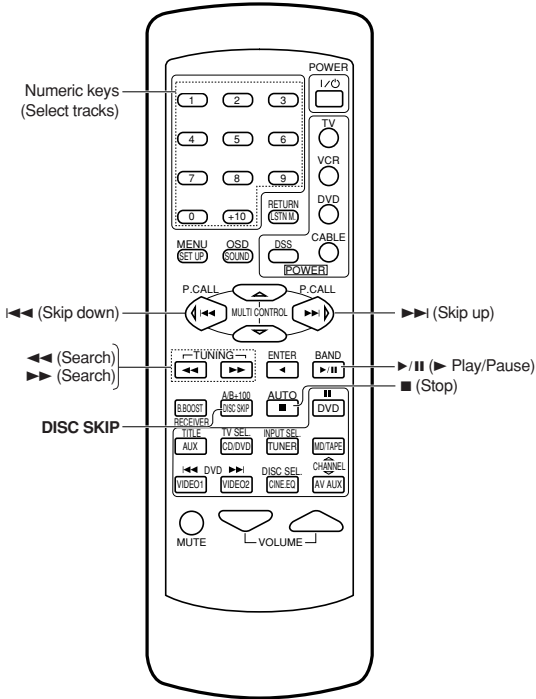

RC-R0617

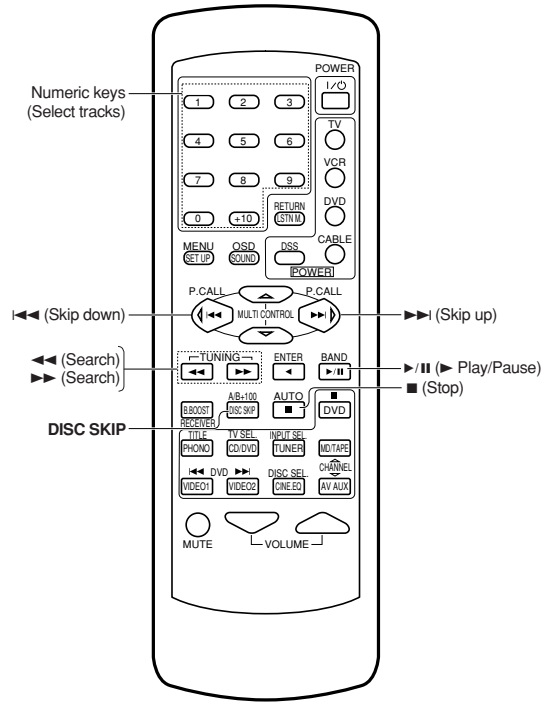

RC-R0615

MD recorder operation keys

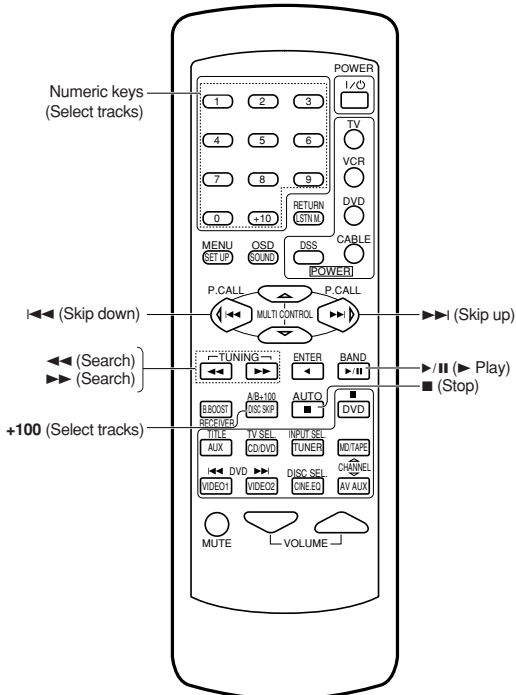

RC-R0617

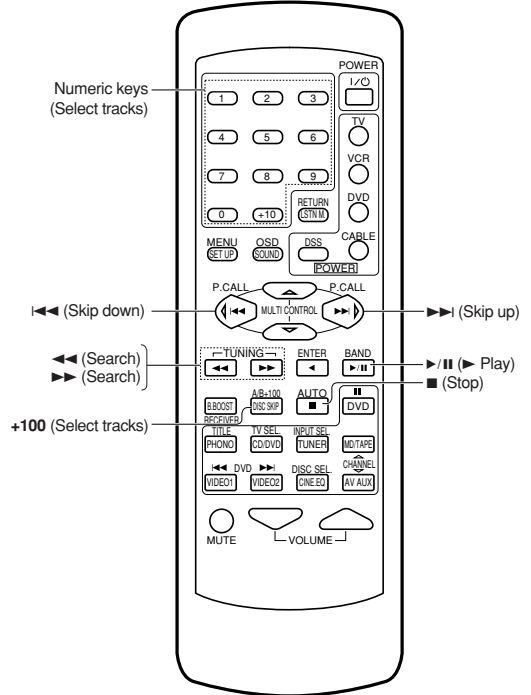

RC-R0615

Other components' operations (For VR-506/517/KRF-V6050D/V5550D)

36

Refer to the following for the type of remote control operations available for each component.

- 1 Select the input source.
- 2 Press the keys corresponding to the operations you desire. Refer to the following sections for details.

- When pressing keys in succession, press each key firmly and be sure to wait at least 1 second before pressing the next key.
- Numeric keys function the same as the numeric keys on the original remote.

These keys can be used to perform the basic operations of KENWOOD and other makers' components which the setup code for each component had been entered beforehand. - 31

TV operation keys

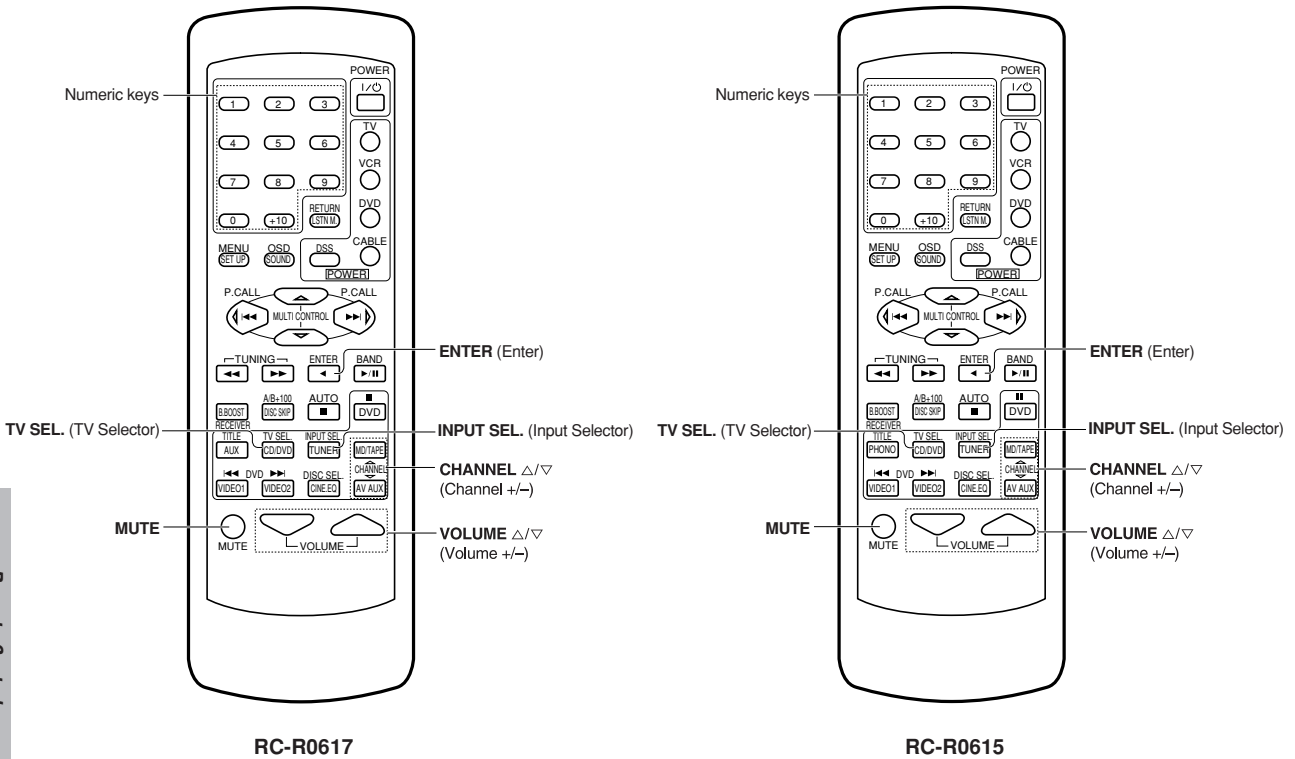

Remote Control

VCR operation keys

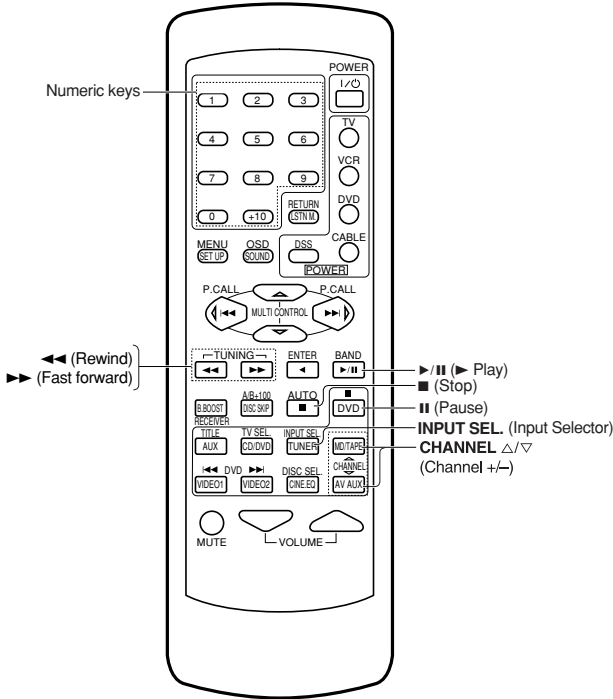

RC-R0617

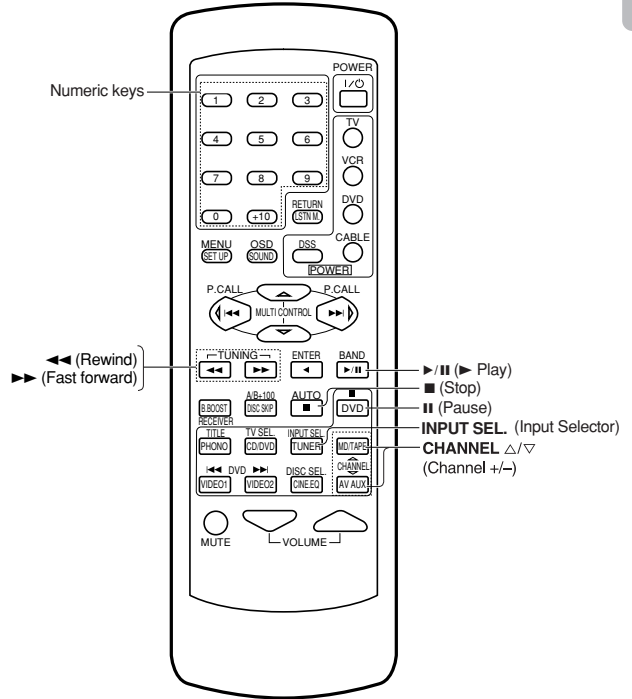

RC-R0615

DVD player operation keys

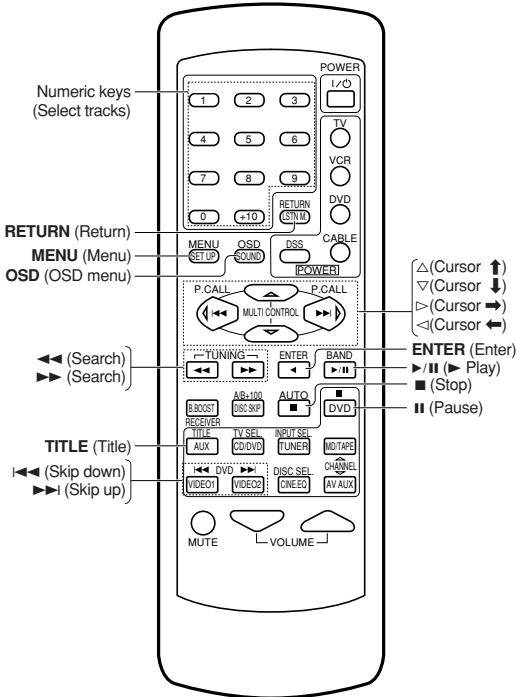

RC-R0617

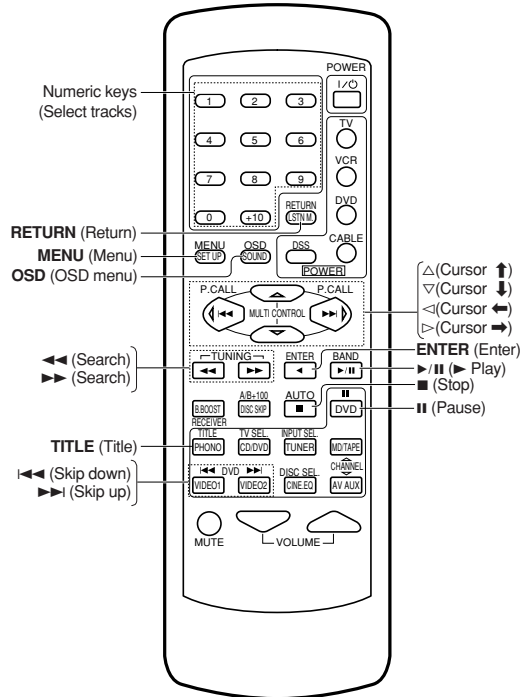

RC-R0615

DSS receiver operation keys

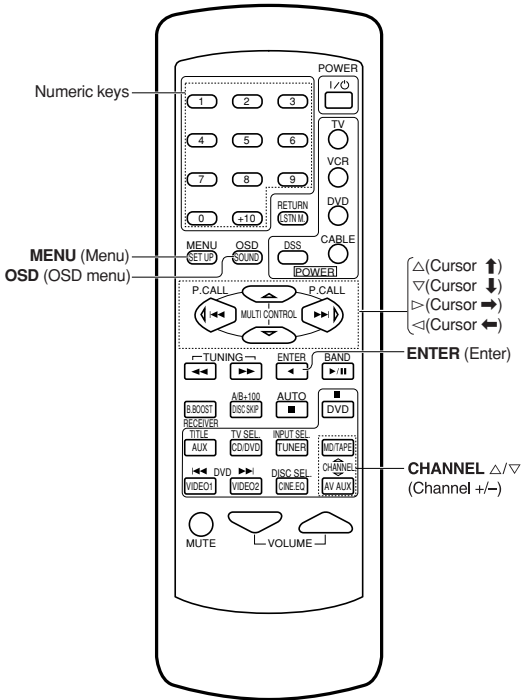

RC-R0617

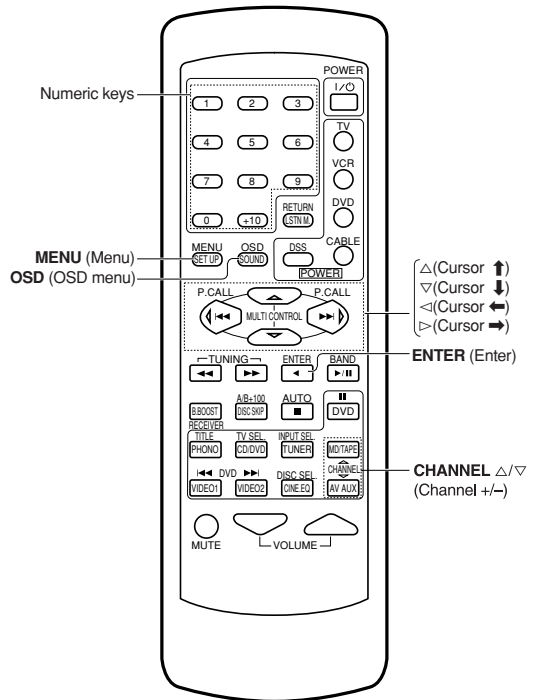

RC-R0615

Cable tuner operation keys

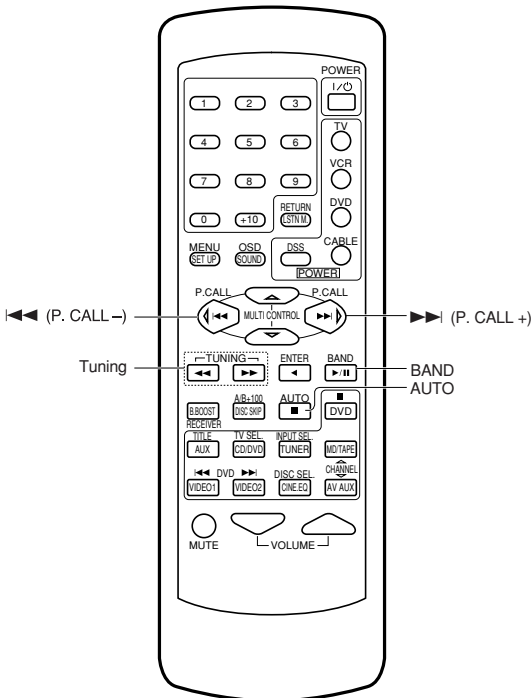

RC-R0617

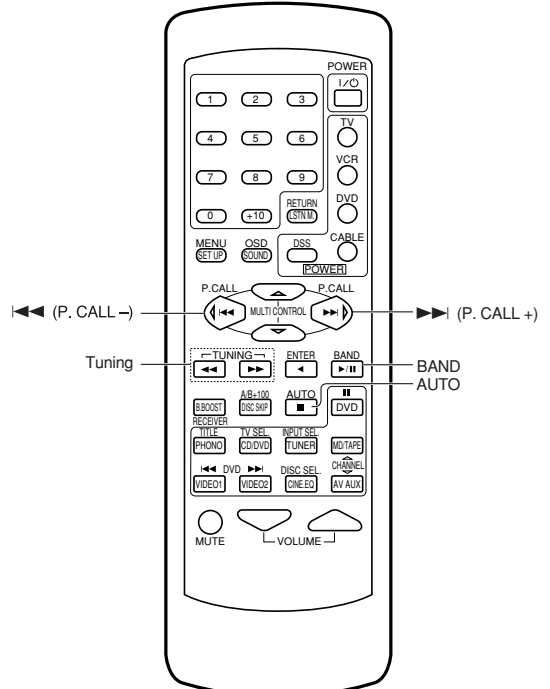

RC-R0615

Resetting the Microcomputer

The microcomputer may malfunction (unit cannot be operated, or shows an erroneous display) if the power cord is unplugged while the power is ON, or due to some other external factor. If this happens, execute the following procedure to reset the microcomputer and return the unit to its normal operating condition.

- Please note that resetting the microcomputer will clear the contents of the memory and returns the unit to the state it was in when it left the factory.

For U.S.A. and Canada

Unplug the power cord from the wall outlet, then plug it back in while holding down the POWER key.

For other countries

With the power cord plugged in, turn the POWER key OFF. Then, while holding down the ON/STANDBY key, press POWER.

Amplifier

Symptom	Cause	Remedy
No sound from the speakers.	<ul style="list-style-type: none"> • The speaker cords are disconnected. • VOLUME is set to the minimum position. • MUTE is ON. • The SPEAKERS switches are set to OFF. 	<ul style="list-style-type: none"> • Connect them properly referring to "Connecting the speakers" - [17] • Adjust the volume to a proper level. • Turn OFF the MUTE. - [22] • Set the SPEAKERS switch(es) to ON. - [20]
The standby indicator blinks and sound is not output.	<ul style="list-style-type: none"> • Speaker cords are short-circuited. 	<ul style="list-style-type: none"> • Turn the power off, eliminate the short-circuiting, then turn on the power again.
Sound is not output from one of the speakers.	<ul style="list-style-type: none"> • The speaker cord is disconnected. 	<ul style="list-style-type: none"> • Connect it properly referring to "Connecting the speakers". - [17]
Sound is not output from the surround speakers and / or the center speaker, or their sound is very small.	<ul style="list-style-type: none"> • The surround speaker cords and/or the center speaker cord is disconnected. • A surround mode has not been engaged. • The surround and/or center volume controls are set to the minimum level. 	<ul style="list-style-type: none"> • Connect it properly referring to "Connecting the speakers". - [17] • Select a surround mode. • Adjust the speaker levels using the test tone. - [19]
A humming noise is generated when the PHONO input selector is selected.	<ul style="list-style-type: none"> • The audio cord from the turntable is not connected to the PHONO jacks. • The turntable is not grounded. 	<ul style="list-style-type: none"> • Insert the audio cord plugs securely into the PHONO jacks. • Connect the grounding wire to the GND terminal on the rear panel.
When playing a Dolby Digital source signal using a DVD player, the sound is cut off soon after it starts.	<ul style="list-style-type: none"> • There are many possible causes for this problem, depending on the type of DVD player used. 	<ul style="list-style-type: none"> • Set the input mode to digital manual before starting playback of the Dolby Digital source. - [9]
No sound is produced during playback from a DVD player.	<ul style="list-style-type: none"> • The input mode is set to digital manual. 	<ul style="list-style-type: none"> • Press the INPUT MODE key to select to digital auto mode. - [9]
A video source cannot be recorded normally.	<ul style="list-style-type: none"> • The software is copy-guarded. 	<ul style="list-style-type: none"> • Copy-guarded video software cannot be recorded.

Tuner

Symptom	Cause	Remedy
Radio stations cannot be received.	<ul style="list-style-type: none"> • No antenna is connected. • The broadcast band is not set properly. • The frequency of the desired station is not tuned. 	<ul style="list-style-type: none"> • Connect an antenna. - [14] • Set the broadcast band properly. • Tune the frequency of the desired station. - [23]
Interference.	<ul style="list-style-type: none"> • Noise due to ignition noise from an automobile. • Noise due to interference from an electric appliance. • Noise due to a nearby TV set. 	<ul style="list-style-type: none"> • Install the outdoor antenna away from the road. • Turn off the power to the appliance. • Install the receiver farther away from the TV.
A station which was preset cannot be received by pressing the corresponding numeric key.	<ul style="list-style-type: none"> • The preset station belongs to a frequency that cannot be received. • The preset memory was cleared because the power cord had been unplugged for a long period of time. 	<ul style="list-style-type: none"> • Preset a station with a receivable frequency. • Preset the station again.

Remote control unit

40

Symptom	Cause	Remedy
Certain inputs cannot be selected using the remote control.	<ul style="list-style-type: none"> No setup codes registered at for the respective input(s). 	<ul style="list-style-type: none"> Register a setup code at the respective input(s). → 30
Remote control operation is not possible.	<ul style="list-style-type: none"> The remote control is set to a different operation mode. Batteries are exhausted. The remote control unit is too far away from the main system, controlling angle is too large, or there is an obstacle between the receiver and the remote. The audio cords and system control cords are not connected properly. No software is loaded in the source component. An attempt is made to play a tape which is being recorded in the cassette deck. The remote control has not been set to the operation mode for the component you wish to control. The microprocessor of the remote control malfunctions. 	<ul style="list-style-type: none"> Press the source select keys or source POWER keys to select the appropriate operation mode. Replace with new batteries. Operate the remote control unit within the controllable range. Connect properly referring to "Setting up the system". Place software in the source component you want to play. Wait until recording has completed. Press the source select keys or source POWER keys to activate the operation mode for the component you want to control before operation. → 29 Reset the microprocessor.

For U.S.A and Canada

AUDIO section (VR-506)

Rated power output during STEREO operation

100 watts per channel minimum RMS, both channels driven, at 8 Ω from 40Hz to 20 kHz with no more than 0.7% total harmonic distortion. (FTC)

Effective power output during SURROUND operation

FRONT (40-20kHz, 0.7% T.H.D. at 8 Ω one channel driven)	100 W + 100 W
CENTER (40-20kHz, 0.7% T.H.D. at 8 Ω one channel driven)	100 W
SURROUND (40-20kHz, 0.7% T.H.D. at 8 Ω one channel driven)	100 W + 100 W
Total harmonic distortion	0.050% (1 kHz, 50W, 8 Ω)
Frequency response	10 Hz ~ 60 kHz, +0 dB, -3.0 dB
CD	10 Hz ~ 60 kHz, +0 dB, -3.0 dB
Signal to noise ratio (IHF'66)	
PHONO (MM)	74 dB
CD	90 dB
Input sensitivity / impedance	
PHONO (MM)	2.5 mV / 27 kΩ
CD	200 mV / 47 kΩ
MONITOR IN (VIDEO2/MONITOR)	200 mV / 47 kΩ
DVD/6ch INPUT	200 mV / 47 kΩ
Output level / impedance	
TAPE REC	200 mV / 1 kΩ
MONITOR OUT (VIDEO2/MONITOR)	200 mV / 1 kΩ
PRE OUT (SUBWOOFER)	1.5 V / 2.2 kΩ
Tone control	
BASS	±10 dB (at 70 Hz)
TREBLE	±10 dB (at 10 kHz)

AUDIO section (VR-505/517)

Rated power output during STEREO operation

100 watts per channel minimum RMS, both channels driven, at 8 Ω from 40 Hz to 20 kHz with no more than 0.7% total harmonic distortion. (FTC)

Effective power output during SURROUND operation

FRONT (40-20kHz, 0.7% T.H.D. at 8 Ω one channel driven)	100 W + 100 W
CENTER (40-20kHz, 0.7% T.H.D. at 8 Ω one channel driven)	100 W
SURROUND (40-20kHz, 0.7% T.H.D. at 8 Ω one channel driven)	100 W + 100 W
Total harmonic distortion	0.050% (1 kHz, 50W, 8 Ω)
Frequency response	10 Hz ~ 60 kHz, +0 dB, -3.0 dB
CD	10 Hz ~ 60 kHz, +0 dB, -3.0 dB
Signal to noise ratio (IHF'66)	
CD	90 dB
Input sensitivity / impedance	
CD	200 mV / 47 kΩ
MONITOR IN (VIDEO2/MONITOR)	200 mV / 47 kΩ
PHONO (MM) (VR-517)	2.5 mV / 27 kΩ
DVD/6ch INPUT (VR-517)	200 mV / 47 kΩ
Output level / impedance	
TAPE REC	200 mV / 1 kΩ
MONITOR OUT (VIDEO2/MONITOR)	200 mV / 1 kΩ
PRE OUT (SUBWOOFER) (VR-505)	1.5 V / 2.2 kΩ
Tone control	
BASS	±10 dB (at 70 Hz)
TREBLE	±10 dB (at 10 kHz)

DIGITAL AUDIO section

Sampling frequency	32 kHz, 44.1 kHz, 48 kHz, 96kHz
Input level / impedance / wave length	
Optical	(-15 dBm ~ -21 dBm), 660 nm ±30nm
Coaxial	0.5 Vp-p / 75 Ω

VIDEO section

VIDEO inputs / outputs	
VIDEO (composite)	1 Vp-p / 75 Ω
S VIDEO inputs / outputs (VR-506/517)	
S VIDEO (luminance signal)	1 Vp-p / 75 Ω
S VIDEO (chrominance signal)	0.286 Vp-p / 75 Ω

FM tuner section

Tuning frequency range	87.5 MHz ~ 108 MHz
Usable sensitivity (MONO)	1.3 μV (75 Ω) / 13.2 dBf (75 kHz DEV., SINAD 30 dB)
50dB quieting sensitivity	
STEREO	28 μV (75 Ω) / 40.2 dBf
Total harmonic distortion (1 kHz)	
MONO	0.5% (71.2 dBf input)
STEREO	0.7% (71.2 dBf input)
Signal to noise ratio (1 kHz, 75 kHz DEV.)	
MONO	75 dB (71.2 dBf input)
STEREO	68 dB (71.2 dBf input)
Stereo separation (1 kHz)	40 dB
Selectivity (±400 kHz)	70 dB
Frequency response	(30 Hz ~ 15kHz), +0.5 dB, -3.0 dB

AM tuner section

Tuning frequency range	
10 kHz step	530 kHz ~ 1,700 kHz
Usable sensitivity (30% mod., S/N 20 dB)	16 μV / (600 μV/m)
Signal to noise ratio (30% mod. 1 mV input)	50 dB

GENERAL

Power consumption	2.6 A
AC outlet	
SWITCHED	(total 150 W, 1.25 A max.)
Dimensions	W : 440 mm (17-5/16")
	H : 143 mm (5-11/16")
	D : 400 mm (15-3/8")
Weight (Net)	
VR-506/517	8.8 kg (18.92 lb)
VR-505	8.7 kg (18.89 lb)

Notes

1. KENWOOD follows a policy of continuous advancements in development. For this reason specifications may be changed without notice.
2. The full performance may not be exhibited in an extremely cold location (under a water-freezing temperature).

For other countries

42

AUDIO section (KRF-V6050D)

Effective power output during STEREO operation
1kHz,10% T.H.D.,at 8 Ω 140 W + 140 W
Rated power output during STEREO operation

100 watts per channel minimum RMS, both channels driven, at 8 Ω from 40 Hz to 20 kHz with no more than 0.7% total harmonic distortion.(FTC)

Effective power output during SURROUND operation
FRONT (1kHz, 10% T.H.D. at 8 Ω one channel driven) 140 W + 140 W
CENTER (1kHz, 10% T.H.D. at 8 Ω one channel driven) 140 W
SURROUND (1kHz, 10% T.H.D. at 8 Ω one channel driven) 140 W + 140 W
Total harmonic distortion 0.050% (1 kHz, 50W, 8 Ω)
Frequency response
CD 10 Hz ~ 60 kHz, +0 dB, -3.0 dB
Signal to noise ratio (IHF'66)
PHONO (MM) 74 dB
CD 90 dB
Input sensitivity / impedance
PHONO (MM) 2.5 mV / 27 kΩ
CD 200 mV / 47 kΩ
VIDEO2/MONITOR 200 mV / 47 kΩ
DVD/6ch INPUT 200 mV / 47 kΩ
Output level / impedance
TAPE REC 200 mV / 1 kΩ
VIDEO2/MONITOR 200 mV / 1 kΩ
PRE OUT (SUBWOOFER) 1.5 V / 2.2 kΩ
Tone control
BASS ±10 dB (at 70 Hz)
TREBLE ±10 dB (at 10 kHz)

AUDIO section (KRF-V5050D)

Effective power output during STEREO operation
(1 kHz, 10%, 8Ω) 140 W + 140 W
Rated power output during STEREO operation

100 watts channel minimum RMS, both channels driven, at 8 Ω from 40 Hz to 20 kHz with no more than 0.7% total harmonic distortion. (FTC)

Effective power output during SURROUND operation
FRONT (1kHz, 10% T.H.D. at 8 Ω one channel driven) 140 W + 140 W
CENTER (1kHz, 10% T.H.D. at 8 Ω one channel driven) 140 W
SURROUND (1kHz, 10% T.H.D. at 8 Ω one channel driven) 140 W + 140 W
Total harmonic distortion 0.050% (1 kHz, 50W, 8 Ω)
Frequency response
CD 10 Hz ~ 60 kHz, +0 dB, -3.0 dB
Signal to noise ratio (IHF'66)
PHONO (MM) 74 dB
CD, TUNER, AUX, TAPE 90 dB
Input sensitivity / impedance
PHONO (MM) 2.5 mV / 27 kΩ
CD 200 mV / 47 kΩ
MONITOR IN (VIDEO2/MONITOR) 200 mV / 47 kΩ
DVD/6ch INPUT 200 mV / 10 kΩ
Output level / impedance
TAPE REC 200 mV / 1 kΩ
MONITOR OUT (VIDEO2/MONITOR) 200 mV / 1 kΩ
PRE OUT (SUBWOOFER) 1.5 V / 2.2 kΩ
Tone control
BASS ±10 dB (at 70 Hz)
TREBLE ±10 dB (at 10 kHz)

AUDIO section (KRF-V5550D)

Effective power output during SURROUND operation
(1kHz, 10%, 8Ω) 110 W + 110 W
Rated power output during STEREO operation

80 watts per channel minimum RMS, both channels driven, at 8 Ω from 40 Hz to 20 kHz with no more than 0.7% total harmonic distortion. (FTC)

Effective power output during SURROUND operation
FRONT (1kHz, 10% T.H.D. at 8 Ω one channel driven) 130 W + 130 W
CENTER (1kHz, 10% T.H.D. at 8 Ω one channel driven) 130 W
SURROUND (1kHz, 10% T.H.D. at 8 Ω one channel driven) 130 W + 130 W
Total harmonic distortion 0.050% (1 kHz, 40W, 8 Ω)
Frequency response
CD 10 Hz ~ 60 kHz, +0 dB, -3.0 dB
Signal to noise ratio (IHF'66)
CD, TUNER, AUX, TAPE 90 dB
Input sensitivity / impedance
CD 200 mV / 47 kΩ
MONITOR IN (VIDEO2/MONITOR) 200 mV / 47 kΩ
Output level / impedance
TAPE REC 200 mV / 1 kΩ
MONITOR OUT (VIDEO2/MONITOR) 200 mV / 1 kΩ
Tone control
BASS ±10 dB (at 70 Hz)
TREBLE ±10 dB (at 10 kHz)

DIGITAL AUDIO section

Sampling frequency 32 kHz, 44.1 kHz, 48 kHz, 96kHz
Input level / impedance / wave length
Optical (-15 dBm ~ -21 dBm), 660 nm ±30nm
Coaxial 0.5 Vp-p / 75 Ω

VIDEO section

VIDEO inputs / outputs
VIDEO (composite) 1 Vp-p / 75 Ω
S VIDEO inputs / outputs (KRF-V6050D)
S VIDEO (luminance signal) 1 Vp-p / 75 Ω
S VIDEO (chrominance signal) 0.286 Vp-p / 75 Ω

FM tuner section

Tuning frequency range 87.5 MHz ~ 108 MHz
Usable sensitivity (MONO)
..... 1.6 μV (75 Ω)/ 15.2 dBf (75 kHz DEV., SINAD 30 dB)
50dB quieting sensitivity
STEREO 28 μV (75 Ω)/ 40.2 dBf
Total harmonic distortion (1 kHz)
MONO 0.5% (71.2 dBf input)
STEREO 0.7% (71.2 dBf input)
Signal to noise ratio (1 kHz, 75 kHz DEV.)
MONO 75 dB (71.2 dBf input)
STEREO 68 dB (71.2 dBf input)
Stereo separation (1 kHz) 40 dB
Selectivity (±400 kHz) 50 dB
Frequency response (30 Hz ~ 15kHz), +0.5 dB, -3.0 dB

AM tuner section

Tuning frequency range
9 kHz step 531 kHz ~ 1,602 kHz
10 kHz step 530 kHz ~ 1,610 kHz
Usable sensitivity 16 μV / (600 μV/m)
Signal to noise ratio (30% mod. 1 mV input) 50 dB

Notes

1. KENWOOD follows a policy of continuous advancements in development. For this reason specifications may be changed without notice.
2. The full performance may not be exhibited in an extremely cold location (under a water-freezing temperature).

GENERAL

Power consumption

KRF-V6050D/V5050D 270 W
KRF-V5550D 200 W

AC outlet

SWITCHED (total 90 W max.)

Dimensions W : 440 mm
H : 143 mm
D : 400 mm

Weight (Net)

(KRF-V6050D/V5050D) 9.3 kg
(KRF-V5550D) 8.4 kg

KENWOOD

For your records

Record the serial number, found on the back of the unit, in the spaces designated on the warranty card, and in the space provided below. Refer to the model and serial numbers whenever you call upon your dealer for information or service on this product.

Model _____ Serial Number _____

Free Manuals Download Website

<http://myh66.com>

<http://usermanuals.us>

<http://www.somanuals.com>

<http://www.4manuals.cc>

<http://www.manual-lib.com>

<http://www.404manual.com>

<http://www.luxmanual.com>

<http://aubethermostatmanual.com>

Golf course search by state

<http://golfingnear.com>

Email search by domain

<http://emailbydomain.com>

Auto manuals search

<http://auto.somanuals.com>

TV manuals search

<http://tv.somanuals.com>