

Edition 1

This publication could contain technical inaccuracies or typographical errors. Changes are made periodically to the information herein, these changes will be made in later editions. IBM may make improvements and/or changes in the product(s) and/or programs(s) at any time.

It is possible that this publication may contain reference to, or information about, IBM products (machines and programs), programming, or services that are not announced in your country.

Requests for copies of this publication and for technical information about IBM products should be made to your IBM Authorized Dealer or IBM Retailer.

No part of this publication may be reproduced or distributed in any form or by any means without prior permission in writing from the International Business Machines Corporation.

References in this publication to IBM products, programs, or services do not imply that IBM intends to make these available in all countries in which IBM operates. Any reference to an IBM product, program or service is not intended to state or imply that only IBM's product, program, or service may be used. Any functionally equivalent product, program, or service that does not infringe any of IBM's intellectual property rights or other legally protectable rights may be used instead of the IBM product, program, or service. Evaluation and verification of operation in conjunction with other products, programs, or services, except those expressly designated by IBM, are the user's responsibility.

IBM may have patents or pending patent applications covering subject matter in this document. The furnishing of this document does not give you any license to these patents

Trademarks

The following terms, used in this publication, are trademarks or service marks of the IBM Corporation in the United States or other countries:

ENERGY STAR is a U.S. registered mark.

© Copyright International Business Machines Corporation 1999
All rights reserved.

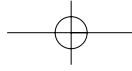

Packing List

The product package should include the following items:

1. Monitor
2. Owner's Manual
3. Power Cord
4. Swivel Base
5. Diskette

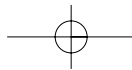
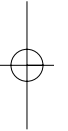
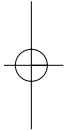

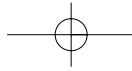

Table of Contents

Precautions
 Workplace preparationA1
 Working PracticesA2

Tilt/Swivel Base
 InstallationA4

Installation
 ConnectionsA5

Location and Function of Controls
 Front ViewA6
 Rear ViewA6

Image Control PanelA7

Power Management System, MPR II and DDC
 Power Management SystemA9
 Low Radiation Compliance (MPR II)A9
 DDC (Display Data Channel)A9

General OperationA10

Video Memory Modes
 Factory Preset Timing Signal ChartA11

TroubleshootingA12

Further helpA13

ServiceA14

SpecificationsA15

CompliancesA17

Warranty See back of manual

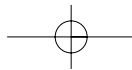

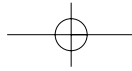

Precautions



To avoid shock hazard:

- Do not remove the covers.
- Do not operate this product unless the stand is attached.
- Do not connect or disconnect this product during an electrical storm.
- The power cord plug must be connected to a properly wired and grounded power outlet.
- Any equipment to which this product will be attached must also be connected to properly wired and grounded power outlets.
- To isolate the monitor from the electrical supply, you must remove the plug from the power outlet. The power outlet should be easily accessible.

Handling:

- Your color monitor is heavy, so handle it with care.

Workplace preparation

Positioning the Monitor

Choose a suitable place to position the monitor where it is not near fluorescent desk lighting or any equipment that produces magnetic fields that could cause interference. Ensure that the furniture or equipment can support the weight of the monitor. Allow at least 2 inches (50mm) ventilation space around the monitor.

Height

The monitor should be positioned so that the top of the screen is slightly below your eye level when you sit at your workstation.

Orientation

Choose a position that gives the least reflection from lights and windows, usually at a right angle to any windows. The monitor should be positioned directly in front of you so that you do not have to twist your body. Tilt the monitor to a comfortable viewing angle.

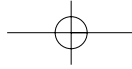

Precautions**Working Practices****Rest**

Take regular breaks. Vary your posture, and stand up and stretch occasionally as prolonged use of computer workstations can be tiring.

Back

You should sit back in the chair and use the back rest.

Hands

Use a light touch on the keyboard, keeping your hands and fingers relaxed. Allow a space in front of the keyboard to rest your wrists when not typing. Consider using a wristpad.

Eyesight

Working with monitors, in common with any prolonged close work, can be visually demanding. Look away from the screen periodically and have your eyesight checked regularly.

Screen settings

Set the screen brightness and contrast to a comfortable level. You may have to adjust this as the lighting changes during the day. Many application programs let you select color combinations which can help you to view in comfort.

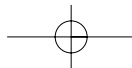

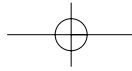

Precautions

Power Source:

1. Make sure the power cord is the correct type that required in your area.
2. This monitor has a universal power supply that allows operation in either 100/120V AC or 220/240V AC voltage area (No user adjustment is required.)
3. Connect the power cord into your monitor's power input socket, and then plug the other end into a 3-pin AC power outlet. The power cord may be connected to either a wall power outlet or the power outlet socket on your PC, depending on the type of power cord supplied with your monitor.

Power cord:

For safe operation, use the power cord supplied with the unit.

Notes

- Do not install the monitor in a location near heat sources such as radiators or air ducts , or in a place subject to direct sunlight , or excessive dust or mechanical vibration or shock.
- Save the original shipping carton and packing materials, as they will come in handy if you ever have to ship your monitor.
- To keep the monitor looking new, periodically clean it with a soft cloth. Stubborn stains may be removed with a cloth lightly dampened with a mild detergent solution. Never use strong solvents such as thinner, benzene, or abrasive cleaners, since these will damage the cabinet. As a safety precaution, always unplug the monitor before cleaning it.

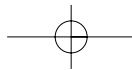

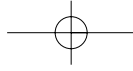

Tilt/Swivel Base

- Turn Off the equipment and all attached options.
- Carefully set the monitor face-down with the underside facing you.

Installation

1. Align the hooks on the tilt/swivel stand with the matching slots in the base of the monitor.
2. Insert the hooks into slots.
3. Slide the tilt/swivel stand toward the front of the monitor until the latches click into the locked position.

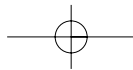
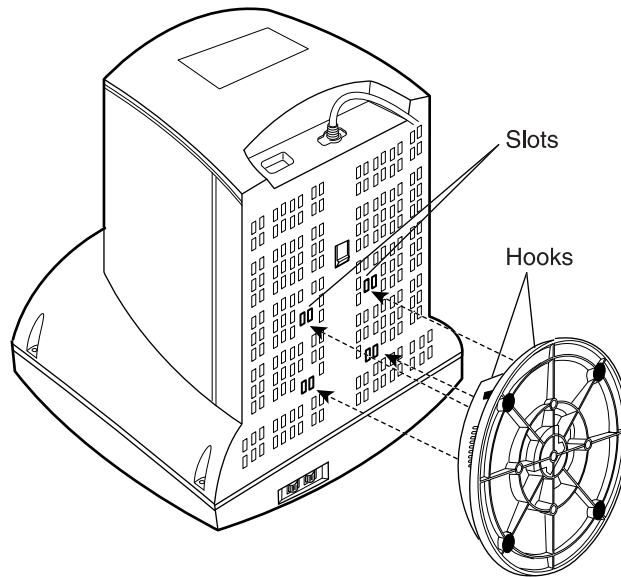

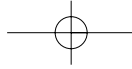

Installation

The supply voltage is marked on the ID label located on the rear panel of the monitor. If your local voltage is different, do not use the monitor and contact your supplier before using the display.

Connections

To connect your monitor after the video adapter is properly installed:

1. Turn OFF the power to your computer and all its attached options.
2. Position the monitor and the computer so that you can easily get to the back panel of each.
3. Connect the signal cable with D-sub connector to the graphics board on your PC as described in your PC Owner's Manual.
4. Tighten the screws on the video cable connectors to keep them from coming loose and to prevent radio and TV interference.
5. Connect the power cord to the AC receptacle on the back of the monitor. Plug the other end of the power cord into a properly grounded electrical outlet.
6. The socket-outlet should be installed near the equipment and should be easily accessible.

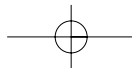

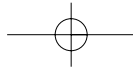

Location and Function of Controls

Front View

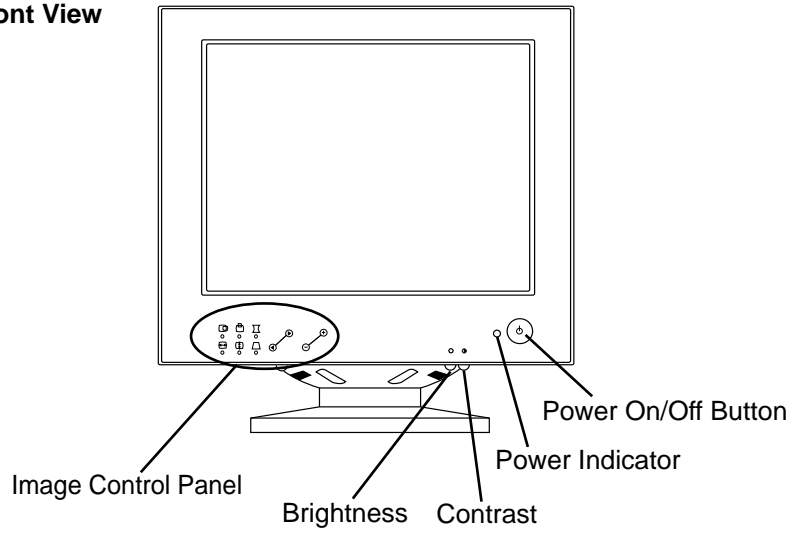

Rear View

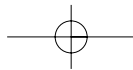
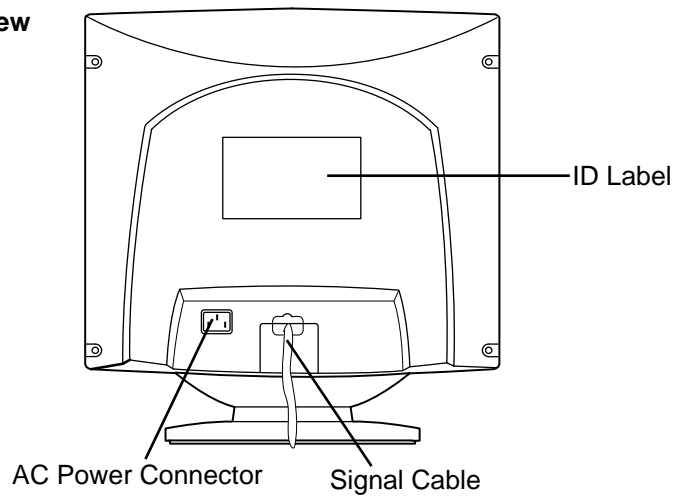

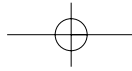

Location and Function of Controls



Power On/Off Button

This Button is used to turn the power On or Off.

Power Indicator

The power indicator lights when the power is On, and indicates the operating status of the display.



Contrast

Adjust the display to the contrast desired. Move the thumbwheel located beneath this indicator to increase or decrease the display contrast.



Brightness

Used to adjust the brightness of the screen. Move the thumbwheel located beneath this indicator to increase or decrease the display brightness.

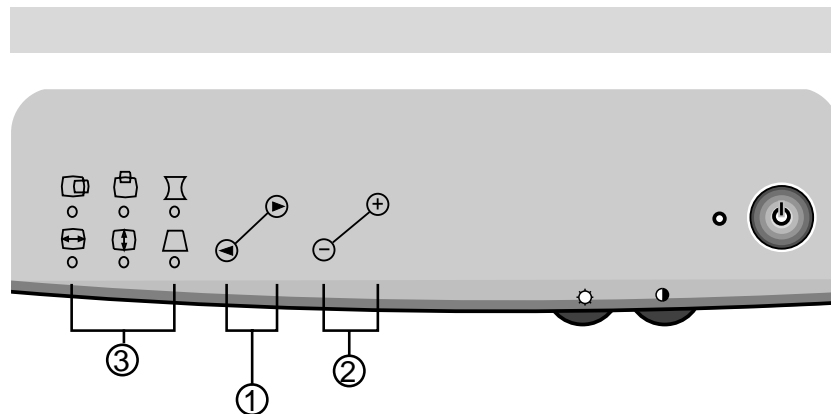

① Image Selection and Adjustment buttons

Use either the ◀ or ▶ button to select the icons which you wish to adjust and display.







② -/+ buttons

Used to set digital values for each of the select on screen control item by pressing + button for increment or - button for decrement.

Image Control Panel

③ Image Control Icons

Listed below are the icons, icon names, and icon descriptions of the items.

icon	Description
 Horizontal Position	To move picture image left and right. <ul style="list-style-type: none"> - Moves the screen image left. + Moves the screen image right.
 Horizontal Size	To adjust image width. <ul style="list-style-type: none"> - Decreases the size of the screen image. + Increases the size of the screen image.
 Vertical Position	To move image up and down. <ul style="list-style-type: none"> - Moves the screen image down. + Moves the screen image up.
 Vertical Size	To adjust image height. <ul style="list-style-type: none"> - Decreases the size of the screen image. + Increases the size of the screen image.
 Side Pincushion	To correct the bowing in and out of the image. <ul style="list-style-type: none"> - Curves the image's edges inwards. + Curves the image's edges outwards.
 Trapezoid	To correct geometric distortion. <ul style="list-style-type: none"> - Makes the screen image narrower at the top. + Moves the screen image wider at the top.

* Recall Function

When the user wants to recall one of the 5 factory fixed image modes, push the - and + buttons simultaneously. To recall the next image mode, press both the - and + buttons again.

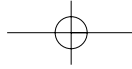

Power Management System

When used in conjunction with a PC having power saving circuitry, or a PC running screen blanking software this monitor automatically reduces its power consumption when the computer is not in use. The monitor has power-saving states, indicated by the light-emitting diode (LED) on the front panel. These power-saving states exceed the Environmental Protection Agency (EPA) Energy Star requirements using the methodology for Display Power Management Signals (DPMS). Developed by the Video Electronics Standards Association (VESA).

Low Radiation Compliance (MPR II)

This monitor meets one of the strictest guidelines available today for low radiation emissions, offering the user extra shielding and an anti-static screen coating. These guidelines, set forth by a government agency in Sweden, limits the amount of emission allowed in the Extremely Low Frequency (ELF) and Very Low Frequency (VLF) electromagnetic range.

DDC (Display Data Channel)

DDC is a communication channel over which the monitor automatically informs the host system (PC) about its capabilities. This monitor has DDC function; DDC2B carry out uni-directional communication between PC and monitor. Under these situations, the PC sends display data to the monitor but not commands to control the monitor servings.

- NOTE :**
- PC must support DDC functions to do this.
 - Some older computer systems are not compatible with the DDC standard. If your monitor is displaying a monochrome image or the wrong resolution, need to change with a DDC compatible VGA card.

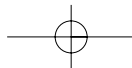

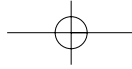

General Operation

After following the installation instructions and getting familiar with the controls, you are ready to operate the monitor.

1. Turn on the monitor, PC and other peripherals you plan to use.
2. After the PC has booted (powered up and finished self-testing), enter a software application that uses the full screen display.
3. While looking at the image on the screen, adjust the controls for the image size, centering, brightness and contrast levels you prefer.
4. This monitor is an auto scanning monitor, capable of synchronizing with a variety of video standards automatically. The Scanning Mode Table below indicates the resolution, as well as the horizontal and vertical refresh rates, of some of the modes that this monitor can match to the output of your PC's graphics card. Other resolutions and standards can also be synchronized and displays on this monitor as long as they are within the horizontal and vertical frequency range of this monitor. See the specifications for this information.

Video Memory Modes

Factory Preset Timing Signal Chart

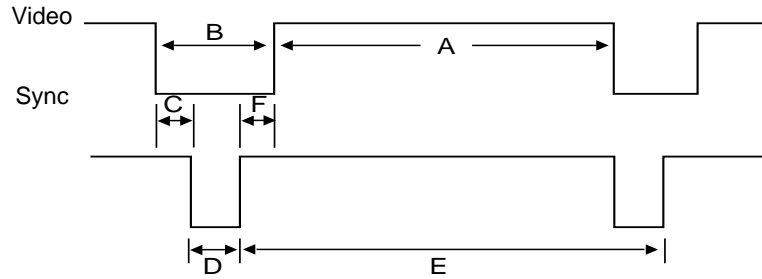

		Mode1	Mode2	Mode3	Mode4	Mode5	
H O R I Z O N T A L	Polarity	-	-	-	+	-	
	Frequency	kHz 31.47	37.5	43.3	46.875	48.36	
	Total Period	uS 31.78	26.667	23.111	21.333	20.677	E
	Data Period	uS 25.422	20.317	17.778	16.162	15.754	A
	Blanking	uS 6.356	6.349	5.333	5.172	4.923	B
	Front Porch	uS 0.636	0.508	1.556	0.323	0.369	C
	Pulse Width	uS 3.813	2.032	1.556	1.616	2.092	D
	Back Porch	uS 1.907	3.810	2.222	3.232	2.462	F
V E R T I C A L	Polarity	+	-	-	+	-	
	Frequency	Hz 59.94	75.0	85.0	75.0	60.0	
	Total Period	mS 16.683	13.333	11.764	13.333	16.666	E
	Data Period	mS 15.253	12.800	11.093	12.80	15.880	A
	Blanking	mS 1.430	0.533	0.670	0.533	0.786	B
	Front Porch	mS 0.318	0.027	0.023	0.021	0.062	C
	Pulse Width	mS 0.064	0.080	0.069	0.064	0.124	D
Back Porch	mS 1.049	0.427	0.578	0.448	0.600	F	
Resolution		640 x 480	640 x 480	640 x 480	800 x 600	1024 x 768	
Recall		YES	YES	YES	YES	YES	

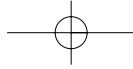

Troubleshooting

Symptom: The power LED is amber.

Possible causes:

- Display power management mode.
- There is no sync signal.
- The signal cable is not fastened securely.
- Check the computer power and graphics adapters configuration.
- The frequency of the sync input is outside the operating range of the monitor.

HORZ: 30kHz-49kHz

VERT: 50Hz-90Hz

Symptom: The image on the SCREEN is not centered, or too small or not a rectangle shape.

Possible Causes: Image adjustment not been done yet in the current operating mode. Use the SELECT and +/- buttons to set the image to your liking.

Symptom: The monitor doesn't enter the power saving off mode (Amber led).

Possible Causes: Computer video signal is not VESA DPMS standard. Enter the PC or the video controller card is not using the VESA DPMS power management function.

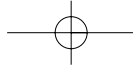

Further help

If you are unable to correct the problem yourself, you may seek further help as follows:

Call IBM HELPCENTER.
In the US call 1-800-772-2227
In Canada call 1-800-565-3344

In other countries, contact your dealer, retailer, or other IBM authorized servicer.

Before calling, please have available as much of the following information as possible:

1. Type, model and serial number from the label on the back of your monitor.
2. Purchase receipt.
3. Description of problem.
4. Computer type and model.
5. System configuration(hardware fitted etc.).
6. System BIOS version number.
7. Operating System and version number.
8. Display driver version number.

If possible, stay by your computer system. Your technical support representative might want to go through the problem with you during the call.

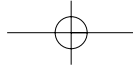

Service

1. Unplug the monitor from the wall outlet and refer servicing to alified service personnel when :
 - The power cord or plug is damaged or frayed.
 - Liquid has been spilled into the monitor.
 - The monitor has been exposed to rain or water.
 - The monitor does not operate normally following the operating instructions. Adjust only those controls that are covered in the operating instructions. An improper adjustment of other controls may result in damage and often requires extensive work by a qualified technician to restore the monitor to normal operation.
 - The monitor has been dropped or the cabinet has been damaged.
 - The monitor exhibits a distinct change in performance.
 - Snapping or popping from the monitor is continuous or frequent while the monitor is operating. It is normal for some monitors to make occasional sounds when being turned on or off, or switching video modes.
2. Do not attempt to service the monitor yourself, as opening or removing covers may expose you to dangerous voltage or other hazards. Refer all servicing to qualified service personnel.

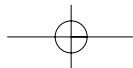

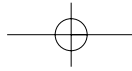

Specifications

Sync Signal type

Type	H. sync	V. sync
Separate sync	H. sync	V. sync

Signal Connector Pin Assignment

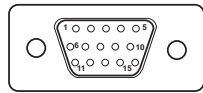

Pin	Separate Sync
1	Red
2	Green
3	Blue
4	Ground
5	Self-Test
6	Red Ground
7	Green Ground
8	Blue Ground
9	NC
10	Ground
11	Ground
12	SDA
13	Horiz.Sync
14	Vert.Sync
15	SCL

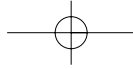

Specifications

- Picture tube** : 14 inch (13.2 inches viewable), Tinted,
90 degree deflection
0.28 mm, Non-Glare screen
- Horizontal Frequency** : 30 ~ 49 kHz
- Vertical Frequency** : 50 ~ 90 Hz
- Display Area** : 260 x 190 mm (H x V)
- Video Bandwidth** : 65 MHz
- Resolution** : 1024 x 768 Non Interlace, 60Hz Refresh Rate
- Signal connector** : 15 pin D-Sub type
- Power input** : AC 100-240V, 50/60Hz, 1.5A

Power Consumption Table

MODE	H.sync	V.sync	Video	Power Consumption	LED Color
Normal	On	On	On	≤ 85W	Green
Stand-by	Off	On	Off	≤ 15W	Amber
Suspend	On	Off	Off	≤ 15W	Amber
Off	Off	Off	Off	≤ 8W	Amber

- Dimensions** : 352 x 397.1 x 307.5 mm (With Tilt/Swivel Stand))
(WXDXH) 13.9 x 15.6 x 12.1 inch
- Weight (net)** : 10.5 kg (23.15 lbs)

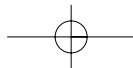

Compliances

Federal Communications Commission(FCC) Statement

This equipment has been tested and found to comply with the limits for a Class B digital device, pursuant to Part 15 of the FCC Rules. These limits are designed to provide reasonable protection against harmful interference in a residential installation. This equipment generates, uses and can radiate radio frequency energy and, if not installed and used in accordance with the instructions, may cause harmful interference to radio communications. However, there is no guarantee that interference will not occur in a particular installation.

If this equipment does cause harmful interference to radio or television reception, which can be determined by turning the equipment off and on, the user is encouraged to try to correct the interference by one or more of the following measures:

- Reorient or relocate the receiving antenna.
- Increase the separation between the equipment and receiver.
- Connect the equipment into an outlet on a circuit different from that to which the receiver is connected.
- Consult an IBM authorized dealer or service representative for help.

Properly shielded and grounded cables and connectors must be used in order to meet FCC emission limits. Proper cables and connectors are available from IBM authorized dealers. IBM is not responsible for any radio or television interference caused by using other than recommended cables and connectors or by unauthorized changes or modifications to this equipment. Unauthorized changes or modifications could void the user's authority to operate the equipment.

This device complies with Part 15 of the FCC Rules. Operation is subject to the following two conditions: (1) this device may not cause harmful interference, and (2) this device must accept any interference received, including interference that may cause undesired operation.

Industry Canada Compliance Statement

This Class B digital apparatus meets the requirements of the Canadian Interference-Causing Equipment Regulations.

Cet appareil numérique de la Classe B respecte toutes les exigences du Règlement sur le matériel brouilleur du Canada.

Compliances

Power Cord:

For your safety, IBM provides a power cord with a grounded attachment plug to use with this IBM product. To avoid electrical shock, always use the power cord and plug with a properly grounded power outlet.

IBM power cords used in the United States and Canada are listed by the Underwriters Laboratories (UL) and certified by the Canadian Standards Association (CSA).

For units intended to be operated at 115 volts: Use a UL listed and CSA certified cord set consisting of a minimum 18 AWG, type SVT or SJT, three conductor cord, a maximum of 4.5 metres (15 feet) in length and a parallel blade, grounding type attachment plug rated 15 amperes, 125 volts.

For units intended to be operated at 230 volts (U.S. use): Use a UL listed and CSA certified cord set consisting of a minimum 18 AWG, type SVT or SJT, three conductor cord, a maximum of 4.5 metres (15 feet) in length and a tandem blade, grounding type attachment plug rated 15 amperes 250 volts.

For units intended to be operated at 230 volts (outside the U.S.): Use a cord set with a grounding type attachment plug rated 13 amperes (minimum), 250 volts. The cord set should be marked <HAR> and have the appropriate safety approvals for the country in which the equipment will be installed.



As an ENERGY STAR® Partner IBM Corporation has determined that this product meets the ENERGY STAR® guidelines for energy efficiency.

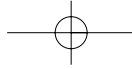

Compliances

MPR II

This product complies with Swedish National Council for Metrology (MPR) standards issued in December 1990 (MPR II) for very low frequency (VLF) and extremely low frequency (ELF).

European Union (EU) Statement

This product has been tested and found to comply with the limits for Class B Information Technology Equipment according to CISPR 22/ European Standard EN 55022. The limits for Class B equipment were derived for typical residential environments to provide reasonable protection against interference with licensed communication devices. Properly shielded and grounded cables and connectors must be used in order to reduce the potential for causing interference to radio and TV communications and to other electrical or electronic equipment. Such cables and connectors are available from IBM authorized dealers. In accordance with EN 50082-1 1992, Performance Criterion A, it should be noted that in the presence of certain electromagnetic fields, some screen jitter may be observed.

Service Information

The following parts are for use by IBM service, or IBM authorized dealers, to support customer warranty. Parts are for service use only.

Model Type 2268

Part Number	M/T-Model	Description
04N7322	2268-06E	Monitor-UVNH (pearl white)
04N7323	2268-46E	Monitor-UVNH (stealth black)

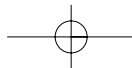

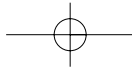

Warranty

Statement of Limited Warranty

The warranties provided by IBM in this Statement of Limited Warranty apply only to Machines you originally purchase for your use, and not for resale, from IBM or your reseller. The term "Machine" means an IBM machine, its features, conversions, upgrades, elements, or accessories, or any combination of them. Unless IBM specifies otherwise, the following warranties apply only in the country where you acquire the Machine. If you have any questions, contact IBM or your reseller.

Machine:	A40 (M/T 2268)
Warranty Period*:	Three years
*Contact your place of purchase for warranty service information.	

Production Status

Each Machine is manufactured from new parts, or new and used parts. In some cases, the Machine may not be new and may have been previously installed. Regardless of the Machine's production status, IBM's warranty terms apply.

The IBM Warranty for Machines

IBM warrants that each Machine 1) is free from defects in materials and workmanship and 2) conforms to IBM's Official Published Specifications. The warranty period for a Machine is a specified, fixed period commencing on its Date of Installation. The date on your receipt is the Date of Installation, unless IBM or your reseller informs you otherwise.

During the warranty period IBM or your reseller, if authorized by IBM, will provide warranty service under the type of service designated for the Machine and will manage and install engineering changes that apply to the Machine.

For IBM or your reseller to provide warranty service for a feature, conversion, or upgrade, IBM or your reseller may require that the Machine on which it is installed be 1) for certain Machines, the designated, serial-numbered Machine and 2) at an engineering-change level compatible with the feature, conversion, or upgrade. Many of these transactions involve the removal of parts and their return to IBM. You represent that all removed parts are genuine and unaltered. A part that replaces a removed part will assume the warranty service status of the replaced part.

If a Machine does not function as warranted during the warranty period, IBM or your reseller will repair it or replace it with one that is at least functionally equivalent, without charge. The replacement may not be new, but will be in good working order. If IBM or your reseller is unable to repair or replace the Machine, you may return it to your place of purchase and your money will be refunded.

If you transfer a Machine to another user, warranty service is available to that user for the remainder of the warranty period. You should give your proof of purchase and this Statement to that user. However, for Machines which have a life-time warranty, this warranty is not transferable.

Warranty Service

To obtain warranty service for the Machine, you should contact your reseller or call IBM. In the United States, call IBM at 1-800-772-2227. In Canada, call IBM at 1-800-565-3344. You may be required to present proof of purchase.

IBM or your reseller will provide certain types of repair and exchange service, either at your location or at IBM's or your reseller's service center, to restore a Machine to good working order.

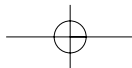

Warranty

When a type of service involves the exchange of a Machine or part, the item IBM or your reseller replaces becomes its property and the replacement becomes yours. You represent that all removed items are genuine and unaltered. The replacement may not be new, but will be in good working order and at least functionally equivalent to the item replaced. The replacement assumes the warranty service status of the replaced item. Before IBM or your reseller exchanges a Machine or part, you agree to remove all features, parts, options, alterations, and attachments not under warranty service. You also agree to ensure that the Machine is free of any legal obligations or restrictions that prevent its exchange.

You agree to:

1. obtain authorization from the owner to have IBM or your reseller service a Machine that you do not own; and
2. where applicable, before service is provided -
 - a. follow the problem determination, problem analysis, and service request procedures that IBM or your reseller provide,
 - b. secure all programs, data, and funds contained in a Machine, and
 - c. inform IBM or your reseller of changes in a Machine's location.

IBM is responsible for loss of, or damage to, your Machine while it is 1) in IBM's possession or 2) in transit in those cases where IBM is responsible for the transportation charges.

Extent of Warranty

IBM does not warrant uninterrupted or error-free operation of a Machine.

The warranties may be voided by misuse, accident, modification, unsuitable physical or operating environment, improper maintenance by you, removal or alteration of Machine or parts identification labels, or failure caused by a product for which IBM is not responsible. THESE WARRANTIES REPLACE ALL OTHER WARRANTIES OR CONDITIONS, EXPRESS OR IMPLIED, INCLUDING, BUT NOT LIMITED TO, THE IMPLIED WARRANTIES OR CONDITIONS OF MERCHANTABILITY AND FITNESS FOR A PARTICULAR PURPOSE.

THESE WARRANTIES GIVE YOU SPECIFIC LEGAL RIGHTS AND YOU MAY ALSO HAVE OTHER RIGHTS WHICH VARY FROM JURISDICTION TO JURISDICTION. SOME JURISDICTIONS DO NOT ALLOW THE EXCLUSION OR LIMITATION OF EXPRESS OR IMPLIED WARRANTIES, SO THE ABOVE EXCLUSION OR LIMITATION MAY NOT APPLY TO YOU. IN THAT EVENT SUCH WARRANTIES ARE LIMITED IN DURATION TO THE WARRANTY PERIOD. NO WARRANTIES APPLY AFTER THAT PERIOD.

Limitation of Liability

Circumstances may arise where, because of a default on IBM's part or other liability you are entitled to recover damages from IBM. In each such instance, regardless of the basis on which you are entitled to claim damages from IBM (including fundamental breach, negligence, misrepresentation, or other contract or tort claim), IBM is liable only for:

1. damages for bodily injury (including death) and damage to real property and tangible personal property; and
2. the amount of any other actual direct damages or loss, up to the greater of U. S. \$100,000 or the charges (if recurring, 12 months' charges apply) for the Machine that is the subject of the claim.

UNDER NO CIRCUMSTANCES IS IBM LIABLE FOR ANY OF THE FOLLOWING: 1) THIRD- PARTY CLAIMS AGAINST YOU FOR LOSSES OR DAMAGES (OTHER THAN THOSE UNDER THE FIRST ITEM LISTED ABOVE); 2) LOSS OF, OR DAMAGE TO, YOUR RECORDS OR DATA; OR 3) SPECIAL, INCIDENTAL, OR INDIRECT DAMAGES OR FOR ANY ECONOMIC CONSEQUENTIAL DAMAGES (INCLUDING LOST PROFITS OR SAVINGS), EVEN IF IBM OR YOUR RESELLER IS INFORMED OF THEIR POSSIBILITY. SOME JURISDICTIONS DO NOT ALLOW THE EXCLUSION OR LIMITATION OF INCIDENTAL OR CONSEQUENTIAL DAMAGES, SO THE ABOVE EXCLUSION OR LIMITATION MAY NOT APPLY TO YOU.

Free Manuals Download Website

<http://myh66.com>

<http://usermanuals.us>

<http://www.somanuals.com>

<http://www.4manuals.cc>

<http://www.manual-lib.com>

<http://www.404manual.com>

<http://www.luxmanual.com>

<http://aubethermostatmanual.com>

Golf course search by state

<http://golfingnear.com>

Email search by domain

<http://emailbydomain.com>

Auto manuals search

<http://auto.somanuals.com>

TV manuals search

<http://tv.somanuals.com>