

 **DANGER**

To avoid shock hazard:

- Do not remove the covers.
- Do not operate this product unless the stand is attached.
- Do not connect or disconnect this product during an electrical storm.
- The power cord plug must be connected to a properly wired and grounded power outlet.
- Any equipment to which this product will be attached must also be connected to properly wired and grounded power outlets.
- To isolate the monitor from the electrical supply, you must remove the plug from the power outlet. The power outlet should be easily accessible.

Handling:

- Your colour monitor is heavy, so handle it with care. If heavier than 18 Kg, IBM recommends that the monitor is moved or lifted by two people.

 **DANGER**

Pour éviter les risques d'électrocution :

- Ne retirez pas les capots du moniteur.
- N'utilisez pas ce produit si le socle n'est pas fixé.
- Ne connectez, ni ne déconnectez ce produit pendant un orage.
- Le câble d'alimentation doit être connecté à une prise électrique correctement mise à la terre et en bon état de marche.
- Tout équipement auquel ce produit est relié doit être également connecté à une prise correctement mise à la terre et en bon état de marche.
- Pour isoler le moniteur de la source d'alimentation électrique, vous devez le débrancher de la prise électrique. Cette prise doit être facile d'accès

Manutention :

- Votre moniteur couleurs est lourd et doit donc être manipulé avec soin. Si son poids dépasse 18 kg, IBM vous conseille de le déplacer ou de le porter à deux.

 **GEFAHRENHINWEIS**

Um die Gefahr eines elektrischen Schlags zu vermeiden, folgendes beachten:

- Unter keinen Umständen die Abdeckungen abnehmen.
- Das Produkt nicht in Betrieb nehmen, wenn der Sockel nicht montiert ist.
- Das Gerät nicht während eines Gewitters an eine Steckdose anschließen oder von ihr trennen.
- Das Netzkabel ist an eine ordnungsgemäß verdrahtete und geerdete Steckdose anzuschließen.
- Jedes Gerät, mit dem dieses Produkt verbunden wird, muß ebenfalls an eine ordnungsgemäß verdrahtete und geerdete Steckdose angeschlossen werden.
- Um den Monitor von der Stromversorgung zu trennen, muß der Stecker aus der Steckdose gezogen werden. Die Steckdose sollte leicht zugänglich sein.

Handhabungshinweis:

- Ihr Farbbildschirm ist schwer, gehen Sie vorsichtig damit um. Wenn er schwerer als 18 kg ist, empfiehlt IBM, daß der Bildschirm von zwei Personen getragen bzw. gehoben wird.

 **GEVAAR**

Ga als volgt te werk om het gevaar van een elektrische schok te voorkomen:

- Verwijder in geen enkel geval de kap.
- Stel dit produkt alleen in werking als de voet is bevestigd.
- Sluit dit apparaat niet aan op, of verbreek de aansluiting van dit apparaat niet van een contactdoos tijdens onweer.
- Het netsnoer moet worden aangesloten op een geaarde contactdoos met correcte bedrading.
- Ook alle apparatuur waarop dit produkt wordt aangesloten moet zijn aangesloten op een contactdoos met correcte bedrading.
- Om het beeldscherm te ontkoppelen van de netvoeding, dient u de stekker uit de contactdoos te trekken. De contactdoos dient goed toegankelijk te zijn.

Verplaatsing:

- De kleurenmonitor is zwaar. Doe dus voorzichtig. Indien de monitor zwaarder is dan 18 kilo, raadt IBM aan de monitor door twee mensen te laten tillen.

 **PELIGRO**

Para evitar riesgos de descargas eléctricas:

- No retire bajo ningún concepto las cubiertas.
- No maneje el monitor sin antes acoplar el soporte.
- No conecte ni desconecte el equipo de una toma de alimentación durante una tormenta eléctrica.
- El cable de alimentación debe estar conectado a un enchufe debidamente cableado y con toma de tierra.
- Cualquier equipo al que se vaya a conectar este producto también debe estar conectado a tomas de alimentación cableadas y conectadas a tierra correctamente.
- Para aislar el monitor del suministro eléctrico, debe retirar el enchufe de la toma de alimentación. Esta toma deberá ser de fácil acceso.

Movimentazione del monitor:

- Il monitor a colori è pesante, si consiglia quindi di maneggiarlo con attenzione. Se il monitor pesa oltre 18 kg, IBM raccomanda che il monitor venga mosso o sollevato da due persone.

 **PERICOLO**

Per evitare il rischio di scariche elettriche:

- Non rimuovere nessuna parte del telaio.
- Non accendere il prodotto se il piedistallo non è stato montato.
- Non collegare o scollegare il prodotto nel corso di un temporale.
- La spina del cavo di alimentazione deve essere collegata ad una presa di corrente con messa a terra, installata in maniera appropriata.
- Le apparecchiature a cui il prodotto viene attaccato devono essere collegate a prese di corrente con messa a terra, installate in maniera appropriata.
- Per isolare il monitor dalla corrente elettrica, staccare la spina dalla presa di alimentazione, che deve essere facilmente accessibile.

Manipulación:

- El monitor de color es pesado, por lo que debe manipularlo con cuidado. Si pesa más de 18 kg, IBM recomienda moverlo con la ayuda de dos personas.

 **PERIGO**

Para evitar o perigo de choques eléctricos:

- Não retire as coberturas.
- Não utilize este produto antes de montar a base.
- Não ligue nem desligue este produto durante uma tempestade eléctrica.
- O cabo de alimentação deve ser ligado a uma tomada eléctrica devidamente ligada à terra.
- Qualquer equipamento ligado a este produto deve estar ligado a tomadas eléctricas devidamente ligadas à terra.
- Para isolar o monitor da fonte de alimentação, retire a ficha do cabo de alimentação da tomada eléctrica. A tomada eléctrica deve ser de fácil acesso.

Manuseio:

- Seu monitor colorido é pesado, então manuseie-o com cuidado. Se o peso for superior a 18 (dezoito) Kg., a IBM recomenda que o monitor seja movido ou carregado por duas pessoas.

 **FARE**

Sådan undgår du elektrisk stød:

- Kabinettet må under ingen omstændigheder fjernes.
- Undgå at anvende dette produkt, uden at vippe/drejefoden er monteret.
- Undgå at tilslutte eller frakoble dette produkt i tordenvejr.
- Netledningen skal være tilsluttet en korrekt jordet stikkontakt med korrekt ledningsføring.
- Alt udstyr, som tilsluttes dette produkt, skal også være tilsluttet korrekt jordede stikkontakter med korrekt ledningsføring.
- For at isolere skærmen fra strømforsyningen, skal stikket tages ud af stikkontakten. Stikkontakten bør være let tilgængelig.

Håndtering:

- Deres farveskærm er tung, så vær forsigtig, når De løfter den. Hvis skærmen vejer mere end 18 kg, anbefaler IBM, at den flyttes og løftes af to personer.



FARE

Slik unngår du fare for elektrisk støt:

- Ikke ta av dekslene.
- Ikke bruk produktet dersom sokkelen ikke er montert.
- Ikke koble produktet til eller fra under tordenvær.
- Pluggen på strømledningen må kobles til korrekt montert og jordet strømuttak.
- Utstyr som dette produktet eventuelt blir koblet til, må også kobles til korrekt montert og jordet strømuttak.
- For å isolere skjermen fra strømkilden må du ta ut pluggen fra strømuttaket. Strømuttaket bør være lett tilgjengelig.

Käsittely:

- Värinäyttö on painava, joten käsittelyä sitä varten. Jos näyttö painaa enemmän kuin 18 kg, IBM suosittelee, että kaksi henkilöä siirtää tai nostaa sitä.



Varning - livsfara

För att undvika risk för elektriska stötar måste du tänka på följande:

- Ta inte bort några skyddskåpor.
- Använd inte den här produkten innan du har satt fast stativet.
- Anslut inte produkten till ett eluttag under åskväder. Koppla inte heller ur produkten från ett eluttag under åskväder.
- Strömkabeln måste anslutas till ett felfritt och jordat uttag.
- All utrustning som den här produkten kopplas till måste också anslutas till felfria och jordade uttag.
- För att bryta strömmen till bildskärmen måste du dra ut kontakten. Väggtaget bör vara lätt att komma åt.

Hantering:

- Hantera din färgmonitor med försiktighet, den är tung. Ni bör vara två personer för att lyfta och flytta monitorn om den är tyngre än 18 kg.



VAARA

Sähköiskun vaaran välttämiseksi:

- Älä avaa laitteen kansia missään tilanteessa.
- Älä käytä laitetta, ellei jalustaa ole kiinnitetty.
- Älä kytke laitetta pistorasiaan tai irrota sitä pistorasiasta ukonilman aikana.
- Virtajohto on kytkettävä asianmukaisesti johdotettuun ja maadoitettuun pistorasiaan.
- Kaikki muutkin laitteet, joihin tämä tuote on liitetty, on kytkettävä asianmukaisesti johdotettuihin pistorasioihin.
- Kun haluat erottaa näyttimen sähköverkosta, sinun pitää irrottaa sen verkkojohto pistorasiasta. Pistorasian pitäisi olla mahdollisimman lähellä näyttintä ja vaivattomasti käsillä.

Håndtering:

- Fargeskjermen din er tung, og må håndteres med varsomhet. Hvis den veier mer enn 18 kilo, anbefaler IBM at skjermen flyttes eller løftes av to personer.



ΚΙΝΔΥΝΟΣ

Για την αποφυγή κινδύνου ηλεκτροπληξίας:

- Μην αφαιρείτε τα καλύμματα.
- Μη θέτετε το προϊόν αυτό σε λειτουργία χωρίς να είναι στερεωμένη η βάση του.
- Μη συνδέετε ή αποσυνδέετε το προϊόν αυτό κατά τη διάρκεια ηλεκτροθύελλας.
- Το φως του καλωδίου ρευματολήπτη πρέπει να συνδεθεί σε μια πρίζα με σωστή καλωδίωση και γείωση.
- Κάθε συσκευή στην οποία συνδεθεί αυτό το προϊόν πρέπει επίσης να συνδεθεί σε πρίζα με σωστή καλωδίωση και γείωση.
- Για να απομονώσετε την οθόνη από την παροχή ρεύματος, πρέπει να αφαιρέσετε το φως από την πρίζα. Η πρίζα πρέπει να είναι σε σημείο εύκολα προσβάσιμο.

Χειρισμός:

- Η έγχρωμη οθόνη σας είναι βαριά, γι'αυτό χειριστείτε την με προσοχή. Η IBM συνιστά η οθόνη να μεταφέρεται ή να σηκώνεται από δύο άτομα.



TEHLIKE

Elektrik arpmasý tehlikesinden kaýnmak iin:

- Kapaklarý ýkarmayýnýz.
- Bu cihazý kaidesine takýlý durumda deđilken alýþtýrmaýnýz.
- Bu cihazý elektriksel fýrtýna sýrasýnda prize takmaýnýz veya prizden ýkarmayýnýz.
- Elektrik kablosunun fiþi, elektrik ve toprak bađlantýlarý usulüne uygun olarak yapýlmýþ bir prize takýlmalýdýr.
- Bu cihazýn bađlanacađý diđer tüm cihazlar da elektrik ve toprak bađlantýlarý usulüne uygun olarak yapýlmýþ prize takýlmýþ olmalýdýr.
- Monitörün elektrikle bađlantýsýný kesmek iin fiþini prizden ekmeniz gereklidir. Priz, kolayca eriþilebilecek bir yerde olmalýdýr.

Kaldýrma

- Renkly monitörünüz ađýr olduđu icin kaldýrýrken dikkatli olunuz. IBM, monitörün ađýrlýđýnýn 18 kilogramdan fazla olmasý halinde iki kiþi tarafýndan taþýnmasýný veya kaldýrýlmasýný tavsiye etmektedir.



OPREZ

Da biste izbjegli opasnost od strujnog udara:

- Nemojte otvarati kucište uredaja.
- Nemojte upotrebljavati ovaj uredaj dok ne postavite postolje.
- Nemojte spajati i odspajati uredaj za vrijeme oluje.
- Naponski kabel mora biti priključen u odgovarajuće uzemljenu uticnicu.
- Bilo koja oprema na koju se ovaj uredaj bití spojen takoder mora biti priključen u odgovarajuće uzemljenu uticnicu.
- Da biste isključili uredaj iz struje, iskopcajte utikac iz uticnice. Uticnica treba biti lako dostupna.

Rukovanje:

- Vaš monitor je te ak, zato rukujte njime pa ljiivo. IBM preporua da ovaj monitor podi u ili pomicu dvije osobe.



ВНИМАНИЕ!

За да избегнете риск от токов удар:

- Не махайте предпазните капаци.
- Не използвайте продукта, освен ако не е закачена стойката.
- Не свързвайте и не разкачайте този продукт по време на гръмотевична буря.
- Куплунгът на кабела за захранване трябва да бъде свързан към правилно окабелен и заземен контакт.
- Всяко оборудване, към което този продукт ще се свързва, също трябва да бъде свързано към правилно окабелени и заземени контакти.
- За да изолирате монитора от електрическото захранване, трябва да извадите куплунга от контакта. Контактът трябва да бъде лесно достъпен.

Местене:

- Вашият цветен монитор е тежък, така че местете го внимателно. IBM препоръва мониторът да се носи от двама души.



Nebezpečí

Abyste zabránili nebezpečí úrazu elektrickým proudem:

- Neodstraňujte kryty.
- Nepoužívejte tento produkt, pokud není umístěn na příslušném podstavci.
- Nepřipojujte ani neodpojujte produkt za bouřky.
- Napájecí kabel smí být připojen pouze do řádně zapojené elektrické zásuvky.
- Veškerá zařízení, ke kterým je tento produkt připojen, smějí být rovněž připojena pouze do řádně zapojené zásuvky.
- Abyste odpojili monitor od zdroje elektrické energie, musíte odpojit elektrickou zástrčku ze zásuvky. Zásuvka by měla být umístěna tak, aby byla snadno přístupná.

Přeprava:

- Váš barevný monitor je těžký. Přenášejte ho proto opatrně. Pokud je monitor těžší než 18 kg, doporučuje IBM, aby byl monitor přenášen nebo zvedán dvěma osobami.



Veszély!

Az áramütés elkerülése érdekében:

- Ne távolítsa el a burkolatot.
- Ne üzemeltesse a monitort a talp felszerelése nélkül.
- Villámlással kísért vihar idején ne csatlakoztassa a monitort az elektromos hálózatra, illetve arról ne válassza le.
- Az elektromos kábel csatlakozóját csak szabályosan bekötött és földelt dugaszolóaljzathoz csatlakoztassa.
- Csak olyan berendezéshez kapcsolja a monitort, amely szintén szabályosan bekötött és földelt dugaszolóaljzathoz van csatlakoztatva.
- A monitor áramellátásának megszüntetéséhez húzza ki az elektromos kábel csatlakozóját a dugaszolóaljzataból. A dugaszolóaljzatnak könnyen hozzáférhetőnek kell lenni.

Mozgatás:

- Ez a színes monitor nehéz, ezért kérjük, óvatosan kezelje. Az IBM azt tanácsolja, hogy mozgatását lehetőség szerint két ember végezze, ha súlya meghaladja a 18 kg-ot.



UWAGA NIEBEZPIECZENSTWO!

Aby uniknac porazenia pradem elektrycznym:

- Nie należy otwierac obudowy.
- Nie korzystac z urzadzenia bez zamontowanej podstawki.
- Nie należy podlaczac ani odlaczac urzadzenia podczas burzy z wyładowaniami elektrycznymi.
- Kabel zasilajacy musi byc podlaczony do poprawnie zainstalowanego i uziemionego gniazda elektrycznego.
- Urzadzenia do których bedzie podlaczany ten produkt również musza wykorzystywac poprawnie zainstalowane i uziemione gniazda elektryczne.
- Dla odlaczenia monitora od źródła zasilania nelezy wyciagnac przewód zasilajacy z gniazda elektrycznego. Gniazdo elektryczne musi byc latwo dostepne.

Obsługa:

- Monitor kolorowy jest ciezki, zachowaj ostroznosc przy przenoszeniu. IBM radzi by monitor byl przenoszony przez dwie osoby.

PERICOL!

Pentru a evita riscul unui șoc:

- Nu îndepărtați carcasele
- Nu utilizați acest produs fără a-i atașa suportul
- Nu conectați sau deconectați echipamentul în timpul unei variații de tensiune
- Echipamentul trebuie conectat corect la rețeaua de electricitate, iar priza trebuie să aibă împământare
- Orice alt produs la care va fi atașat echipamentul trebuie să fie conectat asemănător la rețeaua de electricitate, iar priza trebuie să aibă împământare
- Pentru a izola monitorul de sursa electrică, cablul de tensiune trebuie scos din priză. Priza electrică trebuie să fie ușor accesibilă.

Manipulare

- Monitorul color este un echipament greu, deci trebuie manevrat cu atenție. IBM recomandă ca acest monitor să fie mișcat sau ridicat de către două persoane.

ОПАСНО

Чтобы избежать поражения током:

- Не снимайте крышки устройства.
- Не работайте с данным устройством, если оно не установлено на подставку.
- Не подключайте и не отключайте устройство во время грозы.
- Подключайте кабель питания только к надлежащим образом заземленной и правильно подключенной розетке.
- Все оборудование, с которым будет соединено данное устройство, также должно быть подключено только к надлежащим образом заземленным и правильно подключенным розеткам.
- Для отключения монитора от сети необходимо вынуть вилку кабеля питания из розетки. Необходимо обеспечить удобный доступ к розетке.

Внимание:

- Ваш монитор достаточно тяжел, обращаться с ним следует осторожно. IBM рекомендует перемещать и поднимать монитор вдвоем.

Nebezpečnostvo!

Za účelom predchádzania úrazu elektrickým prúdom:

- Neodjímajte kryty produktu.
- Neprevádzkujte produkt pokiaľ nie je pripojený podstavec.
- Nezapájajte alebo neodpájajte tento produkt počas elektrickej búrky.
- Konektor napájacej šnúry musí byť pripojený do správne zapojenej a uzemnenej elektrickej zásuvky.
- Akékoľvek zariadenie ku ktorému bude tento produkt zapojený musí taktiež byť pripojený do správne zapojenej a uzemnenej elektrickej zásuvky.
- Ak treba izolovať monitor od elektrického napätia, je treba odpojiť napájaciu šnúru zo zásuvky.

Zaobchádzanie:

- Váš farebný monitor je ťažký, preto s ním zaobchádzajte opatrne. IBM odporúča aby tento monitor presúvali alebo zdvíhali dve osoby.

NEVARNOST!

Da bi se izognili električnemu udaru:

- Ne odstranjajte pokrova
- Ne vključujte tega izdelka, preden ni pritrjen podstavek
- Med nevihto priklopa ali izklopa izdelka ne priporočamo
- Vtikač napajalnega kabla mora biti priključen s primerno ožičeno
- In ozemljeno napajalno vtičnico
- Katerakoli oprema, na katero povežete ta izdelek, mora biti prav tako priključena na primerno ožičene in ozemljene napajalne vtičnice
- Zato da monitor ločite od električnega napajanja, morate vtikač potegniti iz napajalne vtičnice. Napajalna vtičnica mora biti lahko dostopna.

Ravnanje z monitorjem:

- Vaš barvni monitor je težak, zato z njim ravnajte še posebej previdno. IBM priporoča, da ta monitor premikata ali dvigata po dve osebi hkrati.

危险

为避免电击危险:

- 不可卸下外壳。
- 不可在未装上支架的情况下操作本产品。
- 不可在雷暴期间连接或断开连接本产品。
- 电源线插头必须连接到正确连线并妥善接地的电源插座。
- 本产品将要连接到的任何设备也必须连接到正确连线并妥善接地的电源插座。
- 要断开显示器的供电，必须从电源插座上拔下插头。电源插座必须可以方便地触及到。

搬运:

- 彩色显示器很重，所以请搬运时小心。如果重量大于 18 Kg，IBM 建议由两个人来移动或抬起显示器。

危險

為了避免撞擊：

- 請勿移除外殼。
- 一定要有支架才能使用此產品。
- 在電擊時請勿連接此產品或將此產品解除連接。
- 電源線插頭必需連接適當的電線並插入適當的接地電源插頭。
- 任何要與此產品連接的設備都必需連接適當的電線並插入適當的接地電源插頭。
- 如果要切斷螢幕的電源，請找出插座上的插頭。電源插座應該很容易買到。

搬動：

- 我們的彩色螢幕很重，所以搬動時要很小心。如果重量超過 18 公斤，IBM 建議要

⚠ 危険

感電を防止するため：

- * カバーを取り除かないでください。
- * スタンドを取り付けしないで本製品を操作しないでください。
- * 雷の発生時には、本製品の取り付けまたは取り外しを行わないでください。
- * 電源コードは正しく配線および接地された電源に接続してください。
- * 本製品が接続されるすべての装置もまた正しく配線および接地された電源に接続されている必要があります。
- * このモニターを電源から切り離すためには、コンセントから電源プラグを抜く必要があります。コンセントは使用しやすい場所に配置されている必要があります。

⚠ 위험

전기 충격을 피하려면,

- 제품의 덮개를 제거하지 마십시오.
- 스탠드가 부착되어 있지 않으면 이 제품을 작동시키지 마십시오.
- 뇌우를 동반할 때는 제품을 연결하거나 분리하지 마십시오.
- 전원 코드를 올바르게 배선 및 접지된 콘센트에 연결해야 합니다.
- 이 제품에 연결할 모든 장비는 올바르게 배선 및 접지된 콘센트에 연결되어 있어야 합니다.
- 모니터를 전기 공급 장치에서 분리시키려면, 콘센트에서 플러그를 제거해야 합니다. 콘센트는 접근하기 쉬운 곳에 있어야 합니다.

취급:

- 저희 컬러 모니터는 무거우므로 주의해서 다루십시오. IBM은 모니터의 무게가 18Kg 이상일 때 두 사람이 움직이거나 들어올릴 것을 권장합니다.

⚠ خطر

لتجنب الخطورة:

- لا تقم بنزع الغطاء.
- لا تقم بتشغيل هذا المنتج ما لم يتم توصيل الحامل.
- لا تقم بتوصيل أو فصل هذا المنتج أثناء سريان التيار الكهربائي.
- يجب توصيل السلك الكهربائي بمخرج تيار كهربائي تم توصيل أسلاكه أرضياً بطريقة صحيحة.
- قم بتوصيل أي أجهزة يتم ارفاقها بهذا المنتج بمخارج كهربائية تم توصيل أسلاكها أرضياً بطريقة صحيحة.
- لعزل الشاشة عن المصدر الكهربائي، يكون من الضروري أن تقوم بنزع القابس من المخرج الكهربائي. بحيث يكون من السهل استخدام المخرج الكهربائي.
- طريقة رفع الشاشة:
 - تعد الشاشة الخاصة بك ثقيلة، لذلك، يجب توخي الحذر عند رفعها. إذا كان وزن الشاشة يتعدى 18 كجم، ستطلب شركة IBM أن يقوم شخصان برفع أو تحريك الشاشة.

סכנה

כדי למנוע סכנת התחשמלות:

- אין להסיר את המכסה ;
- אין להפעיל את הצג אלא לאחר חיבור הבסיס בלבד ;
- אין לחבר או לנתק את הצג לרשת החשמל בעת סופת ברקים ;
- יש לחבר את כבל הכוח לשקע חשמלי תקני המצויד בהארקה ;
- מכשיר שמחובר למוצר זה יהיה מחובר אף הוא לשקע חשמלי תקני המצויד בהארקה ;
- כדי לבדוד את הצג ממקור הכוח, יש לנתק את התקע מהשקע החשמלי. יש לדאוג שהשקע החשמלי יהיה נגיש בקלות.

העברת הצג ממקומו:

- הצג הצבעוני כבד, ולכן יש לטפל בו בזהירות. אם משקל הצג עולה על 18 ק"ג, מומלץ להעבירו או להרימו בעזרת שני אנשים.

First Edition (November 2000)

This publication could contain technical inaccuracies or typographical errors. Changes are made periodically to the information herein; these changes will be made in later editions. IBM may make improvements and/or changes in the product(s) and/or program(s) at any time.

It is possible that this publication may contain reference to, or information about, IBM products (machines and programs), programming, or services that are not announced in your country.

Requests for copies of this publication and for technical information about IBM products should be made to your IBM Authorized Dealer or IBM Retailer.

No part of this publication may be reproduced or distributed in any form or by any means without prior permission in writing from the International Business Machines Corporation.

**© Copyright International Business Machines Corporation 2000.
All rights reserved.**

Note to U.S. Government Users -- Documentation related to restricted rights -- Use, duplication or disclosure is subject to restrictions set forth in GSA ADP Schedule Contract with IBM Corp.

Notices

References in this publication to IBM products, programs, or services do not imply that IBM intends to make these available in all countries in which IBM operates. Any reference to an IBM product, program or service is not intended to state or imply that only IBM's product, program, or service may be used. Any functionally equivalent product, program, or service that does not infringe any of IBM's intellectual property rights or other legally protectable rights may be used instead of the IBM product, program, or service. Evaluation and verification of operation in conjunction with other products, programs, or services, except those expressly designated by IBM, are the user's responsibility.

IBM may have patents or pending patent applications covering subject matter in this document. The furnishing of this document does not give you any license to these patents.

Trademarks

The following terms, used in this publication, are trademarks or service marks of the IBM Corporation in the United States, other countries, or both:

HelpCenter IBM

ENERGY STAR is a U.S. Govt. registered trademark.

Microsoft and Windows are trademarks of Microsoft Corporation in the United States, other countries, or both.

Other company, product, and service names may be trademarks or service marks of others.

Contents

Packing list -----	3
Precautions -----	4
Installation Instructions -----	5
Swivel Base -----	5
Power cord -----	6
Video cable -----	6
Operating Instructions -----	7
General Instructions -----	7
How to adjust a setting -----	8
Adjusting the picture -----	9
Features -----	10
Green monitor -----	10
Plug and play -----	11
Technical Support (FAQ) -----	12
Appendix A – Specifications -----	14-15
Appendix B – Factory Preset Timing Table -----	16

PACKING LIST

The product package should include the following items:

1. Monitor
2. Owner's manual
3. Power cord
4. Swivel base
5. Diskette

PRECAUTIONS

Workplace preparation

Positioning the monitor

Choose a suitable place to position the monitor where it is not near fluorescent desk lighting or any equipment that produces magnetic fields that could cause interference. Ensure that the furniture or equipment can support the weight of the monitor. Allow at least 2 in. (50 mm) ventilation space around the monitor.

Height

The monitor should be positioned so that the top of the screen is slightly below your eye level when you sit at your workstation.

Orientation

Choose a position that gives the least reflection from lights and windows, usually at a right angle to any windows. Position the monitor directly in front of you so that you do not have to twist your body. Tilt the monitor to a comfortable viewing angle.

Working Practices

Rest

Take regular breaks. Vary your posture, and stand up and stretch occasionally, as prolonged use of computer workstations can be tiring.

Back

Sit back in the chair and use the back rest.

Hands

Use a light touch on the keyboard, keeping your hands and fingers relaxed. Allow a space in front of the keyboard to rest your wrists when not typing. Consider using a wristpad.

Eyesight

Working with monitors, in common with any prolonged close work, can be visually demanding. Look away from the screen periodically and have your eyesight checked regularly.

Screen settings

Set the screen brightness and contrast to a comfortable level. You might have to adjust this as the lighting changes during the day. Many application programs let you select color combinations which can help you to view in comfort.

INSTALLATION INSTRUCTIONS

Swivel Base

To attach the swivel base to the monitor, do the following:

- Carefully turn the monitor on its side or upside down. (see figure 1)
- Locate the cavities at the bottom front of the monitor.
- Insert the pegs on the swivel base into these cavities. Push the swivel base forward until the swivel base locks in place.
- To remove the swivel base, hold the bottom of the swivel base, and then push it out.

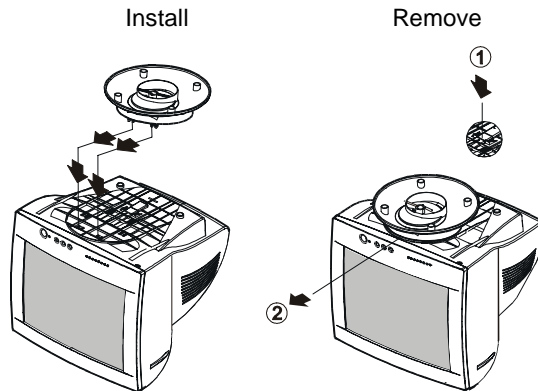

Figure 1 Installing and removing the Swivel Base

Power Source:

1. Make sure the power cord is the correct type that is required in your area.
2. This monitor has a universal power supply that allows operation in 100/120V ac or 220/240V ac voltage (No user adjustment is required)
3. Connect the power cord into your monitor's power input socket, and then plug the other end into a 3-pin ac power outlet. The power cord can be connected to either a wall power outlet or the power outlet socket on your computer, depending on the type of power cord supplied with your monitor.

Power cord:

For safe operation, use the power cord supplied with the unit.

Video cable

Connecting the video cable: The monitor comes with a built-in video cable. Plug the signal cable's 15-pin connector into the computer's video port and tighten the two screws on the cable connector. (see figure 2)

Connecting the power cord: Plug the power cord into the monitor's ac power socket. Then plug the power cord into a grounded ac outlet or UL-approved power strip or the power output socket on your computer.

Caution: *If the AC outlet is not grounded(only two holes), install the proper grounding adapter (not supplied).*

Diskette: The Installation Diskette included with your monitor contains information that you might need for its use. Refer to the readme file on this diskette.

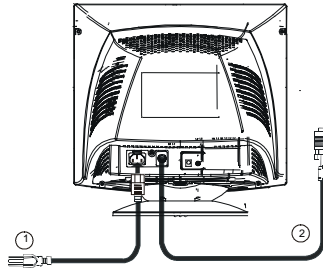

Figure 2 Connecting cables

1.	Power Cord	2.	Signal Cable
----	------------	----	--------------

OPERATING INSTRUCTIONS

General Instructions

The power switch is located at front panel of the monitor. Press the power switch to turn the monitor on or off. The other controls are located at the base of the monitor (See Figure 3). By changing these settings, the picture can be adjusted to your personal preferences.

- The power cord must be connected.
- Connect the video cable from the monitor to the System/Video card.
- To turn the monitor on, press the POWER switch to ON position. The power indicator will light up.

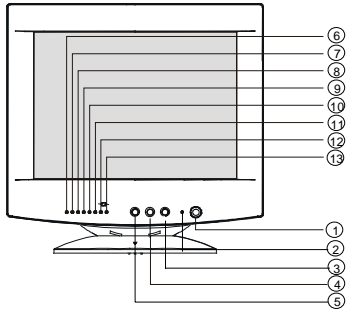

Figure 3 External Controls

External Controls

Switch:		Functions:			
1.	Power On/Off Switch	6.	Contrast	11.	V-Center
2.	LED	7.	Brightness	12.	Pincushion
3.	Up Key	8.	H-Size	13.	Trapezoid
4.	Down Key	9.	H-Center	12+13.	Rotation
5.	Function Key	10.	V-Size		

Notes











- Do not install the monitor in a location near heat sources such as radiators or air ducts , or in a place subject to direct sunlight , or excessive dust or mechanical vibration or shock.
- Save the original shipping carton and packing materials, as they will come in handy if you ever have to ship your monitor.
- To keep the monitor looking new, periodically clean it with a soft cloth. Stubborn stains may be removed with a cloth lightly dampened with a mild detergent solution. Never use strong solvents such as thinner, benzene, or abrasive cleaners, since these will damage the cabinet. As a safety precaution, always unplug the monitor before cleaning it.

How to adjust a setting

1. Press the ON/OFF button, the green LED lights and the power is ON.
Press this ON/OFF button again, the green LED disappear and the power is OFF.
2. When press the “FUNC” key, the LED will flash to indicate the function has been selected.
3. When function has been selected, press to adjust picture image.
4. Press the “FUNC” key until the LEDs of pincushion and trapezoid flash simultaneously, then press Up or Down key to adjust the picture tilt to horizontal position.

Adjusting the picture

The description for function control LEDS

1.		CONTRAST	Adjust the picture contrast.
2.		BRIGHTNESS	Adjust the picture brightness.
3.		H-SIZE	Adjust the picture's horizontal size.
4.		H-CENTER	Adjust the horizontal position of the picture.
5.		V-SIZE	Adjust the picture's vertical size.
6.		V-CENTER	Adjust the vertical position of the picture.
7.		PINCUSHION	Adjust the pincushion and barrel.
8.		TRAPEZOID	Adjust the picture's trapezoid distortion.
9.		ROTATION	Adjust the picture tilt to horizontal position.
10.		RECALL	To recall original factory preset mode.

FEATURES

Green monitor

- The monitor has a power saving function that conforms to the VESA DPMS standard. This feature will only work if your computer is a “green” computer. This feature will switch off your monitor to conserve energy, after a user-specified period of inactivity.

To activate this feature in Microsoft® Windows® 98:

In Windows® 98, this feature can be activated and customized under the screen saver setting of the display properties.

1. Using the right mouse button, click the desktop and then select Properties.
 2. Click the Screen Saver tab. If your system supports a “green” computer, the Energy Saving Features of Monitor panel displays. If your system does not support a “green” computer, you will have to manually turn off the computer to save energy.
 3. In the Energy Saving Features of Monitor panel, activate the Standby feature by placing a check in the Standby check box or activate the Shut off feature by placing a check in the Shut off check box.
 4. You can specify the amount of inactive time before your monitor enters standby mode or shuts off.
- The power-saving mode is indicated by the light-emitting diode (LED) on the front panel:

Mode	Signal				Power	
	Cable	H-Sync	V-Sync	Video	Indicator	Consumption
On*	Attached	Yes	Yes	Active	Green	≤ 75 W
Stand-by	Attached	No	Yes	Blank	Orange	≤ 15 W
Suspend	Attached	Yes	No	Blank	Orange	≤ 15 W
Off	Attached	No	No	Blank	Orange	≤ 8 W

THIS MONITOR WILL APPEAR TO BE NON-FUNCTIONAL IF THERE IS NO VIDEO INPUT SIGNAL. IN ORDER FOR THIS MONITOR TO OPERATE PROPERLY, THERE MUST BE A VIDEO INPUT SIGNAL.

This monitor meets the Power Management standards as set by the Video Electronics Standards Association (VESA) and/or the United States Environmental Protection Agency (EPA) and The Swedish Confederation Employees (NUTEK). This feature is designed to conserve electrical energy by reducing power consumption when there is no video input signal present. When there is no video input signal, this monitor, following a time-out period, will automatically switch to an OFF mode. This reduces the monitor's internal power supply consumption. After the video input signal is restored, full power is restored and the display is automatically redrawn. The appearance is similar to a "Screen Saver" feature except the display is completely off. The display is restored by pressing a key on the keyboard, or clicking the mouse.

Plug and play

Plug & Play DDC1/2B Feature

This monitor is equipped with VESA DDC1/2B capabilities according to the VESA DDC STANDARD. It allows the monitor to inform the host system of its identity and, depending on the level of DDC used, communicate additional information about its display capabilities. The communication channel is defined in two levels, DDC1 and DDC2B.

The DDC1 is a unidirectional data channel from the display to the host that continuously transmits EDID information. The DDC2B is a bidirectional data channel based on the I²C protocol. The host can request EDID information over the DDC2B channel.

TECHNICAL SUPPORT (FAQ)

Problem & Question	Possible Solution
Power LED is not on	<ul style="list-style-type: none"> *Verify that the power switch is in the ON position *Power cord must be connected
No Plug & Play	<ul style="list-style-type: none"> *Verify that the computer system is Plug & Play compatible *Verify that the video card is Plug & Play compatible *Verify that the D-15 plug pin of video cable is bent *Make sure the monitor device drivers are installed
No picture	<ul style="list-style-type: none"> *Computer power switch must be in the ON position *Computer video card must be snugly seated in its slot *The signal cable must be completely connected to the computer *Check the color of the power LED indicator. If it is orange, then the monitor and the computer system are in power-saving mode. You need to press your keyboard or move the mouse to reactivate the system.
Picture is fuzzy	*Adjust the Contrast and Brightness Controls.
Picture bounces or a wave pattern is present in the picture	*Move electrical devices that might cause electrical interference.
Monitor is stuck in "Power Saving Mode"	<ul style="list-style-type: none"> *Make sure monitor's video cable is properly connected to the computer. *Inspect monitor's video cable and make sure none of the pins are bent. *Make sure computer is operational by hitting the CAPS LOCK key on the keyboard while observing the CAPS LOCK LED. The LED should either turn ON or OFF after hitting the CAPS LOCK key.
Missing one of the primary colors (RED, GREEN, or BLUE)	*Inspect the monitor's video cable and make sure that none of the pins are bent.

Help and service information

This section contains information on how to obtain online and telephone technical support.

Online technical support

Online technical support is available during the life of your product. Online assistance can be obtained through the Personal Computing Support Web site and the IBM Automated Fax System.

<i>Online technical support</i>	
IBM Personal Computing Support Web site	http://www.ibm.com/pc/support

During the warranty period, assistance for replacement or exchange of defective components is available. In addition, if your IBM option is installed in an IBM computer, you might be entitled to service at your location. Your technical support representative can help you determine the best alternative.

Telephone technical support

Installation and configuration support through the HelpCenter will be withdrawn or made available for a fee, at IBM's discretion, 90 days after the option has been withdrawn from marketing. Additional support offerings, including step-by-step installation assistance, are available for a nominal fee.

If you are unable to correct the problem yourself contact your dealer, retailer, or other IBM authorized service. Support phone numbers are also available by clicking HelpCenter phone list on the IBM support Web page at <http://www.ibm.com/pc/support>

Before calling, please have available as much of the following information as possible:

1. Type, model and serial number from the label on the back of your monitor.
2. Purchase receipt.
3. Description of problem.
4. Computer type and model.
5. System configuration(hardware fitted etc.)
6. System BIOS version number.
7. Operating System and version number
8. Display driver version number.

APPENDIX A – SPECIFICATIONS

CRT	CRT Size	35.5 cm (14 in.), 90° deflection, 29 mm neck
	Viewable Image Size	33.5 cm (13.2 in.), diagonal
	Type	0.28 mm dot pitch.
Input	Video	0.7 Vpp, R,G,B Analog
	Separate Sync.	TTL Level
	H./V.- Sync.	Positive / Negative
Scanning Frequency	H-Frequency	30 - 54 kHz
	V-Frequency	50 - 120 Hz
Max. Resolution		1024 x 768
Video dot rate		65 MHz
Factory Preset mode :		7
User Programmable mode :		12
Power Source		Universal 100 – 240 V ac, 50 Hz / 60 Hz
Operating		0 to 40° C (0 to 104° F)
Humidity		10% to 85% relative, non-condensing
Dimensions	Carton	424 mm (1.39 ft) × 424 mm (1.39 ft) × 455 mm (1.5 ft) (W × H × D)
	Monitor & Base	350 mm (1.14 ft) × 349 mm (1.15 ft) × 377 mm (1.2 ft) (W × H × D)
Weight	Unit (net)	10.4 kg (Net)
	Carton (gross)	12.0 kg (Gross)
Signal Cable:		Attached Mini D-sub 15 Male

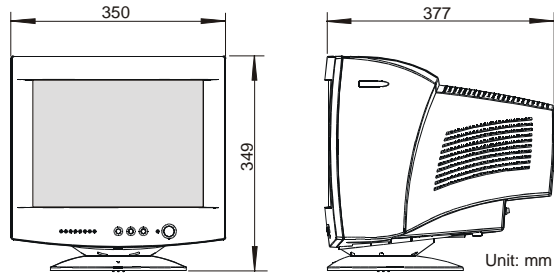

External Controls:	Switch	<ul style="list-style-type: none"> ● Power On/Off switch ● Up/Down Key ● Function Key
	Functions	<ul style="list-style-type: none"> ● Contrast ● Brightness ● H-Size ● H-Center ● V-Size ● V-Center ● Pincushion ● Trapezoid ● Rotation
Plug & Play		DDC1/2B
Power Management		EPA, VESA DPMS
Power Consumption (Maximum)		75 W
Pre-set Display Area		250 mm (9.84 in.) x 187 mm (7.36 in.)
Regulatory Compliance		UL, FCC, CE, MPR II, FDA, CSA

APPENDIX B – FACTORY PRESET TIMING TABLE

STANDARD	RESOLUTION	HORIZONTAL FREQUENCY	VERTICAL FREQUENCY
IBM	720 × 400	31.5 kHz	70 Hz
VGA	640 × 480	31.5 kHz	60 Hz
VESA/75	640 × 480	37.5 kHz	75 Hz
VESA/85	640 × 480	43.3 kHz	85 Hz
VESA/75	800 × 600	46.9 kHz	75 Hz
VESA/85	800 × 600	53.7 kHz	85 Hz
VESA/75	1024 × 768	48.4 kHz	60 Hz

Connector pin assignment

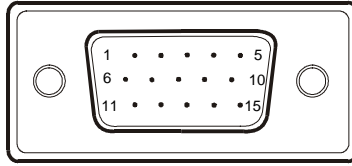

15 - Pin Color Display Signal Cable

PIN NO.	DESCRIPTION	PIN NO.	DESCRIPTION
1.	Red	9.	NC
2.	Green	10.	Ground
3.	Blue	11.	Monitor Ground
4.	Ground	12.	DDC-Serial Data
5.	Ground	13.	H-Sync
6.	R-Ground	14.	V-Sync / ✱V-CLK
7.	G-Ground	15.	DDC-Serial Clock
8.	B-Ground	✱	For DDC

版本1

该版本可能包含了技术上的不精确性或印刷上的错误，故此，将定期进行修改，这些改动将载入到新版本的编辑中，IBM将于任何时候改善和/或变更此版本中述及的产品和/或程序。

该版本可能包含有某些不在您的国家颁布的有关IBM产品程序服务的参考资料或信息。

需要此版本的复印件或有关IBM产品的技术信息，请洽询IBM授权经销商或零售商。

该版本在未经国际商业机器公司预先的书面允许前，不准以任何形式或途径复制和发布。

© 国际商业机器公司版权所有 2000

对美国政府使用人员 -- 文件相关限制权利 -- 使用、复制及泄露限制依先前与IBM所签的GSA ADP Schedule Contract的规定。

注意

该版本里关于IBM产品、程序或服务的参考资料并非意味IBM会使这些资料在所有IBM运作的国家里都能得到。任何涉及IBM的产品、程序或服务,并非说明或意味着只有IBM的产品、程序或服务才可以使用。任何功能相当的产品、程序或服务，只要不侵犯IBM的知识产权或其他受法律保护的权利，均可以使用。使用者应自己负责对非IBM产品、程序或服务进行评估和确认。

在该文件里，IBM可能有覆盖各主要方面的专利或待申请的专利，提供此份印刷品并不提供使用有关专利的权利。

商标

下述应用于该版本的条款是IBM公司在美国或其他国家的商标或服务标记:

IBM

能源之星是美国政府注册标志。

Microsoft及Windows是微软公司在美国其其他国家，或者是两者的商标。

其它公司、产品及服务的名称，可能是他们的商标或服务标记

目录

包装清单 -----	3
预防措施 -----	4
安装说明 -----	5
转盘底座 -----	5
电源线 -----	6
信号线 -----	6
操作说明 -----	7
一般说明 -----	7
前面板控制 -----	7
调整设置 -----	8
调整画面 -----	9
特征 -----	10
绿色显示器 -----	10
即插即用 -----	11
技术支持 (FAQ) -----	12
附录A—规格 -----	14-15
附录B—工厂预置模式表 -----	16

包装清单

包装箱内含有以下物品:

1. 显示器
2. 用户说明书
3. 电源线
4. 转盘底座
5. 安装盘

预防措施

准备工作地点

安置显示器

选择一个合适的位置安置显示器，不要靠近荧光台灯或产生磁场的仪器，它们会引起干涉。确定放置显示器的物体可以承受它的重量。在显示器的周围至少需要两英寸（50毫米）的通风空间。

放置高度

当您坐在您的工作台前，显示器屏幕的顶部要轻微低于您视力的水平位置。

放置方向

选择一个由灯光和窗口反射最少的位置，通常对于任意窗口都应在一个合适的角度。为了不让您转动身体，显示器应放置在您的前方。将显示器倾斜放置到一个视线舒服的位置。

工作实践

休息: 长时间使用计算机时,可使用不同的姿势、站立、伸腰来解乏,从而得到休息。

靠背: 可靠在椅子上坐,并且利用靠背休息

手: 把手轻轻放在键盘上,让手及手指放松,当不必打字时,在键盘前为手腕留一空间,以便手腕休息。(可以考虑使用腕垫)

视觉: 长时间近距离使用显示器,易造成视觉疲劳,要经常把眼睛从显示屏上移开,以保护视力,并定期检查视力。

屏幕设置: 把屏幕亮度及对比度设至最佳状态,许多应用程序允许您选择颜色,这可使您视觉处于最舒适状态。

安装说明

转盘底座

要安装底盘,请照以下的步骤做:

- 小心的把显示器倒过来或侧放(图一)
- 对准显示器底部的卡槽
- 把底盘脚插入卡槽,并把底盘向前压,直到完全被锁定
- 若要拆底盘,则握住底盘,用力按卡勾,直到底座松脱

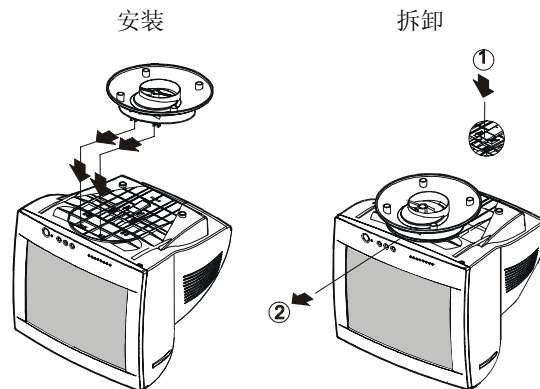

图一 底盘安装

电源:

1. 首先确认该电源线符合您所使用的地区标准。
2. 显示器有较宽的电源电压工作范围, 可适用于100 / 120V AC或220 / 240V AC地区(无需用户调节)。
3. 电源线一端插入显示器电源插座, 另一端接外部三芯插座。

电源线:

为了安全操作, 请使用提供的电源线。

信号线

信号线联接: 本显示器带有一内嵌信号线。把15针插头接PC的显示卡输出口, 并用螺丝锁好。(见图2)

电源线联接: 电源线一端插入显示器后部的插座中, 另一端插PC或墙壁上的电源插座里。

注意: 若电源插座未接地, 必须安装正确的接地适配器(未提供), 以保证安全。

磁盘: 磁盘内包括您在操作显示器时所要了解的信息。请查阅磁盘中自述文件。

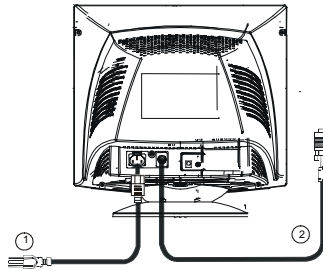

图二 联接线

1.	电源线	2.	信号线
----	-----	----	-----

操作说明

一般说明

电源开关和其它控制按键位于显示器前框面板(见图三)。使用电源开关,可以打开或关闭显示器。通过调节这些按键得到您需要的画面。

- 接好电源线
- 将信号线接到PC机显卡
- 打开显示器把开关打到“ON”的位置,电源指示灯亮

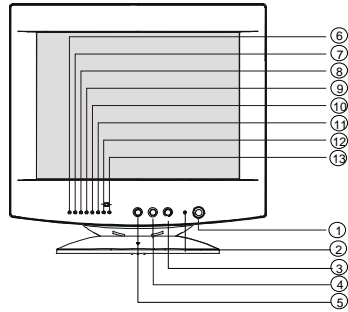

图三 外部控制按键

外部控制

开关:		功能:	
1.	电源开关	6.	对比度
2.	指示灯	7.	亮度
3.	增大键	8.	水平尺寸
4.	减小键	9.	水平中心
5.	功能键	10.	垂直尺寸
		11.	垂直中心
		12.	枕形或桶形失真
		13.	梯形失真
		12+13.	旋转

注意











1. 不要把显示器放在靠近热源的地方，如取暖器、气管或阳光直射的地方。也不要放在灰尘过多或者机械振动、冲击的地方。
2. 保留原来的纸箱包装材料，如果您还要运输您的显示器，它们会给您带来便利。
3. 为保持显示器崭新外观，要定期的用软布来清洁它，顽迹可用柔和的清洁剂去除，不要用强烈的清洁剂，如稀释剂、苯或腐蚀性的清洁剂，因为这些东西会损伤外壳，为安全起见，清洁前要拔掉电源插头。

调整设置

1. 按下电源开关，绿色指示灯亮，电源接通。
再按该键，绿色指示灯熄灭，电源断开。
2. 按下功能键，指示灯闪烁，显示选择的功能。
3. 按大小键调节选择的功能来改变画面。
4. 按功能键直至枕形和梯形两指示灯同时亮，然后按增大或减小键调整画面倾斜偏差。

调整画面

功能描述

1.		对比度	调节画面对比度。
2.		亮度	调节画面亮度。
3.		水平尺寸	调节画面水平尺寸。
4.		水平中心	调节画面水平位置。
5.		垂直尺寸	调节画面垂直尺寸。
6.		垂直中心	调节画面垂直位置。
7.		枕形或桶形失真	调节画面枕形或桶形变化。
8.		梯形失真	调节画面梯形失真。
9.		旋转	调节画面倾斜偏差。
10.		重叫	按重叫键恢复工厂设定值。

特征

绿色显示器

- 本显示器符合VESA DPMS标准的节能功能，如果您的PC是绿色PC，本显示器就能成为绿色显示器。这种现象除了画面完全消失外其它方面都很象屏幕贮存器的特征。

在Microsoft® Windows® 98中激活该特征：

1. 使用鼠标右键点一下工作平台，然后选择属性。
 2. 按下屏幕保护说明键。如果您的系统支持绿色PC，那么显示器省电菜单显显示。如果您的系统没有支持绿色PC，您将必须人工关闭电源来节能。
 3. 在显示器的节能特征部分是两个窗口，节能和关闭。您可以激活任意一个或两个。
 4. 在显示器进入节能状态前，您可以指定或设置显示器处于节能状态或关闭的时间。
- 节能状态可以通过前面板的LED显示：

模式	信号				电源	
	信号线	行信号	场信号	画面	指示灯	消耗功率
开机*	已接	有	有	正常	绿色	≤ 75W
待机	已接	无	有	消隐	橙色	≤ 15W
挂起	已接	有	无	消隐	橙色	≤ 15W
离机	已接	无	无	消隐	橙色	≤ 8W

如果没有视频输入信号，显示器将呈现出无功能状态，为了使显示器能正确操作，必须要有视频输入信号。

本显示器符合视频电子标准协会(VESA)、美国环保机构(EPA)和瑞典雇员组织联盟(NUTEK)规定的能源管理标准，其功能是通过当无视频输入信号时减少能源消耗的方式来节省电能的。在没有视频信号输入显示器时，经过一段时间，将自动切换到“离机”状态，这样就减少了显示器的内部能源消耗。视频输入信号恢复后，所用电量恢复正常且画面会自动重现。这种现象除了画面完全消失外其他方面都很象“屏幕贮存器”的特征。除非显示器彻底被关闭，否则通过按键盘上某一键或按动鼠标可恢复图象。

即插即用

DDC1/2B特征

本显示器配备符合 VESA DDC 标准的 VESA DDC1/2B，这允许显示器将其型号告诉主机，并且，根据DDC使用的标准，传输其显示特性的附加信息。传输通道有两种，DDC1和DDC2B。

DDC1是显示器到主机连续传送EDID信息的单向数据通道，DDC2B是符合PC协定的双向数据通道，主机可以通过DDC2B通道去取得EDID信息。

技术支持 (FAQ)

出现的问题	可能的解决方法
电源指示灯不亮	*是否开电源开关 *是否连接电源线
无法实现即插即用	*是否计算机系统与即插即用匹配 *是否显示卡与即插即用匹配 *是否信号线15针D型接头弯曲 *是否显示器驱动程序已安装
无图象出现	*是否开电源开关 *是否显示卡放置在它的卡槽中 *是否连接信号线 *检查电源指示灯的颜色。如果是橙色，显示器和计算机系统在节能状态。按键盘或移动鼠标重新激活系统。
图象暗淡	*调节对比度和明亮度
图象跳动或出现波纹画面	*可能周边有引起电子干扰的电器设备
显示器一直处于节能状态	*是否显示器的信号线已和计算机连接 *检查显示器信号线插头并确信各引脚没有弯曲 *通过按计算机键盘上的 Caps Lock键观察指示灯，确认计算机是否在操作。
缺色（红、绿、蓝）	*检查显示器的信号线，并确信引脚没有弯曲

支持及服务信息

本节的内容，是关于如何取得在线及电话技术支持方面的信息。

在线技术支持

本公司将在产品使用期间内提供在线技术支持，你可经由个人演算支持网站及IBM自动传真系统获得在线帮助。

在线技术支持	
IBM个人演算支持网站	http://www.ibm.com/pc/support

在保证期间，本公司将提供有关故障元件换新或更换方面的帮助。除此之外，如果你将另行购买IBM组件装配在IBM电脑上时，可能也有权利要求在贵处进行产品服务，本公司的技术支持代表将帮助你决定最佳的选择。

电话技术支持

从取消购买选择起90天内，可依IBM的决定取消经由帮助中心（HelpCenter）所提供的安装及配置支持，或以收费的方式提供。另外也可收取微薄费用的方式，提供额外的支持，其中包括逐步安装方面的帮助。

如果无法自行矫正问题时，请联络当地的经销商、零售商或其他经IBM授权的维修中心。你可经由<http://www.ibm.com/pc/support>的IBM支持网页HelpCenter电话簿上按两次，而取得支持电话号码。

在拨号前，请尽可能了解如下信息：

1. 机型、型号和显示器后壳上标签印刷的序列号。
2. 购买收据。
3. 显示器有什么问题。
4. 计算机的种类和型号。
5. 系统的配置（硬件配置等）。
6. 基本输入输出系统的版本号。
7. 操作系统和版本号。
8. 显卡驱动程序版本号。

附录A—规格

显像管	显像管尺寸	35.5 cm (14 in.), 平面直角, 29 mm 短管颈
	可视尺寸	对角线长33.5 cm (13.2 in.),
	点距	0.28 mm
输入信号	视频信号	模拟红、绿、蓝0.7 V pp
	分离同步	TTL 电平
	水平/垂直同步信号	+/-
扫描频率	行频	30 - 54 kHz
	场频	50 -120 Hz
最高分辨率		1024 x 768
点频		65 MHz
工厂预置模式:		7
用户模式:		12
电源		开关电源, 交流100 - 240 V ac, 50 Hz / 60 Hz
环境温度		0 - 40°C (0 - 104°F)
湿度		相对湿度10% - 85%
尺寸	纸箱	424 mm (1.39 ft) × 424 mm (1.39 ft) × 455 mm (1.5 ft) (W × H × D)
	显示器和底盘	350 mm (1.14 ft) × 349 mm (1.15 ft) × 377 mm (1.2 ft) (W × H × D)
重量	净重	10.4 kg
	毛重	12.0 kg
信号线		15 针小型D型接头

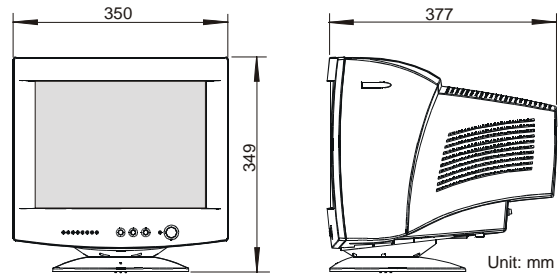

外部控制:	开关	<ul style="list-style-type: none"> ● 电源开关 ● 选择键 ● 功能键
	功能	<ul style="list-style-type: none"> ● 对比度 ● 亮度 ● 水平尺寸 ● 水平中心 ● 垂直尺寸 ● 垂直中心 ● 枕形或桶形失真 ● 梯形失真 ● 旋转
即插即用	DDC1/2B	
节能标准	EPA, VESA DPMS	
功耗	最大75 W	
预设显示尺寸	250 mm (9.84 in.) x 187mm (7.36 in.)	
安规	UL, FCC, CE, MPR II, FDA, CSA	

附录B—工厂预置模式表

标准	分辨率	行频	场频
IBM	720 × 400	31.5 kHz	70 Hz
VGA	640 × 480	31.5 kHz	60 Hz
VESA/75	640 × 480	37.5 kHz	75 Hz
VESA/85	640 × 480	43.3 kHz	85 Hz
VESA/75	800 × 600	46.9 kHz	75 Hz
VESA/85	800 × 600	53.7 kHz	85 Hz
VESA/75	1024 × 768	48.4 kHz	60 Hz

信号线各引脚说明

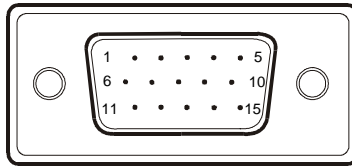

15针彩色显示信号线

引脚	说明	引脚	说明
1.	红	9.	空
2.	绿	10.	接地
3.	蓝	11.	接地
4.	接地	12.	SDA(串行数据/地址线)
5.	接地	13.	水平同步信号
6.	红地	14.	垂直同步信号>(*视频时钟)
7.	绿地	15.	SCL(串行时钟)
8.	蓝地	★	用于 DDC

版本1

該版本可能包含了技術上的不精確性或印刷上的錯誤，故此，將定期進行修改，這些改動將載入到新版本的編輯中，IBM將於任何時候改善和/或變更此版本中述及的產品和/或程式。

該版本可能包含有某些不在您的國家頒佈的有關IBM產品程式服務的參考資料或資訊。

需要此版本的複印件或有關IBM產品的技術資訊，請洽詢IBM授權經銷商或零售商。

該版本在未經國際商業機器公司預先的書面允許前，不准以任何形式或途徑複製和發佈。

© 國際商業機器公司版權所有 2000

對美國政府使用人員 -- 文件相關限制權利 -- 使用、複製及洩露限制依先前與IBM所簽的GSA ADP Schedule Contract的規定。

注意

該版本裏關於IBM產品、程式或服務的參考資料並非意味IBM會使這些資料在所有IBM運作的國家裏都能得到。任何涉及IBM的產品、程式或服務,並非說明或意味著只有IBM的產品、程式或服務才可以使用。任何功能相當的產品、程式或服務，只要不侵犯IBM的知識產權或其他受法律保護的權利，均可以使用。使用者應自己負責對非IBM產品、程式或服務進行評估和確認。

在該文件裏，IBM可能有涵蓋各主要方面的專利或待申請的專利，提供此份印刷品並不提供使用有關專利的權利。

商標

下述應用於該版本的條款是IBM公司在美國其或其他國家的商標或服務標記：

IBM

能源之星是美國政府註冊標誌。

Microsoft及Windows是微軟公司在美國其或其他國家,或者是兩者的商標。其他公司、產品及服務的名稱,可能是他們的商標或服務標記

目錄

包裝清單 -----	3
預防措施 -----	4
安裝說明 -----	5
轉盤底座 -----	5
電源線 -----	6
信號線 -----	6
操作說明 -----	7
一般說明 -----	7
調整設置 -----	8
調整畫面 -----	9
特徵 -----	10
綠色顯示器 -----	10
即插即用 -----	11
技術支援 (FAQ) -----	12
附錄A—規格 -----	14-15
附錄B—工廠預置模式表 -----	16

包裝清單

包裝箱內含有以下物品：

1. 顯示器
2. 用戶說明書
3. 電源線
4. 轉盤底座
5. 安裝盤

預防措施

準備工作地點

安置顯示器

選擇一個合適的位置安置顯示器，不要靠近熒光臺燈或產生磁場的儀器，它們會引起干擾。確定放置顯示器的物體可以承受它的重量。在顯示器的周圍至少需要兩英寸（50毫米）的通風空間。

放置高度

當您坐在您的工作臺前，顯示器螢幕的頂部要稍微低於您視力的水平位置。

放置方向

選擇一個由燈光和窗口反射最少的位置，通常對於任意窗口都應在一個合適的角度。爲了不讓您轉動身體，顯示器應放置在您的前方。將顯示器傾斜放置到一個視線舒服的位置。

工作實踐

休息： 長時間使用電腦時，可使用不同的姿勢、站立、伸腰來解乏，從而得到休息。

靠背： 可靠在椅子上坐，並且利用靠背休息。

手： 把手輕輕放在鍵盤上，讓手及手指放鬆，當不必打字時，在鍵盤前爲手腕留一空間，以便手腕休息。（可以考慮使用腕墊）

視覺： 長時間近距離使用顯示器，易造成視覺疲勞，要經常把眼睛從顯示幕上移開，以保護視力，並定期檢查視力。

螢幕設置： 把螢幕亮度及對比度設至最佳狀態，許多應用程式允許您選擇顏色，這可使您視覺處於最舒適狀態。

安裝說明

轉盤底座

要安裝底盤，請照以下的步驟做：

- 小心的把顯示器倒過來或側放(圖一)
- 對準顯示器底部的卡槽
- 把底盤腳插入卡槽，並把底盤向前壓，直到完全被鎖定
- 若要拆底盤，則握住底盤，用力按卡勾，直到底座鬆脫

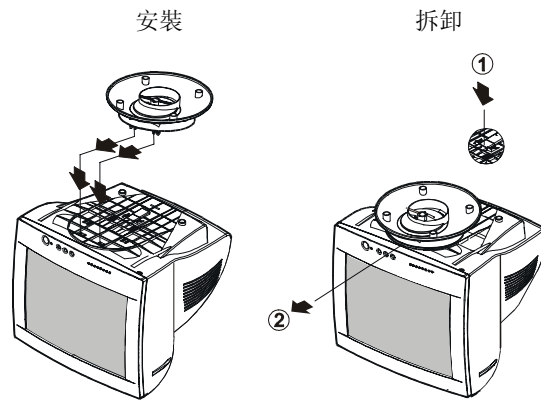

圖一 底盤安裝

電源：

1. 首先確認該電源線符合您所使用的地區標準。
2. 顯示器有較寬的電源電壓工作範圍，可使用於100 / 120V AC或220 / 240V AC地區（無需用戶調節）。
3. 電源線一端插入顯示器電源插座，另一端接外部三芯插座。

電源線：

爲了安全操作，請使用提供的電源線。

信號線

信號線聯接：本顯示器帶有一內嵌信號線。把15針插頭接PC的顯示卡輸出口，並用螺絲鎖好。（見圖二）

電源線聯接：電源線一端插入顯示器後部的插座中，另一端插PC或牆壁上的電源插座裏。

注意：若電源插座未接地,必須安裝正確的接地適配器(未提供),以保證安全。

磁片：磁片內包括您在操作顯示器時所要瞭解的資訊。請查閱磁片中讀我檔案。

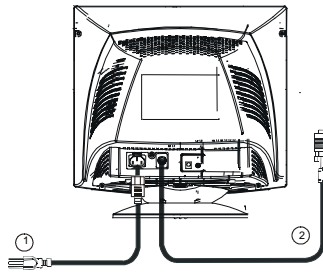

圖二 聯接線

1.	電源線	2.	信號線
----	-----	----	-----

操作說明

一般說明

電源開關和其他控制按鍵位於顯示器前面板（見圖三）。使用電源開關，可以打開或關閉顯示器。通過調節控制按鍵可得到您需要的畫面。

- 接好電源線
- 將信號線接到電腦顯示卡
- 打開顯示器把開關置於“ON”的位置，電源指示燈亮

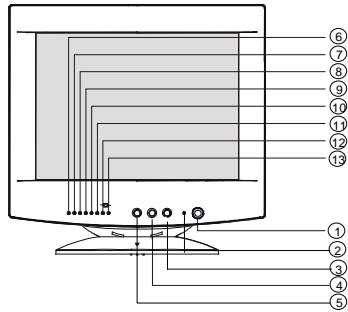

圖三 外部控制按鍵

外部控制

開關:		功能:			
1.	電源開關	6.	對比度	11.	垂直中心
2.	指示燈	7.	亮度	12.	枕形或桶形失真
3.	增大鍵	8.	水平尺寸	13.	梯形失真
4.	減小鍵	9.	水平中心	12+13.	旋轉
5.	功能鍵	10.	垂直尺寸		

注意











1. 不要把顯示器放在靠近熱源的地方，如取暖器、氣管或陽光直射的地方。也不要放在灰塵過多或者機械振動、衝擊的地方。
2. 保留原來的紙箱包裝材料，如果您還要運輸您的顯示器，它們會給您帶來便利。
3. 為保持顯示器嶄新外觀，要定期的用軟布來清潔它，頑漬可用柔和的清潔劑去除，不要用強烈的清潔劑，如稀釋劑、苯或腐蝕性的清潔劑，因為這些東西會損傷外殼，為了安全，清潔前要拔掉電源插頭。

調整設置

1. 按下電源開關，綠色指示燈亮，電源接通。
再按該鍵，綠色指示燈熄滅，電源斷開。
2. 按下功能鍵，指示燈閃爍，顯示選擇的功能。
3. 按大小鍵調節選擇的功能來改變畫面。
4. 按功能鍵直至枕形和梯形兩指示燈同時亮，然後按增大或減小鍵調整畫面傾斜偏差。

調整畫面

功能描述

1.		對比度	調節畫面對比度。
2.		亮度	調節畫面亮度。
3.		水平尺寸	調節畫面水平尺寸。
4.		水平中心	調節畫面水平位置。
5.		垂直尺寸	調節畫面垂直尺寸。
6.		垂直中心	調節畫面垂直位置。
7.		枕形或桶形失真	調節畫面枕形或桶形變化。
8.		梯形失真	調節畫面梯形失真。
9.		旋轉	調節畫面傾斜偏差。
10.		重叫	按重叫鍵恢復工廠設定值。

特徵

綠色顯示器

- 本顯示器符合 VESA DPMS 標準的節能功能，如果您的PC是綠色PC，本顯示器就能成為綠色顯示器。這種現象除了畫面完全消失外其他方面都很像螢幕貯存器的特徵。

在Microsoft® Windows® 98中啟動該特徵：

1. 使用滑鼠右鍵點一下工作平臺，然後選擇屬性。
 2. 按下螢幕保護說明鍵。如果您的系統支援綠色PC，那麼顯示器省電功能表會顯示。如果您的系統沒有支援綠色PC，您將必須人工關閉電源來節能。
 3. 在顯示器的節能特徵部分是兩個視窗，節能和關閉。您可以啟動任意一個或兩個。
 4. 在顯示器進入節能狀態前，您可以指定或設置顯示器處於節能狀態或關閉的時間。
- 節能狀態可以通過前面板的LED顯示：

模式	信號				電源	
	信號線	行信號	場信號	畫面	指示燈	消耗功率
開機*	已接	有	有	正常	綠色	≤ 75W
待機	已接	無	有	消隱	橙色	≤ 15W
暫停	已接	有	無	消隱	橙色	≤ 15W
關機	已接	無	無	消隱	橙色	≤ 8W

如果沒有視頻輸入信號，顯示器將呈現出無功能狀態，為了使顯示器能正確操作，必須要有視頻輸入信號。

本顯示器符合視頻電子標準協會 (VESA)、美國環保機構 (EPA) 和瑞典雇員組織聯盟 (NUTEK) 規定的能源管理標準，其功能是通過當無視頻輸入信號時減少能源消耗的方式來節省電能的。在沒有視頻信號輸入顯示器時，經過一段時間，將自動切換到“待機”狀態，這樣就減少了顯示器的內部能源消耗。視頻輸入信號恢復後，所用電能恢復正常且畫面會自動重現。這種現象除了畫面完全消失外其他方面都很象“螢幕貯存器”的特徵。除非顯示器徹底被關閉，否則通過按鍵盤上某一鍵或按動滑鼠可恢復圖像。

即插即用

DDC1/2B特徵

本顯示器配備符合 VESA DDC 標準的 VESA DDC1/2B，這允許顯示器將其型號告訴主機，並且，根據 DDC 使用的標準，傳輸其顯示特性的附加資訊。傳輸通道有兩種，DDC1 和 DDC2B。

DDC1 是顯示器到主機連續傳送 EDID 資訊的單向資料通道，DDC2B 是符合 PC 協定的雙向資料通道，主機可以通過 DDC2B 通道去取得 EDID 資訊。

技術支援 (FAQ)

出現的問題	可能的解決方法
電源指示燈不亮	*是否開電源開關 *是否連接電源線
無法實現即插即用	*是否電腦系統與即插即用匹配 *是否顯示卡與即插即用匹配 *是否信號線15針D型接頭彎曲 *是否顯示器驅動器程式已安裝
無圖像出現	*是否開電源開關 *是否顯示卡放置在它的卡槽中 *是否連接信號線 *檢查電源指示燈的顏色。如果是橙色，顯示器和電腦系統在節能狀態。按鍵盤或移動滑鼠重新啟動系統。
圖像暗淡	*調節對比度和明亮度
圖像跳動或出現波紋畫面	*可能周邊有引起電子干擾的電器設備
顯示器一直處於節能狀態	*是否顯示器的信號線已和電腦連接 *檢查顯示器信號線插頭並確信各引腳沒有彎曲 *通過按電腦鍵盤上的Caps Lock 鍵觀察指示燈，確認電腦是否在操作。
缺色（紅、綠、藍）	*檢查顯示器的信號線，並確信引腳沒有彎曲

支援及服務資訊

本節的內容，係關於如何取得連線及電話技術支援方面的資訊。

連線技術支援

本公司將於產品使用期間提供連線技術支援，你可經由個人演算支援網站及IBM自動傳真系統獲得連線協助。

連線技術支援	
IBM個人演算支援網站	http://www.ibm.com/pc/support

於保證期間，本公司將提供有關故障元件換新或更換方面的協助。除此之外，若你將另行購買的IBM組件裝設在IBM電腦時，可能也有權利要求在貴處進行產品之服務，本公司的技術支援代表將協助你決定最佳的選擇。

電話技術支援

從取消購買選項起90天內，可依IBM的決定取消經由協助中心（HelpCenter）所提供的安裝及建構支援，或以收費的方式提供。另外也可收取微薄費用的方式，提供額外的支援，其中包括逐步安裝方面之協助。

若無法自行矯正問題時，請聯絡當地的經銷商、零售商或其他經IBM授權的維修中心。你可經由<http://www.ibm.com/pc/support>的IBM支援網頁HelpCenter電話簿上按兩次，而取得支援電話號碼。

撥號以前，請先盡量準備妥下列的資料：

1. 監視器背面上標籤正面的型式、機型及標籤序號
2. 購買收據
3. 問題說明
4. 電腦型式及機型
5. 系統結構（所安裝的硬體等）
6. 基本輸出輸入系統之版別號碼
7. 操作系統及版別號碼
8. 顯示器驅動器之版別號碼

附錄A—規格

顯像管	顯像管尺寸	35.5 cm (14 in.), 平面直角, 29 mm 短管頸
	可視尺寸	對角線長33.5 cm (13.2 in.),
	點距	0.28 mm
輸入信號	視頻信號	類比紅、綠、藍0.7 Vpp
	分離同步	TTL 電平
	水平/垂直同步信號	+/-
掃描頻率	行頻	30 – 54 kHz
	場頻	50 - 120 Hz
最高解析度		1024 x 768
點頻		65 MHz
工廠預置模式:		7
用戶模式:		12
電源		開關電源, 交流100 – 240 V ac, 50 Hz / 60 Hz
環境溫度		0 to 40° C (0 to 104° F)
濕度		相對濕度10% – 85%
尺寸	紙箱	424 mm (1.39 ft) × 424mm (1.39 ft) × 455 mm (1.5 ft) (W × H × D)
	顯示器和底盤	350 mm (1.14 ft) × 349 mm (1.15 ft) × 377 mm (1.2 ft) (W × H × D)
重量	淨重	10.4 kg
	毛重	12.0 kg
信號線		15 針小型D型接頭

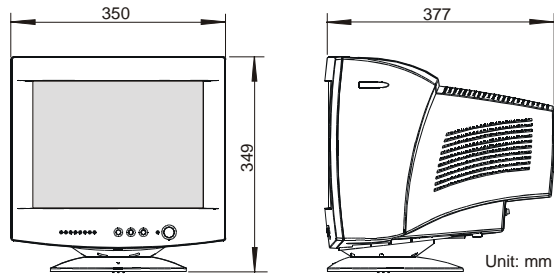

外部控制:	開關	<ul style="list-style-type: none"> ● 電源開關 ● 選擇鍵 ● 功能鍵
	功能	<ul style="list-style-type: none"> ● 對比度 ● 亮度 ● 水平尺寸 ● 水平中心 ● 垂直尺寸 ● 垂直中心 ● 枕形或桶形失真 ● 梯形失真 ● 旋轉
即插即用	DDC1/2B	
節能標準	EPA, VESA DPMS	
功耗	最大75 W	
預設顯示尺寸	250 mm (9.84 in.) x 187mm (7.36 in.)	
安規	UL, FCC, CE, MPR II , FDA, CSA	

附錄B—工廠預置模式表

標準	解析度	行頻	場頻
IBM	720 × 400	31.5 kHz	70 Hz
VGA	640 × 480	31.5 kHz	60 Hz
VESA/75	640 × 480	37.5 kHz	75 Hz
VESA/85	640 × 480	43.3 kHz	85 Hz
VESA/75	800 × 600	46.9 kHz	75 Hz
VESA/85	800 × 600	53.7 kHz	85 Hz
VESA/75	1024 × 768	48.4 kHz	60 Hz

信號線各引腳說明

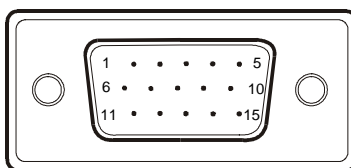

15針彩色顯示信號線

引腳	說明	引腳	說明
1.	紅	9.	空
2.	綠	10.	接地
3.	藍	11.	接地
4.	接地	12.	SDA(串列資料/位址線)
5.	接地	13.	水平同步信號
6.	紅地	14.	垂直同步信號>(*視頻時序)
7.	綠地	15.	SCL(串列時序)
8.	藍地	★	用於 DDC

Warranty Statements

Warranty period – Three (3) years

Your Installation Diskette includes translation of IBM's Statement of Warranty in the following languages:

Worldwide Statement of Warranty (Except Turkiye, U.S., Puerto Rico and Canada):	
Arabic	Z1255697.ara.html
Brazilian portuguese	Z1255697.bra.html
Bulgarian	Z1255697.bul.html
Chinese	Z1255697.chi.html
Croatian	Z1255697.cro.html
Czech	Z1255697.cze.html
Danish	Z1255697.dan.html
Dutch	Z1255697.dut.html
English	Z1255697.eng.html
Finnish	Z1255697.fin.html
French	Z1255697.fre.html
German	Z1255697.ger.html
Greek	Z1255697.gre.html
Hebrew	Z1255697.heb.html
Hungarian	Z1255697.hun.html
Italian	Z1255697.ita.html
Japanese	Z1255697.jap.html
Korean	Z1255697.kor.html
Norwegian	Z1255697.nor.html
Polish	Z1255697.pol.html
Portuguese	Z1255697.por.html
Russian	Z1255697.rus.html
Slovakian	Z1255697.sla.html
Slovenian	Z1255697.sle.html
Spanish	Z1255697.spa.html
Swedish	Z1255697.swe.html
Taiwanese	Z1255697.tai.html

Turkiye Statement of Warranty:	
Turkish	Z1255698.tur.html
English	Z1255698.eng.html

United States, Puerto Rico and Canada Statement of Limited Warranty:	
English	Z1254753.eng.html
French Canadian	Z1254753.fca.html

Warranty Statements

The warranty statements consist of two parts: Part 1 and Part 2. Part 1 varies by country. Part 2 is the same for both statements. Be sure to read both the Part 1 that applies to your country and Part 2.

- **United States, Puerto Rico, and Canada (Z125-4753-05 11/97)**
(Part 1 - General Terms)
- **Worldwide except Canada, Puerto Rico, Turkey, and United States (Z125-5697-01 11/97)**
(Part 1 - General Terms)
- **Worldwide Country-Unique Terms**
(Part 2 - Country-Unique Terms)

IBM Statement of Limited Warranty for United States, Puerto Rico, and Canada (Part 1 - General Terms)

This Statement of Limited Warranty includes Part 1 - General Terms and Part 2 - Country-unique Terms. The terms of Part 2 may replace or modify those of Part 1. The warranties provided by IBM in this Statement of Limited Warranty apply only to Machines you purchase for your use, and not for resale, from IBM or your reseller. The term "Machine" means an IBM machine, its features, conversions, upgrades, elements, or accessories, or any combination of them. The term "Machine" does not include any software programs, whether pre-loaded with the Machine, installed subsequently or otherwise. Unless IBM specifies otherwise, the following warranties apply only in the country where you acquire the Machine. Nothing in this Statement of Warranty affects any statutory rights of consumers that cannot be waived or limited by contract. If you have any questions, contact IBM or your reseller.

Machine - M/T 2248 E40 Color Monitor
Warranty Period* - Three (3) Years

*Contact your place of purchase for warranty service information.
Some IBM Machines are eligible for On-site warranty service depending on the country where service is performed.

The IBM Warranty for Machines

IBM warrants that each Machine 1) is free from defects in materials and workmanship and 2) conforms to IBM's Official Published Specifications. The warranty period for a Machine is a specified, fixed period commencing on its Date of Installation. The date on your sales receipt is the Date of Installation, unless IBM or your reseller informs you otherwise. During the warranty period IBM or your reseller, if approved by IBM to provide warranty service, will provide repair and exchange service for the Machine, without charge, under the type of service designated for the Machine and will manage and install engineering changes that apply to the Machine. If a Machine does not function as warranted during the warranty period, and IBM or your reseller are unable to either 1) make it do so or 2) replace it with one that is at least functionally equivalent, you may return it to your place of purchase and your money will be refunded. The replacement may not be new, but will be in good working order.

Extent of Warranty

The warranty does not cover the repair or exchange of a Machine resulting from misuse, accident, modification, unsuitable physical or operating environment, improper maintenance by you, or failure caused by a product for which IBM is not responsible. The warranty is voided by removal or alteration of Machine or parts identification labels.

THESE WARRANTIES ARE YOUR EXCLUSIVE WARRANTIES AND REPLACE ALL OTHER WARRANTIES OR CONDITIONS, EXPRESS OR IMPLIED, INCLUDING, BUT NOT LIMITED TO, THE IMPLIED WARRANTIES OR CONDITIONS OF MERCHANTABILITY AND FITNESS FOR A PARTICULAR PURPOSE. THESE WARRANTIES GIVE YOU SPECIFIC LEGAL RIGHTS AND YOU MAY ALSO HAVE OTHER RIGHTS WHICH VARY FROM JURISDICTION TO JURISDICTION. SOME JURISDICTIONS DO NOT ALLOW THE EXCLUSION OR LIMITATION OF EXPRESS OR IMPLIED WARRANTIES, SO THE ABOVE EXCLUSION OR LIMITATION MAY NOT APPLY TO YOU. IN THAT EVENT, SUCH WARRANTIES ARE LIMITED IN DURATION TO THE WARRANTY PERIOD. NO WARRANTIES APPLY AFTER THAT PERIOD.

Items Not Covered by Warranty

IBM does not warrant uninterrupted or error-free operation of a Machine. Unless specified otherwise, IBM provides non-IBM machines **WITHOUT WARRANTIES OF ANY KIND.**

Any technical or other support provided for a Machine under warranty, such as assistance via telephone with “how-to” questions and those regarding Machine set-up and installation, will be provided **WITHOUT WARRANTIES OF ANY KIND.**

Warranty Service

To obtain warranty service for the Machine, contact your reseller or IBM. In the United States, call IBM at **1-800-772-2227**. In Canada, call IBM at **1-800-565-3344**. You may be required to present proof of purchase.

IBM or your reseller provides certain types of repair and exchange service, either at your location or at a service center, to keep Machines in, or restore them to, conformance with their Specifications. IBM or your reseller will inform you of the available types of service for a Machine based on its country of installation. IBM may repair the failing Machine or exchange it at its discretion.

When warranty service involves the exchange of a Machine or part, the item IBM or your reseller replaces becomes its property and the replacement becomes yours. You represent that all removed items are genuine and unaltered. The replacement may not be new, but will be in good working order and at least functionally equivalent to the item replaced. The replacement assumes the warranty service status of the replaced item.

Any feature, conversion, or upgrade IBM or your reseller services must be installed on a Machine which is 1) for certain Machines, the designated, serial-numbered Machine and 2) at an engineering-change level compatible with the feature, conversion, or upgrade. Many features, conversions, or upgrades involve the removal of parts and their return to IBM. A part that replaces a removed part will assume the warranty service status of the removed part.

Before IBM or your reseller exchanges a Machine or part, you agree to remove all features, parts, options, alterations, and attachments not under warranty service.

You also agree to

1. ensure that the Machine is free of any legal obligations or restrictions that prevent its exchange;
2. obtain authorization from the owner to have IBM or your reseller service a Machine that you do not own; and
3. where applicable, before service is provided

- a. follow the problem determination, problem analysis, and service request procedures that IBM or your reseller provides, b. secure all programs, data, and funds contained in a Machine,
- b. provide IBM or your reseller with sufficient, free, and safe access to your facilities to permit them to fulfill their obligations, and
- c. inform IBM or your reseller of changes in a Machine's location.

IBM is responsible for loss of, or damage to, your Machine while it is 1) in IBM's possession or 2) in transit in those cases where IBM is responsible for the transportation charges.

Neither IBM nor your reseller is responsible for any of your confidential, proprietary or personal information contained in a Machine which you return to IBM or your reseller for any reason. You should remove all such information from the Machine prior to its return.

Production Status

Each IBM Machine is manufactured from new parts, or new and used parts. In some cases, the Machine may not be new and may have been previously installed. Regardless of the Machine's production status, IBM's appropriate warranty terms apply.

Limitation of Liability

Circumstances may arise where, because of a default on IBM's part or other liability, you are entitled to recover damages from IBM. In each such instance, regardless of the basis on which you are entitled to claim damages from IBM (including fundamental breach, negligence, misrepresentation, or other contract or tort claim), IBM is liable for no more than

1. damages for bodily injury (including death) and damage to real property and tangible personal property; and
2. the amount of any other actual direct damages, up to the greater of U.S. \$100,000 (or equivalent in local currency) or the charges (if recurring, 12 months' charges apply) for the Machine that is the subject of the claim.

This limit also applies to IBM's suppliers and your reseller. It is the maximum for which IBM, its suppliers, and your reseller are collectively responsible.

UNDER NO CIRCUMSTANCES IS IBM LIABLE FOR ANY OF THE FOLLOWING: 1) THIRD-PARTY CLAIMS AGAINST YOU FOR DAMAGES (OTHER THAN THOSE UNDER THE FIRST ITEM LISTED ABOVE); 2) LOSS OF, OR DAMAGE TO, YOUR RECORDS OR DATA; OR 3) SPECIAL, INCIDENTAL, OR INDIRECT DAMAGES OR FOR ANY ECONOMIC CONSEQUENTIAL DAMAGES (INCLUDING LOST PROFITS OR SAVINGS), EVEN IF IBM, ITS SUPPLIERS OR YOUR RESELLER IS INFORMED OF THEIR POSSIBILITY. SOME JURISDICTIONS DO NOT ALLOW THE EXCLUSION OR LIMITATION OF INCIDENTAL OR CONSEQUENTIAL DAMAGES, SO THE ABOVE LIMITATION OR EXCLUSION MAY NOT APPLY TO YOU.

IBM Statement of Warranty Worldwide except Canada, Puerto Rico, Turkey, United States (Part 1 -General Terms)

This Statement of Warranty includes Part 1 - General Terms and Part 2 - Country-unique Terms. **The terms of Part 2 may replace or modify those of Part 1.** The warranties provided by IBM in this Statement of Warranty apply only to Machines you purchase for your use, and not for resale, from IBM or your reseller. The term "Machine" means an IBM machine, its features, conversions, upgrades, elements, or accessories, or any combination of them. The term "Machine" does not include any software programs, whether pre-loaded with the Machine,

installed subsequently or otherwise. Unless IBM specifies otherwise, the following warranties apply only in the country where you acquire the Machine. Nothing in this Statement of Warranty affects any statutory rights of consumers that cannot be waived or limited by contract. If you have any questions, contact IBM or your reseller.

Machine –M/T 2248 E40 Color Monitor
Warranty Period* - Three (3) Years

*Contact your place of purchase for warranty service information. Some IBM Machines are eligible for On-site warranty service depending on the country where service is performed.

The IBM Warranty for Machines

IBM warrants that each Machine 1) is free from defects in materials and workmanship and 2) conforms to IBM's Official Published Specifications. The warranty period for a Machine is a specified, fixed period commencing on its Date of Installation. The date on your sales receipt is the Date of Installation, unless IBM or your reseller informs you otherwise.

During the warranty period IBM or your reseller, if approved by IBM to provide warranty service, will provide repair and exchange service for the Machine, without charge, under the type of service designated for the Machine and will manage and install engineering changes that apply to the Machine. If a Machine does not function as warranted during the warranty period, and IBM or your reseller are unable to either 1) make it do so or 2) replace it with one that is at least functionally equivalent, you may return it to your place of purchase and your money will be refunded. The replacement may not be new, but will be in good working order.

Extent of Warranty

The warranty does not cover the repair or exchange of a Machine resulting from misuse, accident, modification, unsuitable physical or operating environment, improper maintenance by you, or failure caused by a product for which IBM is not responsible. The warranty is voided by removal or alteration of Machine or parts identification labels.

THESE WARRANTIES ARE YOUR EXCLUSIVE WARRANTIES AND REPLACE ALL OTHER WARRANTIES OR CONDITIONS, EXPRESS OR IMPLIED, INCLUDING, BUT NOT LIMITED TO, THE IMPLIED WARRANTIES OR CONDITIONS OF MERCHANTABILITY AND FITNESS FOR A PARTICULAR PURPOSE. THESE WARRANTIES GIVE YOU SPECIFIC LEGAL RIGHTS AND YOU MAY ALSO HAVE OTHER RIGHTS WHICH VARY FROM JURISDICTION TO JURISDICTION. SOME JURISDICTIONS DO NOT ALLOW THE EXCLUSION OR LIMITATION OF EXPRESS OR IMPLIED WARRANTIES, SO THE ABOVE EXCLUSION OR LIMITATION MAY NOT APPLY TO YOU. IN THAT EVENT, SUCH WARRANTIES ARE LIMITED IN DURATION TO THE WARRANTY PERIOD. NO WARRANTIES APPLY AFTER THAT PERIOD.

Items Not Covered by Warranty

IBM does not warrant uninterrupted or error-free operation of a Machine. Unless specified otherwise, IBM provides non-IBM machines **WITHOUT WARRANTIES OF ANY KIND.**

Any technical or other support provided for a Machine under warranty, such as assistance via telephone with "how-to" questions and those regarding Machine set-up and installation, will be provided **WITHOUT WARRANTIES OF ANY KIND.**

Warranty Service

To obtain warranty service for the Machine, contact your reseller or IBM. You may be required to present proof of purchase.

IBM or your reseller provides certain types of repair and exchange service, either at your location or at a service center, to keep Machines in, or restore them to, conformance with their Specifications. IBM or your reseller will inform you of the available types of service for a Machine based on its country of installation. IBM may repair the failing Machine or exchange it at its discretion.

When warranty service involves the exchange of a Machine or part, the item IBM or your reseller replaces becomes its property and the replacement becomes yours. You represent that all removed items are genuine and unaltered. The replacement may not be new, but will be in good working order and at least functionally equivalent to the item replaced. The replacement assumes the warranty service status of the replaced item.

Any feature, conversion, or upgrade IBM or your reseller services must be installed on a Machine which is 1) for certain Machines, the designated, serial-numbered Machine and 2) at an engineering-change level compatible with the feature, conversion, or upgrade. Many features, conversions, or upgrades involve the removal of parts and their return to IBM. A part that replaces a removed part will assume the warranty service status of the removed part.

Before IBM or your reseller exchanges a Machine or part, you agree to remove all features, parts, options, alterations, and attachments not under warranty service.

You also agree to

1. ensure that the Machine is free of any legal obligations or restrictions that prevent its exchange;
2. obtain authorization from the owner to have IBM or your reseller service a Machine that you do not own; and
3. where applicable, before service is provided
 - a. follow the problem determination, problem analysis, and service request procedures that IBM or your reseller provides,
 - b. secure all programs, data, and funds contained in a Machine,
 - c. provide IBM or your reseller with sufficient, free, and safe access to your facilities to permit them to fulfil their obligations, and
 - d. inform IBM or your reseller of changes in a Machine's location.

IBM is responsible for loss of, or damage to, your Machine while it is 1) in IBM's possession or 2) in transit in those cases where IBM is responsible for the transportation charges.

Neither IBM nor your reseller is responsible for any of your confidential, proprietary or personal information contained in a Machine which you return to IBM or your reseller for any reason. You should remove all such information from the Machine prior to its return.

Production Status

Each IBM Machine is manufactured from new parts, or new and used parts. In some cases, the Machine may not be new and may have been previously installed. Regardless of the Machine's production status, IBM's appropriate warranty terms apply.

Limitation of Liability

Circumstances may arise where, because of a default on IBM's part or other liability, you are entitled to recover damages from IBM. In each such instance, regardless of the basis on which you are entitled to claim damages from IBM (including fundamental breach, negligence, misrepresentation, or other contract or tort claim), IBM is liable for no more than

1. damages for bodily injury (including death) and damage to real property and tangible personal property; and
2. the amount of any other actual direct damages, up to the greater of U.S. \$100,000 (or equivalent in local currency) or the charges (if recurring, 12 months' charges apply) for the Machine that is the subject of the claim.

This limit also applies to IBM's suppliers and your reseller. It is the maximum for which IBM, its suppliers, and your reseller are collectively responsible.

UNDER NO CIRCUMSTANCES IS IBM LIABLE FOR ANY OF THE FOLLOWING: 1) THIRD-PARTY CLAIMS AGAINST YOU FOR DAMAGES (OTHER THAN THOSE UNDER THE FIRST ITEM LISTED ABOVE); 2) LOSS OF, OR DAMAGE TO, YOUR RECORDS OR DATA; OR 3) SPECIAL, INCIDENTAL, OR INDIRECT DAMAGES OR FOR ANY ECONOMIC CONSEQUENTIAL DAMAGES (INCLUDING LOST PROFITS OR SAVINGS), EVEN IF IBM, ITS SUPPLIERS OR YOUR RESELLER IS INFORMED OF THEIR POSSIBILITY. SOME JURISDICTIONS DO NOT ALLOW THE EXCLUSION OR LIMITATION OF INCIDENTAL OR CONSEQUENTIAL DAMAGES, SO THE ABOVE LIMITATION OR EXCLUSION MAY NOT APPLY TO YOU.

Part 2 - Worldwide Country-Unique Terms

ASIA PACIFIC

AUSTRALIA: The IBM Warranty for Machines: The following paragraph is added to this Section:

The warranties specified in this Section are in addition to any rights you may have under the Trade Practices Act 1974 or other legislation and are only limited to the extent permitted by the applicable legislation.

Extent of Warranty: The following replaces the first and second sentences of this Section:

The warranty does not cover the repair or exchange of a Machine resulting from misuse, accident, modification, unsuitable physical or operating environment, operation in other than the Specified Operating Environment, improper maintenance by you, or failure caused by a product for which IBM is not responsible.

Limitation of Liability: The following is added to this Section:

Where IBM is in breach of a condition or warranty implied by the Trade Practices Act 1974, IBM's liability is limited to the repair or replacement of the goods or the supply of equivalent goods. Where that condition or warranty relates to right to sell, quiet possession or clear title, or the goods are of a kind ordinarily acquired for personal, domestic or household use or consumption, then none of the limitations in this paragraph apply.

PEOPLE'S REPUBLIC OF CHINA: Governing Law: The following is added to this Statement:

The laws of the State of New York govern this Statement.

INDIA: Limitation of Liability: The following replaces items 1 and 2 of this Section:

1. liability for bodily injury (including death) or damage to real property and tangible personal property will be limited to that caused by IBM's negligence;
2. as to any other actual damage arising in any situation involving nonperformance by IBM pursuant to, or in any way related to the subject of this Statement of Warranty, IBM's liability

will be limited to the charge paid by you for the individual Machine that is the subject of the claim.

NEW ZEALAND: The IBM Warranty for Machines: The following paragraph is added to this Section:

The warranties specified in this Section are in addition to any rights you may have under the Consumer Guarantees Act 1993 or other legislation which cannot be excluded or limited. The Consumer Guarantees Act 1993 will not apply in respect of any goods which IBM provides, if you require the goods for the purposes of a business as defined in that Act.

Limitation of Liability: The following is added to this Section:

Where Machines are not acquired for the purposes of a business as defined in the Consumer Guarantees Act 1993, the limitations in this Section are subject to the limitations in that Act.

EUROPE, MIDDLE EAST, AFRICA (EMEA)

The following terms apply to all EMEA countries.

The terms of this Statement of Warranty apply to Machines purchased from an IBM reseller. If you purchased this Machine from IBM, the terms and conditions of the applicable IBM agreement prevail over this warranty statement.

Warranty Service

If you purchased an IBM Machine in Austria, Belgium, Denmark, Estonia, Finland, France, Germany, Greece, Iceland, Ireland, Italy, Latvia, Lithuania, Luxembourg, Netherlands, Norway, Portugal, Spain, Sweden, Switzerland or United Kingdom, you may obtain warranty service for that Machine in any of those countries from either (1) an IBM reseller approved to perform warranty service or (2) from IBM.

If you purchased an IBM Personal Computer Machine in Albania, Armenia, Belarus, Bosnia and Herzegovina, Bulgaria, Croatia, Czech Republic, Georgia, Hungary, Kazakhstan, Kirghizia, Federal Republic of Yugoslavia, Former Yugoslav Republic of Macedonia (FYROM), Moldova, Poland, Romania, Russia, Slovak Republic, Slovenia, or Ukraine, you may obtain warranty service for that Machine in any of those countries from either (1) an IBM reseller approved to perform warranty service or (2) from IBM.

The applicable laws, Country-unique terms and competent court for this Statement are those of the country in which the warranty service is being provided. However, the laws of Austria govern this Statement if the warranty service is provided in Albania, Armenia, Belarus, Bosnia and Herzegovina, Bulgaria, Croatia, Czech Republic, Federal Republic of Yugoslavia, Georgia, Hungary, Kazakhstan, Kirghizia, Former Yugoslav Republic of Macedonia (FYROM), Moldova, Poland, Romania, Russia, Slovak Republic, Slovenia, and Ukraine.

The following terms apply to the country specified:

EGYPT: Limitation of Liability: The following replaces item 2 in this Section:

2. as to any other actual direct damages, IBM's liability will be limited to the total amount you paid for the Machine that is the subject of the claim. Applicability of suppliers and resellers (unchanged).

FRANCE: Limitation of Liability: The following replaces the second sentence of the first paragraph of this Section:

In such instances, regardless of the basis on which you are entitled to claim damages from IBM, IBM is liable for no more than: (items 1 and 2 unchanged).

GERMANY: The IBM Warranty for Machines: The following replaces the first sentence of the first paragraph of this Section:

The warranty for an IBM Machine covers the functionality of the Machine for its normal use and the Machine's conformity to its Specifications.

The following paragraphs are added to this Section:
The minimum warranty period for Machines is six months.

In case IBM or your reseller are unable to repair an IBM Machine, you can alternatively ask for a partial refund as far as justified by the reduced value of the unrepaired Machine or ask for a cancellation of the respective agreement for such Machine and get your money refunded.

Extent of Warranty: The second paragraph does not apply.

Warranty Service: The following is added to this Section:
During the warranty period, transportation for delivery of the failing Machine to IBM will be at IBM's expense.

Production Status: The following paragraph replaces this Section:
Each Machine is newly manufactured. It may incorporate in addition to new parts, re-used parts as well.

Limitation of Liability: The following is added to this Section:
The limitations and exclusions specified in the Statement of Warranty will not apply to damages caused by IBM with fraud or gross negligence and for express warranty.

In item 2, replace "U.S. \$100,000" with "1.000.000 DEM."

The following sentence is added to the end of the first paragraph of item 2:
IBM's liability under this item is limited to the violation of essential contractual terms in cases of ordinary negligence.

IRELAND: Extent of Warranty: The following is added to this Section:
Except as expressly provided in these terms and conditions, all statutory conditions, including all warranties implied, but without prejudice to the generality of the foregoing all warranties implied by the Sale of Goods Act 1893 or the Sale of Goods and Supply of Services Act 1980 are hereby excluded.

Limitation of Liability: The following replaces items one and two of the first paragraph of this Section:
1. death or personal injury or physical damage to your real property solely caused by IBM's negligence; and 2. the amount of any other actual direct damages, up to the greater of Irish Pounds 75,000 or 125 percent of the charges (if recurring, the 12 months' charges apply) for the Machine that is the subject of the claim or which otherwise gives rise to the claim.

Applicability of suppliers and resellers (unchanged).

The following paragraph is added at the end of this Section:
IBM's entire liability and your sole remedy, whether in contract or in tort, in respect of any default shall be limited to damages.

ITALY: Limitation of Liability: The following replaces the second sentence in the first paragraph:
In each such instance unless otherwise provided by mandatory law, IBM is liable for no more than: (item 1 unchanged) 2) as to any other actual damage arising in all situations involving non-performance by IBM pursuant to, or in any way related to the subject matter of this Statement of Warranty, IBM's liability, will be limited to the total amount you paid for the Machine that is the subject of the claim.

Applicability of suppliers and resellers (unchanged).

The following replaces the second paragraph of this Section:

Unless otherwise provided by mandatory law, IBM and your reseller are not liable for any of the following: (items 1 and 2 unchanged) 3) indirect damages, even if IBM or your reseller is informed of their possibility.

SOUTH AFRICA, NAMIBIA, BOTSWANA, LESOTHO AND SWAZILAND: Limitation of Liability: The following is added to this Section:

IBM's entire liability to you for actual damages arising in all situations involving nonperformance by IBM in respect of the subject matter of this Statement of Warranty will be limited to the charge paid by you for the individual Machine that is the subject of your claim from IBM.

TURKIYE: Production Status: The following replaces this Section:

IBM fulfils customer orders for IBM Machines as newly manufactured in accordance with IBM's production standards.

UNITED KINGDOM: Limitation of Liability: The following replaces items 1 and 2 of the first paragraph of this Section:

1. death or personal injury or physical damage to your real property solely caused by IBM's negligence;
2. the amount of any other actual direct damages or loss, up to the greater of Pounds Sterling 150,000 or 125 percent of the charges (if recurring, the 12 months' charges apply) for the Machine that is the subject of the claim or which otherwise gives rise to the claim.

The following item is added to this paragraph:

3. breach of IBM's obligations implied by Section 12 of the Sale of Goods Act 1979 or Section 2 of the Supply of Goods and Services Act 1982.

Applicability of suppliers and resellers (unchanged).

The following is added to the end of this Section:

IBM's entire liability and your sole remedy, whether in contract or in tort, in respect of any default will be limited to damages.

NORTH AMERICA

CANADA: Warranty Service: The following is added to this Section:

To obtain warranty service from IBM, call **1-800-565-3344**. In Toronto, call **416-383-3344**.

UNITED STATES OF AMERICA: Warranty Service: The following is added to this Section:

To obtain warranty service from IBM, call **1-800-772-2227**.

Compliances

Before operating the monitor please read this manual thoroughly. This manual should be retained for future reference.

FCC Class B Radio Frequency Interference Statement **WARNING: (FOR FCC CERTIFIED MODELS)**

NOTE: This equipment has been tested and found to comply with the limits for a Class B digital device, pursuant to Part 15 of the FCC Rules. These limits are designed to provide reasonable protection against harmful interference in a residential installation. This equipment generates, uses and can radiate radio frequency energy, and if not installed and used in accordance with the instructions, may cause harmful interference to radio communications. However, there is no guarantee that interference will not occur in a particular installation. If this equipment does cause harmful interference to radio or television reception, which can be determined by turning the equipment off and on, the user is encouraged to try to correct the interference by one or more of the following measures:

1. Reorient or relocate the receiving antenna.
2. Increase the separation between the equipment and receiver.
3. Connect the equipment into an outlet on a circuit different from that to which the receiver is connected.
4. Consult the dealer or an experienced radio/TV technician for help.

Notice :

1. The changes or modifications not expressly approved by the party responsible for compliance could void the user's authority to operate the equipment.
2. Shielded interface cables and AC power cord, if any, must be used in order to comply with the emission limits.
3. The manufacturer is not responsible for any radio or TV interference caused by unauthorized modification to this equipment. It is the responsibilities of the user to correct such interference.

Power Cords

For your safety, IBM provides a power cord with a grounded attachment plug to use with this IBM product. To avoid electrical shock, always use the power cord and plug with a properly grounded power outlet.

IBM power cords used in the United States and Canada are listed by the Underwriter's Laboratories (UL) and certified by the Canadian Standards Association (CSA).

For units intended to be operated at 115 volts: Use a UL-listed and CSA-certified cord set consisting of a minimum 18 AWG, Type SVT or SJT, three-conductor cord, a maximum of 15 feet in length and a parallel blade, grounding-type attachment plug rated 15 amperes, 125 volts.

For units intended to be operated at 230 volts (U.S. use): Use a UL-listed and CSA-certified cord set consisting of a minimum 18 AWG, type SVT or SJT, three-conductor cord, a maximum of 15 feet in length and a tandem blade, grounding-type attachment plug rated 15 amperes, 250 volts.

For units intended to be operated at 230 volts (outside the U.S.): Use a cord set with a grounding-type attachment plug. The cord set should have the appropriate safety approvals for the country in which the equipment will be installed.

IBM power cords for a specific country or region are usually available only in that country or region.

IBM fig. # (plug stnd.)	IBM part number	Using countries
4 (NEMA 5-15P) 125 V	6952301	US, Canada, Mexico, Brazil, Costa Rica, Peru, Colombia, Ecuador, Venezuela, Bolivia, Panama, El Salvador, Honduras, Nicaragua, Dominican Republic, Guatemala, Taiwan, Saudi Arabia, Thailand, Philippines, Japan
6 (AS/NZS c112)	13F9939	Austria, New Zealand
18 (CEE 7 – vii)	13F9978	France, Germany, Sweden, Norway, Austria, Netherlands, Finland, Belgium, Bosnia, Croatia, Egypt, Greece, Hungary, Poland, Portugal, Romania, Slovenia, Spain, Sweden, Turkey, Iceland, Estonia, Latvia, Lithuania, Luxembourg, Andorra, Guadeloupe, French Guyana, Martinique, Monaco, New Caledonia, Madagascar, Mauritius, Greece, Turkey, Portugal, Albania, Armenia, Azerbaijan, Belarus, Bosnia, Croatia, Czech Republic, Georgia, Hungary, Kazakhstan, Kyrgyzstan, Macedonia,

		Moldavia, Poland, Romania, Serbia, Slovakia, Slovenia, Tajikistan, Turkmenistan, Ukraine, Uzbekistan, Russia, Lebanon, Syria, Egypt, Iran, Algeria, Benin, Cape Verde, Burkina Faso, Cameroon, Central African Republic, Chad, Congo (Republic of), Congo (Democratic Republic of), Djibouti, Equatorial Guinea, Gabon, Guinea, Guinea Bissau, Ivory Coast, Mali, Mauritania, Morocco, Niger, Senegal, Togo, Tunisia, Angola, Burundi, Ethiopia, Mozambique, Rwanda, Somalia, Sao Tome, Eritrea, Mayotte, Comoros, Reunion, French Polynesia, Vanuatu, Wallis and Futuna, Korea, Vietnam, Indonesia
23 (BS 1363/A)	14F0032	UK, United Arab Emirate (Dubai) Hong Kong, Singapore, Malaysia, Ireland, Cyprus, Bahrain, Jordan, Kuwait, Oman, Qatar, Yemen, Gambia, Malta, Botswana, Seychelles, Nigeria, Ghana, Kenya, Liberia, Malawi, Sierra Leone, Sudan, Tanzania, Zambia, Zimbabwe
19 (DK2-5a)	13F9996	Denmark
25 (CEI 23-16)	14F0068	Italy, Chile
2 (IRSM 2073)	36L8879	Argentina, Uruguay, Paraguay
62 (GB 2099.1)	02K0545	China
32 (SI 32)	14F0086	Israel
22 (SABS 164)	14F0014	South Africa, India, Sri Lanka, Pakistan, Uganda, Lesotho, Namibia, Swaziland
24 (1011-S24507)	14F0050	Switzerland, Lichtenstein

Industry Canada Class B emission compliance statement

This Class B digital apparatus complies with Canadian ICES-003.

Cet appareil numérique de la classe B respecte toutes les exigences du Règlement sur le matériel brouilleur du Canada.

Avis de conformité à la réglementation d'Industrie Canada

Cet appareil numérique de classe B est conforme à la norme NMB-003 du Canada.

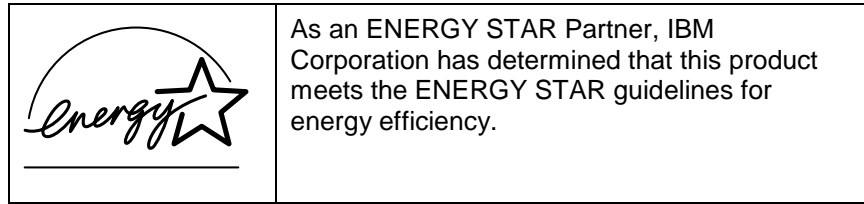

MPRII

This product complies with Swedish National Council for Metrology (MPR) standards issued in December 1999 (MPRII) for very low frequency (VLF) and Extremely low frequency (ELF) emissions.

Hinweise

Gemäß der Amtsblätter des BMPT Nm. 61Ú1991 und 6Ú1992 wird der Betreiber darauf aufmerksam gemacht, daß die von ihm mit diesem Gerät zusammengestellte Anlage auch den technischen Bestimmungen dieser Amtsblätter genügen muß.

Aus ergonomischen Gründen wird empfohlen, die Grundfarbe Blau nicht auf dunklem Untergrund zu verwenden (schlechte Erkennbarkeit, Augenbelastung bei zu geringem Zeichenkontrast).

Aus ergonomischen Gründen sollten nur Darstellungen auf dunklem Hintergrund bei Vertikalfrequenzen ab 60 Hz (ohne Zeilensprung) benutzt werden.

Die Konvergenz des Bildes kann sich auf Grund des Magnetfeldes am Ort der Aufstellung aus der Korrekten Grundeinstellung verändern. Zur Korrektur empfiehlt es sich deshalb, die Regler an der Frontseite für H STAT und V STAT so einzustellen, daß die getrennt sichtbaren Farblinien für Rot, Grün und Blau bei z.B. der Darstellung eines Buchstabens zur Deckung (Konvergenz) gelangen. Siehe hierzu auch die Erklärungen zu H STAT und V STAT.

European Union (EU) Statement

This product is in conformity with the protection requirements of the EU Council Directive 89/366/ECC on the approximation of the laws of the Member States relating to electromagnetic compatibility

IBM can not accept responsibility for any failure to satisfy the protection requirements resulting from a non-recommended modification of the product, including the fitting of non-IBM option cards.

This product has been tested and found to comply with the limits for Class B Information Technology Equipment according to CISPR 22 Ú European Standard EN 55022. The limits for Class B equipment were derived for typical residential environments to provide reasonable protection against interference with licensed communication devices.

Properly shielded and grounded cables and connectors must be used in order to reduce the potential for causing interference to radio and TV communications and to other electrical or electronic equipment. Such cables and connectors are available from IBM authorised dealers.

In accordance with EN 50082-1 1992, Performance Criterion A:, it should be noted that in the presence of certain electromagnetic fields, some screen jitter may be observed.

Spécifications de la CEE

Ce produit est conforme aux exigences de protection de la directive 89/ 336/ EEC du Conseil de l'UE sur le rapprochement des lois des États membres en matière de compatibilité électromagnétique.

IBM ne peut accepter aucune responsabilité pour le manquement aux exigences de protection résultant d'une modification non recommandée du produit, y compris l'installation de cartes autres que les cartes IBM.

Ce produit a été testé et il satisfait les conditions de l'équipement informatique de Classe B en vertu de CISPR22 / Standard européen EN 55022. Les conditions pour l'équipement de Classe B ont été définies en fonction d'un contexte résidentiel ordinaire afin de fournir

une protection raisonnable contre l'interférence d'appareils de communication autorisés.

Des câbles blindés et correctement reliés à la terre doivent être utilisés pour réduire les risques d'interférence avec des communications radio et télévisées, ainsi qu'avec des équipements électriques ou électroniques. Ces câbles et connecteurs sont disponibles auprès de vos revendeurs IBM agréés.

Conformément à la norme EN 50082- 1 1992 (Critère de Performance A), l'utilisateur doit être conscient du fait qu'en présence de certains champs électromagnétiques, l'image peut être instable.

Erklärung für die Europäische Union (EU)

Dieses Produkt wurde getestet, und dabei wurde festgestellt, daß es gemäß CISPR-2 Ú Europäische Norm EN 55022 die Grenzwerte für Ausrüstung der Informationstechnik, Klasse B, einhält. Die Grenzwerte für Ausrüstung der Klasse B wurden für eine typische Wohnumgebung erarbeitet, um einen angemessenen Schutz vor Störungen im Zusammenhang mit zugelassenen Kommunikationsgeräten zu gewährleisten.

Es sind ordnungsgemäß abgeschirmte und geerdete Kabel und Stecker zu verwenden, um das Störungspotential in bezug auf Radio- und Fernsehempfang oder andere elektrische oder elektronische Geräte zu reduzieren. Solche Kabel und Stecker sind bei autorisierten IBM- Fachhändlern erhältlich.

In Übereinstimmung mit EN 50082-1 1992, Leistungskriterium A wird darauf hingewiesen, daß bestimmte elektromagnetische Felder ein Flattern auf dem Bildschirm hervorrufen können.

Declaración de la Unión Europea (UE)

Este producto satisface los requisitos de protección del Consejo de la UE, Directiva 89/ 336/ CEE en lo que a la legislación de los Estados Miembros sobre compatibilidad electromagnética se refiere.

IBM no puede aceptar responsabilidad alguna si este producto deja de satisfacer dichos requisitos de protección como resultado de una modificación no recomendada del producto, incluyendo el ajuste de tarjetas de opción que no sean IBM.

Este producto ha sido probado y satisface los límites para Equipos Informáticos Clase B de conformidad con el Estándar CISPR22 y el Estándar Europeo EN 55022. Los límites para los equipos de Clase B se han establecido para entornos residenciales típicos a fin de proporcionar una protección razonable contra las interferencias con dispositivos de comunicación licenciados.

Se deben utilizar conectores y cables debidamente protegidos y conectados a tierra a fin de reducir las posibilidades de que se produzcan interferencias con comunicaciones por radio o televisión y otros equipos eléctricos o electrónicos. Este tipo de cables y conectores pueden adquirirse en concesionarios autorizados de IBM.

De acuerdo con la norma EN 50082- 1 1992, Performance Criterion A, habría que destacar que en presencia de determinados campos electromagnéticos, podría observarse una marcada inestabilidad e la imagen.

Dichiarazione di conformità dell'Unione Europea (EU)

Questo prodotto è conforme alle normative di protezione ai sensi della Direttiva del Consiglio dell'Unione Europea 89/ 336/ CEE sull'armonizzazione legislativa degli stati membri in materia di compatibilità elettromagnetica.

IBM non accetta responsabilità alcuna per la mancata conformità alle normative di protezione dovuta a modifiche non consigliate al prodotto, compresa l'installazione di schede e componenti di marca diversa da IBM.

Le prove effettuate sul presente prodotto hanno accertato che esso rientra nei limiti stabiliti per le apparecchiature di informatica Classe B ai sensi del CISPR 22 / Norma Europea EN 55022. I limiti delle apparecchiature della Classe B sono stati stabiliti al fine di fornire ragionevole protezione da interferenze mediante dispositivi di comunicazione in concessione in ambienti residenziali tipici.

Utilizzare cavi e connettori collegati a terra per ridurre il rischio potenziale di interferenza delle comunicazioni radiotelevisive e di altri apparecchi elettrici o elettronici. I cavi sono disponibili presso i rivenditori IBM.

In accordo con quanto previsto nel documento EN 50082- 1 1992, Performance Criterion A, è importante sottolineare che in presenza di determinati campi elettromagnetici è possibile che si verifichi un certo tremolio delle immagini.

Europeiska unionen (EU)

Denna produkt har testats och följer gränsvärdena för Klass B Information Technology Equipment enligt CISPR 22 och Europeisk standard EN 55022. Gränsvärden för Klass B-utrustning utgår från vanliga bostadsområden för att ge ett rimligt skydd mot störningar i kommunikationsenheter.

Korrekt avskärmade och jordade kablar och kontakter måste användas för att minska risken för störningar i radio- och TV-kommunikationer och annan elektrisk utrustning. Sådana kablar och kontakter finns tillgängliga hos auktoriserade IBM-återförsäljare.

I enlighet med EN 50082-1 1992, Performance Criterion A påpekas följande: I närheten av en del elektromagnetiska fält kan vissa bildstörningar uppstå på skärmen.

**Deutsche EMV-Direktive
(electromagnetische Verträglichkeit)**

Dieses Gerät ist berechtigt in Übereinstimmung mit dem deutschen EMVG vom 9.Nov.92 das EG-Konformitätszeichen zu führen.

Der Aussteller der Konformitätserklärung ist die IBM UK, Greenock.

Dieses Gerät erfüllt die Bedingungen der EN 55022 Klasse B.

Korean B급 규격 증명서

이 장치는 옥내용으로 보증되었으며 모든 환경에서 사용할 수 있습니다.

Service Information

The following parts are for use by IBM service, or IBM authorized dealers, to support customer warranty. Parts are for service use only.

Model Type 2248

Part Number	M/T-Model	Description
22P4585	2248-0CN	Monitor-UVNH (pearl white)
06P3799	2248-0CE	Monitor-UVEQ (pearl white)
22P4778	2248-0CN 2248-0CE	Tilt/Swivel Base (pearl white)

Free Manuals Download Website

<http://myh66.com>

<http://usermanuals.us>

<http://www.somanuals.com>

<http://www.4manuals.cc>

<http://www.manual-lib.com>

<http://www.404manual.com>

<http://www.luxmanual.com>

<http://aubethermostatmanual.com>

Golf course search by state

<http://golfingnear.com>

Email search by domain

<http://emailbydomain.com>

Auto manuals search

<http://auto.somanuals.com>

TV manuals search

<http://tv.somanuals.com>