

lenovo

Lenovo IdeaPad U310/U410

User Guide v1.0



Read the safety notices and important tips in the included manuals before using your computer.

ideapad

Note

- Before using the product, be sure to read *Lenovo Safety and General Information Guide* first.
- Some instructions in this guide may assume that you are using Windows® 7. If you are using other Windows operating system, some operations may be slightly different. If you are using other operating systems, some operations may not apply to you.
- The features described in this guide are common to most models. Some features may not be available on your computer and/or your computer may include features that are not described in this user guide.
- The illustrations used in this manual are for Lenovo IdeaPad U410 unless otherwise stated.
- The illustrations in this manual may differ from the actual product. Please refer to the actual product.

Regulatory Notice

- To refer to it, go to <http://consumersupport.lenovo.com/> and click **User guides and manuals**.

First Edition (January 2012)

© Copyright Lenovo 2012.

LIMITED AND RESTRICTED RIGHTS NOTICE: If data or software is delivered pursuant a General Services Administration "GSA" contract, use, reproduction, or disclosure is subject to restrictions set forth in Contract No. GS-35F-05925.

Contents

Chapter 1. Getting to know your computer	1
Top view	1
Left-side view	4
Right-side view	6
Front view	8
Bottom view	9
Chapter 2. Learning the basics.....	11
First use.....	11
Using AC adapter and battery	13
Using the touchpad.....	14
Using the keyboard.....	15
Connecting external devices.....	18
Special keys and buttons.....	21
System status indicators.....	22
Securing your computer.....	24
Chapter 3. Connecting to the Internet.....	25
Wired connection	25
Wireless connection	27
Chapter 4. OneKey Rescue system.....	28
OneKey Rescue system	28
Chapter 5. Troubleshooting	31
Frequently asked questions	31
Troubleshooting	33
Trademarks.....	38

Chapter 1. Getting to know your computer

■ ■ Top view

■ U310

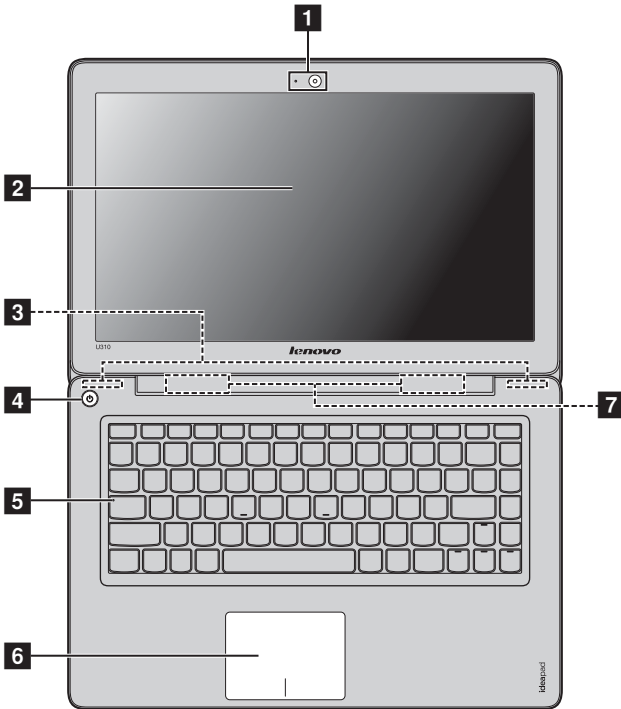

Chapter 1. Getting to know your computer

■ U410

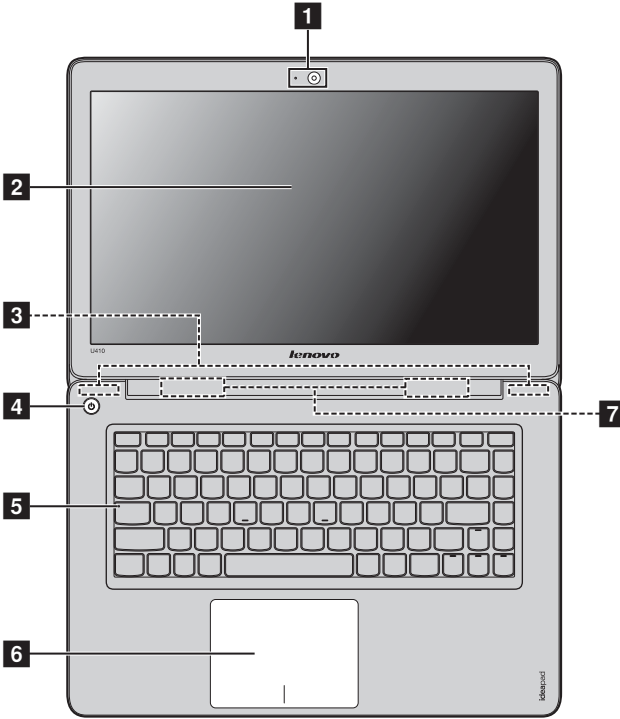

Note: The illustrations in this manual may differ from the actual product. Please refer to the actual product.

⦿ Attention:

- Do NOT open the display panel beyond 130 degrees. When closing the display panel, be careful NOT to leave pens or any other objects in between the display panel and the keyboard. Otherwise, the display panel may be damaged.
- The parts bounded by dashed lines are internally installed.

Chapter 1. Getting to know your computer

- 1 Integrated camera** Use the camera for video communication.
 - 2 Computer display** The LCD display with LED backlight provides brilliant visual output.
 - 3 Wireless module antennas** The built-in antennas ensure optimal reception of wireless radio.
 - 4 Power button** Press this button to turn on the computer.
 - 5 System status indicators** For details, see “System status indicators” on page 22.
 - 6 Touchpad** The touchpad functions as a conventional mouse.
- Note:** For details, see “Using the touchpad” on page 14.
- 7 Speakers** The stereo speakers provide rich and powerful sound.

Chapter 1. Getting to know your computer

■ ■ Left-side view

■ U310

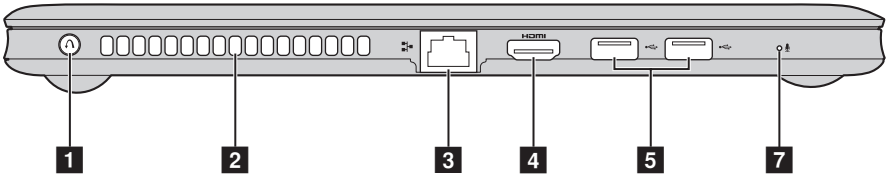

■ U410

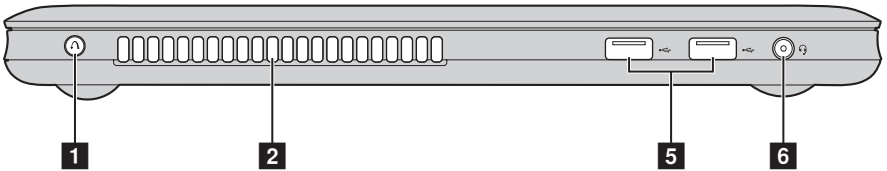

- 1 OneKey Rescue system button** Press this button to start the OneKey Rescue system when the computer is powered off.

Note: For details, see “OneKey Rescue system” on page 28.

- 2 Fan louvers** Dissipate internal heat.

Note: Make sure that none of the fan louvers are blocked or else overheating of the computer may occur.

- 3 RJ-45 port** This port connects the computer to an Ethernet network.

Note: For details, see “Wired connection” on page 25.

- 4 HDMI port** Connects to devices with HDMI input such as a TV or a display.

- 5 USB port** Connect to USB devices.

Note: For details, see “Connecting USB devices” on page 19.

Chapter 1. Getting to know your computer

- 6 Combo audio jack** Connects to headphones or headsets. The combo audio jack does not support conventional microphones.

Note: Recording may not be supported if third-party headphones or headsets are connected, due to different industry standards.

- 7 Built-in microphone** The built-in microphone (with noise reduction) can be used for video conferencing, voice narration, or simple audio recordings.

Chapter 1. Getting to know your computer

Right-side view

U310

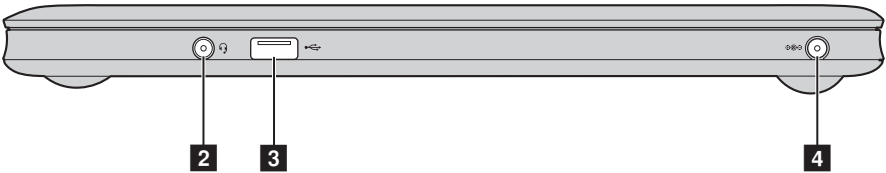

U410

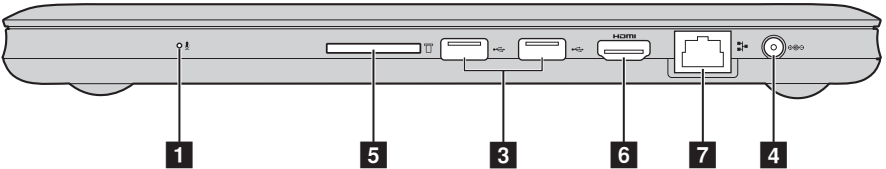

1 Built-in microphone

The built-in microphone (with noise reduction) can be used for video conferencing, voice narration, or simple audio recordings.

2 Combo audio jack

Connects to headphones or headsets. The combo audio jack does not support conventional microphones.

Note: Recording may not be supported if third-party headphones or headsets are connected, due to different industry standards.

3 USB port

Connects to USB devices.

Note: For details, see “Connecting USB devices” on page 19.

4 AC power adapter jack

Connect the AC adapter here.

Note: For details, see “Using AC adapter and battery” on page 13.

5 Memory card slot

Insert memory cards (not supplied) here.

Note: For details, see “Using memory cards (not supplied)” on page 18.

Chapter 1. Getting to know your computer

- 6 HDMI port** Connects to devices with HDMI input such as a TV or a display.
- 7 RJ-45 port** This port connects the computer to an Ethernet network.

Note: For details, see “Wired connection” on page 25.

Chapter 1. Getting to know your computer

■ ■ Front view

■ U310

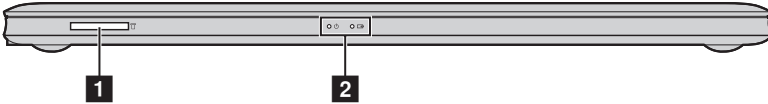

■ U410

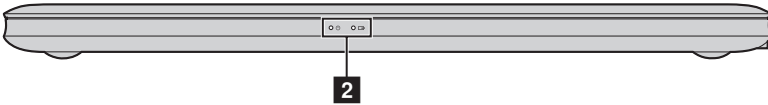

- 1 Memory card slot** Insert memory cards (not supplied) here.

Note: For details, see “Using memory cards (not supplied)” on page 18.

- 2 System status indicators** For details, see “System status indicators” on page 22.

■ ■ **Bottom view**

■ **U310**

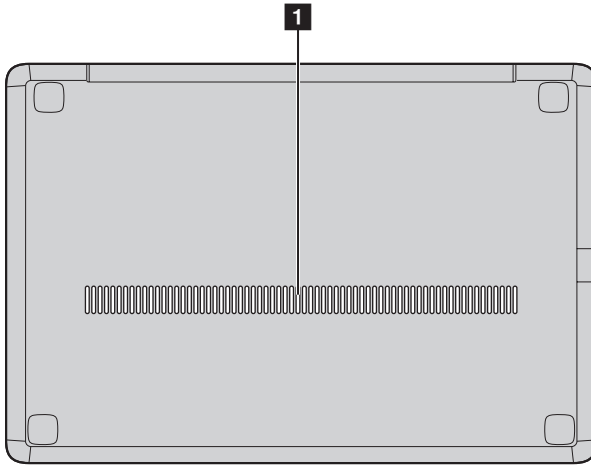

Chapter 1. Getting to know your computer

■ U410

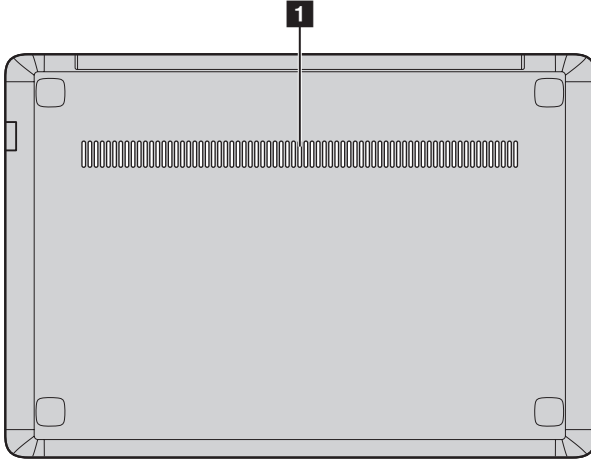

1 Louvers

Allow air to enter the computer for cooling.

Chapter 2. Learning the basics

■ ■ First use

■ Reading the manuals

Read the supplied manuals before using your computer.

■ Connecting to the power

The built-in battery pack is not fully charged at purchase.

To charge the battery and begin using your computer, connect the computer to an electrical outlet. The battery is automatically charged while the computer is running on AC power.

Connecting the computer to an electrical outlet

- ① Connect the power cord to the AC adapter.
- ② Connect the AC adapter to the AC power adapter jack of the computer firmly.
- ③ Plug the power cord into an electrical outlet.

■ Turning on the computer

Press the power button to turn on the computer.

■ Configuring the operating system

You may need to configure the operating system when it is first used. The configuration process may include the procedures below.

- Accepting the end user license agreement
- Configuring the Internet connection
- Registering the operating system
- Creating a user account

Chapter 2. Learning the basics

■ Putting your computer into sleep state or shutting it down

When you finish working with your computer, you can put it into sleep state or shut it down.

Putting your computer into sleep state

If you will be away from your computer for only a short time, put the computer into sleep state.

When the computer is in sleep state, you can quickly wake it to resume use, and bypass the startup process.

To put the computer into sleep state, click  and select **Sleep** from the Start menu.

Note: Wait until the power indicator light starts blinking (indicating that the computer is in sleep state) before you move your computer. Moving your computer while the hard disk is spinning can damage the hard disk, causing loss of data.

To wake the computer, do one of the following.

- Press the power button.
- Press any key on the keyboard.

■ Shutting down your computer

If you are not going to use your computer for a day or two, shut it down.

To shut down your computer, click  and select **Shut down** from the Start menu.

■ ■ Using AC adapter and battery

■ Checking battery status

You can determine the percentage of battery power remaining by checking the battery icon in the notification area.

Note: As each computer user has different habits and needs, it is difficult to predict how long a battery charge will last. There are two main factors:

- The amount of energy stored in the battery when you commence work.
- The way you use your computer: for example, how often you access the hard disk drive and how bright you make the computer display.

■ Charging the battery

If the battery power is low, you need to charge the battery.

You need to charge the battery in any of the following situations:

- If the battery status indicator starts blinking
- If the battery has not been used for a long time

Note:

- To increase the life of the battery pack, the computer does not start recharging the battery immediately after it drops from fully charged.
- Charge the battery at a temperature between 50 °F and 86 °F (10 °C-30 °C).
- Full charge or discharge is not required.

■ Battery Protection

If the battery pack remains idle for a long time, the battery may be over-discharged, and its degradation speed may be increased. The battery pack of IdeaPad U series uses the battery protection technology. When your computer remains idle for a long time, the battery pack enters the sleep mode to avoid over-discharge. After the battery pack enters the sleep mode, you cannot turn the computer on without using the power adapter. Please connect the power adapter to the computer to activate the battery pack.

Note: The batter pack is in the sleep mode by default. When you use the computer for the first time, please plug the power adapter into it. Otherwise, the computer cannot be turned on.

■ ■ Using the touchpad

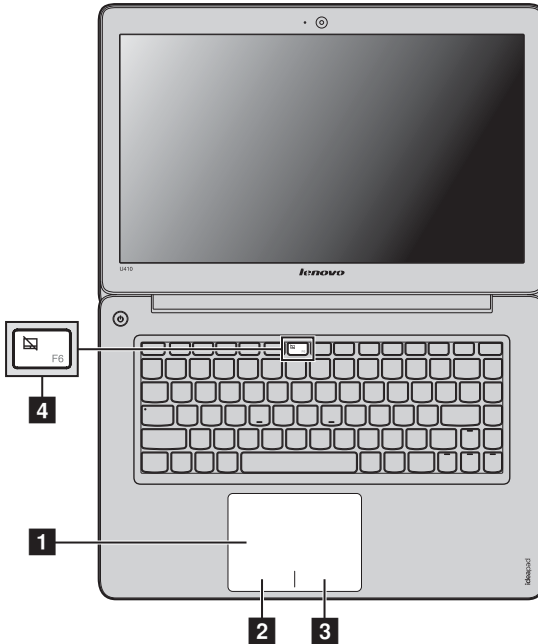

1 Touchpad

To move the cursor on the screen, slide your fingertip over the pad in the direction in which you want the cursor to move.

2 Left-click area

The function corresponds to that of the left mouse button on a conventional mouse, which can be implemented by clicking this area.

3 Right-click area

The function corresponds to that of the right mouse button on a conventional mouse, which can be implemented by clicking this area.

Note: You can enable/disable the touchpad by pressing **4**.

■ ■ Using the keyboard

Your computer has function keys incorporated in its standard keyboard.

■ Function key combinations

By pressing the appropriate function keys, you can change system settings instantly. To use this function, press and hold **Fn 1**, then press one of the function keys **2**.

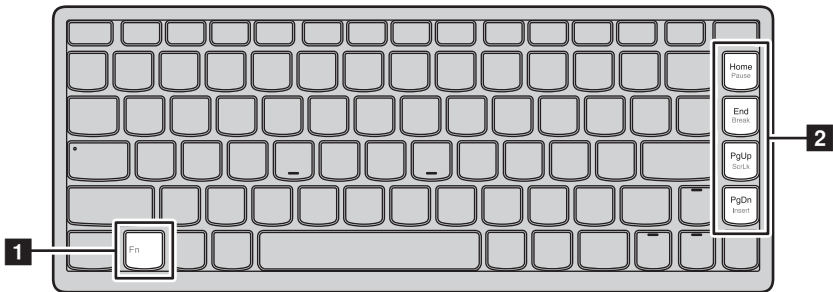

The following describes the features of each function key.

Fn + Home:	Activate the pause function.
Fn + End:	Activate the break function.
Fn + PgUp:	Enable/Disable the scroll lock.
Fn + PgDn:	Activate the insert function.

Chapter 2. Learning the basics

■ Hotkeys

Using hotkeys

The hotkeys are located in the function key row of the keyboard.

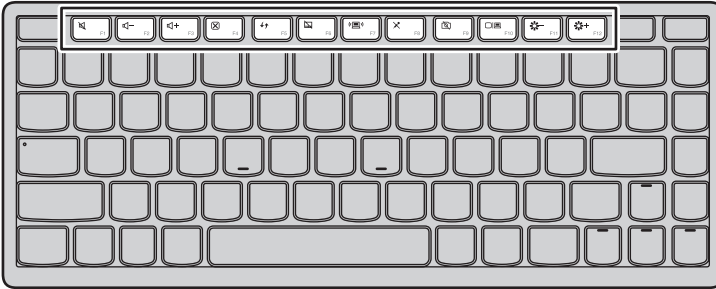

By pressing the appropriate hotkey, you can change system settings instantly. The following describes the function of each hotkey.



F1: Mute/Unmute.



F2: Decrease sound volume.



F3: Increase sound volume.



F4: Close active window or program.



F5: Refresh desktop or Web pages.



F6: Enable/Disable the touchpad.



F7: Open the interface for integrated wireless devices settings (on/off).



F8: Enable/Disable the built-in microphone.



F9: Turn on/off the integrated camera.



F10: Open the interface for changing display devices.



F11: Decrease display brightness.



F12: Increase display brightness.

Setting hotkey mode

By default, the hotkey functions are accessible by pressing the appropriate hotkey. However, you can disable the hotkey mode in the BIOS setup utility. To disable the hotkey mode:

- ➊ Restart the computer. When the Lenovo logo appears, immediately press **Fn + F2** to enter the BIOS setup utility.
- ➋ In the BIOS setup utility, open the **Configuration** menu, and change the setting of **HotKey Switch** from **Hotkey Mode** to **Legacy Mode**.
- ➌ Open the **Exit** menu, and select **Exit Saving Changes**.

Note: When hotkey mode is disabled, press the **Fn** key and the appropriate hotkey to access the corresponding hotkey function.

Chapter 2. Learning the basics

■ ■ Connecting external devices

Your computer has a wide range of built-in features and connection capabilities.

■ Using memory cards (not supplied)

Your computer supports the following types of memory cards:

- Secure Digital (SD) card
- MultiMediaCard (MMC)

Note:

- Insert ONLY one card in the slot at a time.
- This card reader does not support SDIO devices (e.g., SDIO Bluetooth, etc.).

Inserting a memory card

- ➊ Push the dummy card until you hear a click. Gently pull the dummy card out of the memory card slot.

Note: The dummy card is used for preventing dust and small particles from entering the inside of your computer when the memory card slot is not in use. Retain the dummy card for future use.

- ➋ Slide the memory card in until it clicks into place.

Removing a memory card

- ➊ Push the memory card until you hear a click.
- ➋ Gently pull the memory card out of the memory card slot.

Note: Before removing the memory card, disable it via Windows safely remove hardware and eject media utility to avoid data corruption.

■ Connecting USB devices

You can connect a USB device to your computer by inserting its USB plug (Type A) into the USB port on your computer.

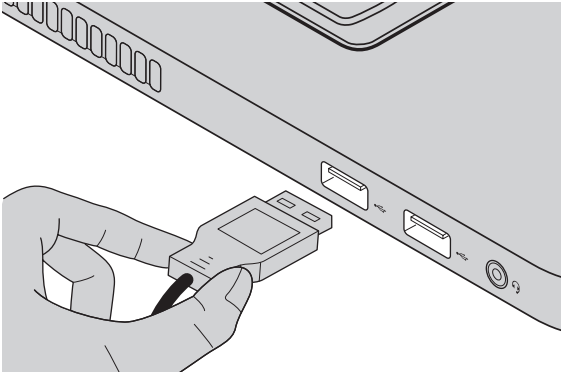

The first time you plug a USB device into a particular USB port on your computer, Windows automatically installs a driver for that device. After the driver is installed, you can disconnect and reconnect the device without performing any additional steps.

Note: Typically, Windows detects a new device after connecting it, and then installs the driver automatically. However, some devices may require you to install the driver before connecting. Check the documentation provided by the device's manufacturer before connecting the device.

Before disconnecting a USB storage device, make sure your computer has finished transferring data by that device. Click the **Safely Remove Hardware** icon in the notification area of Windows to remove the device before disconnecting.

Note: If your USB device uses a power cord, connect the device to a power source before connecting it. Otherwise, the device may not be recognized.

Chapter 2. Learning the basics

■ Connecting *Bluetooth* enabled device (on select models)

If your computer has an integrated *Bluetooth* adapter card, it can connect to and transfer data wirelessly to other *Bluetooth* enabled devices, such as notebook computers, PDAs and cell phones. You can transfer data between these devices without cables and up to 10 meters range in open space.

Note: The actual maximum range may vary due to interference and transmission barriers. To get the best possible connection speed, place the device as near your computer as possible.

Enabling *Bluetooth* communications on your computer

Press  to make configuration.

Note:

- When you do not need to use the *Bluetooth* function, turn it off to save battery power.
- You need to pair the *Bluetooth* enabled device with your computer before you can transfer data between them. Read the documentation supplied with the *Bluetooth* enabled device for details on how to pair the device with your computer.

■ ■ Special keys and buttons

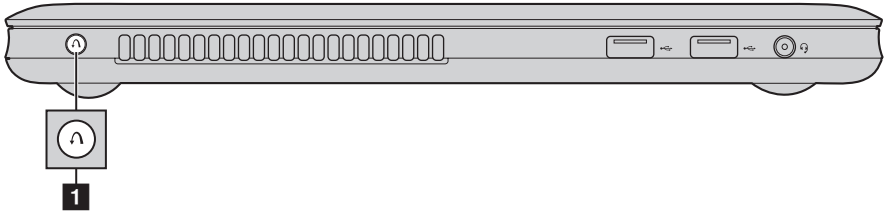

■ OneKey Rescue system button **1**

- When the computer is powered off, press this button to start the OneKey Rescue system.
- In the Windows operating system, press this button to start the Lenovo OneKey Recovery system.

Note: For details, see “OneKey Rescue system” on page 28.

Chapter 2. Learning the basics

■ ■ System status indicators

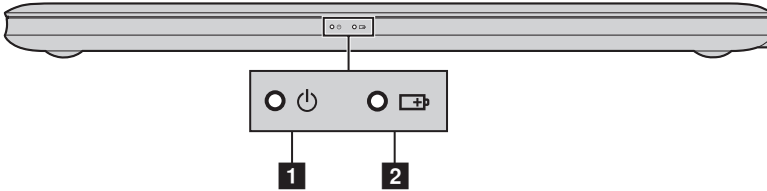

These indicators inform you of the computer status.



1 Power status indicator 

2 Battery status indicator 

Chapter 2. Learning the basics

No.	Symbol	Indicator	Indicator status	Meaning
1		Power	On (solid white)	The computer is powered on.
			Blinking	The computer is in sleep mode.
			Off	The computer is powered off.
2		Battery	On (solid white)	The battery has more than 20% charge.
			Solid amber	The battery has between 5% and 20% charge.
			Fast blinking amber	The battery has less than 5% charge.
			Slow blinking amber	The battery is being charged. When battery charge reaches 20%, the blinking color changes to white.
			Slow blinking white	The battery has between 20% and 80% charge and is still charging. When the battery reaches 80% charge the light will stop blinking, but charging will continue until the battery is fully charged.
			Off	The battery is detached.

Chapter 2. Learning the basics

■ ■ Securing your computer

This section provides information about how to help protect your computer from theft and unauthorized use.

■ Using passwords

Using passwords helps prevent your computer from being used by others. Once you set a password and enable it, a prompt appears on the screen each time you power on the computer. Enter your password at the prompt. The computer cannot be used unless you enter the correct password.

Note: This password can be from one to seven alphanumeric characters in any combination.

For details about how to set the password, see the Help to the right of the screen in BIOS setup utility.

Note: To enter BIOS setup utility, press **Fn + F2** (when **HotKey Switch** is set to **Hotkey Mode**) or **F2** (when **HotKey Switch** is set to **Legacy Mode**) when the Lenovo logo appears on the screen while the computer is starting up.

Chapter 3. Connecting to the Internet

As a global network, the Internet connects computers worldwide, providing services such as e-mailing, information searching, electronic commerce, Web browsing and entertainment.

You can connect the computer to the Internet in the following way:

Wired connection: use physical wiring to connect.

Wireless network technology: connect without wiring.

■ ■ Wired connection

Wired connections are a reliable and safe way to connect the computer to the Internet.

Cable	Cable Internet services use a cable modem connected to the residential cable TV line.
DSL	DSL is a family of related technologies that bring high-speed network access to homes and small businesses over ordinary telephone lines.

■ Hardware connection

Cable

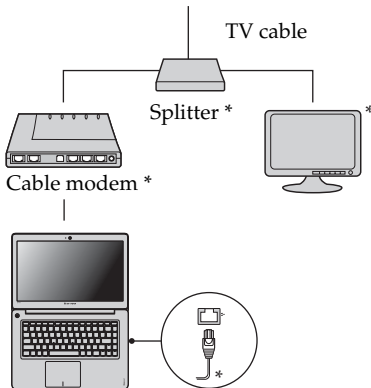

DSL

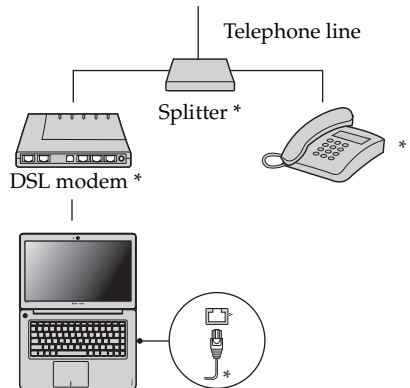

* Not supplied.

Note: The above diagrams are for reference only. Actual connection method may vary.

Chapter 3. Connecting to the Internet

■ Software configuration

Consult your Internet Service Provider (ISP) for details on how to configure your computer.

■ ■ Wireless connection

Wireless connections provide mobile access to the Internet, allowing you to stay online anywhere the wireless signal covers.

Divided by the signal scales, wireless connection to the Internet can be built based on the following standards.

Wi-Fi	Wi-Fi networks cover a small physical area, like a home, office, or small group of buildings. An access point is necessary for the connection.
WiMAX	WiMAX networks connect several Wireless LAN systems to cover a metropolitan area, providing high-speed broadband access without the need for cables.

Note: Your computer may not support all wireless connection methods.

■ Using Wi-Fi/WiMAX (on select models)

Enabling wireless connection

To enable wireless communications, do the following:

Press  to make configuration.

Hardware connection

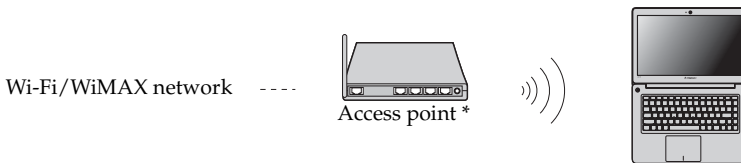

* Not supplied

Software configuration

Consult your Internet Service Provider (ISP) and search Windows Help and Support Center for details on how to configure your computer.

Chapter 4. OneKey Rescue system

■ OneKey Rescue system

■ Introduction

The Lenovo OneKey Rescue system is an easy-to-use application that can be used to back up the data on your system partition (C drive) for easy restore when required. You can run Lenovo OneKey Recovery under the Windows operating system, and the OneKey Rescue system without starting the Windows operating system.

⦿ **Attention:**

In order to utilize the features of the OneKey Rescue system, your hard disk already includes a hidden partition by default to store the system image file and OneKey Rescue system program files. This default partition is hidden for security reasons and is the reason the available disk space is less than it claims. The exact available hard disk space depends on the file size of the mirror image file (based on the size of operating system and preinstalled software).

■ Using Lenovo OneKey Recovery (within Windows operating system)

In Windows operating system, double click the OneKey Recovery system Icon on the desktop to launch Lenovo OneKey Recovery.

Within the program, you can back up the system partition on the hard disk drive, other storage devices, or by creating recovery discs.

Note:

- The backup process and creation of recovery discs may take some time, connect the AC adapter and battery pack to your computer.
- After the recovery discs are burned, please number them so that you can use them in the correct order.
- Computers without an integrated optical drive support the creation of recovery discs; however an appropriate external optical drive is needed to physically create the recovery discs.

For more instructions, see the Help file of Lenovo OneKey Recovery.

■ Using Lenovo OneKey Rescue system (without Windows operating system)

In the event that the operating system cannot be loaded, follow the steps below to access OneKey Rescue system.

- Shut down your computer.
- Press the **⌫** key to launch OneKey Rescue system.

Within the program, you can choose to restore your system partition to the original factory status, or to a previously generated backup.

Note: The recovery process is irreversible. Make sure to back up any critical data before using the recovery feature.

■ Creating a recovery disc(s)

Your computer does not ship with a recovery disc. You can use Lenovo OneKey Recovery system to create a recovery disc(s), which can be used to start and restore your computer in case of a system failure.

To create a recovery disc(s):

- Insert a recordable disc into the optical drive on your computer.

Note: If your computer does not come with an integrated optical drive or if the integrated optical drive does not support disc creating, connect an appropriate external optical drive to your computer.

- In Windows, press the OneKey Rescue system button to launch Lenovo OneKey Recovery system.

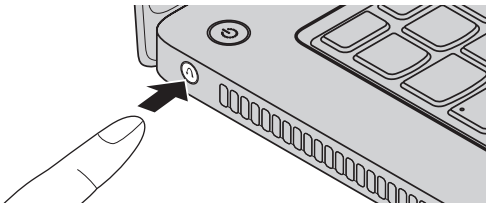

- On the main screen, click **Create Recovery Disc**.
- Choose the type of recovery disc(s). You can create three types of recovery disc(s): recovery disc(s) with existing backup image, recovery disc(s) from the current system partition, and factory default recovery disc(s). Select the type of recovery disc you want to create and follow the on-screen instructions.

Chapter 4. OneKey Rescue system

- Insert additional recordable disc(s) when prompted.

Note:

- The estimated number of discs needed will be displayed before the process of creating the recovery disc(s) begins. To minimize the number of discs needed, use recordable DVDs as the media. Also make sure your optical drive is compatible with the disc intended for use.
- After recovery disc creation, number the discs appropriately for use in their correct order. The first disc created will be used to start the computer in the case of a system failure.

Chapter 5. Troubleshooting

■ ■ Frequently asked questions

This section lists frequently asked questions and tells where you can find detailed answers.

What safety precautions should I follow when using my computer?

See “Chapter 1. Important safety information” of *Lenovo Safety and General Information Guide*.

How can I prevent problems with my computer?

See “Chapter 2. Use and care Information” of *Lenovo Safety and General Information Guide*.

What are the main hardware features of my computer?

More information can be found in Chapter 1 and 2.

Where can I find the detailed specifications for my computer?

See <http://consumersupport.lenovo.com>.

Where are the recovery discs?

Your computer did not come with a recovery disc. For an explanation of the alternative recovery methods offered by Lenovo, see “Chapter 4. OneKey Rescue system” on page 28.

Where are the installation discs for pre-installed software?

Your computer does not come with installation discs for the pre-installed software. Installation programs for the pre-installed software on your computer can be downloaded from Lenovo’s consumer support Web site (<http://consumersupport.lenovo.com>). If your computer is pre-installed with Windows operating system, you can also find installation programs for some pre-installed software in the **Application** folder on D partition of the hard disk drive.

How can I contact the customer support center?

See “Chapter 3. Getting help and service” of *Lenovo Safety and General Information Guide*.

Chapter 5. Troubleshooting

Where can I find warranty information?

For the warranty applicable to your computer, including the warranty period and type of warranty service, see the Lenovo limited warranty flyer that came with your computer.

Where can I find the device drivers?

A compatible device driver is a requirement to ensure correct operation and performance of each component in your computer. All the device drivers for your computer model can be downloaded from Lenovo's consumer support Web site. If your computer is pre-installed with Windows operating system, you can also find device drivers for the operating system in the **Driver** folder on D partition of the hard disk drive. Lenovo's consumer support Web site contains the most updated device drivers.

What can I do if the backup process fails?

If you can start the backup feature without a problem, but it fails during the backup process, please try the following steps:

- ❶ Close other programs, then restart the backup process.
- ❷ Check if the destination media is damaged, try to select another path and then try again.

When do I need to restore the system to the factory status?

You can use this feature when your system fails or you need to re-install your operating system. This will restore your computer back to the initial status when you first booted up your computer after receiving it from the store. If there is critical data on your current partition, back it up before you run this recovery feature.

■ ■ Troubleshooting

If you do not find your problem here, see Chapter 2. The following section only describes problems that might negate the need to refer to the more comprehensive information in Chapter 2.

Display problems

When I turn on the computer, nothing appears on the screen.

- If the screen is blank, make sure that:
 - The AC adapter is connected to the computer and the power cord is plugged into a working electrical outlet.
 - The computer power is on. (Press the power button again for confirmation.)
- If these items are properly set, and the screen remains blank, have the computer serviced.

When I turn on the computer, only a white cursor appears on a blank screen.

- Restore backed-up files to your Windows environment or the entire contents of your hard disk to the original factory contents using OneKey Rescue system. If you still see only the cursor on the screen, have the computer serviced.

My screen goes blank while the computer is on.

- Your screen saver or power management may be enabled. Do one of the following to exit from the screen saver or to resume from sleep or hibernation mode:
 - Touch the touchpad.
 - Press any key on the keyboard.
 - Press the power button.

Chapter 5. Troubleshooting

Password problems

I forgot my password.

- If you forget your user password, you must take your computer to a Lenovo authorized servicer or a marketing representative to have the password changed.
- If you forget your HDD password, a Lenovo authorized servicer cannot reset your password or recover data from the hard disk. You must take your computer to a Lenovo authorized servicer or a marketing representative to have the hard disk drive replaced. Proof of purchase is required, and a fee will be charged for parts and service.
- If you forget your administrator password, a Lenovo authorized servicer cannot reset your password. You must take your computer to a Lenovo authorized servicer or a marketing representative to have the system board replaced. Proof of purchase is required, and a fee will be charged for parts and service.

Sleep or hibernation problems

The critical low-battery error message appears, and the computer immediately turns off.

The computer enters sleep mode immediately after Power-on self-test (POST).

- The battery power is getting low. Connect the AC adapter to the computer, or replace the battery with a fully charged one.
- Make sure that:
 - The battery is charged.
 - The operating temperature is within the acceptable range. See “Chapter 2. Use and care Information” of *Lenovo Safety and General Information Guide*.

Note: If the battery is charged and the temperature is within range, have the computer serviced.

The computer does not return from sleep mode and the computer does not work.

- If the computer does not return from sleep mode, it may have entered hibernation mode automatically because the battery is depleted. Check the power indicator.
- If your computer is in sleep mode, connect the AC adapter to the computer, then press any key or the power button.
- If your computer is in hibernation mode or power-off state, connect the AC adapter to the computer, then press the power button to resume operation.

Note: If the system still does not return from sleep mode, your system has stopped responding, and you cannot turn off the computer; reset the computer. Unsaved data may be lost. To reset the computer, press and hold the power button for 4 seconds or more. If the computer is still not reset, remove the AC adapter.

Computer screen problems

The screen is blank.

- Do the following:
 - If you are using the AC adapter, or using the battery, and the battery status indicator is on, press  to make the screen brighter.
 - If the power indicator is in blinking, press the power button to resume from the sleep mode.
 - If the problem persists, follow the solution in the following problem "The screen is unreadable or distorted."

The screen is unreadable or distorted.

- Make sure that:
 - The display device driver is installed correctly.
 - The screen resolution and color quality are correctly set.
 - The monitor type is correct.

Incorrect characters appear on the screen.

- Did you install the operating system or programs correctly? If they are installed and configured correctly, have the computer serviced.

Chapter 5. Troubleshooting

Sound problems

No sound can be heard from the speaker even when the volume is turned up.

- Make sure that:
 - The Mute function is off.
 - The headphone jack is not used.
 - Speakers are selected as the playback device.

Battery problems

Your computer shuts down before the battery status indicator shows empty.

-or-

Your computer operates after the battery status indicator shows empty.

The computer does not operate with a fully charged battery.

- Discharge and recharge the battery.
- The surge protector in the battery might be active. Turn off the computer for one minute to reset the protector; then turn on the computer again.

A hard disk drive problem

The hard disk drive does not work.

- In the **Boot** menu in BIOS setup utility, make sure that the hard disk drive is included in the **Boot Priority Order** correctly.

A startup problem

The Microsoft® Windows operating system does not start.

- Use the OneKey Rescue system to help solve or identify your problem. For details about OneKey Rescue system, see “Chapter 4. OneKey Rescue system” on page 28.

Other problems

Your computer does not respond.

- To turn off your computer, press and hold the power button for 4 seconds or more. If the computer still does not respond, remove the AC adapter.
- Your computer might lock when it enters sleep mode during a communication operation. Disable the sleep timer when you are working on the network.

The computer does not start from a device you want.

- See the **Boot** menu of the BIOS setup utility. Make sure that the **Boot Priority Order** in the BIOS setup utility is set so that the computer starts from the device you want.
- Also make sure that the device from which the computer starts is enabled. In the **Boot** menu in the BIOS setup utility, make sure that the device is included in the **Boot Priority Order** list.
- Press **Fn + F12** (when **HotKey Switch** is set to **Hotkey Mode**) or **F12** (when **HotKey Switch** is set to **Legacy Mode**) when the Lenovo logo appears on the screen while the computer is starting up to select the device you want the computer starts from.

The connected external device does not work.

- Do not connect or disconnect any external device cables other than USB while the computer power is on; otherwise, you might damage your computer.
- When using a high power consumption external devices such as an external USB optical disk drive, use external device power adapter. Otherwise, the device may not be recognized, or system shut down may result.

Trademarks

The following terms are trademarks or registered trademarks of Lenovo in the United States, other countries, or both.

Lenovo

IdeaPad

OneKey

Microsoft and Windows are trademarks of Microsoft Corporation in the United States, other countries, or both.

Other company, products, or service names may be trademarks or service marks of others.

lenovo[®]

New World. New Thinking.[™]
www.lenovo.com

© Lenovo China 2012

Free Manuals Download Website

<http://myh66.com>

<http://usermanuals.us>

<http://www.somanuals.com>

<http://www.4manuals.cc>

<http://www.manual-lib.com>

<http://www.404manual.com>

<http://www.luxmanual.com>

<http://aubethermostatmanual.com>

Golf course search by state

<http://golfingnear.com>

Email search by domain

<http://emailbydomain.com>

Auto manuals search

<http://auto.somanuals.com>

TV manuals search

<http://tv.somanuals.com>