

Machine type: 10051
10052

Lenovo IdeaCentre B3 Series User Guide

Version 1.0 2010.04

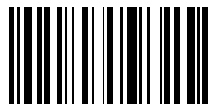

31043484



lenovo

ideacentre

Important Safety Information

Before using this manual, it is important that you read and understand all of the related safety information for this product. Refer to the *Safety and Warranty Guide* that you received with this product for the latest safety information. Reading and understanding this safety information reduces the risk of personal injury or damage to your product.



Danger: Be aware of extremely hazardous or lethal situations.



Attention: Be aware of possible damage to programs, devices, or data.



Note: Pay attention to this important information.

Contents

Important Safety Information

Chapter 1 Using the Computer Hardware	1
1.1 Front view.....	2
1.2 Left and right view of the computer	3
1.3 Rear view of the computer.....	4
1.4 Computer stand	5
1.5 Connecting your computer	5
1.6 Important information about using the computer	9
1.7 Keyboard.....	10
1.8 Using the Remote Control	11
Chapter 2 Touch Screen Instructions	15
2.1 Touch Screen Calibration.....	16
2.2 User Gesture Instructions for the Touch screen.....	16
2.3 Attentions when using the Touch Screen	25
Chapter 3 Using the Rescue System	27
3.1 OneKey Recovery.....	28
3.2 Driver and Application Installation	28
3.3 System Setup.....	29
3.4 System Backup	30
3.5 System Recovery	30
3.6 Create Recovery Disc	30
Chapter 4 Using the Computer Software	31
4.1 Lenovo Dynamic Brightness system	32
4.2 Lenovo Eye Distance System	33

Chapter 5 System Maintenance and Recovery.....	35
5.1 Restoring the System	36
5.2 Backup and Restore.....	36
5.3 Cleaning Up the Disk	36
5.4 Checking For, and Correcting Disk Errors	37
5.5 Defragmenting the Disk(s).....	37
5.6 Performing Daily Maintenance Tasks.....	37
Chapter 6 Troubleshooting and Confirming Setup.....	39
6.1 Troubleshooting Display Problems	40
6.2 Troubleshooting Audio Problems	41
6.3 Troubleshooting Software Problems.....	41
6.4 Troubleshooting Problems with Optical Drives and Hard Disks	42
6.5 Special considerations for troubleshooting Windows	43
6.6 Wireless keyboard and mouse instructions	44

1

Chapter

Using the Computer Hardware

This chapter contains the following topics:

- Computer hardware introduction
- Information on computer connections

 **Note:** The descriptions in this chapter might vary from your computer, depending on computer models and configurations.

1

2

3

4

5

6

1.1 Front view

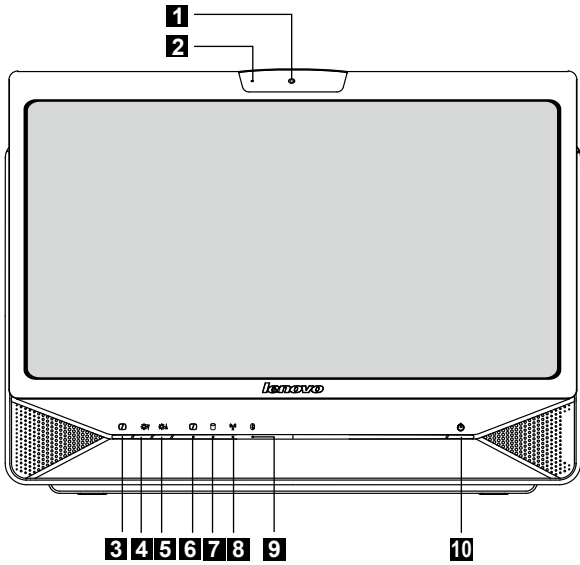

- 1** Camera
- 2** Built-in microphone
- 3** LCD On/Off
- 4** Brightness down
- 5** Brightness up
- 6** LCD On/Off indicator
- 7** Hard disk drive indicator
- 8** Wireless LAN card indicator
- 9** Bluetooth indicator
- 10** Power button

1.2 Left and right view of the computer



Attention: Be sure not to block any air vents on the computer. Blocked air vents may cause thermal problems.

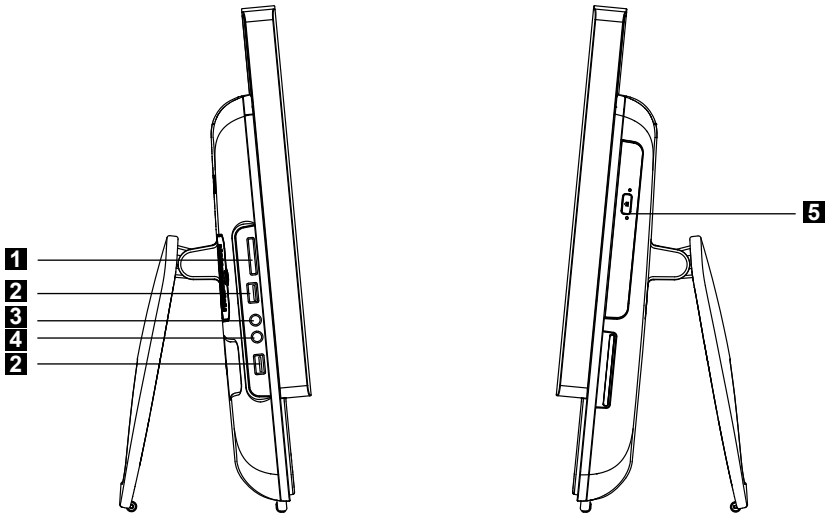

- 1** Memory card reader
- 2** USB connector
- 3** Headphone connector

- 4** Microphone connector
- 5** Optical drive

1.3 Rear view of the computer

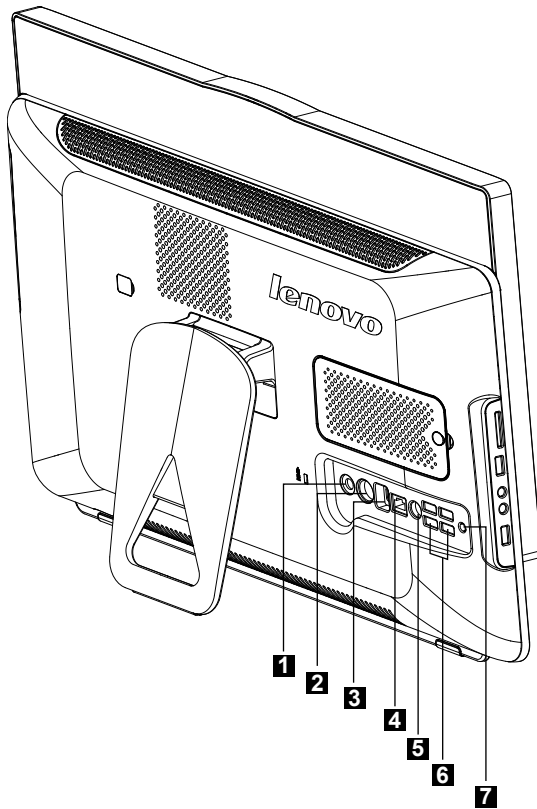

1 Power connector

2 PS/2 keyboard connector

3 IEEE 1394 connector

4 Ethernet connector

5 TV tuner connector (selected models)

6 USB ports (4)

7 Wireless reset button

1.4 Computer stand

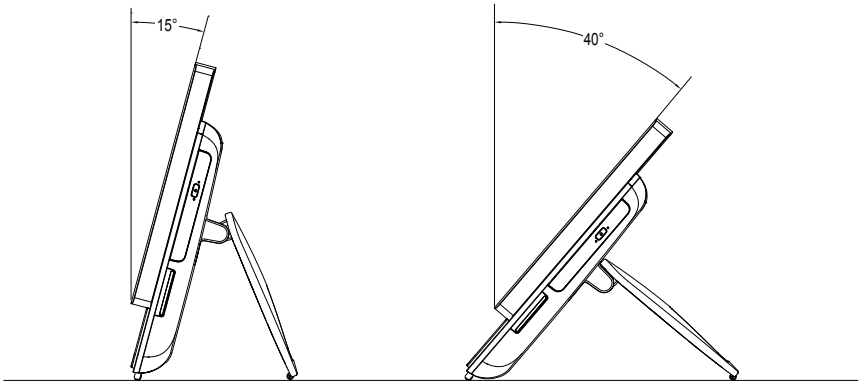

Use the stand to position the display to your preference. It can be rotated between 15° and 40° from the vertical.

The stand provides stability to the computer; it is not a removable part.



Attention:

1. The computer stand must remain installed at all times to ensure maximum system stability.
2. Make sure the angle of the computer is at least 15 degrees from the vertical; otherwise the computer will be unstable and could fall over.

1.5 Connecting your computer

Use the following information to connect your computer:

- Look for the small connector icons on the back of your computer. Match the connectors to the icons.



Note: Your computer might not have all of the connectors that are described in this section.

1.5.1 Check the voltage rating before you connect the equipment to an electrical outlet to ensure that the required voltage and frequency match the available power source.

1.5.2 Connect the keyboard cable to the appropriate keyboard connector (PS2 connector or USB connector).

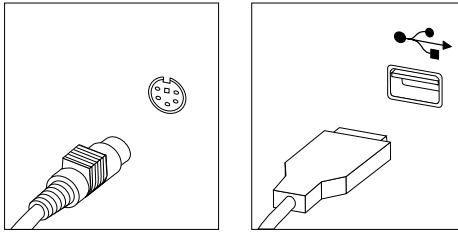

1.5.3 Connect the mouse cable to the appropriate mouse connector (USB connector).

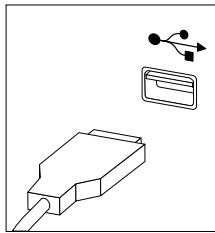

1.5.4 If you have audio devices, attach them using the following instructions:

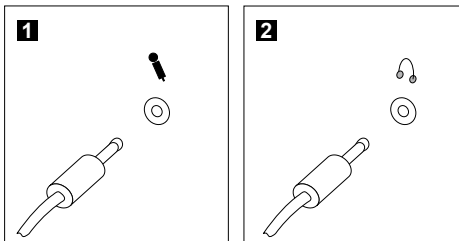

1 Microphone Use this connector to attach a microphone (purchased separately) to your computer when you want to record sound or if you use speech-recognition software.

2 Headphone Use this connector to attach headphones (purchased separately) to your computer when you want to listen to music or other sounds without disturbing anyone.

1.5.5 If you have powered speakers with an adapter:

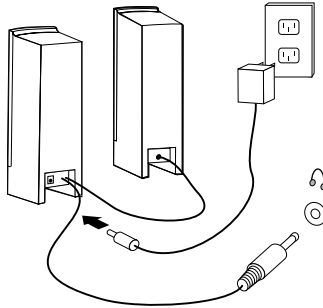

(This picture is only a sketch print, it does not show the actual figure of the speaker)

- Connect the cable that runs between the speakers if necessary. On some speakers, this cable is permanently attached.
- Connect the adapter cable to the speaker if necessary. On some speakers, this cable is permanently attached.
- Connect the speakers to the Headphone port on the computer.
- Connect the adapter to the power source.

1.5.6 If you have powered speakers without an adapter:

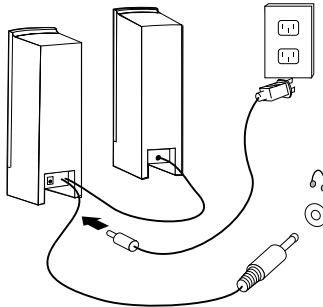

(This picture is only a sketch print, it does not show the actual figure of the speaker)

- Connect the cable that runs between the speakers if necessary. On some speakers, this cable is permanently attached.
- Connect the cable to the speaker if necessary. On some speakers, this cable is permanently attached.
- Connect the speakers to the Headphone port on the computer.
- Connect the plug to the power source.

! **Note:** Some models are not equipped with external speakers.

1.5.7 Connect any additional devices that you have. Your computer might not have all connectors shown.

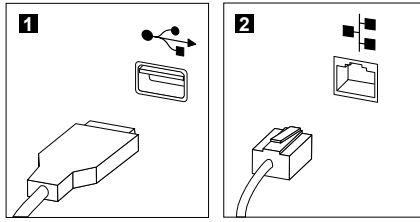

- 1 USB connector** Use this connector to attach a device that requires a USB connection.
- 2 Network adapter connector** Use this connector to attach the computer to an ethernet-type local area network.

1.5.8 Connect the power cords properly to grounded electrical outlets.

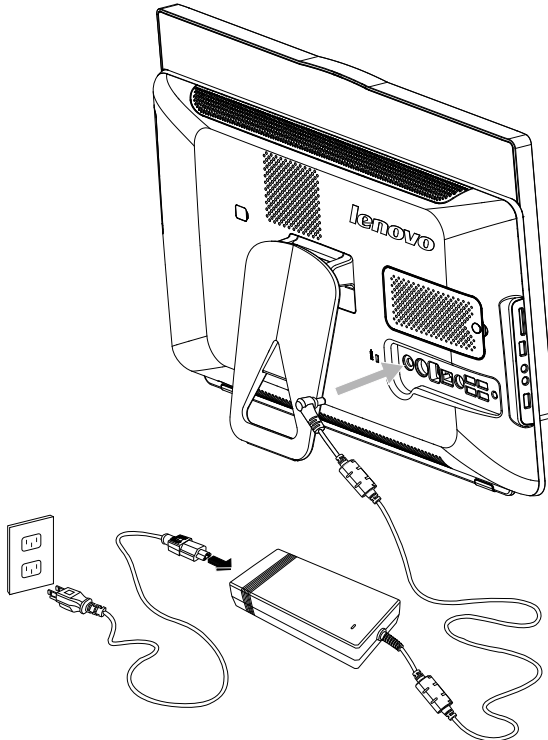

1.5.9 Your computer is equipped with a Memory Card Reader Connector, it is able to read/write data from:

MS/MS Pro/MMC/SD/SDHC

1.6 Important information about using the computer

Press the power button on the bottom right of the screen to turn on the computer.

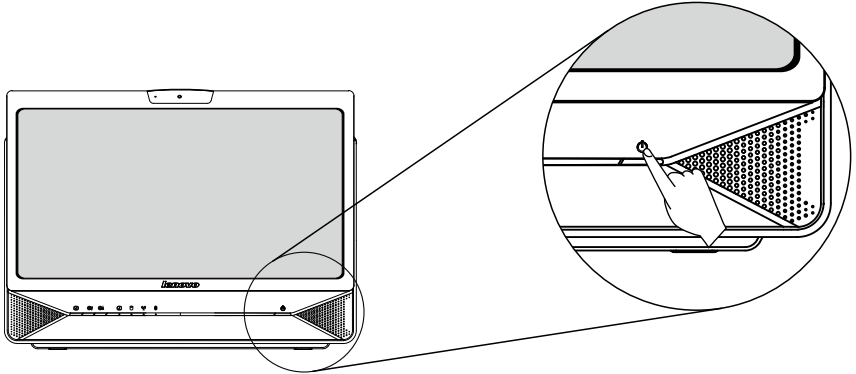

Hold the computer tightly when you carry it.

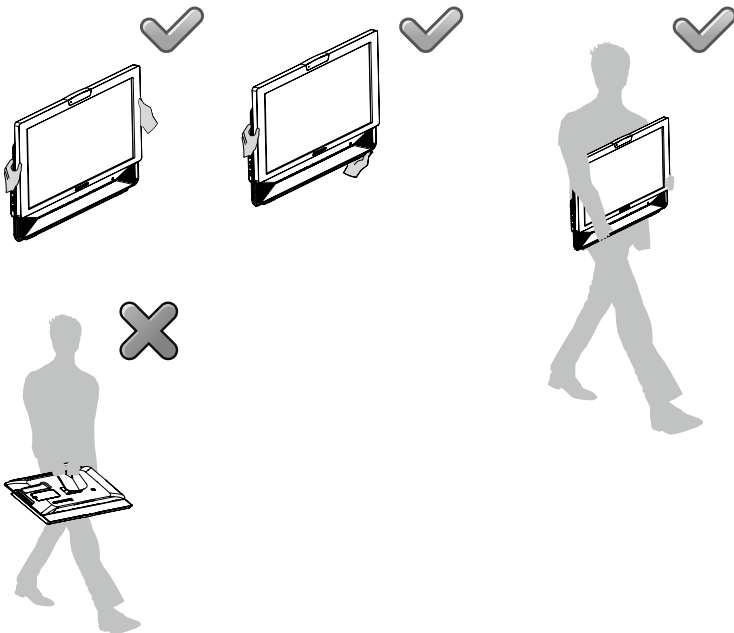

1.7 Keyboard

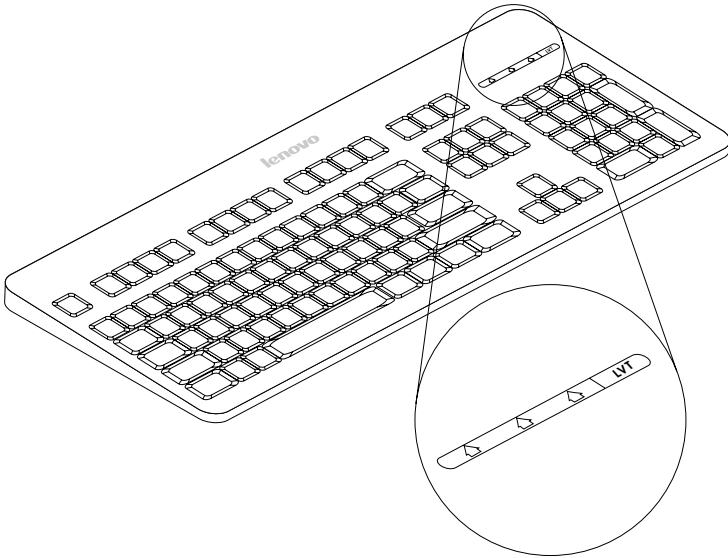







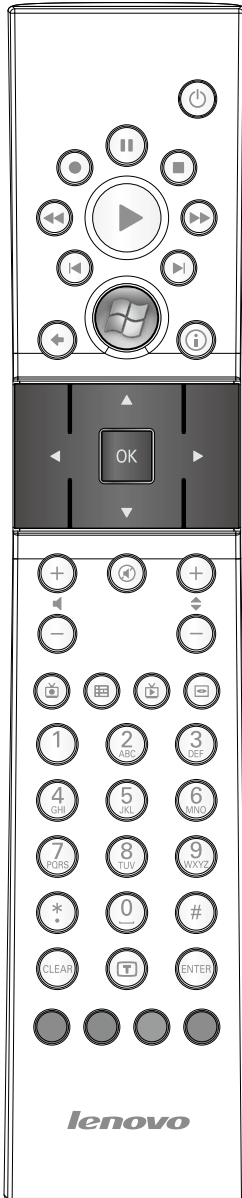









- LVT** — After entering Windows, press this key to launch the LVT (Lenovo Vantage Technology) program, Lenovo's pre-loaded Home PC software. In addition to its own functions, the LVT program will allow you to start other Windows compatible software, specially configured to run on this model of computer.
- F2** — Your computer has the Lenovo Rescue System installed. To learn more about this program, turn on the computer, and when the **Lenovo** logo appears, press the F2 key and the Lenovo Rescue System will open.







1.8 Using the Remote Control

The remote control (only shipped with some types of computers) works with the remote control receiver on the chassis. Adjust the angle of the remote control properly.



Buttons on the remote control:

Button	Description
	Up
	Down
	Left
	Right
OK	Confirm
	Back
	Details
	Guide (This function is not available in Microsoft Windows operating systems.)
	Shows live TV on the currently selected channel.
	Displays the Recorded TV page in Windows Media Center.
	Play
	Pause
	Stop
	Record
	Fast Forward
	Rewind
	Skip
	Replay

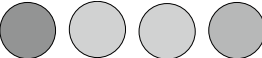
	Starts Windows Media Center.
	Turns volume up/down
	Previous/next channel
	Mute
	DVD menu
	Power supply (standby)
0~9	Number (or Letter) buttons
#	# key
*	* key
CLEAR	Clear
ENTER	Enter
	Teletext ON/OFF (Selected models only)
	Red, Green, Yellow, Blue (Selected models only)

2

Chapter

Touch Screen Instructions

This chapter contains the following topics:

- Touch Screen Calibration
- User Gesture Instructions for the Touch screen
- Attentions when using the Touch Screen



Attention: Only some models are equipped with touch screen.

1

2

3

4

5

6

The monitor has touch capability due to a touch-sensitive screen installed. A touch screen is an input device just like a mouse or a keyboard, and the user's hand transmits position information via the touch screen to the computer. With this technology, you only need to touch the pictures or words on the computer display lightly with your finger, and the computer will react.

2.1 Touch Screen Calibration

Prior to first use or whenever the touch screen reacts in a different place where you are touching it, start the calibration program. The procedure is as follows:

1. In Windows 7, Select "Start" – "Control Panel".
2. In Control Panel, select "Hardware and Sound".
3. In "Hardware and Sound" window, select "Tablet PC Settings".
4. In "Tablet PC Settings" dialogue, click "Calibrate" button.
5. Use your finger or the touch pen of 6-7mm diameter to touch each of the calibration points that are shown in sequence, to finish the calibration.

2.2 User Gesture Instructions for the Touch screen

The Touch screen supports single touches and rotational movements, enlargement and reduction multi-touch operations, and the user can transmit position information to the computer via touch. The touch screen uses a very low pressure movement recognition method, which only needs the finger to move lightly on the computer display screen or make a simple hand gesture to be detected by the main computer processor.

2.2.1 Basic Hand Gestures

1. Single Click / Double Click

For the item selected on the touch screen, with one finger touch it very gently one or two times, to perform a single click or double click operation. This is similar to the action performed by clicking the left mouse button.

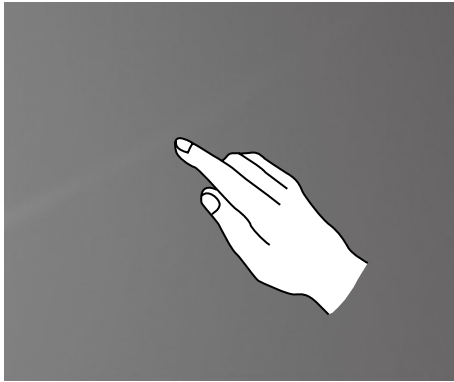

2. Single Finger Right Click

For the item selected on the touch screen, press and hold your finger on the screen until a circle appears. After lifting your finger from the touch screen, a menu bar will pop up, completing the single finger right click operation. This is similar to the action performed by clicking the right mouse button.

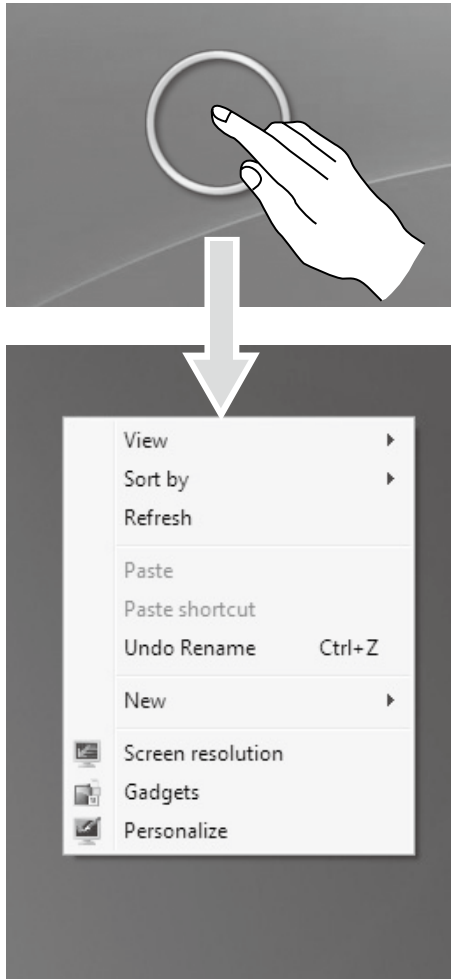

3. Dragging Movement

First touch your finger on the desired item on the screen and hold it there, then make a dragging movement. This is similar to the click and drag movement you can make with a mouse.

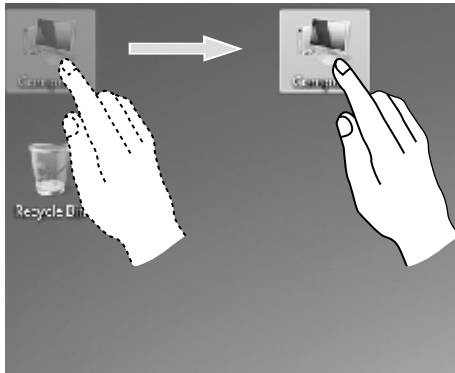

4. High Speed Slide

If you touch the screen with a single finger and slide it a short distance horizontally (about 5 cm), then quickly lift it up again, this is called a High Speed Slide, and the screen will show the **“Forward”** or **“Back”** icon.

In the default situation, a high speed horizontal sliding movement will execute a forward or back operation. For example: Forward and Back operations for the IE browser; or Previous and Next slide operations in Windows Photo Viewer slideshow mode.

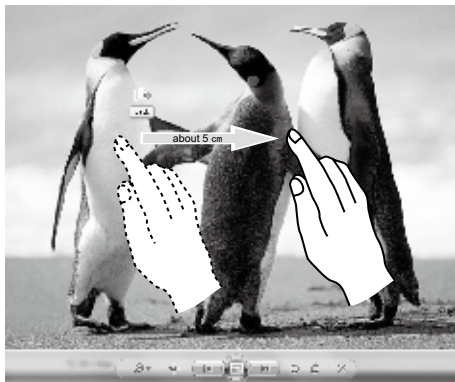

5. Rolling Movement

When you move your finger one time vertically (or horizontally) on the touch screen, this is called a Rolling Operation. This operation is similar to moving the scroll wheel on the top of a mouse, and produces the same results as the scroll wheel interface does.



6. Zoom Operation

Touch two fingers lightly on the desired item on the touch screen, then keeping both fingers on the screen, change the distance between them. By increasing (or decreasing) the distance, you can perform a zoom out (or zoom in) operation. For example: you can enlarge or reduce the picture size in Windows Photo Viewer.

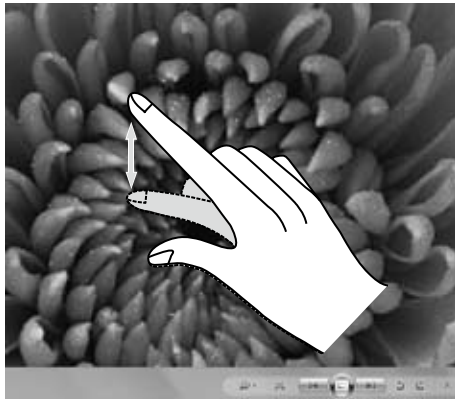

7. Rotation Operation

Use two fingers to lightly touch the desired item on the touch screen, then rotate them in the desired direction. For example: you can rotate the picture which is being displayed in Windows Photo Viewer.

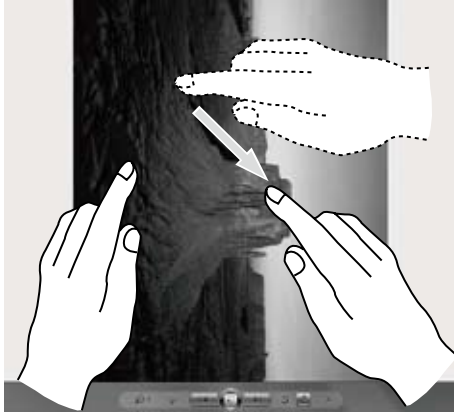

2.2.2 Related Touch Screen Settings

1. Flicks: In the notification area of the taskbar at the bottom of the screen, click on the Flicks icon, and the current Flicks window will appear. Click once anywhere in this window to enter Flicks Training. The user can perform operations according to the advice given on screen.

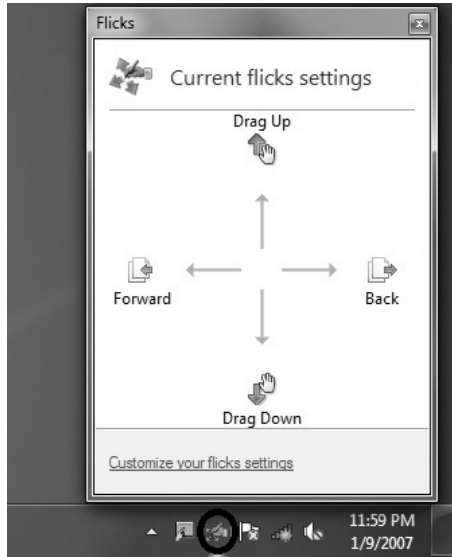

2. For more detailed configuration, you can click on the Flicks icon in the notification area of the taskbar at the bottom of the screen, then click on **“Customize your flicks setting”** in the Flicks pop-up window. In the **“Pen and Touch”** window, the user can adjust more settings related to **“Pen and Touch”** according to their specific preferences.

On the Flicks menu you can:

- Select commonly used Flicks operation groups
- Adjust the sensitivity of the touch screen

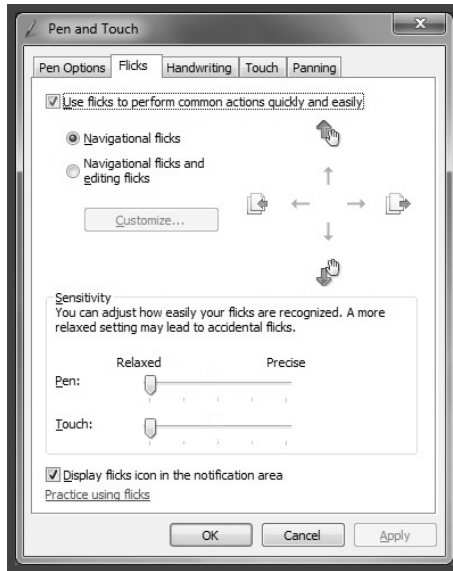

On the Touch menu you can:

- Enable / disable options such as **“Use your finger as an input device”** and **“Enable multi-touch gestures and inking”**.
- Select touch actions which you wish to adjust. By clicking on **“Settings”**, you can adjust the **“Speed”** and **“Spatial tolerance”** parameters, to match the user’s natural way of double-clicking. You can double-click on the lower right corner of the icon to test this.
- Enable / disable touch points.

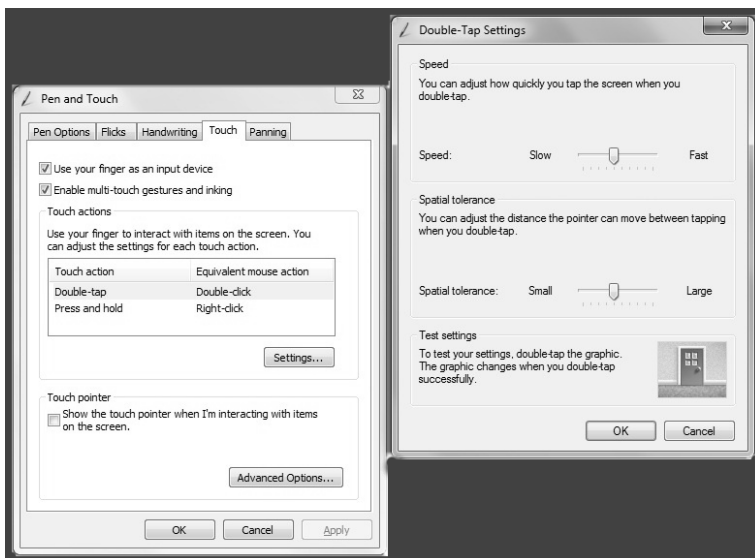

! Note: Users can access more help information from the Windows **“Help and Support”** menu.

2.3 Attentions when using the Touch Screen

1. With the new touch recognition technology of Touch Screen, the user only needs to gently tap on the touch screen, and does not need to exert any pressure to complete operations. When using it please remember not to use excessive force or tear the screen surface with any sharp object.

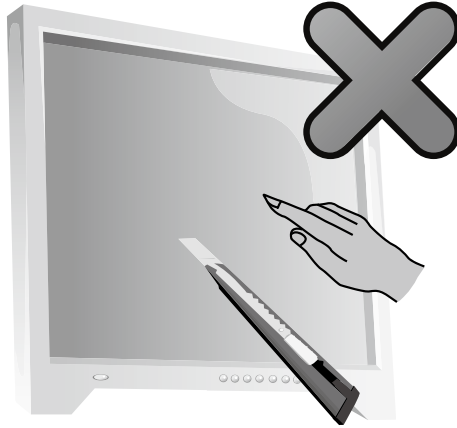

2. In order to safeguard it for normal use, you should remove any dirt from the touch screen, and ensure your fingers are clean and dry, as well as avoid using it in dusty environments, or in very hot or humid conditions.
3. The product casing is easy to clean. To ensure safe use, we suggest you clean the screen and casing with a soft cotton cloth after turning it off each time. When wiping the screen, please do not wipe in an upwards direction, but wipe it in a direction from top to bottom.
4. Please promptly remove any dust accumulated in the four corners of the screen and the bottom of the screen frame, because this will prevent accumulated dust from affecting the screen's touch localization. Do not place or drop anything which could obstruct it in the four corners of the screen or any part of its frame, because this could separate the screen from the frame and stop the screen from being able to sense position properly.

! **Note:** When it is used in normal operation, the touch screen process will not affect the running of other computer processes.

5. The recognition of touch gestures by this product can be influenced by the following factors:

- Touching the correct place on the screen
- The speed of movement
- The time interval from when the screen was last touched



Note: To learn accurate hand gesture operations, the user can consult this manual and also the related Windows help content.

6. In order to achieve a better degree of sensitivity from the touch screen, the user should avoid placing the screen too close to an artificial light source or in the direct path of strong sunlight.
7. The touch screen does not function in Rescue System mode.
8. The touch screen also does not function during the startup process, and in Sleep mode or Safe mode.

3

Chapter

Using the Rescue System

This chapter contains the following topics:

- OneKey Recovery
- Driver and Application Installation
- System Setup
- System Backup
- System Recovery
- Create Recovery Disc



Attention: Using this program will result in a loss of data.

- You can recover the C drive of the computer to the factory default settings or to the last system backup status using **OneKey Recovery**. With this operation, all of the existing data on drive C will be lost, whereas the content and format of the other partitions of the hard disk drive will remain unchanged.
- If you want to install an operating system and back it up with **OneKey Recovery**, you must format the C partition in **NTFS** format and install the operating system on the C partition. Otherwise, the **OneKey Recovery** system cannot run.

1

2

3

4

5

6

Note about the service partition:

The files and relevant data used by the rescue system are saved in the service partition. Deleting this partition will make the rescue system unusable. For more detailed information, see the following instructions:

By selecting **Control Panel** → **Administrative Tools** → **Computer Management** → **Disk Management**, you can see the service partition, which must not be deleted.

 **Note:** The recovery files and relevant data used by the rescue system are saved in the service partition. If the service partition is deleted or damaged by someone other than authorized Lenovo servicers, Lenovo will not be liable for any losses arising there from in any way.

3.1 OneKey Recovery

OneKey Recovery is an easy-to use application. You can use it to restore your computer to the system default or a previously backed up state.

Detailed Operation Procedure

1. Turn on the computer. When the *Lenovo* logo appears, press the **F2** key on the keyboard to start the **Rescue System**, then you can select **OneKey Recovery**.

 **Note:** System Recovery will overwrite all of the data on drive C. To prevent loss of data, be sure to back up relevant data before performing system recovery.

2. Follow the onscreen instructions to select the backup task you want to restore from and disk you want to install operation system, and press **Next** to start restoration.
3. Please wait during the process of system recovery. Do not interrupt the operation during the recovery process.
4. After the system is recovered successfully, the software prompts to restart the computer. Restart the computer and enter the system.

3.2 Driver and Application Installation

The Driver and Application Installation function in the rescue system provides a way for the user to conveniently re-install all of the Lenovo applications and drivers that were shipped with your Lenovo hardware.

Method 1: Automatic Installation

Turn on the computer. When the Lenovo logo appears, press the **F2** key on the keyboard to start the **Rescue System**, then select **Drivers and Application Installation**.

Follow the screen prompts to install the Lenovo Drivers and Application Installation. Click **Install** to start installing the Lenovo Drivers and Application Installation.

The system will restart. After the system has restarted, the installation process will continue until completion.

Method 2: Manual Installation

In the Windows system, Click **Start** → **All Programs** → **Lenovo** → **Lenovo Drivers and Application Installation**.

After starting the procedure, install all the drivers and software manually according to the prompts.

Notes:

1. It is recommended not to install the software which is already on the computer.
2. Before accessing the operating system, make sure that the Drivers and Application installation has been installed automatically. After that, the manual installation function can be used.

3.3 System Setup

System Setup configures the network configuration for the Lenovo Rescue System to ensure your Rescue System can connect to internet. In addition, System Setup sets and manages all passwords for the Lenovo Rescue system.

3.3.1 Launch

Turn on the computer. When the *Lenovo* logo appears, press the **F2** key to launch **Rescue System**. Then select **System Setup**.

3.3.2 Network Settings

Depending on the network access mode of the computer, select “ADSL” or “LAN Connection” in the network connection modes.

1. If you select “ADSL,” input the username and password of the ADSL connection.

2. If you select “LAN connection,” configure the IP address and proxy server of the LAN.

3.3.3 Password Management

Password Management allows you to set the password for Lenovo Rescue System and manage it.

The default password is blank.

Set a password when you access the **Password Management** for the first time. If you don't want to set a password, access the system directly and operate accordingly.

3.4 System Backup

Back up your system partition to an image file. In case of a system failure, you can restore your system from this image file.

In the Windows system, click **Start** → **All Programs** → **Lenovo** → **Lenovo Rescue System**.

After starting the procedure, click **System Backup** to back up your system partition according to the prompts.

3.5 System Recovery

Reboot your computer into the system recovery environment. You can choose to restore to a system backup point or the initial state.

3.6 Create Recovery Disc

Create a bootable recovery disc from current system. These recovery discs are used to boot your computer and will guide you through the entire restoration process.

In the Windows system, click **Start** → **All Programs** → **Lenovo** → **Lenovo Rescue System**.

After starting the procedure, click **Create Recovery Disc** to create a bootable recovery disc from current system.

Follow the screen prompts to create recovery discs.

4

Chapter

Using the Computer Software

This chapter contains the following topics:

- Computer software instructions

 **Note:** The interface and function of each of these features are subject to the actual software that was shipped with the computer model that you purchased.

1

2

3

4

5

6

4.1 Lenovo Dynamic Brightness system

Lenovo Dynamic Brightness System can automatically detect the surrounding ambient brightness and will adjust display brightness accordingly. You can set the screen brightness to a comfortable level for different environments. You can also set the display delay time to automatically turn off the display when you are away from the computer.

! **Note:** The Auto Switch Display function can not be used when your computer is in standby mode, sleep mode or turned off.

! **Note:** This function applies only to the computer equipped with a Lenovo PC camera and is available only after the camera is installed.

Before using this software, do the following:

1) Click **Start** → **All Programs** → **Lenovo USB2.0 UVC Camera** → **vmcap**.

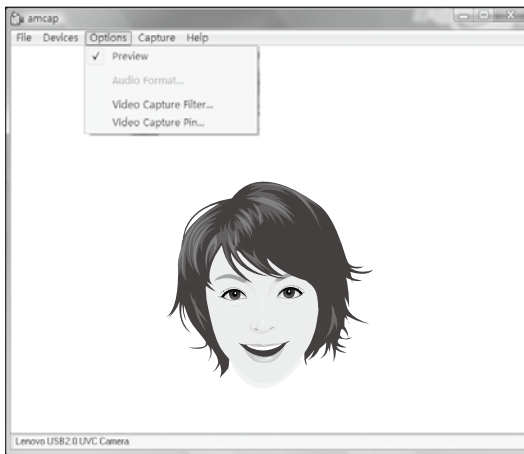

2) Select **Options** → **Preview** from the pop-up window to display the image in the video capture window.

! **Note:** If there is no image display in the AMCAP video capture window, please confirm that preview in the options has been checked.



- 3) Confirm that **Devices** → **Lenovo USB2.0 UVC Camera** has been checked. If there are other devices in this option, do not check them. Only choose the “**Lenovo USB2.0 UVC Camera**” device, and the window should display the camera image. An image, which is caught by Lenovo PC camera, will be displayed in the video capture window. Adjust the position and pitch angle of the camera to ensure the whole face is displayed in the video capture window.

To use this software, do the following:

Click **Start** → **All Programs** → **Lenovo** → **Lenovo Dynamic Brightness system**.

The default setting has been pre-selected. You can adjust the brightness and display delay time according to your needs.

4.2 Lenovo Eye Distance System

Lenovo Eye Distance System can automatically detect the distance between you and the display. It will alert you automatically when you sit too close to the display. You can also set viewing distance as well as the time interval beyond which a warning will pop up.

! **Note:** This function applies only to the computer equipped with a Lenovo PC camera and is available only after the camera is installed.

To use this software, do the following:

Click **Start** → **All Programs** → **Lenovo** → **Lenovo Eye Distance System**.

The default setting has been pre-selected. You can adjust the viewing distance according to your needs.

 **Notes:**

1. Ensure the lens of the camera is exposed and not covered.
2. Ensure your eyes are exposed and not covered.

(The function that detects the distance between the user and monitor is based on the position of the user's eyes. Therefore, if the eyes are covered or there is a strong reflection, the distance detection may be affected.)

Wear glasses may affect the accuracy of the face image verification.

3. The limitation of the distance detection by the camera:

The minimum distance : about 20 centimeters (7.90 inches)

The maximum distance : about 70 centimeters (27.55 inches)

The pitch angle (the face rotary angle scope in the vertical):

Elevation angle: 20 degrees

Depression angle: 30 degrees

The horizontal rotary angle (the face rotary angle scope in the horizontal): -20 ~ +20 degrees

5

Chapter

System Maintenance and Recovery

This chapter contains the following topics:

- Daily Maintenance and Tools Instructions

1

2

3

4

5

6

5.1 Restoring the System

The system can develop problems due to erroneous operation or the installation of additional software. If software problems develop in the originally installed software, you can restore the system by using system backup and restoration features.

 **Note:** The existing system settings will change after restoration. Check the settings of the restored system to ensure they match settings that may be critical to your needs.

Use the following procedure to restore the software to a known functional level:

1. Click **Start** → **All Programs** → **Accessories** → **System Tools** → **System Restore**.
2. Choose either the recommended restore point, or select a different recovery time from the pop-up box. Choose the latest date when the system was running properly.
Click **Next** to continue.
3. The system will start restoration. When all processes run to completion, the system displays a message informing you that the restore operation has completed successfully.

5.2 Backup and Restore

For security purposes, you can back up the system status before you install additional software, or otherwise modify system settings. To back up the system status, do the following:

1. Click **Start** → **All Programs** → **Maintenance** → **Backup and Restore**.
2. Select the location for your backup. Click **Next** and follow the instructions to continue.

5.3 Cleaning Up the Disk

Do the following periodically to clean up the disks and possibly enhance your computer's performance:

1. Click **Start** → **All Programs** → **Accessories** → **System Tools** → **Disk Cleanup**.
2. Choose the disk you want to clean up.
3. Click the **OK** button to start the cleanup process.

5.4 Checking For, and Correcting Disk Errors

To properly maintain your system, you should periodically check for and fix hard disk errors by doing the following:

1. Right-click the icon for the hard disk drive (HDD) that you want to reorganize, then select **Properties** from the pop-up menu.
2. Select the **Tools** tab, and then click **Check Now**.
3. Check your inspection items for the disk and click **Start**.



Note: You cannot start error checking until the computer is restarted and initialized.

5.5 Defragmenting the Disk(s)

Disk fragments are tiny unused storage areas scattered on the disk. The system cannot directly reutilize these “blank” spaces and system performance can decrease as system operations usually cause the number of unused storage gaps to increase. To defragment your disk storage, do the following:

1. Right-click the icon for the hard disk drive (HDD) that you want to reorganize, then select **Properties** from the pop-up menu.
2. Go to the **Tools** tab from disk **Properties** and select **Defragment Now**.
3. Select the time and scheme to be used by the defragging program, then start the defragmenting program. Depending on the amount of defragmentation on the hard disk drive, this procedure can take a long time (sometimes more than one hour).

5.6 Performing Daily Maintenance Tasks

Cleaning the computer components

Because many of the computer components consist of sophisticated integrated circuit boards, it is very important to periodically clean around the computer to prevent dust buildup. The cleaning supplies you need in order to clean the components include: a vacuum cleaner, a soft cotton cloth, clear water (pure water preferred) and cotton swabs.



Attention: Before you clean your computer, disconnect the computer from the electrical outlet. Clean your computer with a soft cloth dampened with water. Do not use liquid or aerosol cleaners, which may contain flammable substances.



Note: To avoid damaging the computer or display, do not spray cleaning solution directly onto the display. Only use products specifically designed for cleaning displays, and follow the instructions that are included with the product.

The following are general methods for cleaning the components:

- You can use a soft cloth to remove dust on the surface of the computer, the monitor, the printer, the speakers and the mouse.
- You can use a vacuum cleaner to clean in otherwise inaccessible corners.
- To clean the keyboard thoroughly, shut down the computer and scrub it gently with a wet cloth.
- Do *not* use the keyboard until it is dry.

Do not do any of the following:

- Allow water to enter the computer
- Use a heavily dampened cloth
- Spray water directly onto the surface of the monitor or inside of computer

Daily attention should be given to LCD monitors. Use a dry cloth daily to brush dust from the monitor and keyboard. Keep all surfaces clean and free of grease stains.

6

Chapter

Troubleshooting and Confirming Setup

This chapter contains the following topics:

- Troubleshooting and Problem Resolution

 **Note:** The description of the TV-Tuner card in this manual is only used for the machines which have the TV-Tuner card. It does not apply to those machines that do not have a TV-Tuner card.

1

2

3

4

5

6

Solving Problems

Follow these tips when you troubleshoot your computer:

- If you added or removed a part before the problem started, review the installation procedures and ensure that the part is correctly installed.
- If a peripheral device does not work, ensure that the device is properly connected.
- If an error message appears on the screen, write down the exact message. This message may help support personnel diagnose and fix the problem(s).
- If an error message occurs in a program, see the program's documentation.

 **Note:** The procedures in this document were written for the Windows default view, so they may not apply if you set your Lenovo® computer to the Windows Classic view.

6.1 Troubleshooting Display Problems

Problem: Blank screen or no image is displayed on the monitor.

Troubleshooting and problem resolution:

Check that the LCD screen has been turned on; If not, press the LCD On/Off button to turn on the LCD.

If still cannot solve the problem, contact to Lenovo Customer Service.

Problem: You need to change display property settings.

Setting display background and icon properties:

1. Right-click the desktop anywhere except over an icon, then select Personalize from the pop-up menu.
2. From here, select the appropriate options to:
 - Change the desktop background
 - Select a screen saver
 - Select colors and appearance options for icons and characters
 - Set resolution and colors by using **Display Settings** options

Problem: Ripple on screen

Troubleshooting and problem resolution:

1. Check for devices located less than one meter from the computer such as refrigerators, electric fans, electric dryers, UPSs, regulators, fluorescent lamps or other computers that may be generating magnetic interference.

2. Move any interfering devices away from the computer.
3. If the problem persists, consult with Lenovo Service.

6.2 Troubleshooting Audio Problems

Problem: No sound from integrated speakers.

Troubleshooting and problem resolution:

- Adjust the windows volume control — Double-click the speaker icon in the lower-right corner of your screen. Ensure that the volume is turned up and that the sound is not muted. Adjust the volume, bass, or treble controls to eliminate distortion.
- Reinstall the audio driver.
- Disconnect headphones from the headphone connector — Sound from the speakers is automatically disabled when headphones are connected to the computer's side-panel headphone connector.

Problem: No sound from headphones.

Troubleshooting and problem resolution:

- Check the headphone cable connection — Ensure that the headphone cable is securely inserted into the headphone connector.
- Adjust the windows volume control — Click or double-click the speaker icon in the lower-right corner of your screen. Ensure that the volume is turned up and that the sound is not muted.

6.3 Troubleshooting Software Problems

Problem: You are unable exit a running program normally.

Troubleshooting and problem resolution:

1. Open the Task Manager window by pressing Ctrl, Alt and Delete at the same time.
2. Select the Application tab, select the problem program, and then click the End Task button.

Problem: You need to install or uninstall a program.

Problem resolution:

During installation never abort the install process by powering the system off or through other drastic means. This can cause system program disorder or even failure during system initialization.

During the uninstall process, never directly delete the files or folders. This is harmful to the system, and might cause a system-wide malfunction.

Use the following procedure to properly uninstall programs:

1. Back up all documents and system settings related to the program before removing it.
2. If the program has its own uninstaller, run it directly to uninstall the program.
3. If the program does not have its own uninstaller, then select Control Panel from **Start** menu.
4. From the **Control Panel**, choose **Programs and Functions**.
5. Find the applicable program from the **Programs and Functions** dialog box and then select **Uninstall/Modify**.
6. Perform the instructions displayed to uninstall the software.

6.4 Troubleshooting Problems with Optical Drives and Hard Disks

Problem: The Optical drive is unable to read a CD/DVD.

Troubleshooting and problem resolution:

1. Check to determine if there is an optical drive icon in the resource manager of the operating system. If not, restart your computer. If there is still no icon, contact Lenovo Service. Otherwise, continue with the next step of this procedure.
2. Confirm that the CD/DVD has been properly placed in the drive. If not, reload the CD or DVD. Otherwise, continue with the next step of this procedure.
3. Check the specifications that came with your computer to confirm that this optical drive is supposed to be able to read this type of CD or DVD.
4. If the CD/DVD cannot be read, replace it with a known good CD/DVD such as one that was shipped with the computer.
5. If the known good CD cannot be read, visually check the operating side of the CD/DVD for defects.

Problem: The capacity of the hard disk, as indicated by the system, is less than the nominal capacity.

Troubleshooting and problem resolution: For computers equipped with the OneKey Recovery feature, the system recovery feature needs to occupy some hard disk space. This may account for the apparent hard disk capacity deficit.

Further Technical Explanation: The nominal capacity of the hard disk is expressed in the decimal system, 1000 bytes. But the actual hard disk capacity is expressed in the binary system as 1024 bytes (For example, the nominal capacity 1G is 1000M, while the actual capacity 1G is 1024M).

The capacity of the hard disk shown in Windows can be calculated according to the calculations in the following example:

The nominal capacity of the hard disk is 40G, while its actual capacity should be: $40 \times 1000 \times 1000 \times 1000 / (1024 \times 1024 \times 1024) = 37\text{G}$.

If the Service partition of 3G - $3 \times 1000 \times 1000 \times 1000 / (1024 \times 1024 \times 1024) = 2.79\text{G}$ is subtracted, the capacity of the hard disk shown in the system can be obtained.

The capacity of the hard disk as calculated using this method may be slightly different from the actual capacity due to the rounding of totals.

6.5 Special considerations for troubleshooting Windows

Record the following information that may later be useful in troubleshooting system problems:

1. The serial number of the software. The serial number was shipped with the computer and was provided separately by the manufacturer. The Help Center is unable to retrieve this number.
2. The drivers for this computer model only support the Windows 7 system.
3. When you use the Windows Media Center to watch TV, be particularly attentive to the following:
 - In the following two situations, you must re-save a channel list:
 - a. When you change your TV signal from digital to analog, your saved channel list for digital TV is deleted. When you want to watch digital TV again, you must create and save a new channel list.
 - b. When you change your TV signal from analog to digital, your saved channel list for analog TV is deleted. When you want to watch analog TV again, you must create and save a new channel list.

- Before you can watch teletext programming, you must set the TV tuner input signal to analog.

6.6 Wireless keyboard and mouse instructions

(Only some models are equipped with wireless keyboard and mouse)

Before using the wireless keyboard and mouse, carefully read the configuration instructions in the Quick Reference poster. If you fail to connect the wireless keyboard and mouse according to the steps shown in the Quick Reference poster, you may also connect using the instructions below.

Method 1:

1. After installing the batteries, turn on the power switches of the wireless keyboard and mouse.
2. Press the wireless connect buttons on the back of the keyboard and mouse. When the keyboard and mouse wireless indicator lights blink white, turn the computer on immediately.

 **Note:** If the wireless indicator lights stop blinking, press the connect buttons on the keyboard and mouse again.

3. After entering the system, press the wireless reset button on the back of the computer for over 6 seconds to search for wireless devices.

 **Note:** The process of searching for wireless devices could take several minutes.

4. When the wireless mouse device is found, the driver will be installed automatically.
5. When the wireless keyboard device is found, enter the PIN code and press the **Enter** key to finish the pairing process.
6. Once the wireless connection has been successfully established, the wireless keyboard and mouse will work properly.

Method 2:

 **Notes:**

- Before using the method below, enter the system and prepare a set of wired keyboard and mouse.
- If you want to install a new set of wireless keyboard and mouse, follow the steps below.

1. Using the wired keyboard and mouse to enter the system.
2. Turn on the power switches of the wireless keyboard and mouse.
3. Press the wireless connect buttons on the back of the keyboard and mouse to make the indicator lights blink white.



Note: If the wireless indicator lights stop blinking, press the connect buttons on the keyboard and mouse again.

4. To open the Devices and Printers dialog box, go to Windows and click **Start** → **Control Panel** → **Hardware and Sound**. Press **Add a device** to pop-up a dialog box.
5. Select the **Lenovo Bluetooth Mouse** and click **Next** to establish the bluetooth connection.
6. Select the **Lenovo Bluetooth keyboard** and click **Next**. (Press **Add a device** icon if the dialog box is closed and press the connect button again.)
7. Enter the pairing code and press the **Enter** key to complete the bluetooth connection.

Free Manuals Download Website

<http://myh66.com>

<http://usermanuals.us>

<http://www.somanuals.com>

<http://www.4manuals.cc>

<http://www.manual-lib.com>

<http://www.404manual.com>

<http://www.luxmanual.com>

<http://aubethermostatmanual.com>

Golf course search by state

<http://golfingnear.com>

Email search by domain

<http://emailbydomain.com>

Auto manuals search

<http://auto.somanuals.com>

TV manuals search

<http://tv.somanuals.com>