

Machine type: 10059/7723
10060/7724
10068/7752
10080/3099/1194
10091/2558/1196

Lenovo

H4 Series

User Guide

Version 3.0 2011.08



31500352



lenovo

Important Safety Information

Before using this manual, it is important that you read and understand all of the related safety information for this product. Refer to the *Safety and Warranty Guide* that you received with this product for the latest safety information. Reading and understanding this safety information reduces the risk of personal injury or damage to your product.



Danger: Be aware of extremely hazardous or lethal situations.



Attention: Be aware of possible damage to programs, devices, or data.



Note: Pay attention to this important information.

Contents

Important Safety Information

Chapter 1 Using the Computer Hardware	1
1.1 Front view of the chassis	2
1.2 Rear view of the chassis	3
1.3 Connecting your computer	8
Chapter 2 Using the Rescue System	15
2.1 OneKey Recovery	16
2.2 Driver and Application Installation	16
2.3 System Setup	17
2.4 System Backup	18
2.5 System Recovery	18
2.6 Create Recovery Disc	18
Chapter 3 Using the Computer Software	19
3.1 Lenovo Dynamic Brightness system	20
3.2 Lenovo Eye Distance System	21
Chapter 4 Troubleshooting and Confirming Setup	23
4.1 Troubleshooting Display Problems	24
4.2 Troubleshooting Audio Problems	25
4.3 Troubleshooting Software Problems	25
4.4 Troubleshooting Problems with Optical Drives and Hard Disks	26
4.5 Special considerations for troubleshooting Windows	27
4.6 Performing Daily Maintenance Tasks	28

1

Chapter

Using the Computer Hardware

This chapter contains the following topics:

- Computer hardware introduction
- Information on computer connections

 **Note:** The descriptions in this chapter might vary from your computer, depending on computer models and configurations.

1

2

3

4

1.1 Front view of the chassis



Attention: Be sure not to block any air vents on the computer. Blocked air vents can cause thermal problems.

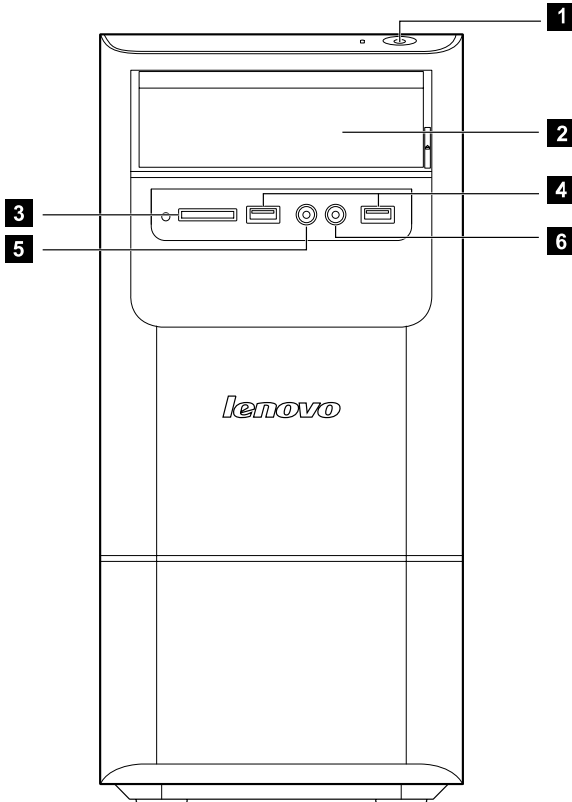

- 1** Power button
- 2** Optical Drive (Selected models only)
- 3** Memory card reader (Selected models only)
- 4** USB connector (2)
- 5** Headphone connector
- 6** Microphone connector



Note: This computer only can be placed in a vertical position.

1.2 Rear view of the chassis

(If the rear view configuration in this chapter is different from your actual computer, the rear view configuration of your actual computer should be taken as final and binding.)

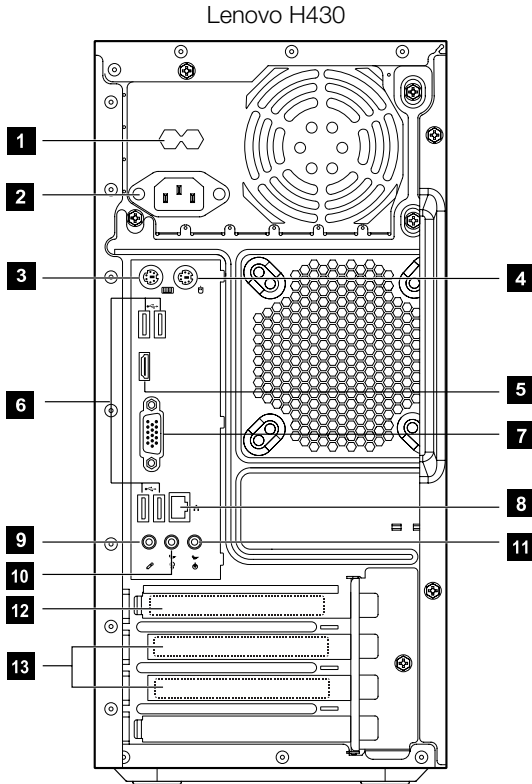

- 1** Voltage selection switch (Selected models only)
- 2** Power connector
- 3** PS/2 keyboard connector (Selected models only)
- 4** PS/2 mouse connector (Selected models only)
- 5** HDMI connector (Selected models only)
- 6** USB connectors (4)
- 7** On-board VGA connector
- 8** Ethernet connector
- 9** Microphone connector
- 10** Audio line-out connector

- 11** Audio line-in connector
- 12** Standalone graphic card (Selected models only)
- 13** Expansion card slots (Access connectors for any installed PCI express cards)

Lenovo H415

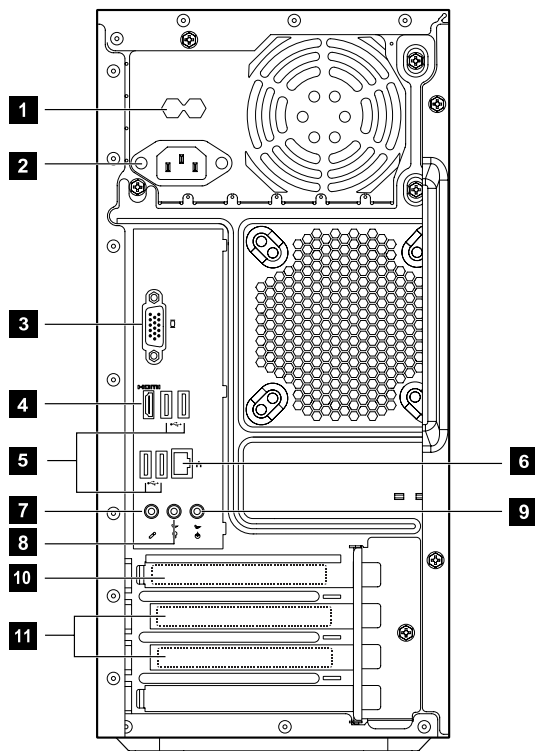

- 1** Voltage selection switch (Selected models only)
- 2** Power connector
- 3** On-board VGA connector (Selected models only)
- 4** HDMI connector (Selected models only)
- 5** USB connectors (4)
- 6** Ethernet connector
- 7** Microphone connector
- 8** Audio line-out connector
- 9** Audio line-in connector

- 10** PCI Express X 16 graphics adapter connector (Some models are equipped with a graphic card)
- 11** PCI Express X 1 adapter connector (Some models are equipped with a WIFI card or TV tuner card)

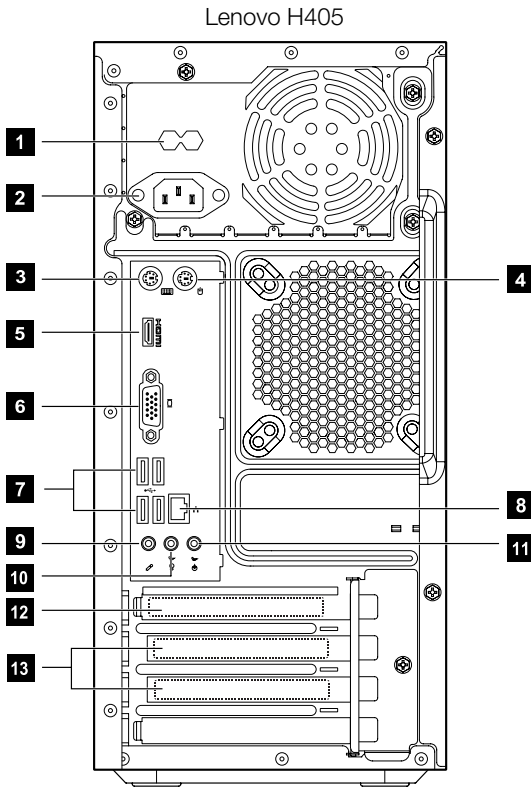

- 1** Voltage selection switch (Selected models only)
- 2** Power connector
- 3** PS/2 keyboard connector
- 4** PS/2 mouse connector
- 5** HDMI connector (Selected models only)
- 6** On-board VGA connector (Selected models only)
- 7** USB connectors (4)
- 8** Ethernet connector
- 9** Microphone connector

- 10** Audio line-out connector
- 11** Audio line-in connector
- 12** PCI Express X 16 graphics adapter connector (Some models are equipped with a graphic card)
- 13** PCI Express X 1 adapter connector (Some models are equipped with a WIFI card or TV tuner card)

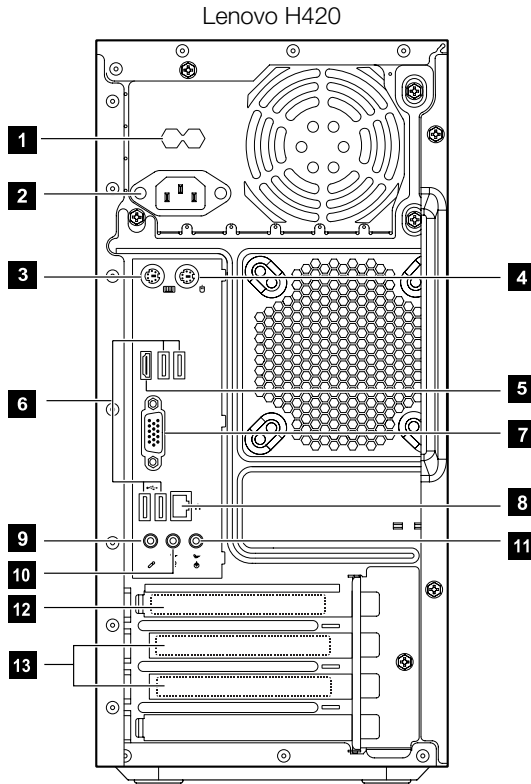

- 1** Voltage selection switch (Selected models only)
- 2** Power connector
- 3** PS/2 keyboard connector
- 4** PS/2 mouse connector
- 5** HDMI connector
- 6** USB connectors (4)

- 7** On-board VGA connector
- 8** Ethernet connector
- 9** Microphone connector
- 10** Audio line-out connector
- 11** Audio line-in connector
- 12** Standalone graphic card (Selected models only)
- 13** Expansion card slots (Access connectors for any installed PCI express cards)

Lenovo H410

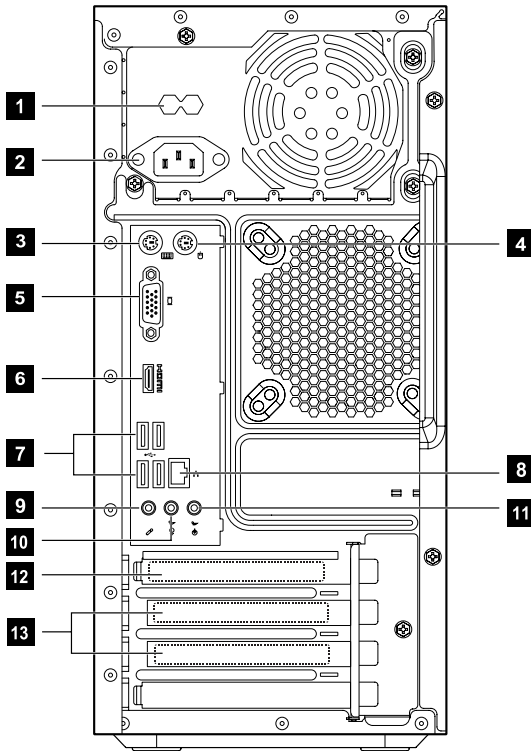

- 1** Voltage selection switch (Selected models only)
- 2** Power connector
- 3** PS/2 keyboard connector
- 4** PS/2 mouse connector
- 5** On-board VGA connector (Selected models only)

- 6** HDMI connector (Selected models only)
- 7** USB connectors (4)
- 8** Ethernet connector
- 9** Microphone connector
- 10** Audio line-out connector
- 11** Audio line-in connector
- 12** PCI Express X 16 graphics adapter connector (Some models are equipped with a graphics card)
- 13** PCI Express X 1 adapter connector (Some models are equipped with a WIFI card or TV tuner card.)

1.3 Connecting your computer

Use the following information when connecting your computer.

- Look for the small connector icons on the back of your computer. Match the connectors to the icons.
- If your computer cables and connector panel have color-coded connectors, match the color of the cable end with the color of the connector.

! **Note:** Your computer might not have all of the connectors that are described in this section.

1.3.1 Check the position of the voltage-selection switch on the rear of the computer. Use a ballpoint pen to slide the switch if necessary.

! **Note:** Some computers do not have the voltage switch. These computers automatically control the voltage.

- If the voltage supply range is 100-127 V ac, set the switch to 115 V.
- If the voltage supply range is 200-240 V ac, set the switch to 230 V.

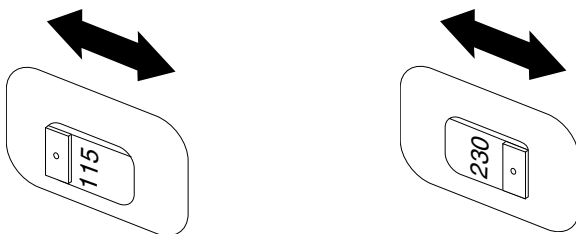

1.3.2 Connect the keyboard cable to the appropriate keyboard connector. (PS/2 connector or USB connector)

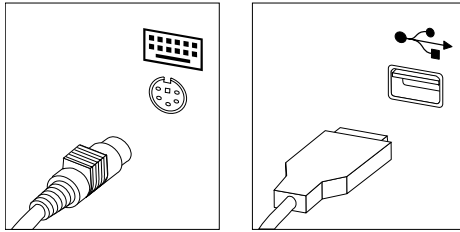

1.3.3 Connect the mouse cable to the appropriate mouse connector. (PS/2 connector or USB connector)

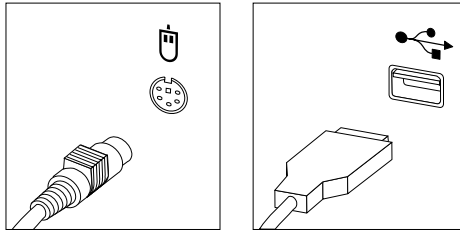

 **Note:** If your computer is equipped with a wireless keyboard or mouse, follow those installation instructions.

1.3.4 Connect the monitor cable to the monitor connector on the computer.

- If you have a Video Graphics Array (VGA) Standard monitor, connect the cable to the connector as shown.

 **Note:** If your model has two monitor connectors, be sure to use the connector on the graphics adapter.

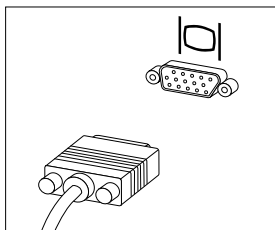

- If you have an HDMI monitor, your computer must have an adapter installed that supports the HDMI monitor. Connect the cable to the port as shown.

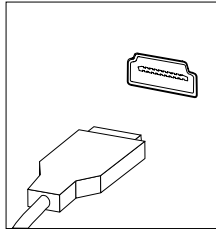

1.3.5 If you have audio devices, attach them using the following instructions.

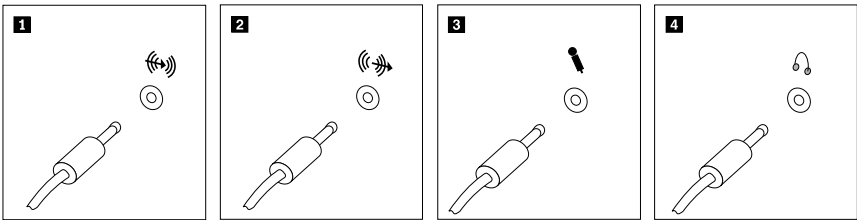

- 1 Audio line-in** This connector receives audio signals from an external audio device, such as a stereo system.
- 2 Audio line-out** This connector sends audio signals from the computer to external devices, such as powered stereo speakers.
- 3 Microphone** Use this connector to attach a microphone to your computer when you want to record sound or if you use speech-recognition software. This connector might be located on the front of the computer.
- 4 Headphone** Use this connector to attach headphones to your computer when you want to listen to music or other sounds without disturbing anyone. This connector might be located on the front of the computer.

1.3.6 Audio configuration instruction: (This instruction is only for PC models whose mainboard supports audio transforming from 2.0 stereo to 5.1 surround.)

This model of computer supports transforming stereo sound into 5.1 surround sound.

Use the following guides when connecting to the 5.1 surround audio device:

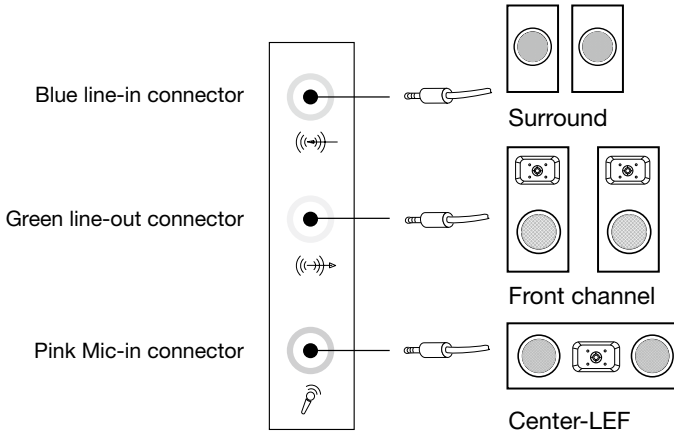

The configurations are as follows:

1. Right click the sound icon in system property bar and select the sounds option to setup the sounds in the pop-up dialog box.
2. Select a playback device from the playback dialog box, and then click the configure button to configure it.
3. Select 5.1 surround from audio channels in the pop-up speaker setup dialog box to proceed with the speaker setup by following as prompted.
4. After the configuration, 5.1 surround can be used.

⚠ Note: If the audio configuration interfaces in above differ from your actual computer, you may use the above steps as reference to configure the 5.1 surround audio device in your actual audio configuration interface and read the electronic help information for further assistance.

1.3.7 If you have powered speakers with an adapter:

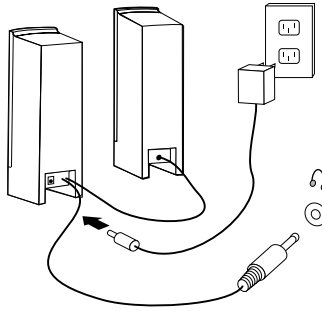

(This picture is only a sketch print, it does not show the actual figure of the speaker.)

- Connect the cable that runs between the speakers, if necessary. On some speakers, this cable is permanently attached.
- Connect the adapter cable to the speaker, if necessary. On some speakers, this cable is permanently attached.
- Connect the speakers to audio line-out port on the computer.
- Connect the adapter to the power source.

1.3.8 If you have *powered* speakers without an adapter:

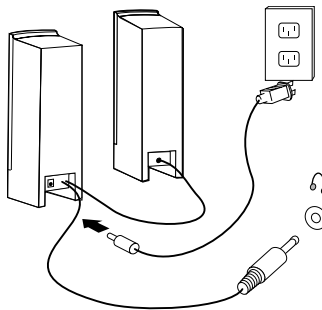

(This picture is only a sketch print, it does not show the actual figure of the speaker.)

- Connect the cable that runs between the speakers, if necessary. On some speakers, this cable is permanently attached.
- Connect the cable to the speaker, if necessary. On some speakers, this cable is permanently attached.
- Connect the speakers to audio line-out port on the computer.
- Connect the plug to the power source.

! **Note:** Some models are not equipped with external speaker.

1.3.9 Connect any additional devices that you have. Your computer might not have all connectors that are shown.

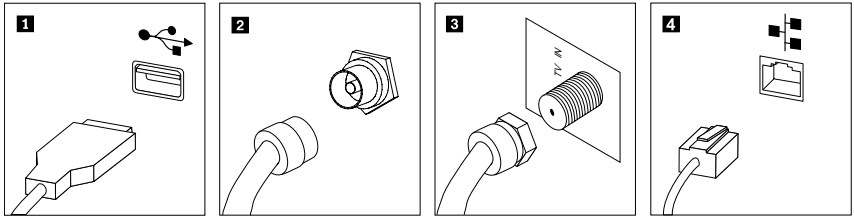

- 1 USB connector** Use this connector to attach a device that requires a USB connection.
- 2 TV-Tuner connector (IEC type)** Only supported on systems with optional TV tuner card (Some models are equipped with this connector).
- 3 TV antenna connector (F type)** To connect the signal input cable for CATV (Some models are equipped with this connector).
- 4 Ethernet** Use this connector to attach the computer to an Ethernet-type local area network.

1.3.10 Connect the power cords properly to ground electrical outlets.

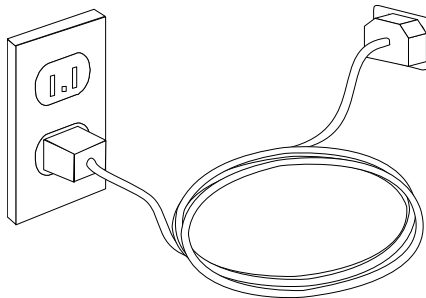

1.3.11 If your computer is equipped with Memory Card Reader Connector, it is able to read/write data from

- SD, SDHC;
- MS, MS pro;
- MMC, MMC plus.

1.3.12 Wired keyboard (Selected models only)

PS/2 keyboard

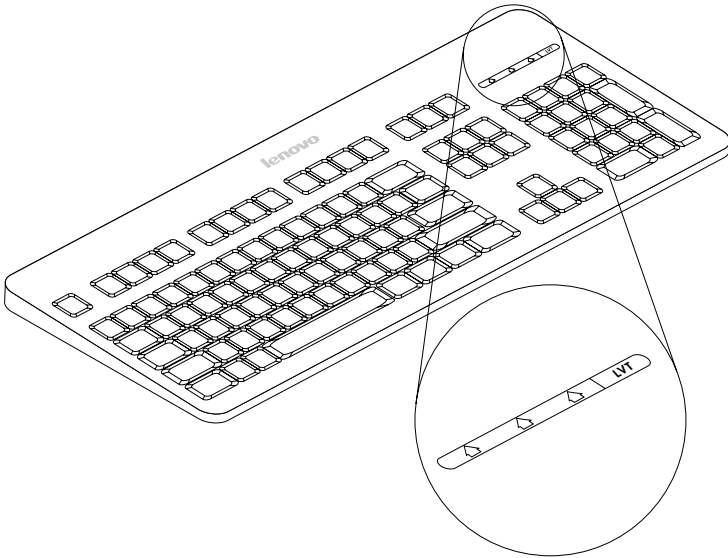

USB keyboard

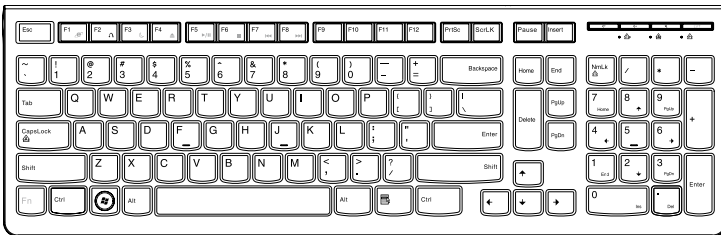

LVT — After entering Windows, press this key to launch the LVT (Lenovo Vantage Technology) program, Lenovo's pre-loaded Home PC software. In addition to its own functions, the LVT program will allow you to start other Windows compatible software, specially configured to run on this model of computer.

F2 — Your computer has the Lenovo Rescue System installed. To learn more about this program, repeatedly press and release the F2 key once turning on the computer until the Lenovo Rescue System open.

2

Chapter

Using the Rescue System

This chapter contains the following topics:

- OneKey Recovery
- Driver and Application Installation
- System Setup
- System Backup
- System Recovery
- Create Recovery Disc



Attention: Using this program will result in loss of data.

- You can restore the C: drive of the computer to factory default settings or to the last system backup status using **OneKey Recovery**. If you do this, all of the existing data on drive C: will be lost, but the content and format of the other partitions of the hard disk drive will remain unchanged.
- If you want to install an operating system and back it up with **OneKey Recovery**, you must format the C: partition in **NTFS** format and install the operating system on the C: partition. Otherwise, the **OneKey Recovery** system cannot run.

1

2

3

4

Note about the service partition:

The files and relevant data used by the rescue system are saved in the service partition. Deleting this partition will make the rescue system unusable. For more detailed information, see the following instructions:

By selecting **Control Panel** → **Administrative Tools** → **Computer Management** → **Disk Management**, you can see the service partition, which must not be deleted.

 **Note:** The recovery files and relevant data used by the rescue system are saved in the service partition. If the service partition is deleted or damaged by someone other than authorized Lenovo service personnel, Lenovo will not be liable for any losses arising therefrom in any way.

2.1 OneKey Recovery

OneKey Recovery is an easy-to-use application. You can use it to restore your computer to the system default or to a previously backed up state.

Detailed Operation Procedure

1. Repeatedly press and release the **F2** key once turning on the computer until the **Lenovo Rescue System** open, then select **OneKey Recovery**.

 **Note:** System Recovery will overwrite all of the data on the C: drive. To prevent loss of data, be sure to back up relevant data before performing system recovery.

2. Follow the on-screen instructions to select the backup task you want to restore from and the disk where you want to install the operating system, then press **Next** to start the restore.
3. Please wait during the process of system recovery. Do not interrupt the operation during the recovery process.
4. After the system is recovered successfully, the software will prompt you to restart the computer. Restart the computer and start the operating system.

2.2 Driver and Application Installation

The **Driver and Application Installation** function in the rescue system provides a way for the user to conveniently reinstall all of the Lenovo applications and drivers that were shipped with your Lenovo hardware.

Method 1: Automatic Installation

Repeatedly press and release the **F2** key once turning on the computer until the **Lenovo Rescue System** open, then select **Drivers and Application Installation**.

Follow the on-screen prompts to install the Lenovo drivers and applications. Click **Install** to start installing the **Lenovo Drivers and Application Installation** software.

The system will restart. After the system has restarted, the installation process will continue until it has completed.

Method 2: Manual Installation

In the Windows system, Click **Start** → **All Programs** → **Lenovo** → **Lenovo Drivers and Application Installation**.

After starting the procedure, install all the drivers and software manually by following the prompts.

Notes:

1. Do not install software which is already installed on the computer.
2. Make sure that the Drivers and Application Installation software has been automatically installed before starting the operating system. The manual installation function can only be used after the software has been installed.

2.3 System Setup

System Setup configures the network configuration for the Lenovo Rescue System to ensure your Rescue System can connect to internet. In addition, System Setup sets and manages all passwords for the Lenovo Rescue system.

2.3.1 Launch

Repeatedly press and release the **F2** key once turning on the computer until the **Lenovo Rescue System** open, then select **System Setup**.

2.3.2 Network Settings

Depending on the network access mode of the computer, select “ADSL” or “LAN Connection” in the network connection modes.

1. If you select “ADSL” input the username and password of the ADSL connection.

2. If you select “LAN connection” configure the IP address and proxy server of the LAN.

2.3.3 Password Management

Password Management allows you to set and manage the password for Lenovo Rescue System.

The default password is blank.

Set a password when you access **Password Management** for the first time. If you don't want to set a password, access the system directly and operate it accordingly.

2.4 System Backup

This backs up your system partition to an image file. In case of a system failure, you can restore your system from this image file.

In the Windows system, click **Start** → **All Programs** → **Lenovo** → **Lenovo Rescue System**.

After starting Rescue System, click **System Backup** to back up your system partition by following the prompts.

2.5 System Recovery

Reboot your computer into the system recovery environment. You can choose to restore to a system backup point or the initial state (factory default settings).

2.6 Create Recovery Disc

Create a bootable recovery disc from the current system. These recovery discs are used to boot your computer and will guide you through the entire restoration process.

In the Windows system, click **Start** → **All Programs** → **Lenovo** → **Lenovo Rescue System**.

After starting Rescue System, click **Create Recovery Disc** to create a bootable recovery disc from the current system.

Follow the on-screen prompts to create recovery discs.

3

Chapter

Using the Computer Software

This chapter contains the following topics:

- Lenovo Dynamic Brightness system
- Lenovo Eye Distance System

! **Note:** The interface and function of each of these features are subject to the actual software that was shipped with the computer model that you purchased.

1

2

3

4

3.1 Lenovo Dynamic Brightness system

Lenovo Dynamic Brightness System can automatically detect the surrounding ambient brightness and will adjust display brightness accordingly. You can set the screen brightness to a comfortable level for different environments. You can also set the display delay time to automatically turn off the display when you are away from the computer.

! **Note:** The Auto Switch Display function can not be used when your computer is in standby mode, sleep mode or turned off.

! **Note:** This function applies only to the computer equipped with a Lenovo PC camera and is available only after the camera is installed.

Before using this software, do the following:

1) Click **Start** → **All Programs** → **Lenovo USB2.0 UVC Camera** → **vmcap**.

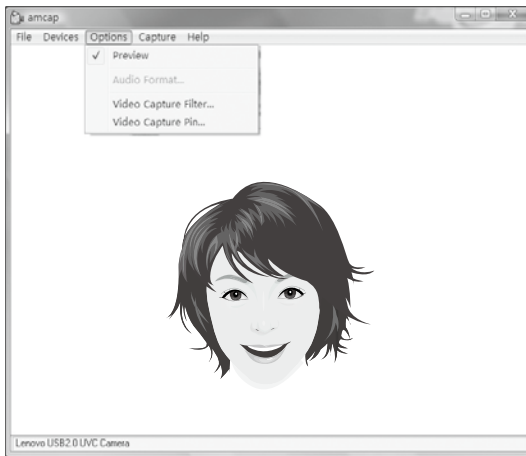

2) Select **Options** → **Preview** from the pop-up window to display the image in the video capture window.

! **Note:** If there is no image display in the AMCAP video capture window, please confirm that preview in the options has been checked.

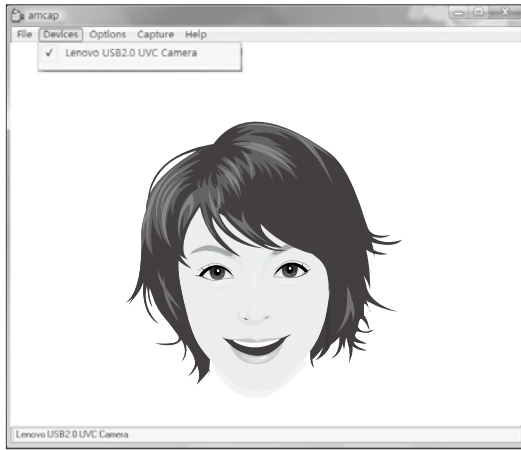

- 3) Confirm that **Devices** → **Lenovo USB 2.0 UVC Camera** has been checked. If there are other devices in this option, do not check them. Only choose the “**Lenovo USB 2.0 UVC Camera**” device, and the window should display the camera image. An image, which is caught by Lenovo PC camera, will be displayed in the video capture window. Adjust the position and pitch angle of the camera to ensure the whole face is displayed in the video capture window.

To use this software, do the following:

Click **Start** → **All Programs** → **Lenovo** → **Lenovo Dynamic Brightness system**.

The default setting has been pre-selected. You can adjust the brightness and display delay time according to your needs.

3.2 Lenovo Eye Distance System

Lenovo Eye Distance System can automatically detect the distance between you and the display. It will alert you automatically when you sit too close to the display. You can also set viewing distance as well as the time interval beyond which a warning will pop up.

! **Note:** This function applies only to the computer equipped with a Lenovo PC camera and is available only after the camera is installed.

To use this software, do the following:

Click **Start** → **All Programs** → **Lenovo** → **Lenovo Eye Distance System**.

The default setting has been pre-selected. You can adjust the viewing distance according to your needs.

 **Notes:**

1. Ensure the lens of the camera is exposed and not covered.
2. Ensure your eyes are exposed and not covered.

(The function that detects the distance between the user and monitor is based on the position of the user's eyes. Therefore, if the eyes are covered or there is a strong reflection, the distance detection may be affected.)

Wear glasses may affect the accuracy of the face image verification.

3. The limitation of the distance detection by the camera:

The minimum distance: about 20 centimeters (7.90 inches)

The maximum distance: about 70 centimeters (27.55 inches)

The pitch angle (the face rotary angle scope in the vertical):

Elevation angle: 20 degrees

Depression angle: 30 degrees

The horizontal rotary angle (the face rotary angle scope in the horizontal): -20 ~ +20 degrees

4

Chapter

Troubleshooting and Confirming Setup

This chapter contains the following topics:

- Troubleshooting and Problem Resolution

 **Note:** The description of the TV-Tuner card in this manual is only used for the machines which have the TV-Tuner card. It does not apply to those machines that do not have a TV-Tuner card.

1

2

3

4

Solving Problems

Follow these tips when you troubleshoot your computer:

- If you added or removed a part before the problem started, review the installation procedures and ensure that the part is correctly installed.
- If a peripheral device does not work, ensure that the device is properly connected.
- If an error message appears on the screen, write down the exact message. This message may help support personnel diagnose and fix the problem(s).
- If an error message occurs in a program, see the program's documentation.

 **Note:** The procedures in this document were written for the Windows default view, so they may not apply if you set your Lenovo® computer to the Windows Classic view.

4.1 Troubleshooting Display Problems

Problem: Blank screen or no image is displayed on the monitor.

Troubleshooting and problem resolution:

1. Check that the monitor has been turned on; if not, press the Power button.
2. Check to see if the monitor power cord is loose; if so, securely plug the power cord to the monitor.
3. Check that the signal cable to the monitor is securely connected to the connector on the computer graphics card; if not, shut down the computer then securely connect the signal cable of the monitor.

Problem: You need to change display property settings.

Setting display background and icon properties:

1. Right-click the desktop anywhere except over an icon, then select Personalize from the pop-up menu.
2. From here, select the appropriate options to:
 - Change the desktop background
 - Select a screen saver
 - Select colors and appearance options for icons and characters
 - Set resolution and colors by using Display Settings options

Problem: Ripple on screen

Troubleshooting and problem resolution:

1. Check for devices located less than one meter from the computer such as refrigerators, electric fans, electric dryers, UPSs, regulators, fluorescent lamps or other computers that may be generating magnetic interference.
2. Move any interfering devices away from the computer.
3. If the problem persists, consult with Lenovo Service.

4.2 Troubleshooting Audio Problems

Problem: No sound from integrated speakers.

Troubleshooting and problem resolution:

- Adjust the windows volume control — Double-click the speaker icon in the lower-right corner of your screen. Ensure that the volume is turned up and that the sound is not muted. Adjust the volume, bass, or treble controls to eliminate distortion.
- Reinstall the audio driver.
- Disconnect headphones from the headphone connector — Sound from the speakers is automatically disabled when headphones are connected to the computer's side-panel headphone connector.

Problem: No sound from headphones.

Troubleshooting and problem resolution:

- Check the headphone cable connection — Ensure that the headphone cable is securely inserted into the headphone connector.
- Adjust the windows volume control — Click or double-click the speaker icon in the lower-right corner of your screen. Ensure that the volume is turned up and that the sound is not muted.

4.3 Troubleshooting Software Problems

Problem: You are unable exit a running program normally.

Troubleshooting and problem resolution:

1. Open the **Task Manager** window by pressing **Ctrl, Alt** and **Delete** at the same time.
2. Select the **Application** tab, select the problem program, and then click the **End Task** button.

Problem: You need to install or uninstall a program.

Problem resolution:

During installation never abort the install process by powering the system off or through other drastic means. This can cause system program disorder or even failure during system initialization.

During the uninstall process, never directly delete the files or folders. This is harmful to the system, and might cause a system-wide malfunction.

Use the following procedure to properly uninstall programs:

1. Back up all documents and system settings related to the program before removing it.
2. If the program has its own uninstaller, run it directly to uninstall the program.
3. If the program does not have its own uninstaller, then select Control Panel from Start menu.
4. From the Control Panel, choose Programs and Functions.
5. Find the applicable program from the Programs and Functions dialog box and then select Uninstall/Modify.
6. Perform the instructions displayed to uninstall the software.

4.4 Troubleshooting Problems with Optical Drives and Hard Disks

Problem: The Optical drive is unable to read a CD/DVD.

Troubleshooting and problem resolution:

1. Check to determine if there is an optical drive icon in the resource manager of the operating system. If not, restart your computer. If there is still no icon, contact Lenovo Service. Otherwise, continue with the next step of this procedure.
2. Confirm that the CD/DVD has been properly placed in the drive. If not, reload the CD or DVD. Otherwise, continue with the next step of this procedure.
3. Check the specifications that came with your computer to confirm that this optical drive is supposed to be able to read this type of CD or DVD.
4. If the CD/DVD cannot be read, replace it with a known good CD/DVD such as one that was shipped with the computer.
5. If the known good CD cannot be read, visually check the operating side of the CD/DVD for defects.

Problem: The capacity of the hard disk, as indicated by the system, is less than the nominal capacity.

Troubleshooting and problem resolution: For computers equipped with the OneKey Recovery feature, the system recovery feature needs to occupy some hard disk space. This may account for the apparent hard disk capacity deficit.

Further Technical Explanation: The nominal capacity of the hard disk is expressed in the decimal system, 1000 bytes. But the actual hard disk capacity is expressed in the binary system as 1024 bytes (For example, the nominal capacity 1G is 1000M, while the actual capacity 1G is 1024M).

The capacity of the hard disk shown in Windows can be calculated according to the calculations in the following example:

The nominal capacity of the hard disk is 40G, while its actual capacity should be: $40 \times 1000 \times 1000 \times 1000 / (1024 \times 1024 \times 1024) = 37\text{G}$.

If the Service partition of 3G - $3 \times 1000 \times 1000 \times 1000 / (1024 \times 1024 \times 1024) = 2.79\text{G}$ is subtracted, the capacity of the hard disk shown in the system can be obtained.

The capacity of the hard disk as calculated using this method may be slightly different from the actual capacity due to the rounding of totals.

4.5 Special considerations for troubleshooting Windows

Record the following information that may later be useful in troubleshooting system problems:

1. The serial number of the software. The serial number was shipped with the computer and was provided separately by the manufacturer. The Help Center is unable to retrieve this number.
2. The drivers for this computer model only support the Windows 7 system.
3. When you use the Windows Media Center to watch TV, be particularly attentive to the following:
 - In the following two situations, you must re-save a channel list:
 - a. When you change your TV signal from digital to analog, your saved channel list for digital TV is deleted. When you want to watch digital TV again, you must create and save a new channel list.
 - b. When you change your TV signal from analog to digital, your saved channel list for analog TV is deleted. When you want to watch analog TV again, you must create and save a new channel list.

- Before you can watch teletext programming, you must set the TV tuner input signal to analog.

4.6 Performing Daily Maintenance Tasks

Cleaning the computer components

Because many of the computer components consist of sophisticated integrated circuit boards, it is very important to periodically clean around the computer to prevent dust buildup. The cleaning supplies you need in order to clean the components include: a vacuum cleaner, a soft cotton cloth, clear water (pure water preferred) and cotton swabs.



Attention: Before you clean your computer, disconnect the computer from the electrical outlet. Clean your computer with a soft cloth dampened with water. Do not use liquid or aerosol cleaners, which may contain flammable substances.



Note: To avoid damaging the computer or display, do not spray cleaning solution directly onto the display. Only use products specifically designed for cleaning displays, and follow the instructions that are included with the product.

The following are general methods for cleaning the components:

- You can use a soft cloth to remove dust on the surface of the computer, the monitor, the printer, the speakers and the mouse.
- You can use a vacuum cleaner to clean in otherwise inaccessible corners.
- To clean the keyboard thoroughly, shut down the computer and scrub it gently with a wet cloth.
- Do *not* use the keyboard until it is dry.

Do not do any of the following:

- Allow water to enter the computer
- Use a heavily dampened cloth
- Spray water directly onto the surface of the monitor or inside of computer.

Daily attention should be given to LCD monitors. Use a dry cloth daily to brush dust from the monitor and keyboard. Keep all surfaces clean and free of grease stains.

Free Manuals Download Website

<http://myh66.com>

<http://usermanuals.us>

<http://www.somanuals.com>

<http://www.4manuals.cc>

<http://www.manual-lib.com>

<http://www.404manual.com>

<http://www.luxmanual.com>

<http://aubethermostatmanual.com>

Golf course search by state

<http://golfingnear.com>

Email search by domain

<http://emailbydomain.com>

Auto manuals search

<http://auto.somanuals.com>

TV manuals search

<http://tv.somanuals.com>