

Machine type: 10097/2566 [B340]
10099/2568 [B540]
10101/3363 [B540p]
10098/2567 [B345]
10100/4749 [B545]

Lenovo

IdeaCentre B3/B5 Series

User Guide

Version 2.0 2012.08

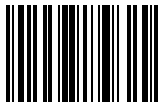

31502494



lenovo

ideacentre

Important Safety Information

Before using this manual, it is important that you read and understand all of the related safety information for this product. Refer to the *Safety and Warranty Guide* that you received with this product for the latest safety information. Reading and understanding this safety information reduces the risk of personal injury or product damage.

The interface and functions shown in this User Guide are provided for reference only and may differ from actual product appearance. Product design and specifications may be changed without notice.



Danger: Be aware of extremely hazardous or potentially lethal situations.



Attention: Be aware of possible damage to programs, devices, or data.



Note: Pay attention to this important information.

© Copyright Lenovo 2012. All rights reserved.

LIMITED AND RESTRICTED RIGHTS NOTICE: If data or software is delivered pursuant a General Services Administration “GSA” contract, use, reproduction, or disclosure is subject to restrictions set forth in Contract No. GS-35F-05925.

Contents

Important Safety Information

Using the Computer Hardware	1
Front view of the computer.....	2
Left and right view of the computer	3
Rear view of the computer	4
TV button instructions (selected models only).....	5
Computer stand.....	6
Connecting your computer.....	7
Important information about using the computer	8
Wired keyboard (selected models only)	10
Connecting to the Internet.....	10
Using Windows 8.....	11
Switching between the main Windows 8 interfaces	12
The Charms Bar	12
Shutting down the computer	12
Switching between apps	12
Closing an app.....	13
Opening other system programs	13
Windows Help and Support	13
Touch screen instructions	15
Touch Screen Calibration.....	16
User Gesture Instructions for the Touch screen	16
Precautions when using the Touch Screen	21

Using the Onekey TV (selected models only)	23
Guide to the remote control (selected models only)	25
Onekey TV Instructions (ASTC model) (selected models only).....	28
Onekey TV Instructions (DVB-T model) (selected models only)	30
Onekey TV Instructions (ATV model) (selected models only).....	33
Using the Rescue System.....	35
OneKey Recovery	36
Driver and Application Installation	37
Troubleshooting and Confirming Setup	39
Troubleshooting Display Problems	40
Troubleshooting Touch screen	41
Troubleshooting Audio Problems	41
Troubleshooting Software Problems	42
Troubleshooting Problems with Optical Drives and Hard Disks	43
Special considerations for troubleshooting Windows	44
Windows Help and Support	44
BIOS setup utility	45
Performing Daily Maintenance Tasks	46
Hardware Replacement Guide	47
Overview	48
Replacing hardware	51
Appendix.	62
Declaration.....	62
Trademarks	63
Energy Star Statement	64
Enabling ErP compliance mode.....	65

Using the Computer Hardware

This chapter contains the following topics:

- Introduction to the computer hardware
- Information on computer connections

 **Note:** The descriptions in this chapter might be different from what you see on your computer, depending on the computer model and configuration.

Front view of the computer



Attention: Be careful not to block any air vents on the computer. Blocked air vents can cause overheating.

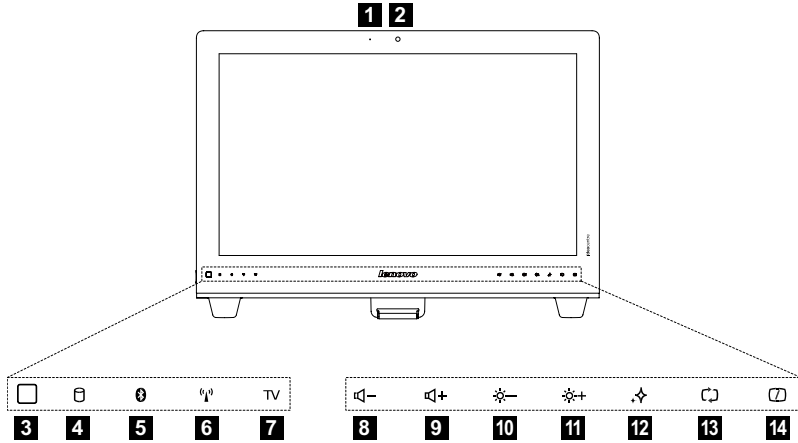

- | | |
|--|------------------------------------|
| 1 Built-in microphone area | 2 Camera |
| 3 Built-in IR Emitter (do not block) (selected models only) | 4 Hard Disk Drive Indicator |
| 5 Bluetooth status indicator | 6 WIFI status indicator |
| 7 TV indicator | 8 Volume down |
| 9 Volume up | 10 Brightness down |
| 11 Brightness up | 12 Novo Vision button |
| 13 PC mode / HDMI-in / AV-in switch | 14 Monitor On/Off |



Attention: The effective range of the Built-in IR Emitter is 10 feet (3m).

Left and right view of the computer

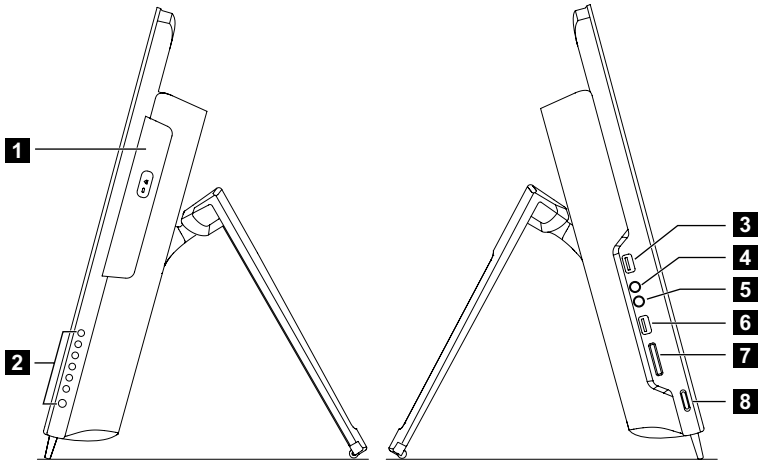

- 1** Optical drive
- 2** TV buttons (selected models only)
- 3** USB connector
- 4** Headphone port
- 5** Microphone port
- 6** USB connector
- 7** Memory card reader
- 8** Power button

Rear view of the computer

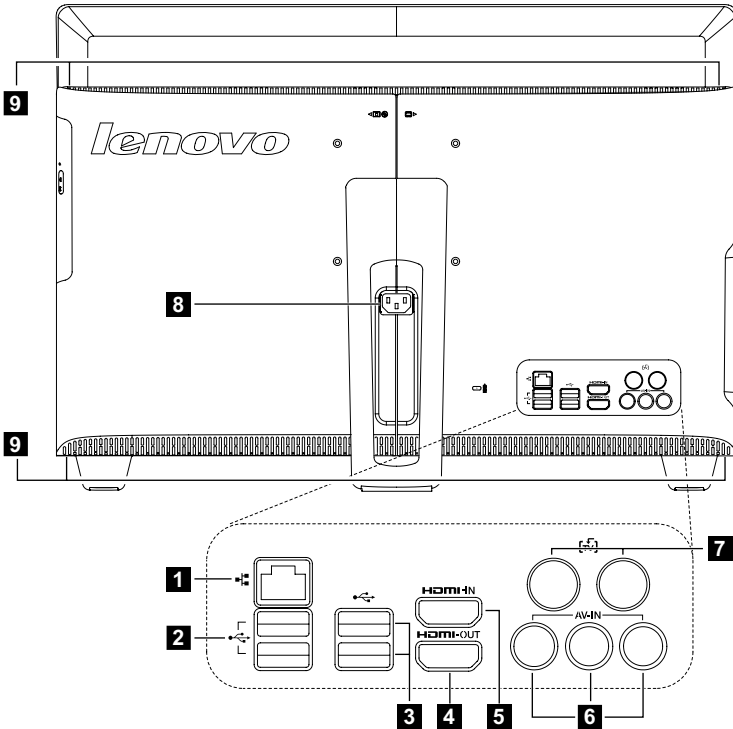

- 1** Ethernet port
- 2** USB 2.0 connectors
- 3** USB 3.0 connectors (selected models only)
- 4** HDMI-out connector
- 5** HDMI-in connector (selected models only)
- 6** AV-IN connectors (selected models only)
- 7** TV tuner ports (selected models only)
- 8** Power connector
- 9** Air vents (do not block)

TV button instructions (selected models only)

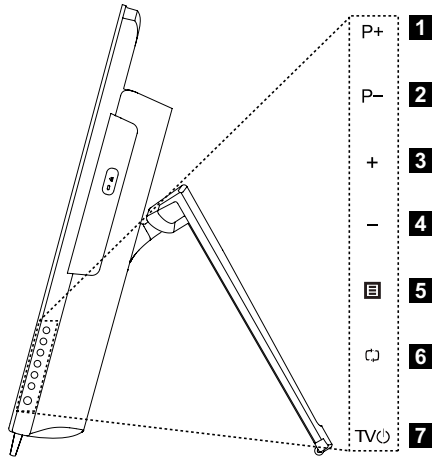

- 1** Channel up
- 2** Channel down
- 3** Volume up
- 4** Volume down
- 5** TV mode menu button
- 6** Signal source selection button
- 7** TV power On/Off

Computer stand

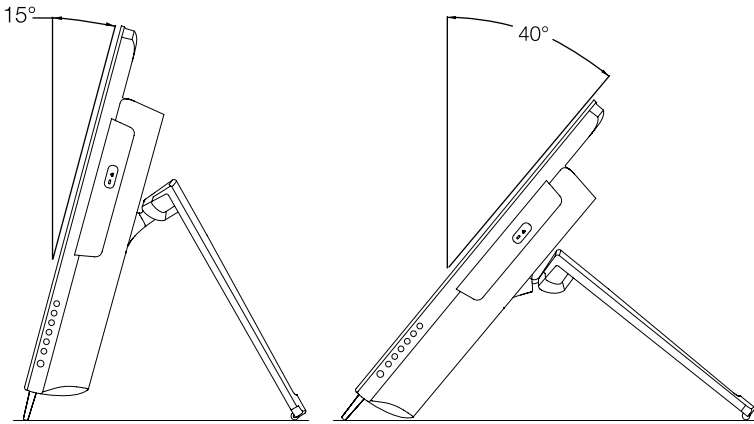

Use the stand to position the display to your preference. It can be rotated between 15° and 40° from the vertical.



Attention:

1. The computer stand must remain installed at all times to ensure maximum system stability.
2. Make sure the angle of the computer is at least 15 degrees from the vertical; otherwise the computer will be unstable and could fall over.

Connecting your computer

 **Note:** Your computer may not have all of the connectors described in this section.

Basic connector instructions

Connector	Description
Microphone	Use this connector to attach a microphone to your computer when you want to record sound or if you use speech-recognition software.
Headphone	Use this connector to attach headphones to your computer when you want to listen to music or other sounds without disturbing anyone.
USB connector	Use this connector to attach a device that requires a USB connection.
Ethernet connector	Use this connector to attach the computer to an Ethernet-type local area network.
HDMI connector (optional)	Connects to the HDMI connector on your display or TV.
TV-Tuner connector (optional)	Connects to an external antenna to view programs using the optional TV tuner card.
AV-in connector (optional)	Connects to the composite audio and video connectors on your video device.

 **Note:** If your computer is equipped with a wireless keyboard or mouse, follow the installation instructions for those devices.

Connecting the power cord

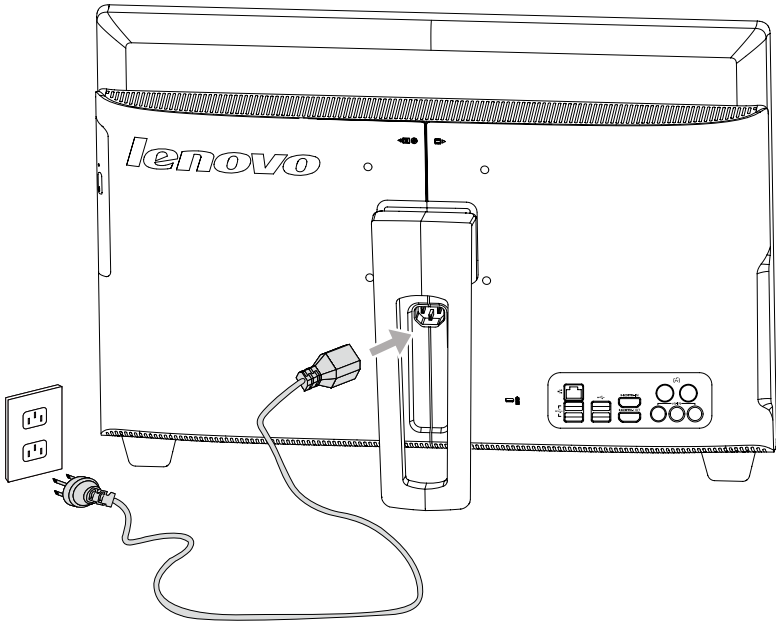

Important information about using the computer

Press the power button on the side of the computer to turn on the computer.

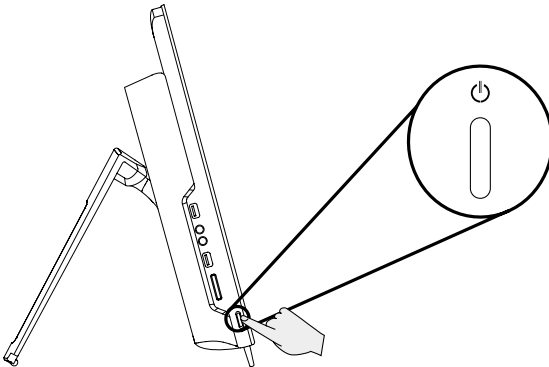

! **Note:** The buttons at the bottom of the screen are touch buttons. When you touch these, the indicator lights turn on.

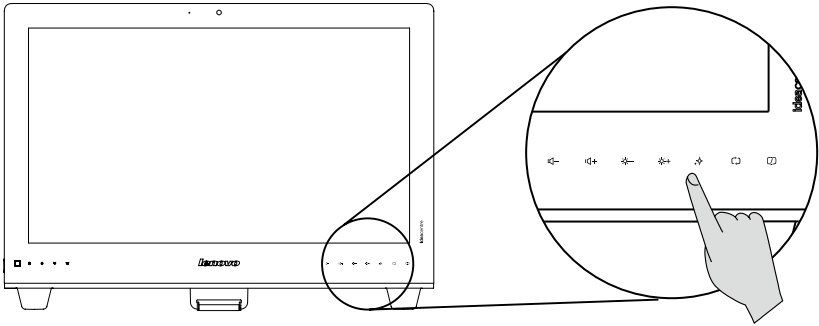

Hold the computer tightly when you carry it.

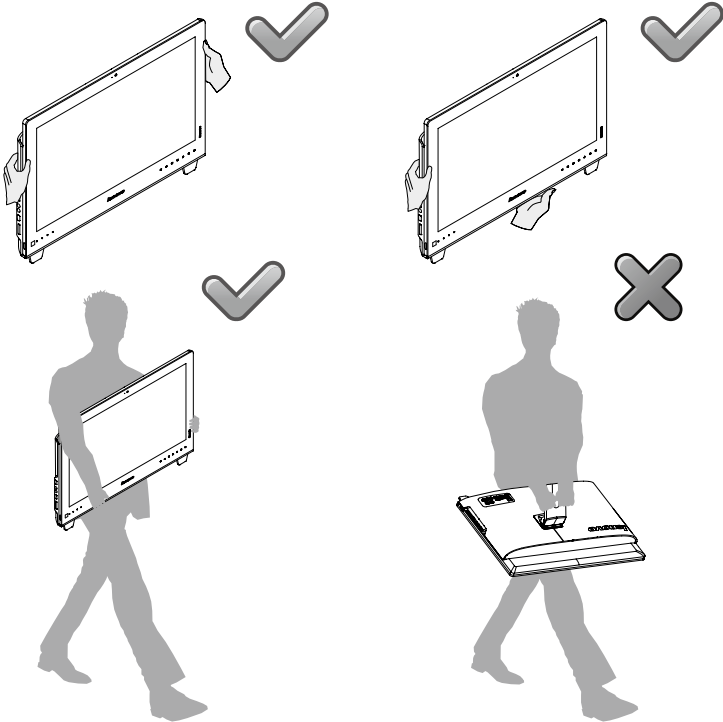

Wired keyboard (selected models only)

LVT — After entering Windows, press this key to launch the LVT (Lenovo Vantage Technology) program, Lenovo's pre-loaded Home PC software. In addition to its own functions, the LVT program will allow you to start other Windows compatible software, specially configured to run on this model of computer.

F2 — Your computer has the Lenovo Rescue System installed. To learn more about this program, repeatedly press and release the F2 key once turning on the computer until the Lenovo Rescue System open.

Connecting to the Internet

To connect to the Internet, you'll need a contract with an Internet Service Provider (ISP) and some hardware.

IPs and ISP offerings vary by country. Contact your ISP for offerings available in your country.

Your computer is designed to support a wireless (selected models only) or wired network that connects your computer to other devices.

Wired network connection

For wired networks, connect one end of an Ethernet cable (purchased separately) to the Ethernet connector on your computer, and then connect the other end to the network router or broadband modem. Consult your ISP for detailed setup instructions.

 **Note:** Broadband modem and router installation procedures vary depending on the manufacturer. Follow the manufacturer's instructions.

Wireless network connection

For wireless networks, you can use the built-in wireless LAN antenna to access your wireless home network.

To connect your computer to the wireless network:

1. Swipe in from the right edge of the screen, then tap **Settings**.
(If you are using a mouse, point to the top right or bottom right corner of the screen, then click **Settings**.)
2. Tap or click the network icon , then select the name of your router. Tap or click **Connect**, then follow the steps on the screen.

Test the wireless network by opening your Web browser and accessing any Web site.

Using Windows 8

This chapter contains the following topics:

- Switching between the main Windows 8 interfaces
- The Charms Bar
- Shutting down the computer
- Switching between apps
- Closing an app
- Opening other system programs
- Windows Help and Support



Attention: The Windows 8 operating system is provided by Microsoft Corporation. Please use it in accordance with the End User License Agreement (EULA) between you and Microsoft. For any question related to the operating system, please contact Microsoft directly.

Switching between the main Windows 8 interfaces

Windows 8 comes with two main user interfaces: the Start Screen and the Windows desktop.

To switch from the Start Screen to the Windows desktop, do one of the following:

- Select the Windows desktop tile on the Start Screen.
- Press the Windows key  + D.

To switch from the desktop to the Start Screen, do one of the following:

- Select **Start** from the Charms Bar.
- Move the cursor to the bottom left corner, then select the Start Screen thumbnail when it is displayed.
- Press the Windows key .

The Charms Bar

Charms provide new and faster ways to perform many basic tasks.

To display the charms, do one of the following:

- Swipe in from the right edge of the screen.
- If you are using a mouse, point to the top right or bottom right corner of the screen.
- Press the Windows key  + C.

Shutting down the computer

To shut down the computer:

1. Swipe in from the right edge of the screen, then tap **Settings**. (If you are using a mouse, point to the top right or bottom right corner of the screen, then click **Settings**.)
2. Select **Power** → **Shutdown**.

Switching between apps

Sometimes you want to get back to an app you were just using, or quickly switch through your recent apps.

To switch between apps:

Swipe in from the left edge of the screen or move the cursor to the top left corner, then click to bring in the next app.

Closing an app

To close an app, do one of the following:

- Move the cursor to the top left corner of the screen. When the thumbnail appears, drag it to the bottom of the screen.
- Swipe in from the top edge of the screen. When the app page becomes smaller, drag it to the bottom of the screen.
- Move the cursor to the top edge of the screen. When the cursor becomes a hand, drag the app page to the bottom of the screen.

Opening other system programs

There is a fast way to open other system programs.

To open the menu, do one of the following:

- Move the cursor to the bottom left corner of the screen. When the thumbnail appears, right-click with the mouse to open the menu.
- Press the Windows key  + X.

Windows Help and Support

If you have a problem with the operating system, see the Windows Help and Support file. To open the Windows Help and Support file, do one of the following:

- Select the **Settings** charm, then select **Help**.
- Press the Windows key  + F1.

You can read the Windows Help and Support file on your computer. You can also get online help and support by clicking on one of the two links listed under **More to explore**.

Touch screen instructions

A graphic of a spiral-bound notebook with a white cover and a grey spiral binding on the left side. The notebook is open to a page with a white background and a thin black border. The text is centered on the page.

This chapter contains the following topics:

- Touch Screen Calibration
- User Gesture Instructions for the Touch screen
- Attentions when using the Touch Screen

The monitor is touch-sensitive thanks to its touch-sensitive screen. A touch screen is an input device just like a mouse or a keyboard, and the user's fingers transmit position information via the touch screen to the computer. With this technology, you only need to touch the pictures or words on the computer display lightly with your finger, and the computer will react.

Touch Screen Calibration

Prior to first use or whenever the touch screen reacts in a different place where you are touching it, start the calibration program. The procedure is as follows:

1. In Control Panel, select "Hardware and Sound".
2. In "Hardware and Sound" window, select "Tablet PC Settings".
3. In "Tablet PC Settings" dialogue, click "Calibrate" button.

User Gesture Instructions for the Touch screen

The Touch screen supports single touch and rotational movements, enlargement and reduction multi-touch operations, and the user can transmit position information to the computer via touch. The touch screen uses a very low pressure movement recognition method, which only needs the finger to move lightly on the computer display screen or make a simple hand gesture to be detected by the main computer processor.

Basic Hand Gestures

1. Single Click / Double Click

For the item selected on the touch screen, with one finger touch it one or two times, to perform a single click or double click operation. This is similar to the action performed by clicking the mouse left button.

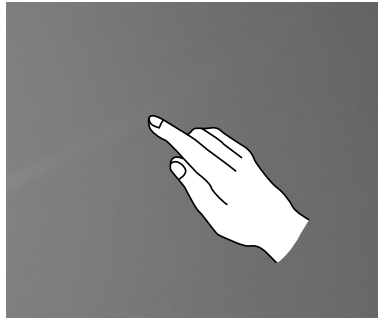

2. Single Finger Right Click

For the item selected on the touch screen, press and hold your finger on the screen until a circle appears. After lifting your finger from the touch screen, a menu bar will pop up, completing the single finger right click operation. This is similar to the action performed by clicking the mouse right button.

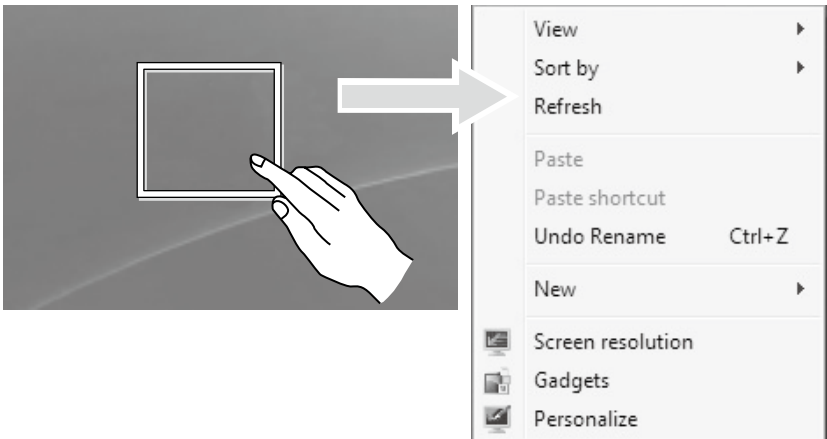

3. Dragging Movement

First touch your finger on the desired item on the screen and hold it there, then make a dragging movement. This is similar to the click and drag movement you can make with a mouse.

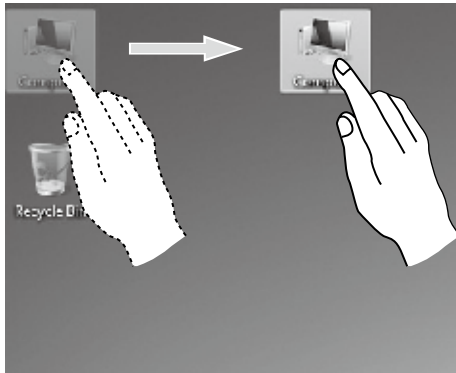

4. Rolling Movement

When you move your finger one time vertically (or horizontally) on the touch screen, this is called a Rolling Operation. For example: This operation is similar to moving the scroll wheel on the top of a mouse, and produces the same results as the scroll wheel interface does.



5. Zoom Operation

Touch two fingers lightly on the desired item on the touch screen, then keeping both fingers on the screen, change the distance between them. By increasing (or decreasing) the distance, you can perform a zoom in (or zoom out) operation. For example: you can enlarge or reduce the picture size in Windows Photo Viewer.

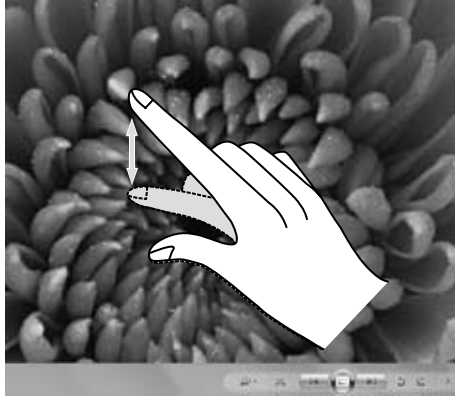

6. Rotation Operation

Use two figures to touch the desired item on the touch screen, then rotate them in the desired direction. For example: you can rotate the picture which is being displayed in Windows Photo Viewer.

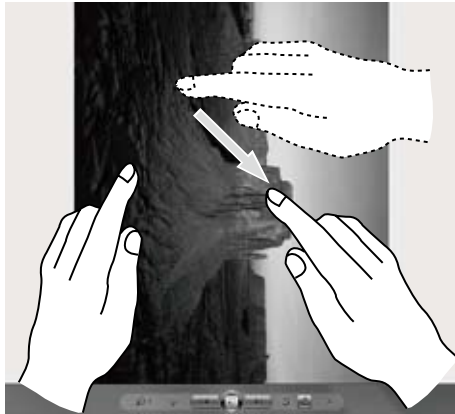

! **Note:** To learn more about how to use the touch screen, refer to **Windows Help and Support** by press Windows key  + F1 or Select **Settings** charm, then select **Help**.

Related Touch Screen Settings

- Select **Hardware and Sound** → **Pen and Touch** from the **Settings** charm.
- Select touch actions which you wish to adjust. By clicking on “**Settings**”, you can adjust the “**Speed**” and “**Spatial tolerance**” parameters, to match the user’s natural way of double-clicking. You can double-click on the lower right corner of the icon to test this.

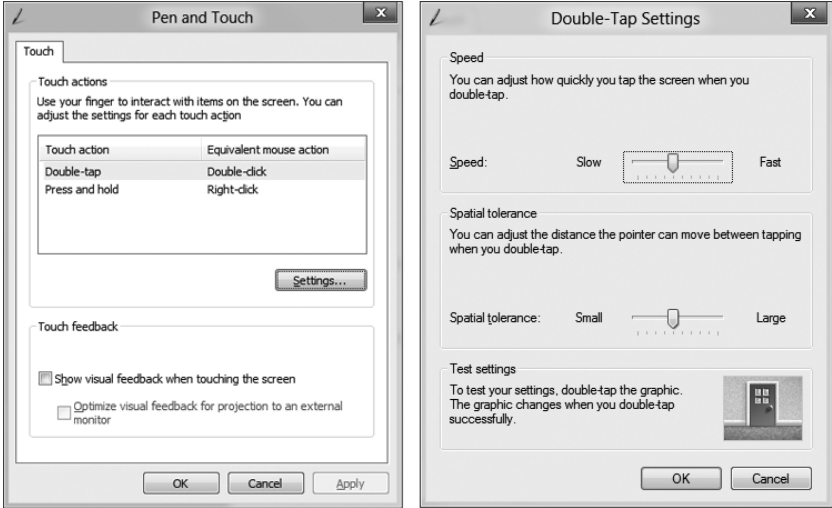

! **Note:** Users can access more help information from the **Windows Help and Support** menu.

Precautions when using the Touch Screen

1. When using the touch screen, be careful not to tear the surface with any sharp objects.

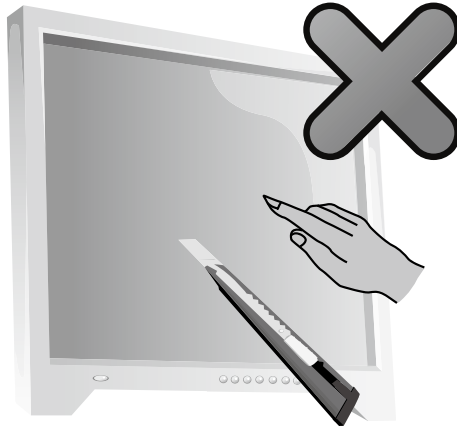

2. To ensure normal use of the touch screen, ensure that both the screen surface and your fingers are clean and dry.
3. To ensure precise positioning on the touch screen, avoid handling or touching the glass frame when you are touching the screen.
4. Turn the computer off for safety before cleaning the screen and frame with a soft cotton cloth. Do not wipe it with a wet cloth as this may leave a water mark and affect touch operation.
5. Avoid using the touch screen in dusty environments or hot or humid conditions. Any abrupt temperature change may cause condensation on the inside surface of the glass screen, which will disappear after a short time and does not affect normal use.

! **Note:** The touch screen will not affect other computer processes when used normally.

6. Recognition of touch gestures can be influenced by the following:
 - Touching the correct place on the screen.
 - The speed of movement.
 - The time interval from when the screen was last touched.

! **Note:** The user can consult this manual and also the related Windows help content to learn accurate hand gestures.

7. The touch screen does not function in Rescue System mode.
8. The touch screen also does not function during the startup process, in Hibernate mode and in Sleep mode or Safe mode.

Using the Onekey TV (selected models only)



This chapter contains the following topics:

- Guide to the remote control
- Onekey TV Instructions (ASTC model)
- Onekey TV Instructions (DVB-T model)
- Onekey TV Instructions (ATV model)

To turn on the Onekey TV

Press the power button on the side of the computer or remote control to turn on the TV.

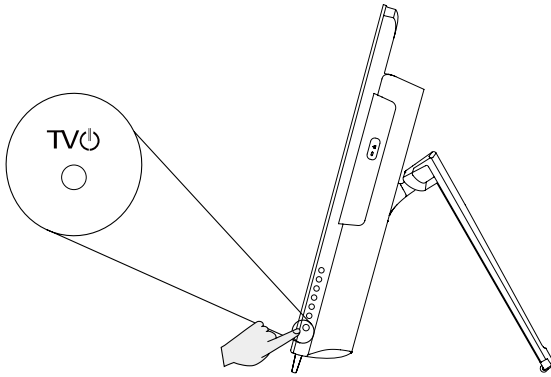

To turn on the computer

Press the power button on the side of the computer to turn on the computer.

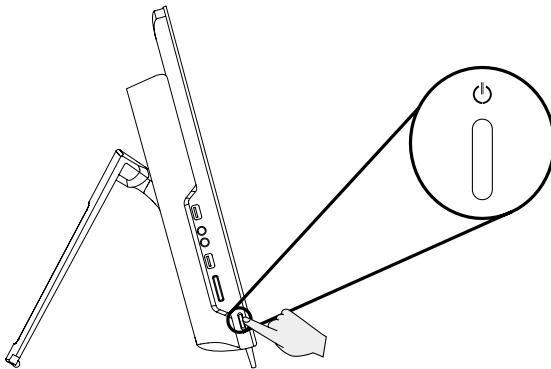







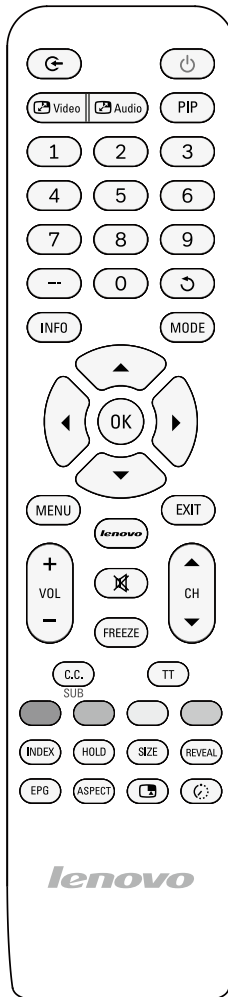











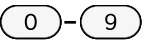









Guide to the remote control (selected models only)

! Notes:

1. The remote control can only turn on the Onekey TV, it cannot turn on the computer.
2. Use the remote control within 23 feet of the TV.
3. The color and shape may vary depending on the model.



Button	Description
	Display and select the available video sources.
	Turn the TV on and off.
	Alternate the video between the main picture and sub-picture.
	Alternate the audio between the main picture and sub-picture.
	Picture in Picture
	ATSC & ATV model: Press to select additional channels being broadcast by the same station. DVB-T model: Enter the password to access a channel locked by the Child Lock function.
	Return to the previous channel.
	Display information on the TV screen.
	Select the picture mode.
	Move the cursor to navigate and select options.
	Confirm a setting
	Press to directly access channels.
	Display the main on-screen menu.
	Return to the previous menu.
	Adjust the volume.
	Turn the TV sound off.
	Change channels.
	Freeze the screen.
	C.C. : Control the caption decoder. (ATSC) SUB : Display digital subtitles. (DVB-T) Not available on ATV models.

Button	Description	
	Teletext ON/OFF	<p>Note: These buttons are usable with TV Tuner cards installed and in countries that support Teletext functions only.</p>
	Press the colored buttons to operate the Teletext screen.	
	Press to return to the main index page.	
	Press to hold the Teletext page when viewing information. Press again to return to automatic page update.	
	Press repeatedly to display the upper part of the teletext screen, then the lower part, and then to return to full screen.	
	Press to reveal hidden words e.g. quiz page answers. Press again to hide.	
	Electronic Programme Guide. Not available on ATV models.	
	Change the screen size mode.	
	Change the video source of sub-picture.	
	Automatically shut off the TV at a preset time.	
	Not available on this model.	

Onekey TV Instructions (ASTC model) (selected models only)

⚠ Notes:

1. The interface and functions shown in the instructions below are for reference only.
2. The touch function cannot be used in Onekey TV mode.
3. You must be in TV mode to perform these operations.

Scan for channels

Press the **MENU** button on the remote control, then select **Setup** → **Auto Scan** to scan for channels and store them in the TV automatically.



Language settings

Press the **MENU** button on the remote control, then select **Setup** → **Language**.

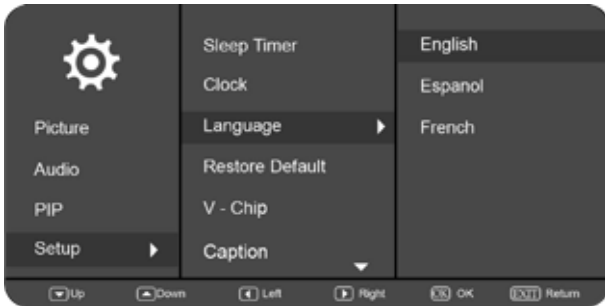

Picture In Picture (PIP) Size

Press the **MENU** button on the remote control, then select **PIP** → **PIP Size** to adjust the size of the sub-picture.

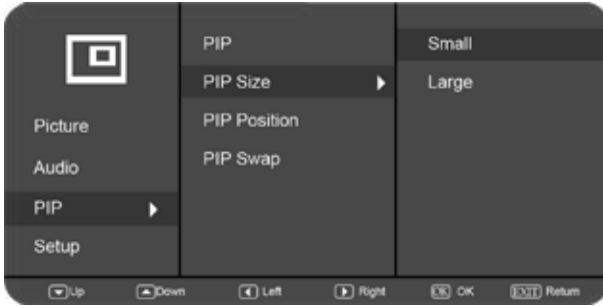

Note: When in PIP mode, press the  button on the remote control to alternate the video between the main picture and sub-picture.

Record TV

The Onekey TV must be turned off in order to use the recording function. Once it is turned off, use Windows Media Center or the Total Media software in PC mode to record TV programs.

Onekey TV Instructions (DVB-T model) (selected models only)

ⓘ Notes:

1. The interface and functions shown in the instructions below are for reference only.
2. The touch function cannot be used in Onekey TV mode.
3. You must be in TV mode to perform these operations.

Scan for channels

Press the **MENU** button on the remote control, then select **Setup** → **Channels** to scan for channels and store them in the TV automatically.

ⓘ **Note:** The default password is “8888”. Change the password by using the Password option.

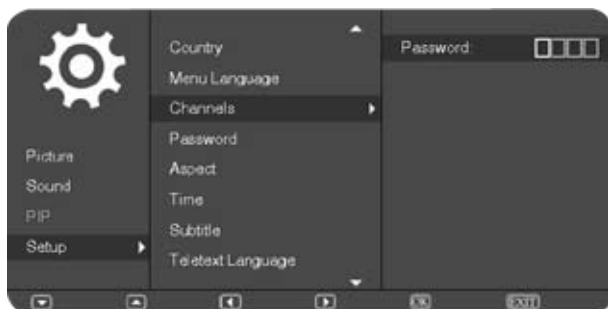

ⓘ **Note:** If a channel is locked using the Child Lock function, press the  button to unlock it.

Language settings

Press the **MENU** button on the remote control, then select **Setup** → **Menu Language**.

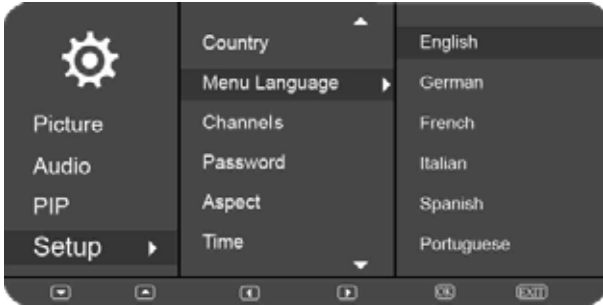

Picture In Picture (PIP) Size

Press the **MENU** button on the remote control, then select **PIP** → **PIP Size** to adjust the size of the sub-picture.

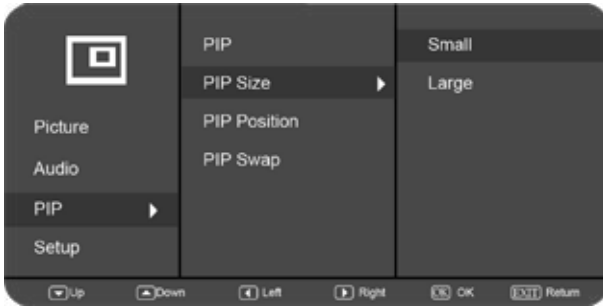

Note: When in PIP mode, press the  button on the remote control to alternate the video between the main picture and sub-picture.

Password settings

You need to enter the original password before setting a new password or removing the password. The default password is “8888”.

! **Note:** If you forget the password you entered, enter the **Super Password** “1357” to set a new password.

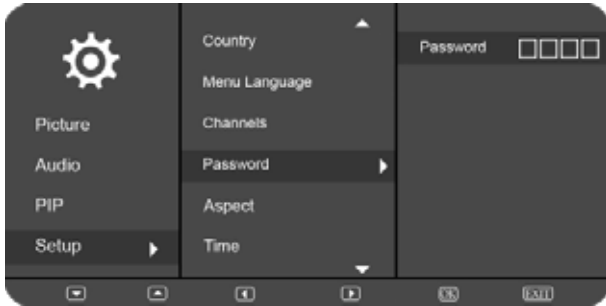

Record TV

The Onekey TV must be turned off in order to use the recording function. Once it is turned off, use Windows Media Center or the Total Media software in PC mode to record TV programs.

Onekey TV Instructions (ATV model) (selected models only)

⚠ Notes:

1. The interface and functions shown in the instructions below are for reference only.
2. The touch function cannot be used in Onekey TV mode.
3. You must be in TV mode to perform these operations.

Scan for channels

- 1) Press the **MENU** button on the remote control, then select **Setup** → **Auto Scan** to scan for channels and store them in the TV automatically.

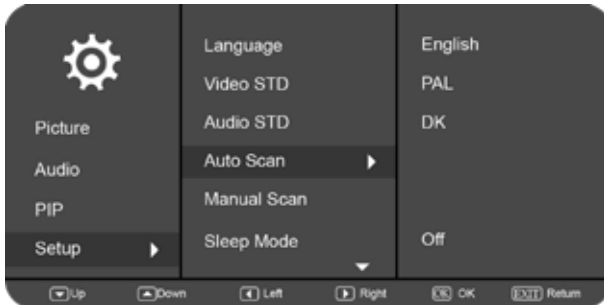

- 2) Press the **MENU** button on the remote control, then select **Setup** → **Manual Scan** to scan for channels and store them in the TV automatically.

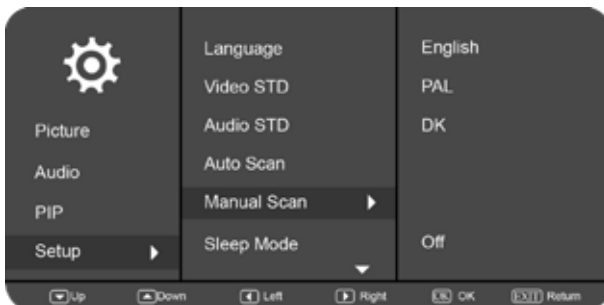

Language settings

Press the **MENU** button on the remote control, then select **Setup** → **Language**.

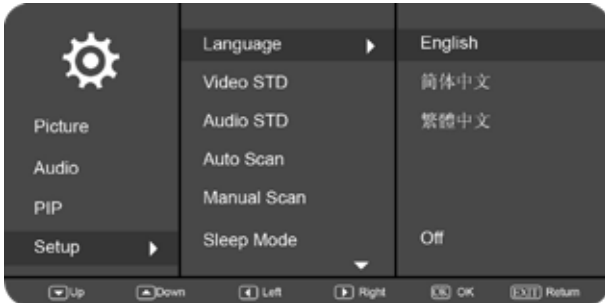

Picture In Picture (PIP) Size

Press the **MENU** button on the remote control, then select **PIP** → **PIP Size** to adjust the size of the sub-picture.

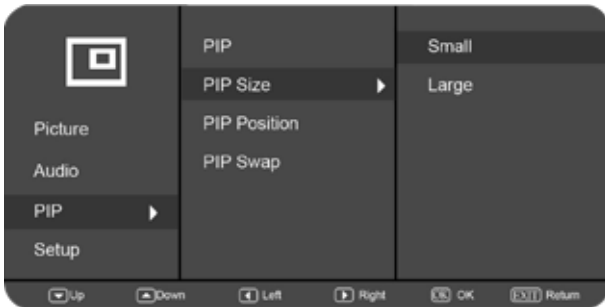

! **Note:** When in PIP mode, press the **Video** button on the remote control to alternate the video between the main picture and sub-picture.

Record TV

The Onekey TV must be turned off in order to use the recording function. Once it is turned off, use Windows Media Center or the Total Media software in PC mode to record TV programs.

Using the Rescue System

This chapter contains the following topics:

- OneKey Recovery
- Driver and Application Installation



Attention: Using OneKey Recovery will result in loss of data.

- You can restore the C: drive of the computer to factory default settings or to the last system backup status using **OneKey Recovery**. If you do this, all of the existing data on drive C: will be lost, but the content and format of the other partitions of the hard disk drive will remain unchanged.
- If you want to install an operating system and back it up with **OneKey Recovery**, you must format the C: partition in **NTFS** format and install the operating system on the C: partition. Otherwise, the **OneKey Recovery** system cannot run.

Note about the service partition:

The files and relevant data used by the rescue system are saved in the service partition. Deleting this partition will make the rescue system unusable. For more detailed information, see the following instructions:

From the **Search** charm, select **Apps** → **Control Panel** → **Administrative Tools** → **Computer Management** → **Disk Management**, you can see the service partition, which must not be deleted.

 **Note:** The recovery files and relevant data used by the rescue system are saved in the service partition. If the service partition is deleted or damaged by someone other than authorized Lenovo service personnel, Lenovo will not be liable for any losses arising therefrom in any way.

OneKey Recovery

OneKey Recovery is an easy-to-use application. You can use it to restore your computer to the system default or to a previously backed up state.

Detailed Operation Procedure

1. Repeatedly press and release the **F2** key after turning on the computer until the **Lenovo Rescue System** opens, then select **OneKey Recovery**.

 **Note:** System Recovery will overwrite all of the data on the C: drive. To prevent loss of data, be sure to back up relevant data before performing system recovery.

2. Follow the on-screen instructions to select the backup task you want to restore from and the disk where you want to install the operating system, then press **Next** to start the restore.
3. Please wait during the process of system recovery. Do not interrupt the operation during the recovery process.
4. After the system is recovered successfully, the software will prompt you to restart the computer. Restart the computer and start the operating system.

Driver and Application Installation

The **Driver and Application Installation** function in the rescue system provides a way for the user to conveniently reinstall all of the Lenovo applications and drivers that were shipped with your Lenovo hardware.

Method 1: Automatic Installation

Repeatedly press and release the **F2** key after turning on the computer until the **Lenovo Rescue System** opens, then select **Drivers and Application Installation**.

Follow the on-screen prompts to install the Lenovo drivers and applications. Click **OK** to start installing the **Lenovo Drivers and Application Installation** software.

The system will restart. After the system has restarted, the drivers and application installation process will continue until it has completed.

Method 2: Manual Installation

In the Windows system, Click **Lenovo Rescue System** icon on the Windows desktop or Start screen. Then select **Drivers and Application Installation** in the pop-up dialog box.

After starting the procedure, install all the drivers and software manually by following the prompts.



Notes:

1. Do not install software which is already installed on the computer.
2. Make sure that the Drivers and Application Installation software has been automatically installed before starting the operating system. The manual installation function can only be used after the software has been installed.

Troubleshooting and Confirming Setup

This chapter contains the following topic:

- Troubleshooting and Problem Resolution

 **Note:** The description of the TV tuner card in this manual is only applicable to machines which have the TV tuner card. It does not apply to machines that do not have a TV tuner card.

Solving Problems

Follow these tips when troubleshooting your computer:

- If you added or removed a part before the problem started, review the installation procedures to ensure that the part is correctly installed.
- If a peripheral device does not work, ensure that the device is properly connected.
- If an error message appears on the screen, write down the exact message. This message may help support personnel diagnose and fix the problem(s).
- If an error message occurs in a program, see the Help document of this program.

Troubleshooting Display Problems

Problem: Blank screen or no image is displayed on the monitor.

Troubleshooting and problem resolution:

Check that the LCD screen has been turned on; If not, press the LCD On/Off button to turn on the LCD.

If still cannot solve the problem, contact Lenovo Customer Service.

Problem: You need to change the display property settings.

Setting display background and icon properties:

1. Right-click the desktop anywhere except over an icon, then select Personalize from the pop-up menu.
2. From here, select the appropriate options to:
 - Change the desktop background
 - Select a screen saver
 - Select Windows color options for borders and taskbar
 - Select a themes
3. Right-click the desktop anywhere except over an icon, then select **Screen resolution** from the pop-up menu to change the appearance.

Problem: Ripple on screen.

Troubleshooting and problem resolution:

1. Check to see if any of the following devices are located less than one meter from the computer: refrigerators, electric fans, electric dryers, UPS systems, regulators, fluorescent lamps or other computers that may be generating magnetic interference.

2. Move any interfering devices away from the computer.
3. If the problem persists, contact Lenovo Service.

Troubleshooting Touch screen

Problem: The touch screen reacts, but not where you are touching it.

Troubleshooting and problem resolution:

Touch Screen Calibration:

1. In Control Panel, select “Hardware and Sound”.
2. In “Hardware and Sound” window, select “Tablet PC Settings”.
3. In “Tablet PC Settings” dialogue, click “Calibrate” button.

Troubleshooting Audio Problems

Problem: No sound from the integrated speakers.

Troubleshooting and problem resolution:

- Adjust the Windows volume control — select the speaker icon from the **Settings** Charm or click the arrow on taskbar to show the hidden icons in Windows desktop mode, then click the speaker icon. Ensure that the volume is turned up and the sound is not muted. Adjust the volume, bass, or treble controls to eliminate distortion.
- Reinstall the audio driver.
- Disconnect any headphones from the headphone connector — sound from the speakers is automatically disabled when headphones are connected to the computer’s side-panel headphone connector.

Problem: No sound from headphones.

Troubleshooting and problem resolution:

- Check the headphone cable connection — ensure that the headphone cable is securely inserted into the headphone connector.
- Adjust the Windows volume control — select the speaker icon from the **Settings** Charm or click the arrow on taskbar to show the hidden icons in Windows desktop mode, then click the speaker icon. Ensure that the volume is turned up and the sound is not muted.

Troubleshooting Software Problems

Problem: You are unable to exit a running program normally.

Troubleshooting and problem resolution:

1. Open the **Task Manager** window by pressing **Ctrl, Alt** and **Delete** at the same time.
2. Select the problem program, then click the **End Task** button.

Problem: You need to install or uninstall a program.

Problem resolution:

During installation never abort the install process by powering the system off or through other drastic means. This can cause system program problems or even failure during system initialization.

During the uninstall process, never directly delete the files or folders. This is harmful to the operating system, and might cause a system-wide malfunction.

Use the following procedure to properly uninstall programs:

1. Back up all documents and system settings related to the program before removing it.
2. If the program has its own uninstaller, run it directly to uninstall the program.
3. If the program does not have its own uninstaller, then select **Apps → Control Panel** from the **Search** charm.
4. From the **Control Panel**, choose **Programs → Programs and Features**.
5. Find the applicable program from the **Programs and Features** dialog box and then select **Uninstall/Change**.
6. Perform the instructions displayed to uninstall the software.

Troubleshooting Problems with Optical Drives and Hard Disks

Problem: The Optical drive is unable to read a CD/DVD.

Troubleshooting and problem resolution:

1. Check to determine if there is an optical drive icon in the resource manager of the operating system. If not, restart your computer. If there is still no icon, contact Lenovo Service. Otherwise, continue with the next step of this procedure.
2. Confirm that the CD/DVD has been properly placed in the drive. If not, reload the CD or DVD. Otherwise, continue with the next step of this procedure.
3. Check the specifications that came with your computer to confirm that this optical drive is capable of reading this type of CD or DVD.
4. If the CD/DVD cannot be read, replace it with a known good CD/DVD such as one that was shipped with the computer.
5. If the known good CD cannot be read, visually check the operating side of the CD/DVD for defects.

Problem: The capacity of the hard disk, as indicated by the system, is less than the nominal capacity.

Troubleshooting and problem resolution: For computers equipped with the OneKey Recovery feature, the system recovery feature needs to occupy some hard disk space. This may account for the apparent hard disk capacity deficit.

Further Technical Explanation: The nominal capacity of the hard disk is expressed in the decimal system as 1000 bytes. But the actual hard disk capacity is expressed in the binary system as 1024 bytes (For example, the nominal capacity 1G is 1000M, while the actual capacity 1G is 1024M).

The capacity of the hard disk shown in Windows can be calculated according to the calculations in the following example:

The nominal capacity of the hard disk is 40G, while its actual capacity should be: $40 \times 1000 \times 1000 \times 1000 / (1024 \times 1024 \times 1024) = 37\text{G}$.

If the Service partition of 3G - $3 \times 1000 \times 1000 \times 1000 / (1024 \times 1024 \times 1024) = 2.79\text{G}$ is subtracted, the capacity of the hard disk shown in the system can be obtained.

The capacity of the hard disk as calculated using this method may be slightly different from the actual capacity due to the rounding of totals.

Special considerations for troubleshooting Windows

Record the following information as it may be useful later when troubleshooting system problems:

1. The drivers for this computer model only support the Windows 8 system.
2. When you use the Windows Media Center to watch TV, be particularly attentive to the following:
 - In the following two situations, you must re-save a channel list:
 - a. When you change your TV signal from digital to analog, your saved channel list for digital TV is deleted. When you want to watch digital TV again, you must create and save a new channel list.
 - b. When you change your TV signal from analog to digital, your saved channel list for analog TV is deleted. When you want to watch analog TV again, you must create and save a new channel list.
 - You must set the TV tuner input signal to analog before you can watch Teletext programming.

Windows Help and Support

If you have a problem with the operating system, see the Windows Help and Support file. To open the Windows Help and Support file, do one of the following:

- Select the **Settings** charm, then select **Help**.
- Press Windows key  + F1.

You can read the Windows Help and Support file on your computer. You can also get online help and support by clicking on one of the two links listed under **More to explore**.

BIOS setup utility

What is the BIOS setup utility?

The BIOS setup utility is ROM-based software. It communicates basic computer information and provides options for setting boot devices, security, hardware mode, and other preferences.

How can I start the BIOS setup utility?

To start the BIOS setup utility:

1. Shut down the computer.
2. Repeatedly press and release the F1 key after turning on the computer, then select **Startup** → **Boot Priority**.

How can I change the boot mode?

There are two boot modes: UEFI and Legacy. To change the boot mode, start the BIOS setup utility and set boot mode to UEFI or Legacy support on the boot menu.

When do I need to change the boot mode?

The default boot mode for your computer is the UEFI mode. If you need to install a legacy Windows operating system (any operating system before Windows 8) on your computer, you must change the boot mode to Legacy support. The legacy Windows operating system cannot be installed if you don't change the boot mode.

Performing Daily Maintenance Tasks

Cleaning the computer components

Because many of the computer components consist of sophisticated integrated circuit boards, it is very important to periodically clean the computer to prevent dust buildup. The cleaning supplies you need to clean the components include: a vacuum cleaner, a soft cotton cloth, pure water (preferably purified or distilled water) and cotton swabs.



Attention: Before you clean your computer, disconnect the computer from the electrical outlet. Clean your computer with a soft cloth dampened with water. Do not use liquid or aerosol cleaners, which may contain flammable substances.



Note: To avoid damaging the computer or display, do not spray cleaning solution directly onto the display. Only use products specifically designed for cleaning displays, and follow the instructions included with the product.

The following are general methods for cleaning the components:

- You can use a soft cloth to remove dust on the surface of the computer, the monitor, the printer, the speakers and the mouse.
- You can use a vacuum cleaner to clean in otherwise inaccessible corners.
- To clean the keyboard thoroughly, shut down the computer and scrub it gently with a wet cloth. Do not use the keyboard until it is dry.

Do not do any of the following:

- Allow water to enter the computer.
- Use a heavily dampened cloth.
- Spray water directly onto the surface of the monitor or inside the computer.

LCD monitor should be cleaned daily. Use a dry cloth to brush dust from the monitor and keyboard every day. Keep all surfaces clean and free of grease stains.

Hardware Replacement Guide



This chapter contains the following topics:

- Removing the computer cover
- Installing a wall mount bracket adapter
- Installing a B-CAS card
- Replacing a memory module
- Replacing the optical drive
- Replacing the hard disk drive
- Replacing the keyboard and mouse
- Replacing the power cord

Overview

This guide is intended to be used by customers who are replacing Customer Replaceable Units (CRUs) as well as trained service personnel who are replacing Field Replaceable Units (FRUs). In this guide, CRUs and FRUs will often be referred to as parts.

 **Note:** Trained service personnel should refer to the *Hardware Maintenance Manual* (HMM) for parts ordering information.

This guide does not include procedures for all parts. It is expected that cables, switches, and certain mechanical parts can be replaced by trained service personnel without the need for step-by-step procedures.

 **Note:** Use only parts provided by Lenovo®.

The description of the TV-Tuner card in this manual applies only to those computer models that have the TV-Tuner card installed. It does not apply to those computer models that do not have the TV-Tuner card installed.

This guide contains procedures for replacing the following parts:

- Memory modules
- Hard disk drive
- Optical drive
- Keyboard, mouse (wired)
- Power cord

Safety information for replacing CRUs

Do not open your computer or attempt any repairs before reading the “Important safety information” in the *Safety and Warranty Guide* that was included with your computer. If you no longer have this copy of the *Safety and Warranty Guide*, you can obtain one online from the Support Web site at <http://support.lenovo.com>.

Additional information resources

If you have Internet access, the most up-to-date information for your computer is available from the World Wide Web.

You can find the following information:

- CRU removal and installation information
- Publications
- Troubleshooting information
- Parts information
- Links to other useful sources of information

To access this information, go to: <http://support.lenovo.com>

Tools required

To disassemble the computer, you need the following tools:

- Wrist grounding strap and conductive mat for preventing electrostatic discharge
- Flat screwdriver
- Phillips screwdriver
- Hex screwdriver
- Plastic flat screwdriver
- Plastic tweezers



Note: The screws for the different components vary in size. During the disassembly procedure, group the screws with their corresponding components to avoid a mismatch when replacing the components.

Handling static-sensitive devices

Static electricity, although harmless to you, can seriously damage computer components.

When you are replacing a part, do not open the anti-static package containing the new part until the defective part has been removed from the computer and you are ready to install the new part.

When you handle parts and other computer components, take these precautions to avoid static electricity damage:

- Limit your movement. Movement can cause static electricity to build up around you.
- Always handle parts and other computer components carefully. Handle adapters, memory modules, system boards, and microprocessors by the edges. Never touch any exposed circuitry.
- Prevent others from touching the parts and other computer components.
- Before you replace a new part, touch the anti-static package containing the part to a metal expansion slot cover or other unpainted metal surface on the computer for at least two seconds. This reduces static electricity in the package and your body.
- When possible, remove the new part from the anti-static packaging, and install it directly in the computer without setting the part down. When this is not possible, place the anti-static package that the part came in on a smooth, level surface and place the part on it.
- Do not place the part on the computer cover or other metal surface.

Replacing hardware



Attention: Do not remove the computer cover or attempt any repairs before reading the “Important safety information” in the *Safety and Warranty Guide* that was included with your computer or in the *Hardware Maintenance Manual (HMM)* for the computer. To obtain copies of the *Safety and Warranty Guide* or *HMM*, go to the Support Web site at: <http://support.lenovo.com>



Note: Use only parts provided by Lenovo.

General information

Pre-disassembly instructions

Before proceeding with the disassembly procedure, make sure that you do the following:

1. Turn off the power to the system and all peripherals.
2. Unplug all power and signal cables from the computer.
3. Place the system on a flat, stable surface.

Removing the computer cover



Attention: Turn off the computer and wait 3 to 5 minutes to let it cool down before removing the cover.



Note: It may be helpful to place the computer face-down on a soft flat surface for this procedure. Lenovo recommends that you use a blanket, towel, or other soft cloth to protect the computer screen from scratching or other damage.

To remove the computer cover

1. Remove any media (disks, CDs, or memory cards) from the drives, shut down the operating system, and turn off the computer and all attached devices.
2. Unplug all power cords from electrical outlets.
3. Disconnect all cables attached to the computer. This includes power cords, input/output (I/O) cables, and any other cables that are connected to the computer. Refer to “Left and right view” and “Rear view” for help with locating the various connectors.

4. Remove the 2 cover pieces by sliding them in opposite directions as shown.

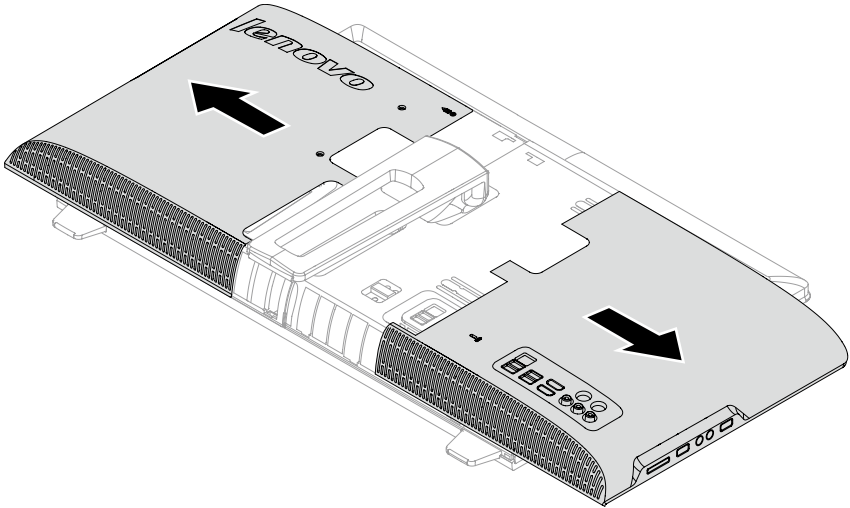

Mounting the computer onto a wall

The computer can be mounted onto a wall. Before doing this, you will first need to install a UL listed **VESA wall mount*** (to be purchased separately) onto the back of the computer.

To install a VESA wall mount

! **Note:** It may be helpful to place the computer face-down on a soft flat surface for this procedure. Lenovo recommends that you use a blanket, towel, or other soft cloth to protect the touch screen from scratching or other damage.

* **VESA wall mount spec:** VESA100, 100mm x 100mm, M4 bolts.

1. Push the stand lock upward to unlock it and then slide the stand out.

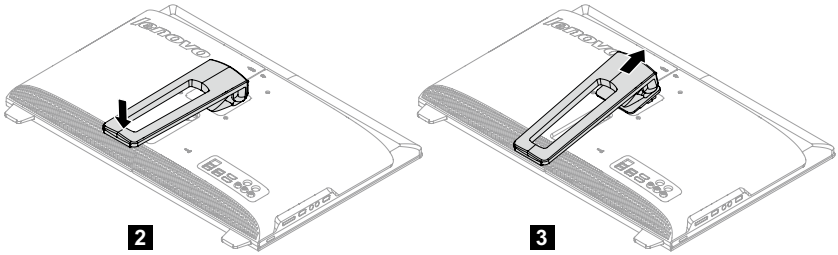
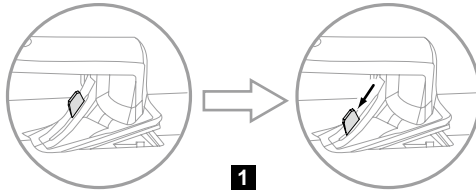

2. Align the VESA wall mount with the mounting holes on the computer, and then secure it to the computer with the 4 screws.

Installing a B-CAS card



Attention: Before using the TV function, a B-CAS card will need to be installed on to the computer. Follow the steps below to install the B-CAS card.



Notes:

Before installing the B-CAS card, make sure that you do the following:

- Turn off the power to the system and all peripherals.
- Unplug all power and signal cables from the computer.
- Place the system on a flat, stable surface.

1. Remove the computer cover. Refer to “Removing the computer cover”.
2. Insert the B-CAS card into the card port.

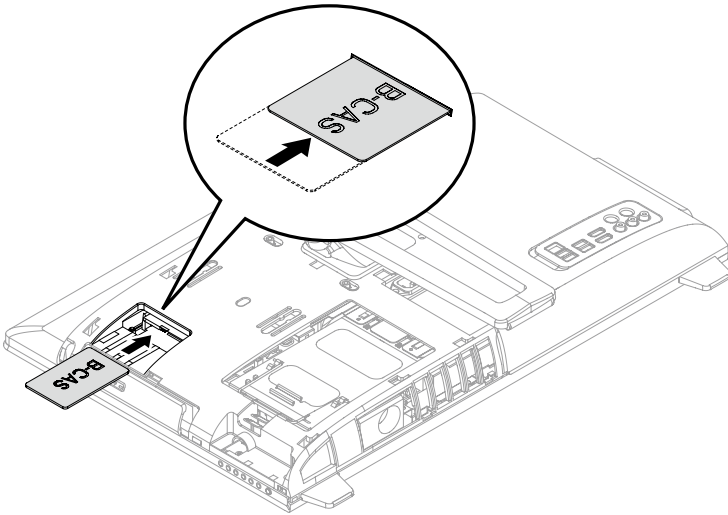

3. Align then slide the computer cover back into position.

Replacing a memory module



Attention: Turn off the computer and wait 3 to 5 minutes to let it cool down before removing the cover.



Note: It may be helpful to place the computer face-down on a soft flat surface for this procedure. Lenovo recommends that you use a blanket, towel, or other soft cloth to protect the touch screen from scratching or other damage.

1. Remove any media (disks, CDs, or memory cards) from the drives, shut down the operating system, and turn off the computer and all attached devices.
2. Unplug all power cords from electrical outlets.
3. Disconnect all cables attached to the computer. This includes power cords, input/output (I/O) cables, and any other cables that are connected to the computer. Refer to “Left and right view” and “Rear view” for help with locating the various connectors.
4. Remove the computer cover. Refer to “Removing the computer cover”.
5. Push out the latches on both sides of the memory socket to release the memory module and gently pull the memory module upward to remove it from its socket. All of the memory modules can be removed by using the same procedure.

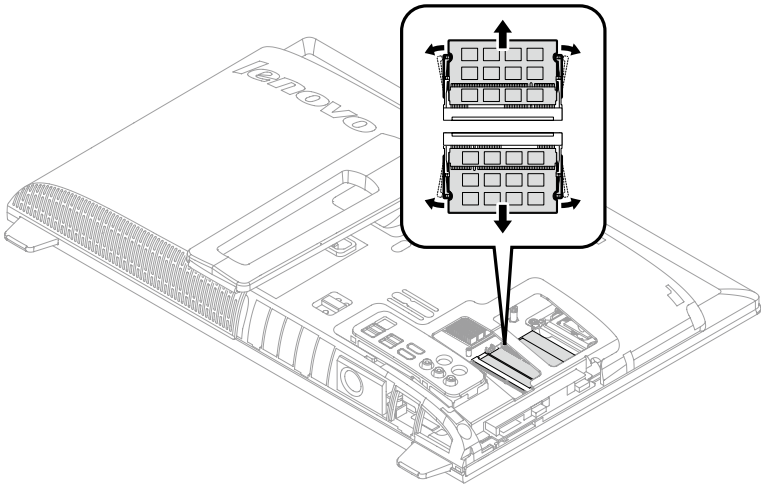

6. Align then insert the new memory module into the socket and push down on the top edge of the memory module. Make sure the latches lock the memory module in place.
7. Align then slide the computer cover back into position.

Replacing the optical drive



Attention: Turn off the computer and wait 3 to 5 minutes to let it cool down before replacing the optical drive.

To remove the optical drive:



Note: It may be helpful to place the computer face-down on a soft flat surface for this procedure. Lenovo recommends that you use a blanket, towel, or other soft cloth to protect the screen from scratching or other damage.

1. Remove any media (disks, CDs, or memory cards) from the drives, shut down the operating system, and turn off the computer and all attached devices.
2. Unplug all power cords from electrical outlets.
3. Disconnect all cables attached to the computer. This includes power cords, input/output (I/O) cables, and any other cables that are connected to the computer. Refer to “Left and right view” and “Rear view” for help with locating the various connectors.
4. Remove the computer cover. Refer to “Removing the computer cover”.
5. Push down the pin that locks the optical disk drive to the chassis then use the screwdriver push the disk out. **1 2**

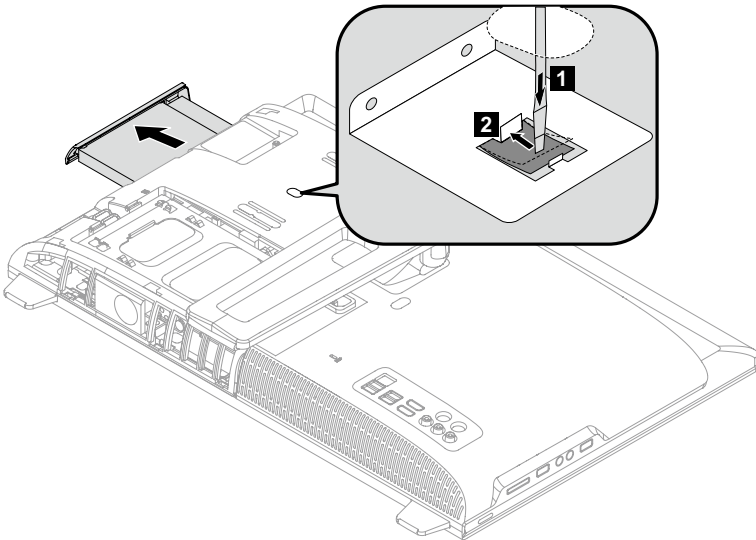

6. Push a small iron stick (paper clip) into the small hole on the optical drive cover so that the disk springs out as shown.

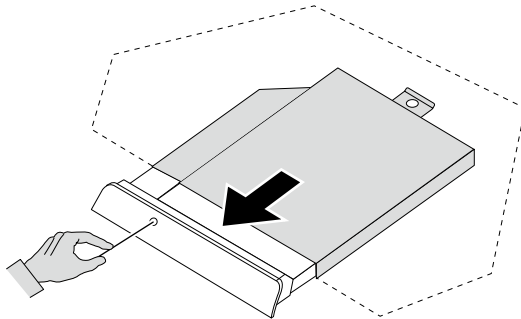

7. Remove the 2 screws that secure the optical drive to the metal bracket. **1**
8. Use a small flat head screwdriver to press and push out the pins that secure the cover to the disk. **2 3**
9. Separate the cover from the defective optical drive.

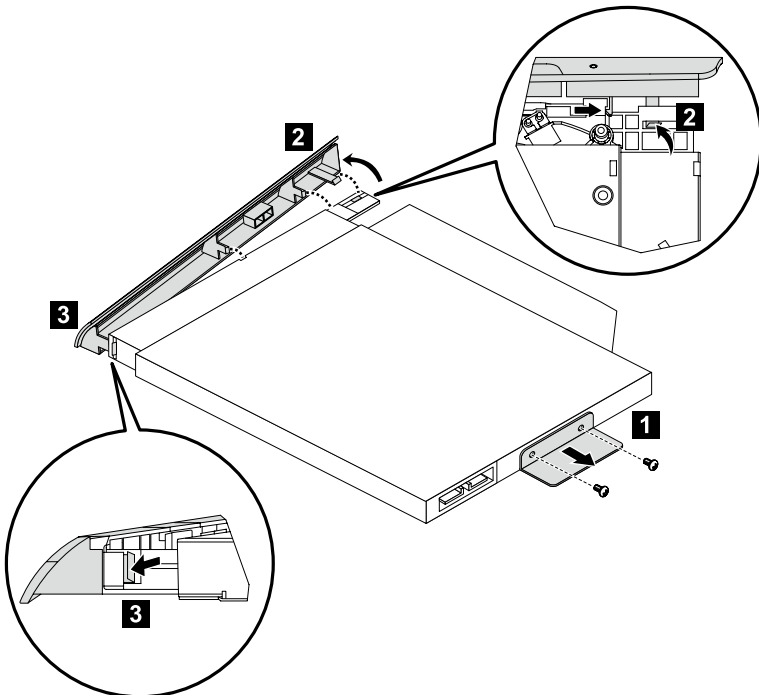

10. Install the new optical drive as follows:
 - (1) Align the new optical drive with the cover, and then push the cover back into position.
 - (2) Screw the metal bracket back onto the new optical drive.
 - (3) Slide the new optical drive into the drive bay.
11. Screw the new optical drive back onto the chassis.
12. Slide the computer cover back into position.

Replacing the hard disk drive



Attention: Turn off the computer and wait 3 to 5 minutes to let it cool down before replacing the hard disk drive.

To replace the hard disk drive:



Note: It may be helpful to place the computer face-down on a soft flat surface for this procedure. Lenovo recommends that you use a blanket, towel, or other soft cloth to protect the screen from scratching or other damage.

1. Remove the computer cover. Refer to “Removing the computer cover”.

2. Push then slide the hard disk drive and bracket out of the chassis as shown.

1 2

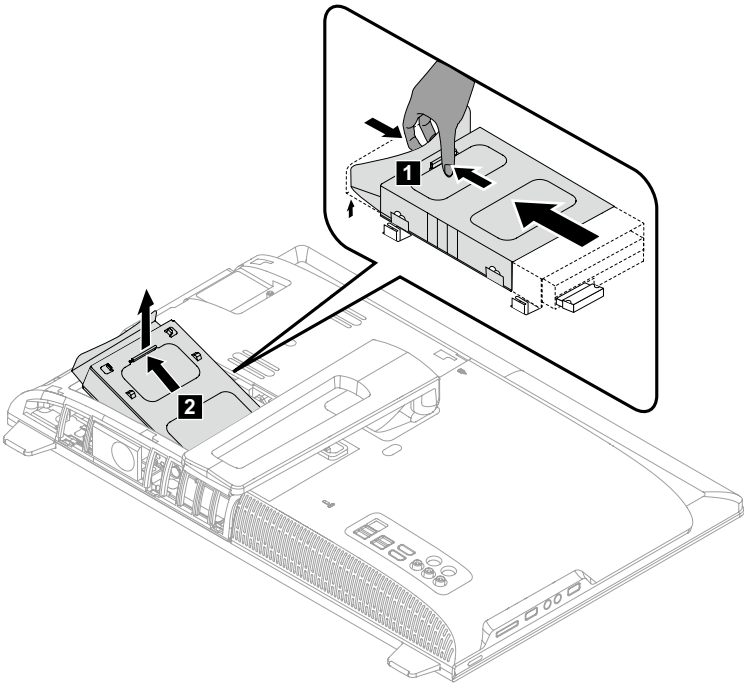

3. Push the pins and release the hard disk drive from the bracket.

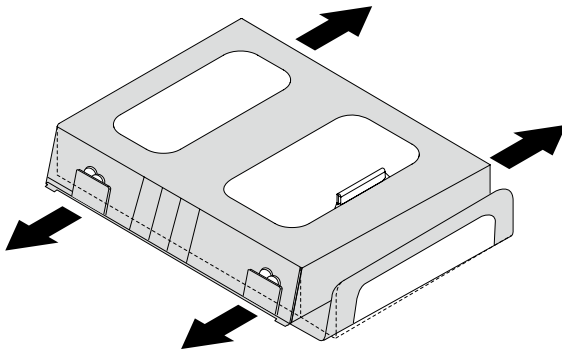

4. Install the new hard disk drive as follows:
Line up the new hard disk drive with the bracket and secure it with the pins.
5. Slide the hard disk drive and bracket back into position.
6. Slide the computer cover back into position.

Replacing the keyboard and the mouse



Attention: Do not remove the computer cover or attempt any repairs before reading the “Important safety information” in the *Safety and Warranty Guide* that was included with your computer or in the *Hardware Maintenance Manual (HMM)* for the computer. To obtain copies of the *Safety and Warranty Guide* or *HMM*, go to the Support Web site at: <http://support.lenovo.com>

To replace the keyboard:

1. Remove any media (disks, CDs, or memory cards) from the drives, shut down the operating system, and turn off the computer and all attached devices.
2. Unplug all power cords from electrical outlets.
3. Locate the connector for the keyboard. Refer to “Left and right view” and “Rear view”.



Note: Your mouse will be connected to the USB connector at either side or the rear of the computer.

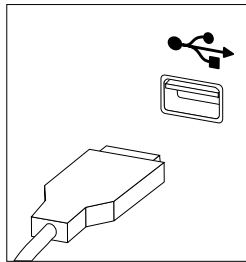

4. Disconnect the defective keyboard cable from the computer and connect the new keyboard cable to the same connector.

* **The mouse can be replaced using the same method.**

Replacing the power cord



Attention: Do not remove the computer cover or attempt any repairs before reading the “Important safety information” in the *Safety and Warranty Guide* that was included with your computer or in the *Hardware Maintenance Manual (HMM)* for the computer. To obtain copies of the *Safety and Warranty Guide* or *HMM*, go to the Support Web site at: <http://support.lenovo.com>

To replace the power cord:

1. Remove any media (disks, CDs, or memory cards) from the drives, shut down the operating system, and turn off the computer and all attached devices.
2. Locate the connector for the power cord. Refer to “Rear view”.

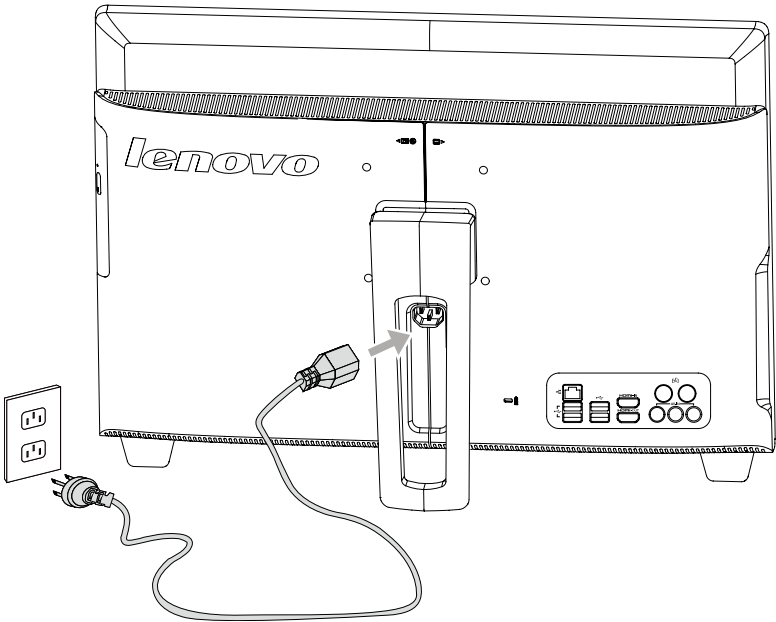

3. Disconnect the defective power cord from the computer and connect the new power cord to the same connector.

Appendix.

Declaration

Thank you for using Lenovo products.

Carefully read all documents shipped with your computer before you install and use the product for the first time. Lenovo is not responsible for any loss except when caused by installation and operations performed by Lenovo professional service personnel. You are responsible if you fail to operate the product according to instructions and requirements in the manuals included with your computer, or operate the product inappropriately.

This manual could include technical inaccuracies or typographical errors. Changes are made periodically to the information herein; these changes will be incorporated in new editions of the publication. To provide better service, Lenovo reserves the right to improve and/or modify the products and software programs described in the manuals included with your computer, and the content of the manual, at any time without additional notice.

The manuals included with your computer are provided to help you use Lenovo's products appropriately. For the configuration of the product, refer to the related contract (if any) or product packing list, or consult the distributor for the product sales.

The content of the manuals included with your computer is protected by copyright laws and rules. None of the manuals included with your computer may be reproduced or transcribed by any means or translated into any language without prior written permission of Lenovo.

The software interface and function and hardware configuration described in the manuals included with your computer might not match exactly the actual configuration of the computer that you purchase. You are welcome to contact us about the manuals included with your computer. For the latest information or any questions or comments, contact or visit the Lenovo Web site:

Service Web site: <http://support.lenovo.com>

Trademarks

Lenovo and the Lenovo logo, IdeaCentre and IdeaCentre logo are trademarks of Lenovo in the United States, other countries, or both.

Microsoft, Windows, and Windows Vista are trademarks of the Microsoft group of companies.

Intel Inside is a trademark of Intel Corporation in the U.S. and/or other countries.

AMD, the AMD Arrow logo, ATI, AMD Athlon, AMD LIVE!, AMD Opteron, AMD Phenom, AMD Sempron, Catalyst, Cool 'n' Quiet, CrossFire, PowerPlay, Radeon, and The Ultimate Visual Experience are trademarks of Advanced Micro Devices, Inc.

Other company, product, or service names referred to herein or in other Lenovo publications may be trademarks or service marks of others.

All rights reserved.

Names or marks of certain companies mentioned in the manuals included with your computer or this document do not necessarily indicate that related software or hardware is included. The actual configuration of the product depends on the packing list description.

Energy Star Statement



ENERGY STAR® is a joint program of the U.S. Environmental Protection Agency and the U.S. Department of Energy aimed at saving money and protecting the environment through energy efficient products and practices.

Lenovo is proud to offer our customers products with an ENERGY STAR compliant designation. The following machine types have been designed and tested to conform to the ENERGY STAR program requirement for computers at the time of manufacture. For more information about ENERGY STAR ratings for Lenovo computers, go to <http://www.lenovo.com>.

- 10097/2566
- 10099/2568
- 10101/3363
- 10098/2567
- 10100/4749

By using ENERGY STAR compliant products and taking advantage of the power-management features of your computer, you reduce the consumption of electricity. Reduced electrical consumption contributes to potential financial savings, a cleaner environment, and the reduction of greenhouse gas emissions.

For more information about ENERGY STAR, go to: <http://www.energystar.gov>.

Lenovo encourages you to make efficient use of energy an integral part of your day-to-day operations. To help in this endeavor, Lenovo has preset the following power-management features to take effect when your computer has been inactive for a specified duration:

ENERGY STAR power-management features, by operating system.

Microsoft Windows Vista, Windows 7 and Windows 8
Power plan: Balanced <ul style="list-style-type: none">• Turn off the display: After 10 minutes• Put the computer to sleep: After 25 minutes• Advanced power settings:<ul style="list-style-type: none">- Turn off hard disk drives: After 20 minutes- Hibernate: Never

To awaken your computer from a Sleep or System Standby mode, press any key on your keyboard. For more information about these settings, refer to your Windows Help and Support information system.

Enabling ErP compliance mode

You can enable the energy-related products directive (ErP) compliance mode through the **Power** menu in the Setup Utility program. This mode reduces electricity consumption when your computer is in standby mode or turned off.

To enable ErP compliance mode in the Setup Utility program, do the following:

1. Repeatedly press and release the F1 key when turning on the computer to start the Setup Utility program.
2. From the Setup Utility program main menu, select **Power** → **ErP** and press Enter.
3. Select **Enabled** and press Enter.
4. Press F10 to save changes and exit the Setup Utility program. Press Enter when prompted to confirm.

 **Note:** When ErP compliance mode is enabled, you only can wake up your computer by pressing the power switch.

Free Manuals Download Website

<http://myh66.com>

<http://usermanuals.us>

<http://www.somanuals.com>

<http://www.4manuals.cc>

<http://www.manual-lib.com>

<http://www.404manual.com>

<http://www.luxmanual.com>

<http://aubethermostatmanual.com>

Golf course search by state

<http://golfingnear.com>

Email search by domain

<http://emailbydomain.com>

Auto manuals search

<http://auto.somanuals.com>

TV manuals search

<http://tv.somanuals.com>