



Lenovo 5110 DigitalPrinter™

Lenovo 6110 DigitalPrinter™

User's Guide for Windows

- **Setup troubleshooting**

A checklist to find solutions to common setup problems.

- **Printer overview**

Learn about the printer parts and the printer software.

- **Printing ideas**

How to print several projects on various types of paper.

- **Maintenance**

Caring for your cartridges and ordering supplies.

- **General troubleshooting**

Error messages, print quality problems, paper jams, and much more.

May 2003

Edition: May 2003

This publication could include technical inaccuracies or typographical errors. Changes are periodically made to the information herein; these changes will be incorporated in later editions. Improvements or changes in the products or the programs described may be made at any time.

References in this publication to products, programs, or services do not imply that the manufacturer intends to make these available in all countries in which it operates. Any reference to a product, program, or service is not intended to state or imply that only that product, program, or service may be used. Any functionally equivalent product, program, or service that does not infringe any existing intellectual property right may be used instead. Evaluation and verification of operation in conjunction with other products, programs, or services, except those expressly designated by the manufacturer, are the user's responsibility.

This software and any accompanying documentation provided under this agreement are commercial computer software and documentation developed exclusively at private expense.

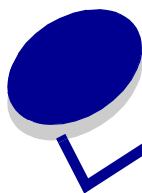

Contents

Chapter 1: Printer overview	5
Understanding the printer parts.....	5
Using memory cards (Lenovo 6110 only).....	7
Using the printer software	8
Using the paper type sensor	12
Chapter 2: Printing ideas.....	13
Printing on plain paper	13
Printing photos	14
Printing on premium or coated paper	16
Printing on both sides of a sheet of paper.....	17
Printing cards	19
Printing envelopes.....	21
Printing color images in black and white	23
Printing a booklet.....	24
Printing labels.....	27
Printing handouts	29
Printing a poster	31
Printing iron-on transfers	34
Printing transparencies.....	35
Printing your document in reverse order	37
Printing a banner.....	39
Printing on custom size paper	41
Chapter 3: Maintenance.....	43
Replacing the print cartridges.....	43
Aligning the print cartridges.....	47
Improving print quality	47

Preserving the print cartridges	49
Ordering supplies	50
Chapter 4: Setup troubleshooting	51
Troubleshooting checklist.....	51
Solving printer software installation problems.....	52
Chapter 5: General troubleshooting.....	55
Understanding error messages and flashing lights	55
Resolving unsuccessful or slow printing.....	57
Clearing paper misfeeds or jams.....	59
Solving print quality problems	60
Solving specialty media problems	63
Service station in China.....	64
Notices	66
Glossary.....	67
Index.....	71

1

Printer overview

Understanding the printer parts

Lenovo 5110 DigitalPrinter™

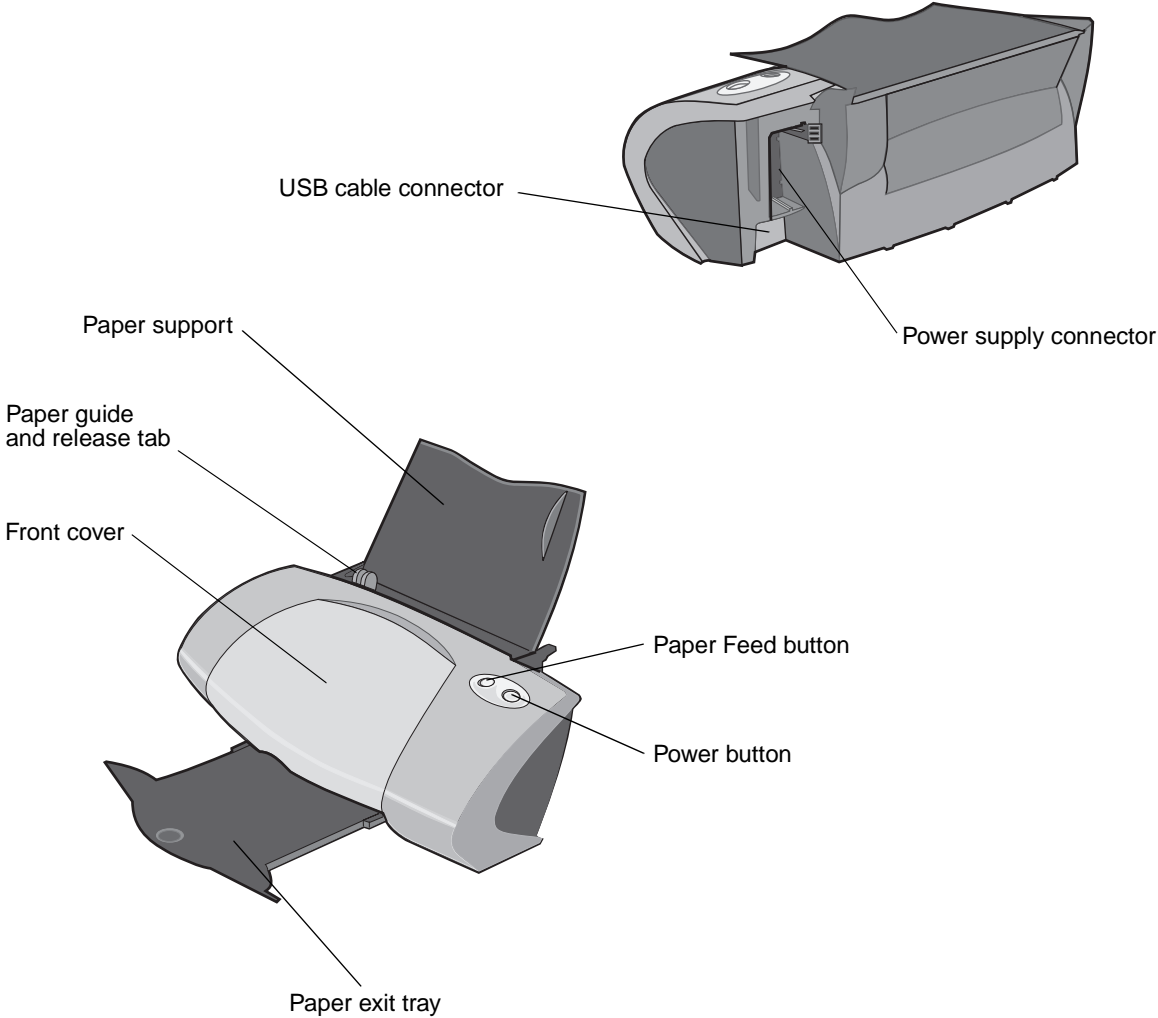

Lenovo 6110 DigitalPrinter™

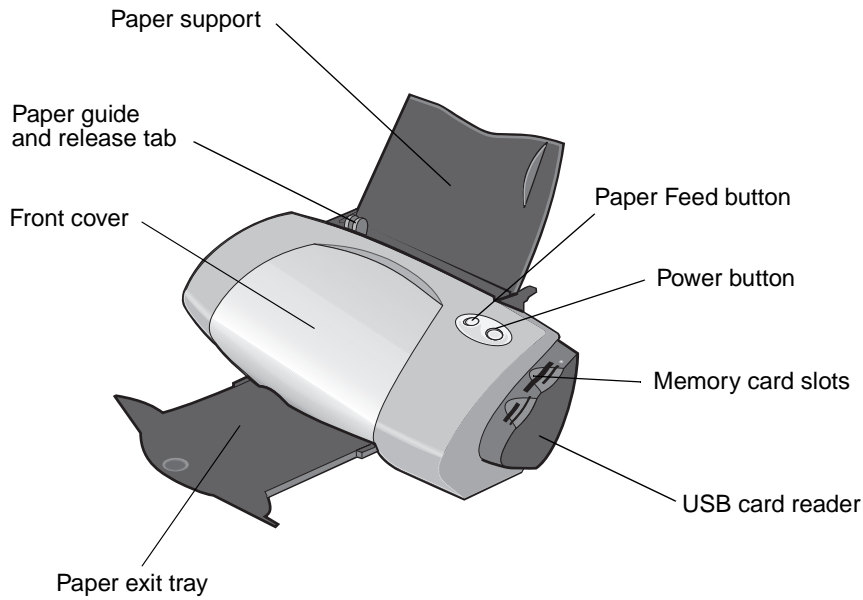
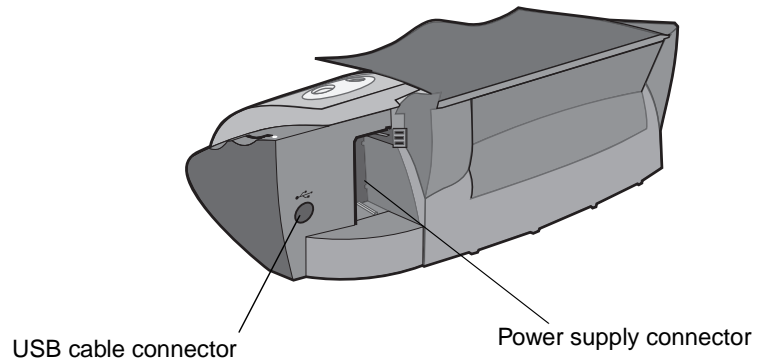

The following table describes each part.

Use this:	When you want to:
Front cover	<ul style="list-style-type: none"> • Install or change print cartridges. • Clear paper jams.
Memory card slots	Access your photos.
Paper exit tray	Stack paper after printing.

Use this:	When you want to:
Paper Feed button	<ul style="list-style-type: none"> • Eject paper from the printer. • Check the printer status. For more information, see “Understanding error messages and flashing lights” on page 55.
Paper guide and release tab	Make sure paper feeds correctly into the printer.
Paper support	Keep paper straight in the sheet feeder.
Power button	<ul style="list-style-type: none"> • Turn the printer on or off. • Check the printer status. For more information, see “Understanding error messages and flashing lights” on page 55.
Power supply connector	Supply power to the printer.
USB cable connector	Connect the printer to the computer.
USB card reader	Transfer data from a memory card to your computer.

Using memory cards (Lenovo 6110 only)

Most digital cameras use a memory card to store photos. You can insert the memory card into your printer and print your photos or save them on your computer.

Inserting a memory card

Your printer supports the following digital media:

- CompactFlash Type I and Type II
- IBM Microdrive
- Secure Digital
- MultiMedia Card
- Memory Stick
- SmartMedia

The USB card reader on your printer has four slots to accommodate these media. This illustration shows you where to insert each of the supported memory cards.

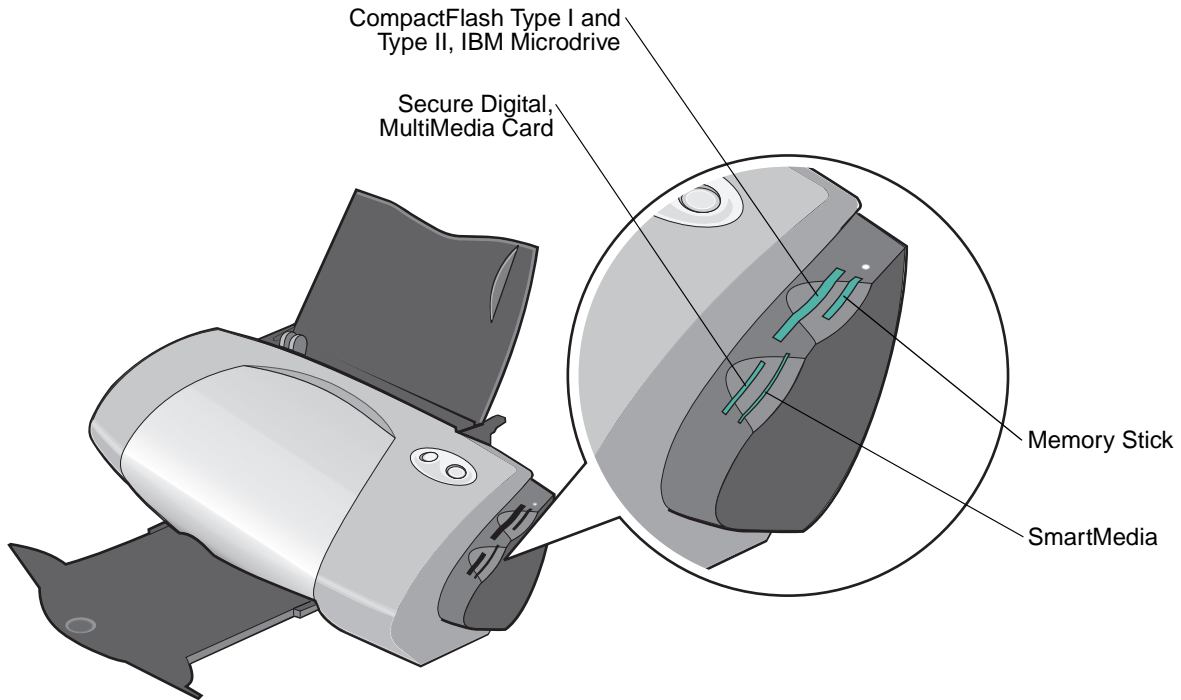

Before you insert your memory card, consider the following information:

- Insert only one memory card at a time.
- A small light on top of the card reader comes on once your card is properly installed.

If you are inserting a memory card of this type:	Make sure:
<ul style="list-style-type: none"> • CompactFlash Type I and II • IBM Microdrive 	The name label faces toward the printer.
<ul style="list-style-type: none"> • Memory Stick • Secure Digital • MultiMedia Card 	The gold contact area faces away from the printer.
<ul style="list-style-type: none"> • SmartMedia 	The gold contact area faces toward the printer.

Using the printer software

Your printer software works with your operating system to print documents with superior results. This software has two parts: the Printer driver and the Lenovo Solution Center.

Printer driver

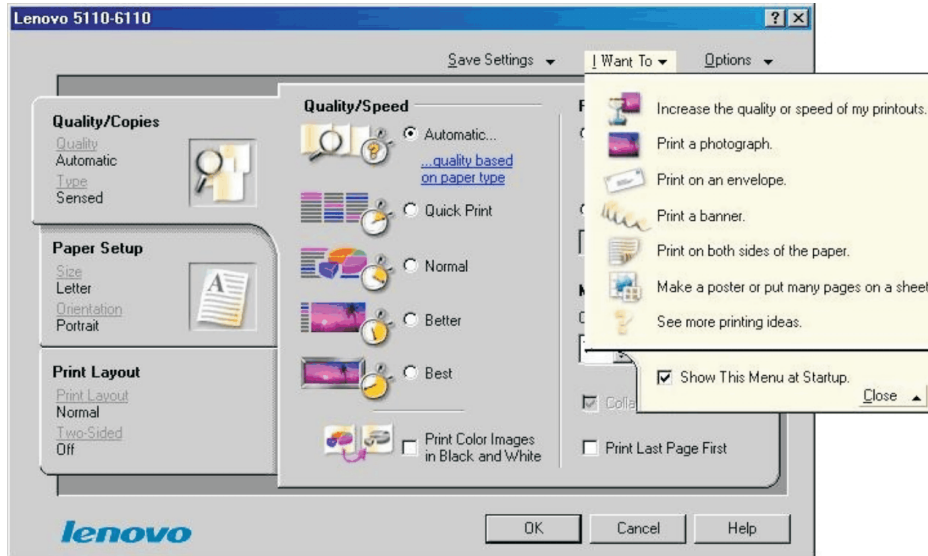

You can change your printer settings in the printer driver. To print a typical document on plain paper, you do not need to change your printer settings. When you install the printer software, the Print Properties are set to these default settings:

- Paper Type: Use Printer Sensor
- Quality/Speed: Automatic
- Paper Size: A4 or Letter
- Orientation: Portrait
- Layout: Normal

For more information about the printer settings for different types of print jobs, see “Printing ideas” on page 13.

Customizing the settings for your document

- 1 With your document open, click **File** ▶ **Print**.
The Print dialog box appears.
- 2 From the Print dialog box, click **Properties**, **Preferences**, or **Options**.
- 3 From the Quality/Copies tab, select a print quality setting.
- 4 From the Paper Setup tab, select a paper type and size setting.
- 5 From the Print Layout tab, change the layout of your document.

6 Click **OK** to apply your settings.

Quality/Copies tab

From:	Select:
Paper Type	<ul style="list-style-type: none"> • Use printer sensor when you want the paper type sensor to detect the paper in your printer. • Use my choice when you want to select the paper type.
Quality/Speed	<ul style="list-style-type: none"> • Automatic when you want the printer to select the correct print quality for the detected paper type. • Quick Print when you want to print documents quickly, but with reduced print quality. • Normal when you want to print most documents on plain paper. • Better when you want to print photos and documents containing graphics on coated or glossy paper. • Best when you want to print crisp photos and high resolution graphics, but with reduced speeds.
Multiple Copies	<ul style="list-style-type: none"> • Collate Copies if you want to print more than one copy of a document. This option prints all the pages of the first copy, and then all the pages of the second copy, and so on. • Print Last Page First if you want to print the pages in reverse order. • The number of copies you want to print.
	<p>Print Color Images in Black and White to save the ink in your color cartridge.</p> <p>Note: This option is not available if a black cartridge is not installed.</p>

Paper Setup tab

From:	Select:
Paper Size	Paper, Envelope, Banner, or Borderless , and then select the size specific to your paper type. If your paper size is not listed, select Custom Size . For help, see page 41.
Orientation	Portrait or Landscape .

Print Layout tab

From:	Select:
Layout	Normal, Banner, Mirror, N-up, Poster, or Booklet .
Duplexing	<ul style="list-style-type: none"> • Two-Sided to print your document on both sides of the page. • Side Flip or Top Flip to set which way the pages of your finished documents turn. <p>Note: If you select Side Flip, the pages of your document turn like the pages of a magazine. If you select Top Flip, the pages turn like the pages of a legal pad.</p>

Lenovo Solution Center

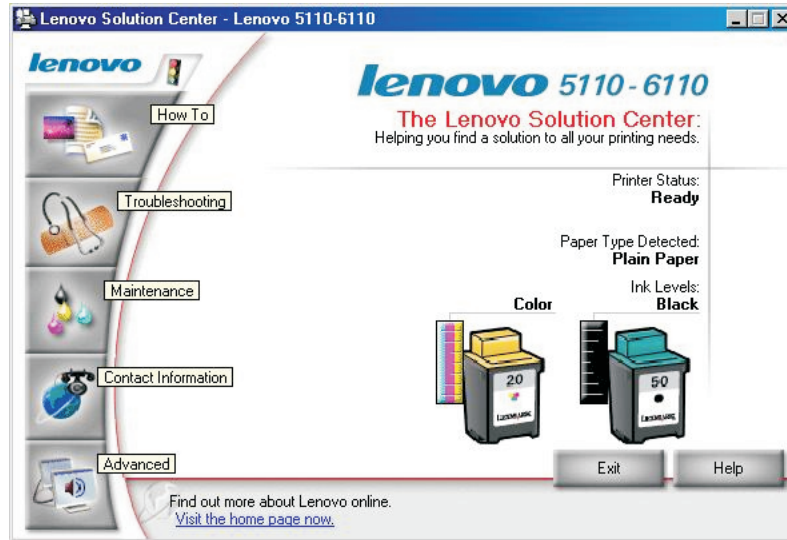

The Lenovo 5110-6110 Solution Center (LSC) is a guide you can refer to for printer help.

There are two ways to open the LSC:

- Click **Start** ▶ **Programs** ▶ **Lenovo 5110-6110** ▶ **Lenovo 5110-6110 Solution Center**.
- Double-click the **Lenovo 5110-6110 Solution Center** desktop icon.

The following table describes the LSC tabs:

From this tab:	You can:
How To	<ul style="list-style-type: none"> • Receive printer information. • Receive basic printing tips. • Receive printing project information.
Troubleshooting	<ul style="list-style-type: none"> • View tips for your printer status. • View common troubleshooting topics.
Maintenance	<ul style="list-style-type: none"> • Install a print cartridge. • View information about how to purchase new cartridges. • Clean the print cartridge nozzles. • Align the cartridges. • Solve other problems. <p>Note: Do not click this tab while a job is in progress.</p>

From this tab:	You can:
Contact Information	<ul style="list-style-type: none"> • View information about ordering supplies. • Receive contact information for Lenovo Customer Support.
Advanced	<ul style="list-style-type: none"> • Change printing status appearance options.

Using the paper type sensor

Your printer has a paper type sensor that detects these paper types:

- Plain paper
- Transparencies
- Coated paper
- Glossy/Photo paper

If you want the printer to select your paper type:

- 1 With your document open, click **File** ▶ **Print**.
The Print dialog box appears.
- 2 From the Print dialog box, click **Properties**, **Preferences**, or **Options**.
- 3 From the Print Properties dialog box, select the **Quality/Copies** tab.
- 4 From the Paper Type area, select **Use printer sensor**.

Note: Your printer can detect the type of paper you are using; it cannot detect the paper size.

If you want to turn the paper type sensor off and select your paper type:

- 1 With your document open, click **File** ▶ **Print**.
The Print dialog box appears.
- 2 From the Print dialog box, click **Properties**, **Preferences**, or **Options**.
- 3 From the Print Properties dialog box, select the **Quality/Copies** tab.
- 4 From the Paper Type area, select **Use my choice**.

2

Printing ideas

Printing on plain paper

You can load up to 100 sheets of plain paper at a time, depending on the thickness of the paper.

Step 1: Load the paper

- Load the paper vertically against the right side of the paper support.

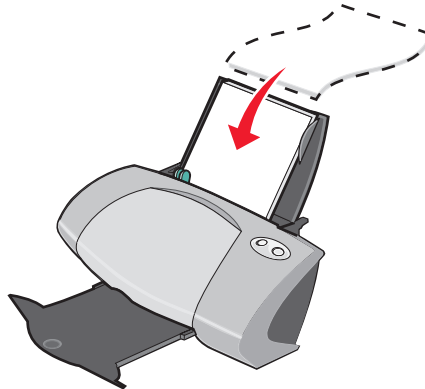

- Do not force the paper into the printer.
- Squeeze and slide the paper guide to the left side of the paper.

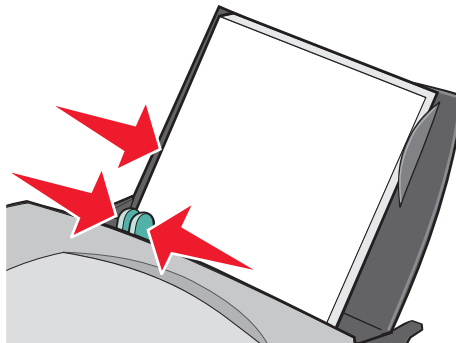

Note: If you are using letter size paper, adjusting the paper guide may not be necessary.

Step 2: Customize the print settings

If you are using plain A4 or letter size paper, and you want to print with normal print quality, you do not need to adjust the settings.

If you are using specialty media, follow the steps for your paper type.

Step 3: Print your document

Click **OK**.

Printing photos

For the best photo printing results, we recommend you use:

- The photo software included with your printer.
- A photo cartridge. For more information on cartridges, see page 43.
- Photo paper.

Note: You may want to print on plain paper before loading your photo paper and changing your settings. To print on photo cards, see page 19.

If you want to print a borderless photo using another software program, you may need to manually adjust settings such as:

- Paper size
- Page margins
- Image size

Refer to your other software program's documentation for more information.

Step 1: Load the photo paper

- For best results, use photo paper that is made for inkjet printers. You can also use coated or glossy paper. You can load up to 25 sheets at a time, depending on the thickness of the paper.
- If your paper includes instructions, read them carefully.

- Load the photo paper vertically against the right side of the paper support.

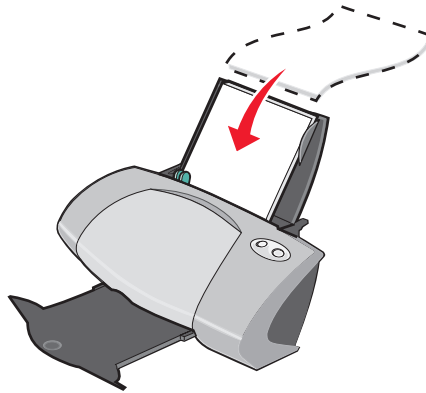

- Make sure the glossy or coated side is facing you.
- Do not force the paper into the printer.
- Squeeze and slide the paper guide to the left side of the photo paper.

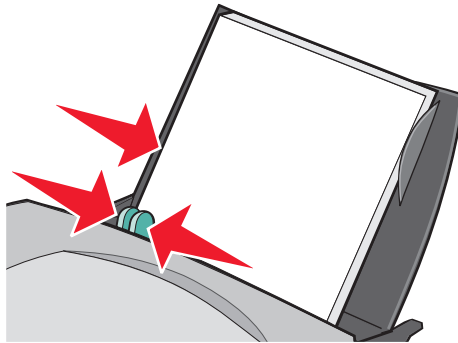

Note: If you are using letter size paper, adjusting the paper guide may not be necessary.

Step 2: Customize the print settings

- 1** With your document open, click **File** ▶ **Print**.
The Print dialog box appears.
- 2** From the Print dialog box, click **Properties**, **Preferences**, or **Options**.
- 3** Select a paper size:
 - a** From the Print Properties dialog box, select the **Paper Setup** tab.
 - b** From the Paper Size area, select:
 - **Borderless** if you want to print a borderless photo. The size of the paper you are using and the size of the photo you want to print must be the same.
 - **Paper** if you do not want the printer to print to the edges of the paper.

- c From the Paper Size menu, select the correct size. For more information about printing on custom size paper, see page 41.

4 Click **OK**.

Step 3: Print your photos

Click **OK**.

Note: To prevent smudging, remove each photo as it exits the printer, and then let it dry before stacking.

Printing on premium or coated paper

You can load up to 100 sheets of premium paper at a time, depending on the thickness of the paper.

Step 1: Load the premium paper

- If your paper includes instructions, read them carefully.
- Load the premium paper vertically against the right side of the paper support.

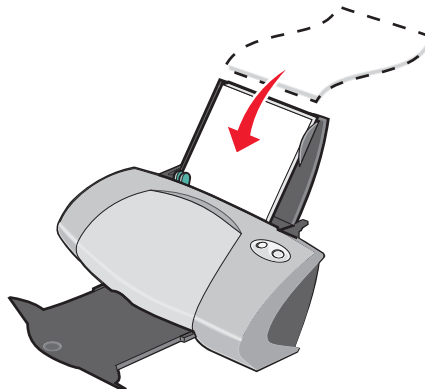

- If there is a special mark on the paper, make sure the mark is facing away from you.
- Do not force the paper into the printer.

- Squeeze and slide the paper guide to the left side of the paper.

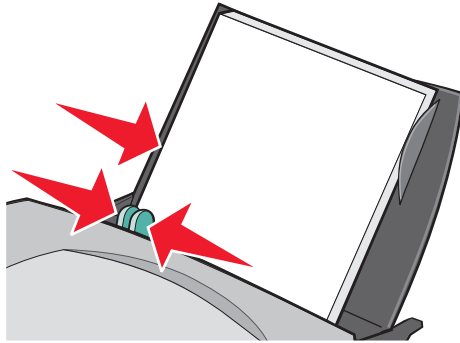

Note: If you are using letter size paper, adjusting the paper guide may not be necessary.

Step 2: Customize the print settings

- 1** With your document open, click **File** ▶ **Print**.
The Print dialog box appears.
- 2** From the Print dialog box, click **Properties**, **Preferences**, or **Options**.
- 3** Select a paper size:
 - a** From the Print Properties dialog box, select the **Paper Setup** tab.
 - b** From the Paper Size area, select **Paper**.
 - c** From the Paper Size menu, select the correct size. For more information about printing on custom size paper, see page 41.
- 4** Click **OK**.

Step 3: Print your document

Click **OK**.

Note: The paper exit tray holds up to 50 sheets of premium paper. If you want to print more than 50 pages, remove the first 50 sheets from the paper exit tray before you continue printing.

Printing on both sides of a sheet of paper

You can conserve paper by printing on both sides. Load up to 100 sheets of paper at a time, depending on the thickness of the paper.

Step 1: Load the paper

Note: For the best print quality, use a heavier weight paper.

- Load the paper vertically against the right side of the paper support.

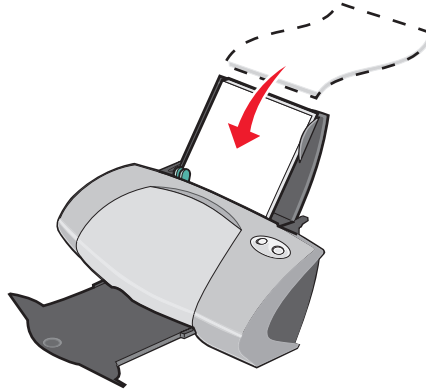

- Do not force the paper into the printer.
- Make sure the print side is facing you.
- Squeeze and slide the paper guide to the left side of the paper.

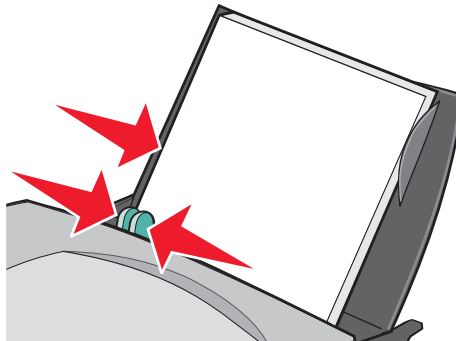

Note: If you are using letter size paper, adjusting the paper guide may not be necessary.

Step 2: Customize the print settings

- 1 With your document open, click **File** ▶ **Print**.
The Print dialog box appears.
- 2 From the Print dialog box, click **Properties**, **Preferences**, or **Options**.
- 3 Print on both sides of the page:
 - a From the Print Properties dialog box, select the **Print Layout** tab.
 - b From the Duplexing area, select **Two-Sided**.

- c Select **Side Flip** or **Top Flip**.

If you select **Side Flip**, the pages of your document turn like the pages of a magazine. If you select **Top Flip**, the pages turn like the pages of a legal pad.

- 4 Further customize your document following the steps for your paper type.
- 5 Click **OK**.

Step 3: Print your document

Click **OK**.

The odd-numbered pages print first, along with a reloading instruction page. When the odd-numbered pages finish printing, the printer software prompts you to reload the paper.

- 1 Load the stack of paper and reloading instruction page with the printed side facing away from you and the arrows pointing down into the paper support.

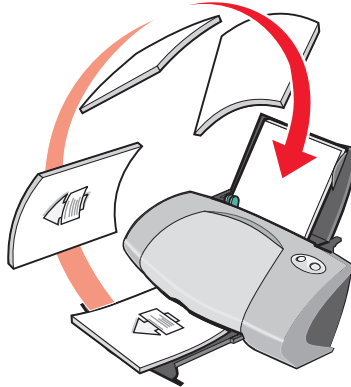

- 2 Click **Continue Printing**.

The even-numbered pages print.

If you do not want to print the reloading instruction page:

- 1 From the Print Properties dialog box, click **Options** ▶ **Style Options**.
- 2 Clear the **Print Instruction page to assist in reloading** check box.
- 3 Click **OK**.

Printing cards

You can load up to 25 greeting cards, index cards, photo cards, or postcards at a time, depending on the thickness of the cards.

Step 1: Load the cards

- If your cards include instructions, read them carefully.
- Load the cards vertically against the right side of the paper support.

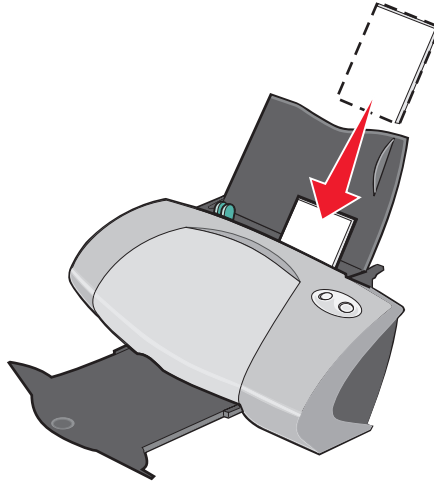

- Make sure the print side is facing you.
- Do not force the cards into the printer.
- Squeeze and slide the paper guide to the left side of the cards.



Step 2: Customize the print settings

- 1** With your document open, click **File** ▶ **Print**.
The Print dialog box appears.
- 2** From the Print dialog box, click **Properties**, **Preferences**, or **Options**.
- 3** Select a paper size:
 - a** From the Print Properties dialog box, select the **Paper Setup** tab.
 - b** From the Paper Size area, select:

- **Borderless** if you want to print a borderless photo. The size of the paper you are using and the size of the photo you want to print must be the same.
 - **Paper** if you do not want the printer to print to the edges of the paper.
- c From the Paper Size menu, select the correct size. For more information about printing on custom size paper, see page 41.

4 Click **OK**.

Step 3: Print your cards

Click **OK**.

Printing envelopes

You can load up to 10 envelopes at a time, depending on the thickness of the envelopes.

Step 1: Load the envelopes

Note: Do not use envelopes with holes, windows, deep embossing, metal clasps, string ties, or folding bars.

- Load the envelopes vertically against the right side of the paper support.

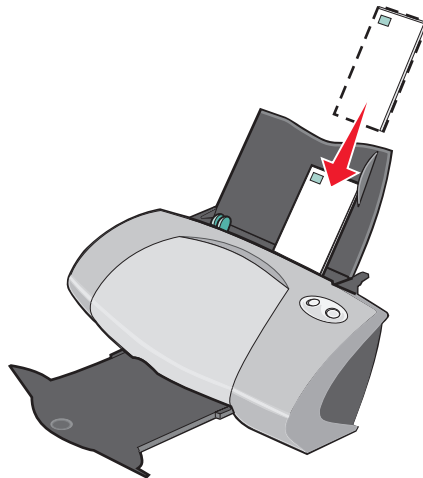

- Make sure the print side is facing you.
- Make sure the stamp location is in the upper left corner.
- Do not force the envelopes into the printer.

- Squeeze and slide the paper guide to the left side of the envelopes.



Step 2: Customize the print settings

- 1** With your document open, click **File** ▶ **Print**.
The Print dialog box appears.
- 2** From the Print dialog box, click **Properties**, **Preferences**, or **Options**.
- 3** Select an envelope size:
 - a** From the Print Properties dialog box, select the **Paper Setup** tab.
 - b** From the Paper Size area, select **Envelope**.
 - c** From the Envelope Size menu, select the correct size. For more information about printing on custom size paper, see page 41.
- 4** Select the orientation:
 - a** From the Print Properties dialog box, select the **Paper Setup** tab.
 - b** From the Orientation area, select **Landscape**.
- 5** Click **OK**.

Note: Many software programs are designed to override the settings in Paper Setup. Make sure landscape orientation is selected in your software program.

Step 3: Print your envelopes

Click **OK**.

Note: The paper exit tray holds up to 10 envelopes. If you want to print more than 10 envelopes, remove the first 10 from the paper exit tray before the others print.

Printing color images in black and white

You can load up to 100 sheets of paper at a time, depending on the thickness of the paper.

Printing color images in black helps to conserve ink in your color print cartridge.

Step 1: Load the paper

- Load the paper vertically against the right side of the paper support.

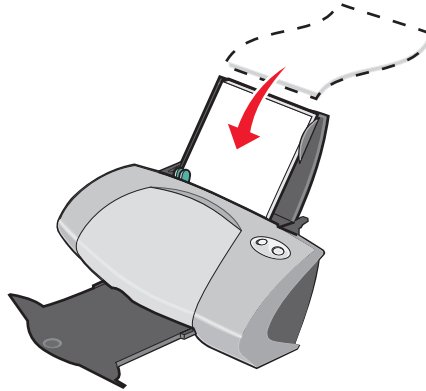

- Make sure the print side is facing you.
- Do not force the paper into the printer.
- Squeeze and slide the paper guide to the left side of the paper.

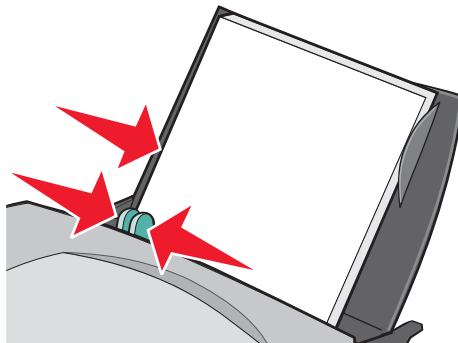

Note: If you are using letter size paper, adjusting the paper guide may not be necessary.

Step 2: Customize the print settings

- 1 With your document open, click **File** ▶ **Print**.
The Print dialog box appears.
- 2 From the Print dialog box, click **Properties**, **Preferences**, or **Options**.

- 3 To print color images in black and white:
 - a From the Print Properties dialog box, select the **Quality/Copies** tab.
 - b Select **Print Color Images in Black and White**.
- 4 Further customize your document following the steps for your paper type.
- 5 Click **OK**.

Step 3: Print your document

Click **OK**.

Note: The paper exit tray holds up to 50 sheets of plain paper. If you want to print more, remove the first 50 sheets from the paper exit tray before the others print.

Printing a booklet



You can print and bundle your document to make a booklet. You can load up to 100 sheets of paper at a time, depending on the thickness of the paper.

Step 1: Load the paper

- Load the paper vertically against the right side of the paper support.

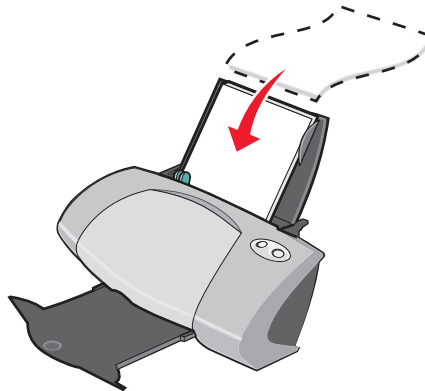

- Make sure the print side is facing you.
- Do not force the paper into the printer.

- Squeeze and slide the paper guide to the left side of the paper.

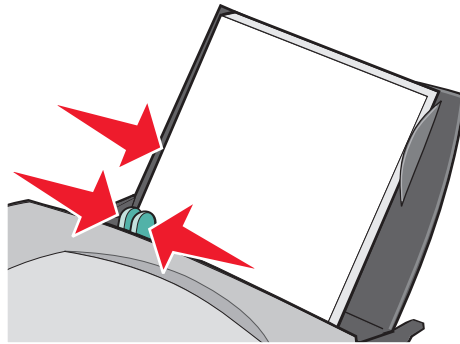

Note: If you are using letter size paper, adjusting the paper guide may not be necessary.

Step 2: Customize the print settings

- 1** With your document open, click **File** ▶ **Print**.
The Print dialog box appears.
- 2** From the Print dialog box, click **Properties**, **Preferences**, or **Options**.
- 3** Select a paper size:
 - a** From the Print Properties dialog box, select the **Paper Setup** tab.
 - b** From the Paper Size area, select **Paper**.
 - c** From the Paper Size menu, select **A4** or **Letter**.

- 4** Select a print layout:
 - a** From the Print Properties dialog box, select the **Print Layout** tab.
 - b** From the Layout area, select **Booklet**.
- 5** Enter the number of sheets per bundle.

Note: A bundle is a group of pages that are folded in half and stacked before binding. Very thick bundles may not fold well, so if you are printing with thick paper, use fewer printed sheets per bundle.

- a** From the Print Properties dialog box, click **Options** ▶ **Style Options**.
 - b** Enter the number of sheets you want in each bundle and then click **OK**.
- 6** Click **OK** to close the Print Properties dialog box.

Step 3: Print your document

Click **OK**.

After the first half of your booklet and the reloading instruction page prints, your printer software prompts you to reload the paper.

- 1 Insert the stack of paper and the reloading instruction page with the printed side facing away from you and the arrows pointing down into the paper support.

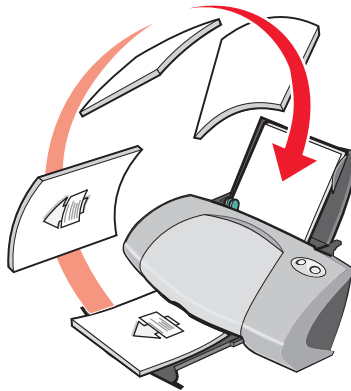

- 2 Click **Continue Printing**.

If you do not want to print the reloading instruction page:

- 1 From the Print Properties dialog box, click **Options** ▶ **Style Options**.
- 2 Clear the **Print instruction page to assist in reloading** check box.
- 3 Click **OK**.

Step 4: Build your booklet

After your document prints, stack the bundles together and bind your booklet.

To build your booklet:

- 1 Remove the first bundle from the paper exit tray, fold it in half, and set it aside.
- 2 Remove the next bundle, fold it in half, and then stack it on top of the first bundle.



- 3 Continue to stack the bundles on top of each other until your booklet is complete.

- 4 Bind the bundles to complete your booklet.



Printing labels

You can load up to 20 sheets of labels at a time, depending on the thickness of the sheets.

Step 1: Load the labels

- Use labels designed for inkjet printers.
- If your labels include instructions, read them carefully.
- Do not print within 1 mm (0.04 in.) of the edge of a label.
- Load the labels vertically against the right side of the paper support.

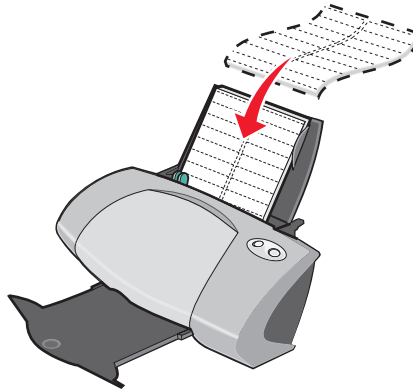

- Make sure there are no missing or curled labels.
- Make sure the print side is facing you.
- Do not force the labels into the printer.

- Squeeze and slide the paper guide to the left side of the labels.

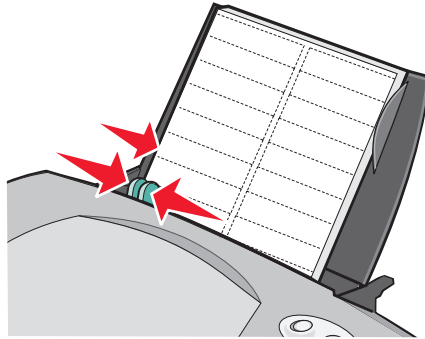

Note: If you are using letter size sheets of labels, adjusting the paper guide may not be necessary.

Step 2: Customize the print settings

- 1** With your document open, click **File** ▶ **Print**.
The Print dialog box appears.
- 2** From the Print dialog box, click **Properties**, **Preferences**, or **Options**.
- 3** Select a paper size:
 - a** From the Print Properties dialog box, select the **Paper Setup** tab.
 - b** From the Paper Size area, select **Paper**.
 - c** From the Paper Size menu, select the correct size. For more information about printing on custom size paper, see page 41.
- 4** Click **OK**.

Step 3: Print your labels

Click **OK**.

Note: The paper exit tray holds up to 10 sheets of labels. If you want to print more than 10 sheets, remove the first 10 sheets from the paper exit tray before the others print.

Printing handouts

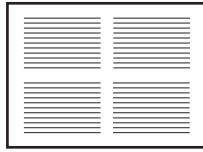

You can conserve paper by printing handouts, or multiple page images, on a single sheet of paper. Load up to 100 sheets of paper at a time, depending on the thickness of the paper.

Step 1: Load the paper

- Load the paper vertically against the right side of the paper support.

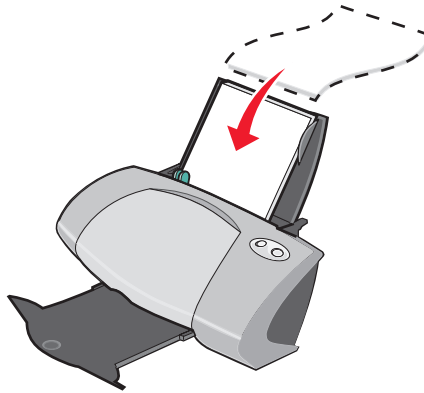

- Make sure the print side is facing you.
- Do not force the paper into the printer.
- Squeeze and slide the paper guide to the left side of the paper.



Note: If you are using letter size paper, adjusting the paper guide may not be necessary.

Note: For the best print quality, use a heavier weight paper.

Step 2: Customize the print settings

- 1** With your document open, click **File ▶ Print**.
The Print dialog box appears.
- 2** From the Print dialog box, click **Properties, Preferences, or Options**.
- 3** Select a print layout:
 - a** From the Print Properties dialog box, select the **Print Layout** tab.
 - b** From the Layout area, select **N-up**.
 - c** Select the number of pages (two, three, four, or eight) you want to print on a single sheet of paper.
 - d** If you want to print a border around each page image, select **Print Page Borders**.
- 4** To print on both sides of the paper:
 - a** From the Print Properties dialog box, select the **Print Layout** tab.
 - b** From the Duplexing area, select **Two-Sided**.
 - c** Select **Side Flip** or **Top Flip** binding.
If you select **Side Flip**, the pages of your document turn like the pages of a magazine. If you select **Top Flip**, the pages turn like the pages of a legal pad.
- 5** Click **OK**.

Step 3: Print your handouts

Click **OK**.

If you formatted your handouts to print on one side of the page, you are finished.

If you formatted your handouts to print on both sides of the page, continue printing your handouts.

- 1 After the first half of your handouts prints, your printer software prompts you to reload the paper. Insert the paper and reloading instruction page with the printed side facing away from you and the arrows pointing down into the paper support.

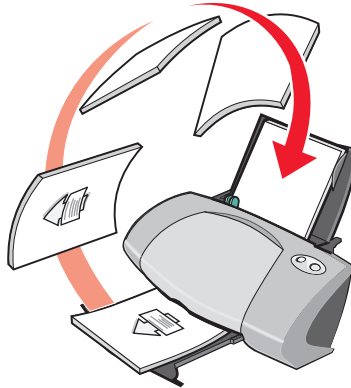

- 2 Click **Continue Printing**.

If you do not want to print the reloading instruction page:

- 1 From the Print Properties dialog box, click **Options** ▶ **Style Options**.
- 2 Clear the **Print instruction page to assist in reloading** check box.
- 3 Click **OK**.

Printing a poster

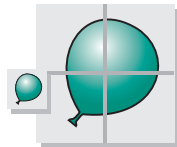

You can enlarge a single page image to print on multiple pages. For example, you can enlarge a photograph to print as a four-, nine-, or 16-page poster.

Print up to 100 sheets of paper at a time, depending on the thickness of the paper.

Step 1: Load the paper

- Load the paper vertically against the right side of the paper support.

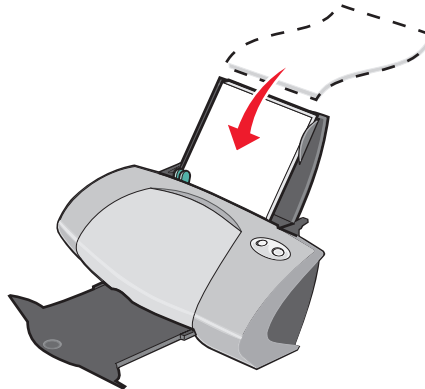

- Make sure the print side is facing you.
- Do not force the paper into the printer.
- Squeeze and slide the paper guide to the left side of the paper.

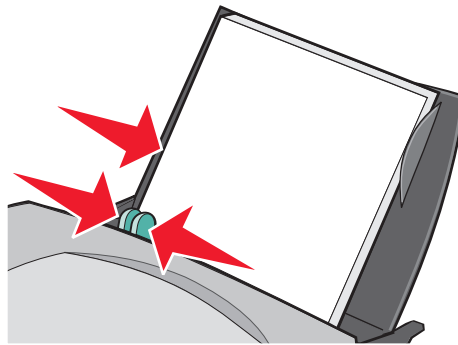

Note: If you are using letter size paper, adjusting the paper guide may not be necessary.

Note: For the best print quality, use a heavier weight paper.

Step 2: Customize the print settings

- 1 With your document open, click **File** ▶ **Print**.
The Print dialog box appears.
- 2 From the Print dialog box, click **Properties**, **Preferences**, or **Options**
- 3 Select a print layout:
 - a From the Print Properties dialog box, select the **Print Layout** tab.
 - b From the Layout area, select **Poster**.

- 4 Select your poster size:
 - a Select the size of your poster: **2 x 2** (four pages total), **3 x 3** (nine pages total), or **4 x 4** (16 pages total).
 - b Select **Print Crop Marks** if you want help cutting the edges of your pages.
- 5 If you need to reprint a selection of pages:
 - a Click **Select Pages To Print...**

The pages that are *not* going to print have a circle and a bar symbol over the number and are shaded. Select or clear each page by clicking it.
 - b Click **OK**.
- 6 Click **OK**.

Step 3: Print your poster

Click **OK**.

Assemble your poster

- 1 On each printed page, trim the white edges from two adjacent sides.
For example, trim the white edge from the top and left sides of each page.

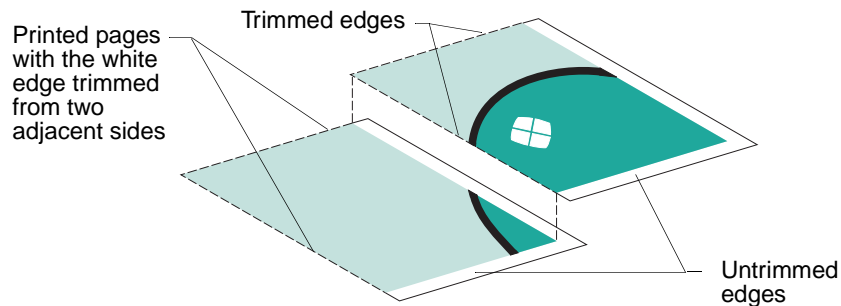

- 2 Arrange the pages so that every trimmed edge overlaps an untrimmed edge (the white edge).
- 3 Tape the backs of the pages together.
- 4 To complete your poster, trim any remaining white edges.

Printing iron-on transfers

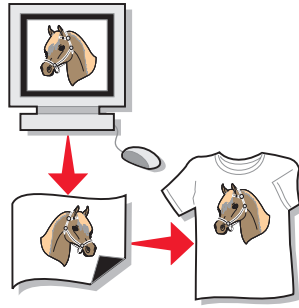

You can load up to 100 iron-on transfers at a time, depending on the thickness of the transfers. You may want to print on plain paper before loading your iron-on transfers.

Note: For best results, load one iron-on transfer at a time.

Step 1: Load the iron-on transfers

- If your iron-on transfers include instructions, read them carefully.
- Load the iron-on transfers vertically against the right side of the paper support.

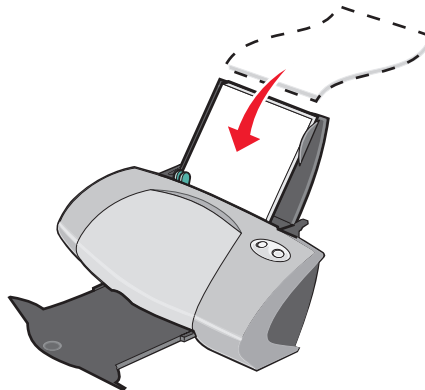

- Make sure the print side (blank side) is facing you.
- Do not force the iron-on transfers into the printer.

- Squeeze and slide the paper guide to the left side of the iron-on transfers.

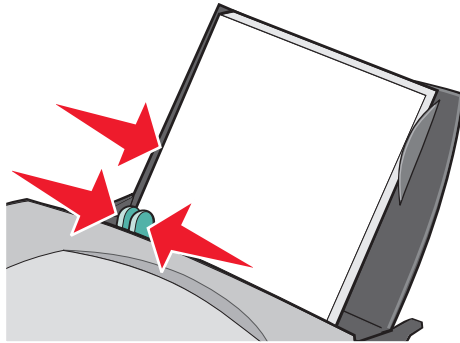

Note: If you are using letter size iron-on transfers, adjusting the paper guide may not be necessary.

Step 2: Customize the print settings

- 1 With your document open, click **File** ▶ **Print**.
The Print dialog box appears.
- 2 From the Print dialog box, click **Properties**, **Preferences**, or **Options**.
- 3 If your software program does not have mirror or iron-on settings, select a print layout:
 - a From the Print Properties dialog box, select the **Print Layout** tab.
 - b From the Layout area, select **Mirror**.
- 4 Click **OK**.

Step 3: Print your iron-on transfer

Click **OK**.

Note: To prevent smudging, remove each iron-on transfer as it exits the printer, and then let it dry before stacking.

Printing transparencies

You can load up to 20 transparencies at a time, depending on the thickness of the transparencies.

Step 1: Load the transparencies

- Use transparencies designed for inkjet printers.

- If your transparencies include instructions, read them carefully.
- Load the transparencies vertically against the right side of the paper support.

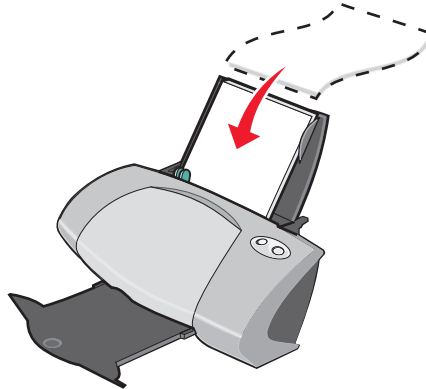

- Make sure the rough side (print side) of the transparencies is facing you. If the transparencies have a removable stripe, make sure each stripe is facing away from you and down toward the printer.
- Do not force the transparencies into the printer.
- Squeeze and slide the paper guide to the left side of the transparencies.

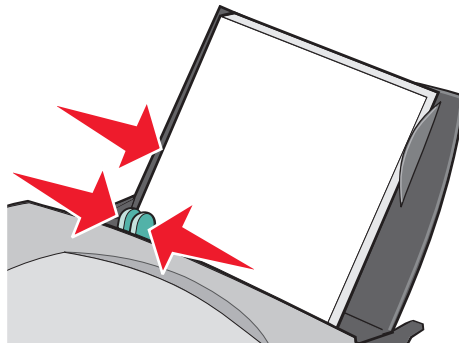

Note: If you are using letter size transparencies, adjusting the paper guide may not be necessary.

Step 2: Customize the print settings

- 1** With your document open, click **File** ▶ **Print**.
The Print dialog box appears.
- 2** From the Print dialog box, click **Properties**, **Preferences**, or **Options**.
- 3** Select a paper size:
 - a** From the Print Properties dialog box, select the **Paper Setup** tab.
 - b** From the Paper Size area, select **Paper**.

c From the Paper Size menu, select **A4** or **Letter**.

4 Click **OK**.

Step 3: Print your transparencies

Click **OK**.

Note: To prevent smudging, remove each transparency as it exits the printer, and then let it dry before stacking.

Printing your document in reverse order

You can load up to 100 sheets of paper at a time, depending on the thickness of the paper.

Step 1: Load the paper

- Load the paper vertically against the right side of the paper support.

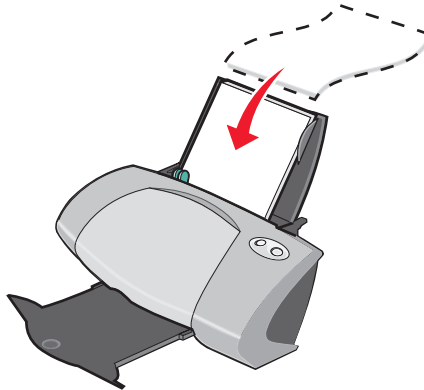

- Make sure the print side is facing you.
- Do not force the paper into the printer.

- Squeeze and slide the paper guide to the left side of the paper.

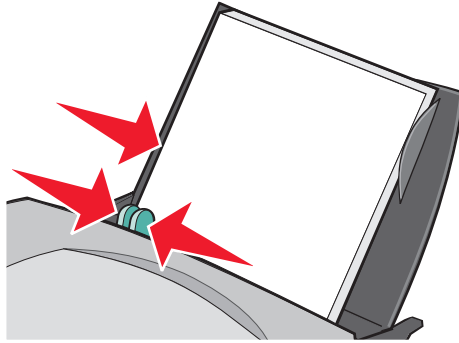

Note: If you are using letter size paper, adjusting the paper guide may not be necessary.

Step 2: Customize the print settings

- 1** With your document open, click **File** ▶ **Print**.
The Print dialog box appears.
- 2** From the Print dialog box, click **Properties**, **Preferences**, or **Options**.
- 3** To print the last page first:
 - a** From the Print Properties dialog box, select the **Quality/Copies** tab.
 - b** Select **Print Last Page First**.
- 4** Follow the steps for your paper type to further customize your document.
- 5** Click **OK**.

Step 3: Print your document

Click **OK**.

Note: The paper exit tray holds up to 50 sheets of plain paper. If you want to print more, remove the first 50 sheets from the paper exit tray before the others print.

Printing a banner

You can load up to 20 sheets of banner paper at a time.

Step 1: Load the banner paper

- 1 Remove any paper from the printer.

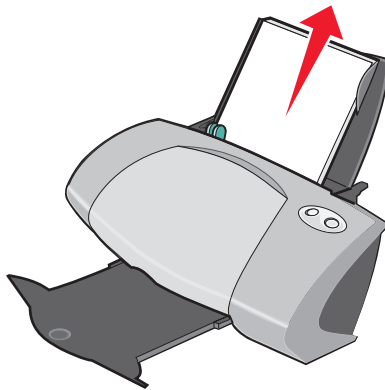

- 2 Place a stack of banner paper with *only* the number of sheets you need to print your banner behind the printer.

Note: Loading excess banner paper may cause a paper jam. For help, see “Printer has a paper jam” on page 60.

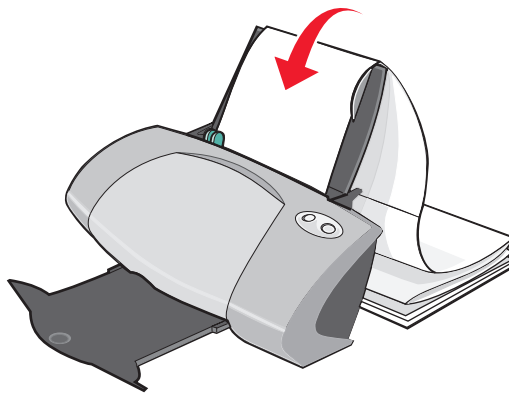

- 3 Load the leading edge of the banner paper into the printer against the right side of the paper support.

- 4 Squeeze and slide the paper guide to the left edge of the banner paper.

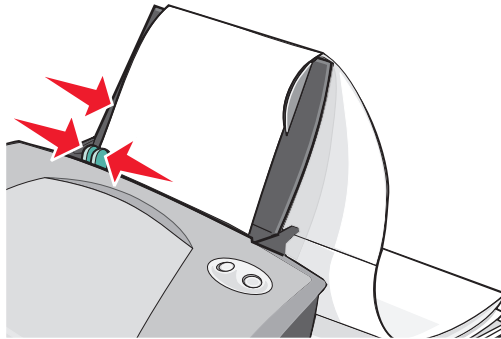

Note: If you are using letter size banner paper, adjusting the paper guide may not be necessary.

Step 2: Customize the print settings

- 1 With your document open, click **File** ▶ **Print**.
The Print dialog box appears.
- 2 From the Print dialog box, click **Properties**, **Preferences**, or **Options**.
- 3 Select a banner size:
 - a From the Print Properties dialog box, select the **Paper Setup** tab.
 - b From the Paper Size area, select **Banner**.
 - c From the Banner Size menu, select **A4** or **Letter**.
- 4 Select the orientation:
 - a From the Print Properties dialog box, select the **Paper Setup** tab.
 - b From the Orientation area, select **Portrait** or **Landscape**.
- 5 Select a print layout:
 - a From the Print Properties dialog box, select the **Print Layout** tab.
 - b From the Layout area, select **Banner**.
- 6 Click **OK**.

Step 3: Print your banner

Click **OK**.

Printing on custom size paper

You can load up to 100 sheets of custom size paper at a time, depending on the thickness of the paper.

Step 1: Load the custom size paper

- Make sure your paper size fits within these dimensions:
 - Width: 76 to 216 mm (3 to 8.5 in.)
 - Length: 127 to 432 mm (5 to 17 in.)
- Load the paper vertically against the right side of the paper support.

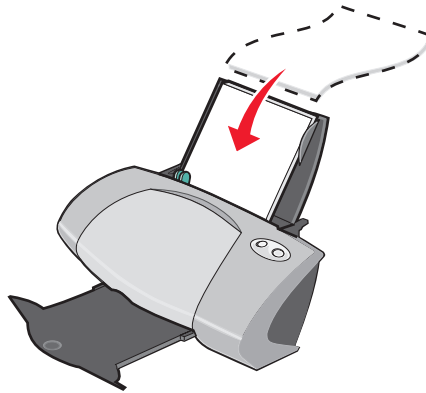

- Make sure the print side is facing you.
- Do not force the paper into the printer.
- Squeeze and slide the paper guide to the left side of the paper.

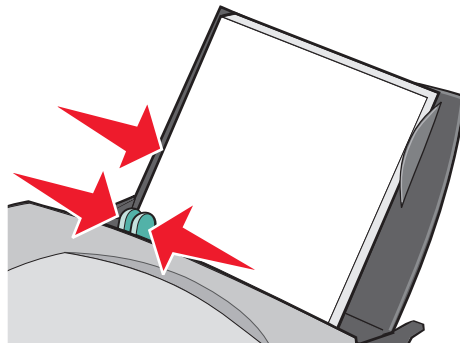

Step 2: Customize the print settings

- 1 With your document open, click **File** ▶ **Print**.

The Print dialog box appears.

- 2** From the Print dialog box, click **Properties**, **Preferences**, or **Options**.
- 3** Create a custom paper size:
 - a** From the Print Properties dialog box, select the **Paper Setup** tab.
 - b** From the Paper Size menu, select **Custom Size**.
A dialog box displays on the screen.
 - c** From the Units area, select **Millimeters** or **Inches**.
 - d** Type the dimensions for your custom paper size.
 - e** Click **OK**.
- 4** Continue to customize your document based on your paper type.

Step 3: Print your document

Click **OK**.

3

Maintenance

Replacing the print cartridges

The Lenovo 5110-6110 uses the following cartridges:

Left cartridge carrier: Lexmark Color cartridge only	Right cartridge carrier: Lexmark Black or Photo cartridge only
19	48
20	50
25	55
	90 (photo)

Note: You can use the printer with just a color cartridge or just a black cartridge. You must have a color cartridge installed when you print with a photo cartridge.

For information about ordering supplies, see page 50.

Removing the used cartridges

- 1 Make sure the power light is on.
- 2 Raise the front cover.

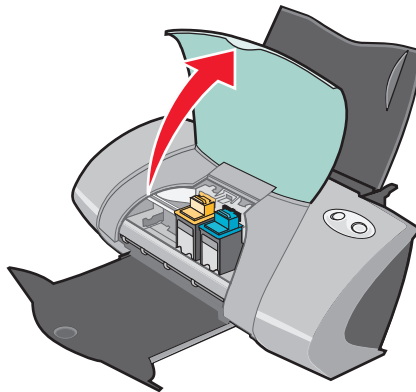

The cartridge carrier moves to the loading position, unless the printer is busy.

- 3 Pull the cartridges toward you until you hear a *snap*.

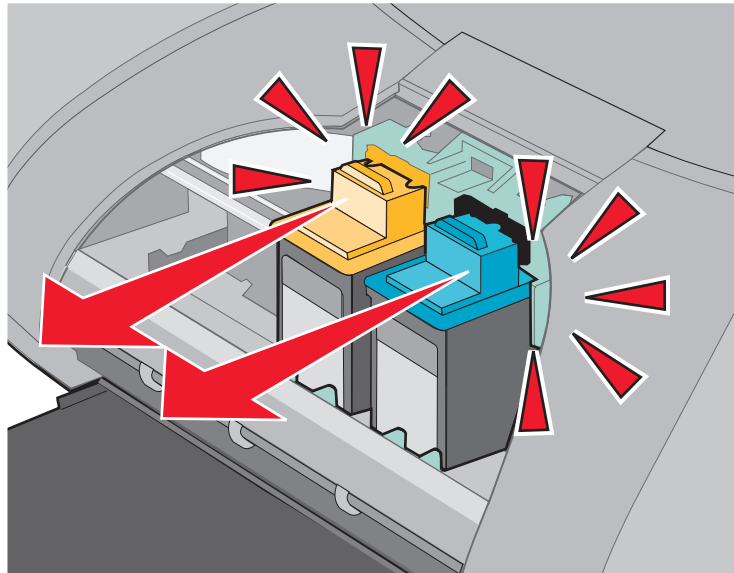

- 4 Remove the used cartridges. Store them in an airtight container or dispose of them properly.

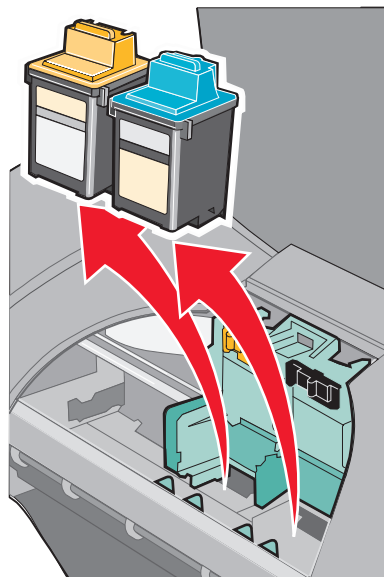

Installing the cartridges

- 1 If you are installing new cartridges, remove the sticker and transparent tape from the back and bottom of the cartridges

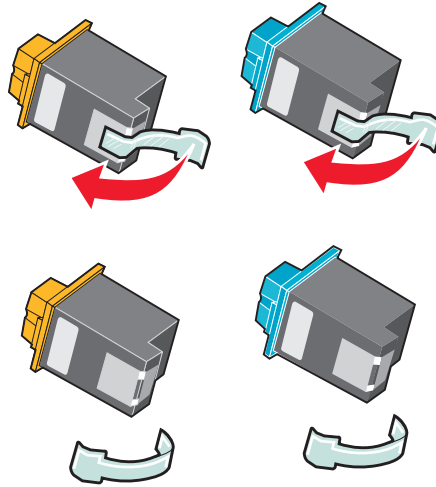

Warning: Do *not* touch or remove the gold contact areas on the back and bottom of the cartridges.

- 2 Insert the color cartridge in the left carrier. Insert the black or photo cartridge in the right carrier. Depending on the part numbers you use, the color of the cartridge tops may vary.

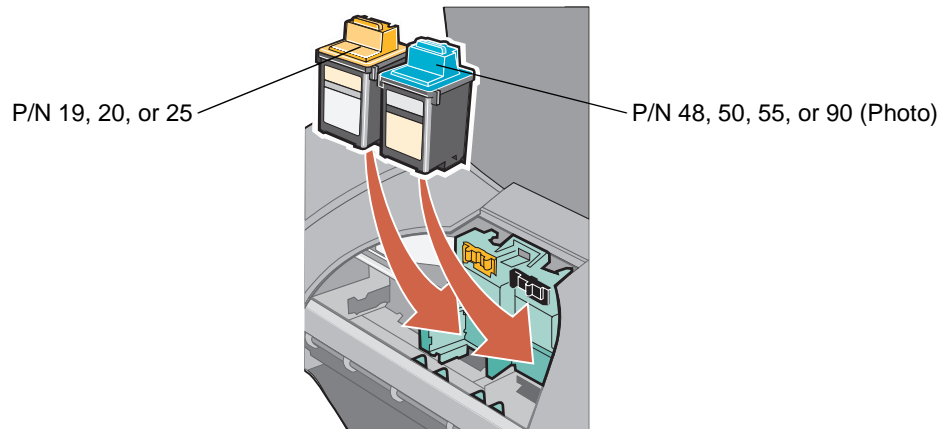

Note: To extend the life of your color cartridge and improve printing speed, install a black or photo cartridge along with the color cartridge.

- 3 Snap the cartridges into place.

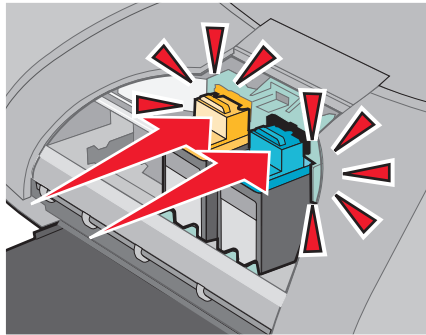

- 4 Close the front cover.

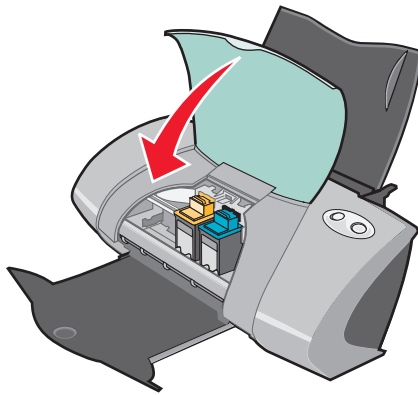

Note: The front cover must be closed to start a print job.

Specifying cartridge settings in the printer software

Before you specify the print cartridge settings in the printer software, install the cartridges. For help, see “Installing the cartridges” on page 45.

- 1 Open the LSC. For help, see “Lenovo Solution Center” on page 11.
- 2 From the Maintenance tab, click **Install a new print cartridge**.
- 3 Select the type of cartridge you installed.

Note: Specify whether the cartridge is a new cartridge or an old cartridge (one that has been used before). If an old cartridge is incorrectly identified as New Cartridge in the Lenovo Solution Center, ink levels may be incorrect.

- 4 Click **OK** or **Next**.
- 5 If you installed a new cartridge, continue with “Aligning the print cartridges.”

Aligning the print cartridges

Typically, you only align print cartridges after installing or replacing a cartridge. However, you may also need to align cartridges when:

- Characters are not properly formed or are not aligned at the left margin.
- Vertical, straight lines are wavy.

To align the cartridges:

- 1 Load plain paper.
- 2 Open the Lenovo Solution Center. For help, see page 11.
- 3 From the Maintenance tab, click **Align to fix the blurry edges**.
- 4 Click **Print**.

The Alignment page prints.

If you have to manually align the cartridges, you must select the best alignment values from the printed page.

- a Find the number under the darkest arrow for each alignment group.
- b Use the arrows in the Align Cartridges dialog box to select the number that matches the darkest arrow on the printed page for each alignment group.
- c Click **OK**.

If the alignment page does not print, make sure you have completely removed the sticker and transparent tape from both cartridges. For help, see page 45.

Improving print quality

If you are not satisfied with the print quality of your document, make sure you:

- Use the appropriate paper for the document. For example, use photo paper if you are printing a photo.
- Use paper that is a heavier weight, bright white, or coated.
- Select a higher print quality:

- 1 From your software program, click **File** ▶ **Print**.

The Print dialog box appears.

- 2 From the Print dialog box, click **Properties**, **Preferences**, or **Options**.
- 3 From the Quality/Speed area, select **Better** or **Best**.

If your document still does not have the print quality you want, follow these steps:

1 Reinsert the print cartridges:

- a** Remove the print cartridges. For help, see page 43.
- b** Insert the print cartridges. For help, see page 45.
- c** Print your document again.
- d** If print quality has not improved, continue with step 2.

2 Clean the print nozzles:

- a** Load paper. For help, see page 13.
- b** Open the Lenovo Solution Center. For help, see page 11.
- c** Click the **Maintenance** tab.
- d** From the Maintenance tab, click **Clean to fix horizontal streaks**.
- e** Click **Print**.

A nozzle page prints, forcing ink through the nozzles to clean the clogged nozzles.

- f** Print your document again to verify that your print quality has improved.
- g** If you are not satisfied with your print quality, continue with step 3, and then print your document again.

3 Wipe the print cartridge nozzles and contacts:

- a** Remove the print cartridges. For help, see page 43.
- b** Dampen a clean, lint-free cloth with water.
- c** Gently hold the cloth against the nozzles for about three seconds, and then wipe in the direction shown.

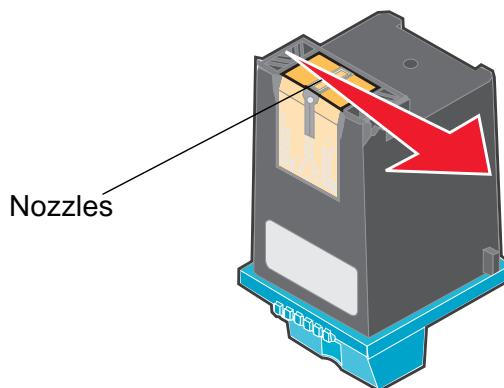

- d** Using another clean section of the cloth, gently hold the cloth against the contacts for about three seconds, and then wipe in the direction shown.

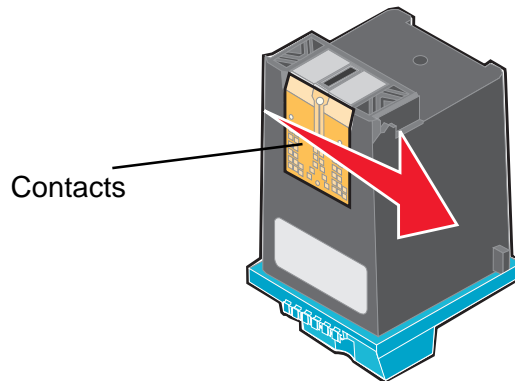

- e** With another clean section of the cloth, repeat step c through d.
- f** Allow the nozzles and contacts to dry completely.
- g** Reinsert the print cartridges.
- h** Print your document again.
- i** If the print quality does not improve, repeat step 3 up to two more times.
- j** If print quality is still not satisfactory, replace the print cartridges. For information, see “Ordering supplies” on page 50.

Preserving the print cartridges

To ensure the longest life from your print cartridges and optimum performance from your printer:

- Keep a new cartridge in its packaging until you are ready to install it.
- Keep your photo cartridge in the print cartridge storage unit when not in use. A print cartridge storage unit is included with new photo print cartridges.
- Do not remove a print cartridge from the printer except to replace, clean, or store it in an airtight container. The print cartridges do not print correctly if left exposed for an extended period.

Lenovo’s printer warranty does not cover repair of failures or damage caused by a refilled cartridge. We do not recommend use of refilled cartridges. Refilling cartridges can affect print quality and cause damage to the printer. For best results, use Lexmark supplies.

Ordering supplies

To order supplies or locate a dealer near you, contact the Lenovo Web site at www.lenovo.com.

Item:	Part number:
Black cartridge	48 50 55
Color cartridge	19 20 25
Photo cartridge	90
USB cable	12A2405

4

Setup troubleshooting

Troubleshooting checklist

- Is the power supply firmly attached to your printer and a properly grounded electrical outlet?
- Are both your printer and computer on?
- Is your USB cable securely attached to your printer and computer?
- Are any printer lights blinking? For help, see “Understanding error messages and flashing lights” on page 55.
- Did you remove the sticker and transparent tape from the back and bottom of both print cartridges?
- Did you install the print cartridges correctly? For help, see page 45.
- Is the paper loaded correctly? Make sure you do not push the paper too far into the printer. For help, see page 13.
- Did you install the printer software correctly?

From your desktop, click **Start ▶ Programs** or **All Programs**.

If Lenovo 5110-6110 does not appear in your list of programs, install the printer software.

- Is the printer set as the default printer?
- To set the printer to be the default printer:
- 1 Click **Start** ▶ **Settings** ▶ **Printers**
 - 2 Right-click the **Lenovo 5110** and make sure that **Set as Default** is selected.
- Is your printer connected directly to your computer through an external device, such as a USB hub, switch box, scanner, or fax machine? If it is, follow these steps:
- 1 Disconnect your printer from any external devices.
 - 2 Connect your printer directly to your computer with a USB cable.
 - 3 Follow these instructions to print a test page.
 - a Open the Lenovo Solution Center. For help, see page 11.
 - b From the Maintenance tab, click **Print a Test Page**.
 - If the test page prints, the problem may be with your external devices, not your printer. Check the documentation that came with your external devices for help.
 - If the test page does not print, refer to the printer software Help for further troubleshooting information.

Solving printer software installation problems

If the printer software does not install properly, a communications error message appears when you try to print. You may need to remove the printer software, and then reinstall it.

When I insert the printer software CD, nothing happens.

- 1 Close all open software programs.
- 2 Restart your computer.

- 3 Click **Cancel** on all screens similar to the following that appear.

Windows 98/Me



Windows 2000/XP

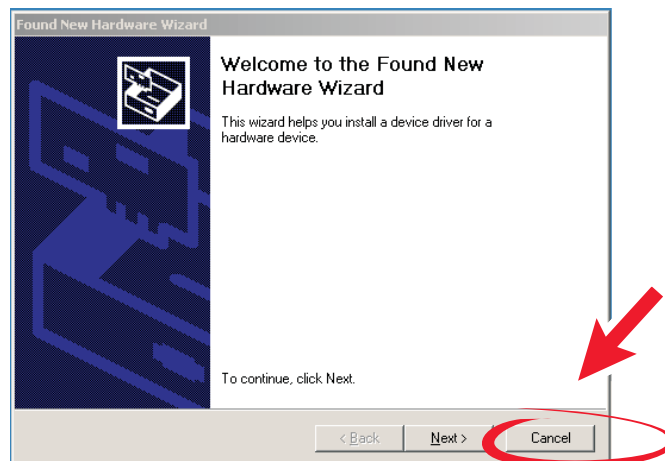

- 4 Eject and reinsert the printer software CD.
- 5 From your desktop, double-click **My Computer**.
- 6 Double-click your **CD-ROM drive icon**. If necessary, double-click **setup.exe**.
- 7 Follow the instructions on your screen to complete printer software installation.

Removing the printer software

- 1** From your desktop, click **Start ▶ Programs ▶ Lenovo 5110-6110 ▶ Uninstall Lenovo 5110-6110**.
- 2** Follow the instructions on your screen to remove the printer software.
- 3** Restart the computer before reinstalling the printer software.

Installing the printer software

You can install the printer software using the printer software CD that came with your printer, or you can download it from the Lenovo Web site at www.lenovo.com.

Using the CD that came with your printer

- 1** Close all open software programs.
- 2** When your desktop appears, insert the printer software CD.
The Lenovo Installer screen appears.
- 3** Click **Install**.
- 4** Follow instructions on your screen to complete printer software installation.
A printer icon is automatically created on your desktop.

Using the World Wide Web

- 1** From the Lenovo Web site, www.lenovo.com, select the appropriate driver for your operating system.
- 2** Follow the instructions on your screen to install the printer software.

5

General troubleshooting

For information about:	See page:
Understanding error messages and flashing lights	55
Resolving unsuccessful or slow printing	57
Clearing paper misfeeds or jams	59
Solving print quality problems	60
Solving specialty media problems	63

Understanding error messages and flashing lights

Use this section to understand printer software error messages on your computer screen and blinking lights on your printer.

Paper Jam message

For help clearing a paper jam, see “Printer has a paper jam” on page 60.

Ink Low message

A print cartridge is running out of ink. An Ink Low message appears when one of your cartridges is 25% full or less.

When this message appears you can:

- Click **OK**.

- Click the ? to get more information about ordering supplies.
- Order a new cartridge or locate a dealer near you by contacting the Lenovo Web site at www.lenovo.com.

For help:

- Installing a new cartridge, see page 45.
- Ordering supplies, see “Ordering supplies” on page 50.

The paper feed light is blinking

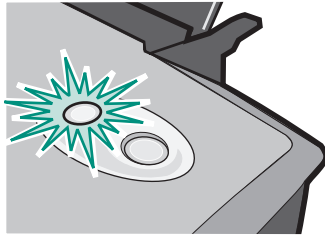

If the printer is out of paper:

- 1 Load paper.
- 2 Press the **paper feed** button.

If the printer has a paper jam, see page 60.

The power light is blinking

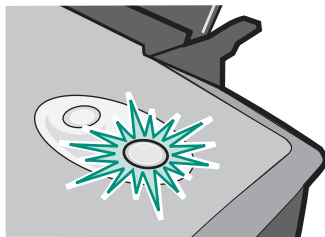

The print cartridge carrier is stalled.

- 1 Check your computer screen for error messages.
- 2 Turn the printer off.
- 3 Wait a few seconds, and then turn the printer back on. For more help, see “Clearing paper misfeeds or jams” on page 59.

Resolving unsuccessful or slow printing

The following topics can help you improve unsuccessful or slow printing.

Printer is plugged in, but does not print

For help, first see the troubleshooting checklist on page 51, and then:

Check the printer status:

Windows 98/Me/2000	Windows XP
<ol style="list-style-type: none"> 1 Click Start ▶ Settings ▶ Printers. 2 From the Printers folder, double-click the Lenovo 5110-6110 printer icon. 3 From the Printer menu, make sure: <ul style="list-style-type: none"> • Set as Default is selected. • Pause Printing is not selected. 	<ol style="list-style-type: none"> 1 Click Start ▶ Control Panel. 2 Click Printers and Other Hardware. 3 Click View installed printers or fax printers. 4 From the Printers folder, make sure there is a check next to the Lenovo 5110-6110 printer icon (indicating that it is the default printer). If there is no check, right-click the icon, and then click Set as Default Printer. 5 From the Printer menu, make sure that Pause Printing is not selected.

- Check the printer port:

Windows 98/Me	Windows 2000	Windows XP
<ol style="list-style-type: none"> 1 Click Start ▶ Settings ▶ Printers. 2 Right-click the Lenovo 5110-6110 printer icon, and then click Properties. 3 Click the Details tab. 4 From the Ports drop-down menu, check the printer port. If the USB port is <i>not</i> listed, remove, and then reinstall the printer software. 5 Click OK. 	<ol style="list-style-type: none"> 1 Click Start ▶ Settings ▶ Printers. 2 Right-click the Lenovo 5110-6110 printer icon, and then click Properties. 3 Click the Ports tab. 4 From the list of ports, select USB printer port. If the USB port is <i>not</i> listed, remove, and then reinstall the printer software. 5 Click Apply. 6 Click OK. 	<ol style="list-style-type: none"> 1 Click Start ▶ Control Panel ▶ Printers and Other Hardware ▶ Printers and Faxes. 2 Right-click the Lenovo 5110-6110 printer icon, and then click Properties. 3 Click the Ports tab. 4 From the list of ports, select USB printer port or Virtual printer port for USB. If the USB port is <i>not</i> listed, remove, and then reinstall the printer software. 5 Click Apply. 6 Click OK.

- Make sure you have not installed multiple copies of the printer software:
 - 1 Windows 98/Me/2000:** Click **Start** ▶ **Settings** ▶ **Printers**.
Windows XP: Click **Start** ▶ **Control Panel** ▶ **Printers and Other Hardware** ▶ **Printers and Faxes**.
 - 2** In the **Printers** folder, make sure there is only one **Lenovo 5110-6110** printer icon.
- If you have installed multiple copies of the printer software, remove each copy, and then restart the computer and reinstall the printer software.
- If the printer port is incorrect, remove, and then reinstall the printer software.

After you check these items, print a test page. For help, see page 52.

Test page does not print

For help, first see the troubleshooting checklist on page 51, and then:

- If the paper is jammed, see “Printer has a paper jam” on page 60.
- Try printing your test page again. If it still does not print, see:
 - “Resolving unsuccessful or slow printing” on page 57
 - “Solving printer software installation problems” on page 52

Alignment page does not print

Make sure:

- You completely removed the transparent tape and sticker from the back and bottom of the print cartridges. For help, see page 45.
- You installed the cartridges correctly. For help, see page 45.
- You loaded the paper correctly and did not force the paper into the printer.

Printer ejects a blank page after appearing to print

Make sure:

- You removed the sticker and transparent tape from the back and bottom of the print cartridges. For help, see page 45.
- Your cartridge does not have clogged nozzles. Clean the print cartridge nozzles and contacts. For help, see page 47.

Printer prints very slowly

- Close any software programs not in use.
- Check the document you are printing. Photos and graphics may take longer to print than regular text. Documents that are large or that contain background images may also take longer to print.
- Check the printer to see if another document is being printed. Print jobs are printed in the order the printer receives them.
- Decrease the print quality setting to **Normal** or **Quick Print**.

Note: Higher print quality settings result in better quality documents, but may take longer to print.

Clearing paper misfeeds or jams

The following topics can help you clear paper misfeeds or jams.

Paper misfeeds or multiple sheets feed

Make sure:

- Your paper is recommended for inkjet printers.
- The edges of your paper are not curled.
- A piece of paper from a previous print job is not jammed in the printer.
- You do not load too much paper. Depending on the weight of the paper, you can load up to 100 sheets of plain paper, 20 transparencies or labels, 10 envelopes, or 25 cards.
- You do not force the paper into the printer. For example, A4 paper should extend slightly beyond the top of the paper support and letter size paper should align with the top of the paper support.
- The paper guide is against the left edge of the paper.
- The paper guide does not cause the paper to bow.
- The printer is on a flat, level surface.
- The printer settings you have chosen are correct for the type of document you are printing. For help, see “Printing ideas” on page 13.
- The paper is against the right side of the paper support.

Printer does not feed envelopes or specialty media

Make sure:

- Your printer feeds paper without problems.
- Load the envelopes or specialty media vertically against the right side of the paper support. Squeeze and slide the paper guide to the left edge of the envelopes or specialty media. For help, see “Printing ideas” on page 13.
- You select the appropriate envelope or specialty media size and the appropriate paper type.
- You are using a specialty media or envelope size supported by your printer.
- Your software program is designed to print envelopes. For help, check your software program documentation.
- The envelope or specialty media is not jammed. For help, see “Printer has a paper jam” on page 60.

Printer has a paper jam

If the paper is lodged too far into the printer and cannot be removed:

- 1 Turn the printer off.
- 2 Turn the printer back on.

If the printer does not automatically eject the page:

- a Turn the printer off.
- b Pull firmly on the paper to remove it.

If you cannot reach the paper, raise the front cover, pull the paper out, and then close the front cover.

- c Turn the printer on.

Note: Do not force the paper into the printer.

Solving print quality problems

If print quality is unsatisfactory, you may need to adjust your margin settings, select a higher print quality, align the print cartridges, or clean the nozzles.

The following topics can help you improve an unsatisfactory document.

Print is too dark or smudged

- Make sure the paper is straight and not wrinkled.
- Let the ink dry completely before handling the paper.
- Make sure the paper type and paper size settings in the printer software match the paper loaded in the printer. For help, see page 8.

- Make sure the print quality setting is appropriate for the paper type.
- Clean the print cartridge nozzles and contacts. For help, see “Improving print quality” on page 47.

Vertical straight lines are not smooth

To improve the print quality of vertical straight lines in tables, borders, and graphs:

- Select a higher print quality.
- Align the print cartridges. For help, see “Aligning the print cartridges” on page 47.
- Clean the print cartridge nozzles and contacts. For help, see “Improving print quality” on page 47.

Print smears on the page

- The next page exiting the printer may be smearing the ink. Remove each page as it exits the printer and let it dry completely before stacking.
- Clean the print cartridge nozzles and contacts. For help, see “Improving print quality” on page 47.

Printed pages have alternating bands of light and dark print (intermittent printing)

Select a higher print quality. For help, see page 8.

Characters are missing or unexpected

- Make sure the Lenovo printer is selected as the default printer.
- Clean the print cartridge nozzles and contacts. For help, see “Improving print quality” on page 47.

If you do not want to print a borderless document, your margins must fall within these settings:

Margin:	Minimum setting:
Left and right	<ul style="list-style-type: none"> • 6.35 mm (0.25 in.) for U.S. Letter, U.S. Legal, Banner Letter, and custom paper sizes • 3.175 mm (0.125 in.) for envelopes • 3.37 mm (0.13 in.) for most paper sizes
Top	<ul style="list-style-type: none"> • 1.7 mm (0.067 in.)
Bottom	<ul style="list-style-type: none"> • 12.7 mm (0.5 in.) for black print jobs • 19 mm (0.75 in.) recommended for color print jobs

Printed characters are improperly formed or misaligned

- Cancel all print jobs and print your job again. To cancel all print jobs:
 - 1 Click **Start** ▶ **Settings** ▶ **Printers**.
 - 2 Double-click your **printer icon**.
 - 3 Select the document you want to cancel.
 - 4 From the **Document menu**, click **Cancel**.
- Repeat steps 3 through 4 for all the documents you want to cancel.
- Align the print cartridges. For help, see “Aligning the print cartridges” on page 47.
- Clean the print cartridge nozzles and contacts. For help, see “Improving print quality” on page 47.

Colors on the printout differ from the colors on the screen

- A cartridge may be low on ink. Check the ink levels in the Lenovo Solution Center. For help, see “Lenovo Solution Center” on page 11.
- Use a different paper brand. Each paper brand accepts ink differently and prints with color variations.

Select Natural Color as the document color:

- 1 With your document open, click **File** ▶ **Print**.
The Print dialog box appears.
- 2 From the Print dialog box, click **Properties**, **Preferences**, or **Options**.
- 3 Click **Options** ▶ **Quality Options**.
- 4 Click **Select color settings manually**.
- 5 Select **Natural Color**.

Colors on the printout are faded

Try the suggestions listed in the section “Colors on the printout differ from the colors on the screen” on page 62. If the colors still seem faded, clean the print cartridge nozzles and contacts. For help, see “Improving print quality” on page 47.

Photos do not print as expected

- Use a photo paper designed for inkjet printers.
- Select a higher print quality.

- Select photo paper as the paper type.
- Print a borderless document:
 - 1 With your document open, click **File** ▶ **Print**.
The Print dialog box appears.
 - 2 From the Print dialog box, click **Properties**, **Preferences**, or **Options**.
 - 3 From the Print Properties dialog box, select the **Paper Setup** tab.
 - 4 From the Paper Size area, select **Borderless**.
 - 5 From the Paper Size menu, select the correct size.
 - 6 From the Print Properties dialog box, click **OK**.
 - 7 From the Print dialog box, click **OK**.

Solving specialty media problems

The following topics can help solve problems with specialty media.

Glossy or photo papers or transparencies stick together

- Load one sheet of photo paper or transparencies at a time.
- Use a photo paper or transparency designed for inkjet printers.
- Make sure you loaded the paper correctly (with print side facing you) and selected the appropriate settings in the printer software. For help, see “Printing photos” on page 14 or “Printing transparencies” on page 35.
- Remove each page as it exits the printer, and then let it dry completely before stacking.

Transparencies or photos contain white lines

- Make sure you loaded the paper correctly (with print side facing you) and selected the appropriate settings in the printer software. For help, see “Printing transparencies” on page 35 or “Printing photos” on page 14.
- Select a higher print quality, such as **Better** or **Best**.
- Clean the print cartridge nozzles and contacts. For help, see “Improving print quality” on page 47.

Service station in China

省份	城市	维修站名称	通讯地址	通讯邮编	服务咨询电话
安徽省	合肥市	合肥联星电脑技术服务有限公司	合肥市屯溪路 120 号省地矿局大门西侧	230009	0551-4653222-12
安徽省	芜湖市	芜湖市环联电脑有限公司	皖芜湖市九华中路 326 号	241000	0553-3829207
安徽省	合肥市	合肥佳维电脑技术服务有限责任公司	合肥荣事达大道 93 号	230001	0551-2615660
安徽省	蚌埠市	北京金色快车计算机技术有限公司蚌埠分公司	安徽省蚌埠市胜利路 21 号 (地税大厦一楼)	233008	0552-2049920
北京市	北京市	联想 (北京) 有限公司北京客户服务部	北京市西城区新街口外大街 2 号有研大厦一层	100088	010-82015080-601/602
福建省	福州市	福州计通信息技术有限公司	福州市湖东路 82 号闽江工程局综合大楼一楼	350003	0591-7802979
福建省	厦门市	厦门市新四美达科技发展有限公司	厦门湖滨南路 128 号“联想服务”店面	361006/361004 (手持)	0592-2228383
福建省	泉州市	泉州科达电脑有限公司	泉州市九一路龙宫 D 座 106 号	362000	0595-2983215
甘肃省	兰州市	兰州天地电脑技术有限公司	兰州市科技街 06 号	730000	0931-8269999
甘肃省	酒泉市	酒泉创通科贸有限责任公司	甘肃省酒泉市东大街 90 号	735000	0937-2631139
广东省	湛江市	湛江市零壹电脑技术服务有限公司	湛江市赤坎区人民大道北碧海银沙电脑城 1038 之一室	524000	0759-3352182
广东省	广州市	联想电脑广州客户服务中心	广州市天河区黄埔大道中 181 号东成花苑首层 10-11 号	510660	020-85677229/85675151
广东省	深圳市	联想电脑深圳客户服务中心	深圳市南山区高新技术产业园 (南区) 联想研发中心	518057	0755-26955888-3000
广东省	江门市	江门市新时速网络技术有限公司	广东省江门市蓬江区潮江路 8 号之十六	529000	0750-3111338/3111388
广东省	惠州市	惠州市联惠电脑服务有限公司	惠州市麦地路 39 号	516001	0752-2234670
广东省	佛山市	佛山市景裕经贸有限公司计算机服务分公司	广东省佛山市华远东路 18 号 2 号铺	528000	0757-3208698
广东省	东莞市	东莞市超想电脑有限公司	广东省东莞市体育路天源电脑城 227 室	523008	0769-2470403
广东省	汕头市	汕头市海立科技有限公司	汕头市中信海滨花园西区三幢 53 号铺面	515000	0754-8941436
广西省	桂林市	桂林市利得科技有限公司	桂林市自由路花桥综合楼 1-11	541004	0773-5858990
广西省	柳州市	柳州铁路华新电子计算机技术交流站	广西柳州市南环路 19 号院 3 号楼 1 楼	545007	0772-3925176
广西省	南宁市	南宁市联鹏计算机服务有限责任公司	南宁市星湖路 37 号	530022	0771-5848812
贵州省	遵义市	遵义中立信息技术有限公司	遵义市中华路 430 号	563000	0851-5980818
贵州省	贵阳市	贵阳中阳科技服务有限公司	贵州省贵阳市中华北路 172 号	550004	0851-6833414
海南省	海口市	海南赛维计算机技术有限公司	海南省海口市五指山路 28 号联想服务	570203	0898-65313500/65313501
河北省	保定市	保定市新岛科技贸易公司	河北省保定市朝阳北路高开区路口	071051	0312-3130437/0312-3135500
河北省	张家口市	张家口市建达电脑公司	张家口市建国路 33 号	075024	0313-2043505
河北省	邯郸市	邯郸市华维科技有限公司	邯郸市中华北大街 (汉光厂段 16 号)	056002	0310-7031477
河北省	石家庄市	联想 (北京) 有限公司石家庄维修部	河北省石家庄市和平西路 79 号	050011	0311-7069631
河北省	唐山市	唐山志帮电子技术有限公司	唐山市路北区长安道永昌楼 31-5-6 号	063000	0315-2049722
河南省	信阳市	河南省信阳科宇有限公司	河南省信阳市新华西路 53 号	464000	0376-6207020
河南省	洛阳市	洛阳市东博电子技术服务有限公司	河南省洛阳市涧西区延安路 15 号	471003	0379-4911357
河南省	商丘市	河南佳泰计算机工程有限公司	商丘市民主东路高科技电子城 A 区 8 号 (台/服/外) 商丘市团结路北侧宜馨园小区 3 号楼 307 号	476000	0370-2282969
河南省	平顶山市	平顶山市长兴伟业计算机有限公司	河南省平顶山市曙光街东段 (曙光街与文明路交叉口路东 20 米)	467000	0375-4997355
河南省	新乡市	新乡超越计算机有限公司	河南省新乡市北干道 351 号 (郊委路口西)	453000	0373-3333421/3333422
河南省	郑州市	联想电脑郑州客户服务中心	郑州市农业路 66 号附 2 号	450002	0371-3910195
黑龙江省	齐齐哈尔市	齐齐哈尔市北联电脑有限责任公司	黑龙江省齐齐哈尔市龙华路 75 号	161000	0452-2408415
黑龙江省	牡丹江市	牡丹江北联电脑服务有限公司	黑龙江省牡丹江市西安区景福街 123-B 号	157000	0453-6237330
黑龙江省	佳木斯市	佳木斯三江电脑商场	佳木斯市光复路 617 号	154002	0454-8622813
黑龙江省	大庆市	大庆市萨尔图区维尔电子技术服务部	黑龙江省大庆市萨尔图区东风新村纬二路 H-9 楼 4 门	163311	0459-6390619/4603434
黑龙江省	哈尔滨市	联想电脑哈尔滨客户服务中心	哈尔滨市南岗区西大直街 19 号海燕大酒店一楼	150006	0451-3673541
湖北省	宜昌市	宜昌赛维电脑服务有限责任公司	宜昌市沿江大道 148 号	443000	0717-6254851/6254875
湖北省	十堰市	十堰市科学器材有限责任公司 118 阳光使者维修中心	十堰市朝阳中路 2 号	442000	0719-8674713/8655118
湖北省	武汉市	联想电脑武汉客户服务中心	武汉市武昌洪山区珞瑜路 188-8 号	430074	027-87876817
湖北省	襄樊市	襄樊市凯星电脑技术服务有限公司	湖北省襄樊市樊城区长虹北路诸葛亮广场铜像对面	441003	0710-3232006
湖北省	荆州市	荆州市天昊电脑科技服务有限公司	湖北荆州市南湖路 1 号	434023	0716-8477222/8430745
湖南省	衡阳市	衡阳创益电子服务有限公司	湖南省衡阳市雁峰区先锋路 117 号	421001	0734-8124888
湖南省	怀化市	怀联电脑经营部	怀化市迎丰中路 356 号	418000	0745-2710816
湖南省	长沙市	深圳联想电脑有限公司长沙客户服务部	长沙市解放中路 136-138 号	410011	0731-4436640
湖南省	岳阳市	岳阳维创软件有限公司	岳阳市巴陵中路人保大厦西侧创业中心一楼	414000	0730-8284363

湖南省	株洲市	株洲今联数码科技有限公司	株洲市华联电脑城C座108号	412000	0733-8287058
吉林省	长春市	长春东大电脑技术有限公司	长春市人民大街8号长春科技城2B17室	130051	0431-2785885/2788678
吉林省	延吉市	延边天池电脑公司	吉林省延吉市河南街61-4号	133001	0433-2836402
吉林省	吉林市	吉林三豪电子工程有限公司	吉林省吉林市重庆街121号	132001	0432-2548888/2538888
江苏省	苏州市	苏州市创捷工业控制技术有限公司维修站	苏州市十全街933号	215006	0512-65100387
江苏省	徐州市	徐州市徐联计算机有限公司	徐州市中山南路131号	221003	0516-3817919
江苏省	连云港市	连云港市东凌计算机技术服务有限公司维修中心	连云港市新浦区通灌南路88号	222003	0518-5400111
江苏省	无锡市	无锡市中科新瑞系统集成有限公司	无锡市解放东路890-2号	214007	0510-2828280
江苏省	扬州市	扬州安泰新技术开发有限公司	扬州市大学北路120号(京华大酒店向南50米)	225009	0514-7360780
江苏省	常州市	常州市凯特计算机技术有限公司	常州市西横街23号	213003	0519-6670386
江苏省	南京市	联想(上海)有限公司南京客户服务部	南京市王府大街115号	210004	025-4466994-118
江苏省	南通市	南通晓东电脑有限公司	南通市北郭东村23号附房01号	226006	0513-5280433
江西省	南昌市	江西诚维技术服务有限公司	南昌市南京西路271号(南昌市中级人民法院对面)	330006	0791-6250578/6250598
辽宁省	丹东市	丹东市九三电脑有限公司	丹东市振兴区八纬路钟源小区3号楼106室	118000	0415-2145654/2129093
辽宁省	锦州市	锦州市太和电脑有限公司	锦州市中央大街二段44-88号	121000	0416-3147341/3135707
辽宁省	本溪市	本溪市仁合电脑科技中心	本溪市平山区铁路街189号	117000	0414-2837113
辽宁省	抚顺市	抚顺市兴联科技服务站	抚顺市新抚区东二街7号	113008	0413-2600998
辽宁省	鞍山市	鞍山市中冶电脑网络有限公司	鞍山市铁东区南中华路259号	114000	0412-6342588/6332525
辽宁省	沈阳市	联想电脑沈阳客户服务中心	沈阳市沈河区望云寺路50号	110013	024-22950561
辽宁省	大连市	大连市联创科技发展有限公司	大连市西岗区新华街57号(体育场11号看台)	116021	0411-3771281
内蒙古	包头市	包头市杰诚电子技术服务有限公司	包头市青山区富强路10#29号	014030	0472-3341597
内蒙古	海拉尔	呼伦贝尔盟科教电脑应用服务中心	内蒙古海拉尔市西四道街西四综合楼6号联想服务	021000	0470-8347755
内蒙古	呼和浩特市	呼和浩特市联心计算机技术服务有限公司	内蒙古呼和浩特市呼伦南路7号	010020	0471-6917978/0471-6917948
宁夏	银川市	银川普信阳光信息技术服务有限公司	银川市民族北街25号	750001	0951-6023966
青海省	西宁市	西宁华冠技术服务有限公司	西宁市西关大街59号	810001	0971-6166428
山东省	聊城市	山东省聊城市科霸电脑有限公司	山东省聊城市花园北路55号	252000	0635-8431177
山东省	济南市	联想电脑济南客户服务中心	济南市历下区解放路84-1号	250013	0531-6412819/6998538
山东省	淄博市	淄博盈科计算机技术服务有限公司	山东省淄博市张店区太平路9号	255000	0533-2880550
山东省	青岛市	联想电脑青岛客户服务中心	青岛市威海路262号	266021	0532-3023082
山东省	潍坊市	山东潍坊洽达电子公司	山东省潍坊市潍城区向阳路132号	261021	0536-8380849/0536-8339306
山东省	烟台市	烟台中天科技有限公司	烟台市芝罘区兴业路28号	264000	0535-6665680
山东省	东营市	东营区万维计算机服务中心	东营市东营区黄河路10-14号	257000	0546-8558777/0546-8780909
山东省	济宁市	济宁先锋信息服务有限责任公司	济宁市建设北路116号	272125	0537-2384111/2310048/2384222
山西省	大同市	大同市城区银河电脑服务部	大同市南关大街15号	037008	0352-5022854
山西省	运城市	运城志诚电子有限公司	山西省运城市中银大道1396号	044000	0359-2090562
山西省	长治市	长治市海航科技有限公司	山西省长治市太行东路3号	046011	0355-2032127
山西省	太原市	联想(北京)有限公司太原客户服务中心	太原市桥东街桥东小区G区15号楼底商3\4号	030001	0351-4637035
陕西省	宝鸡市	宝鸡市微电子有限责任公司	宝鸡市体育路步行街16号-7号商业房	721000	0917-3203322
陕西省	汉中市	汉中中联翔电子有限公司	陕西省汉中市兴汉路中段(桃心岛家电公司对面)	723000	0916-2112562
陕西省	咸阳市	咸阳新阳光信息技术有限公司	陕西省咸阳市咸通南路联想服务	712000	0910-3322555
陕西省	西安市	联想电脑西安客户服务中心	陕西省西安市太乙路南段1号	710054	029-8261188-2159
上海市	上海市	联想(上海)有限公司技术服务部	上海市长宁区法华镇路358号	200052	021-62838209
上海市	上海市	联想上海虹口区客户服务中心	上海市曲阳路17号	200081	021-55560256
四川省	南充市	南充中立技术服务有限责任公司	南充市顺庆区文化路264号	637000	0817-2234777
四川省	宜宾市	宜宾中立现代办公设备维修有限责任公司	四川省宜宾市大南街82号附6号	644000	0831-8213704
四川省	绵阳市	江油市中立联盟电脑技术服务有限公司	绵阳市长虹大道中段121号电子商城801室	621000	0816-2311700
四川省	成都市	联想电脑成都客户服务中心	成都市新南路四维村1#亚华大厦二楼	610041	028-85447487
天津市	天津市	天津市南开区南开电子技术开发研究所	天津市南开区三潭路196号	300192	022-27454769/27454770
新疆	乌鲁木齐市	乌鲁木齐市宝隆技术服务有限公司	乌鲁木齐市新华南路56号附5号	830002	0991-2855588/2856688
云南省	个旧市	红河州中立计算机技术服务部	云南省红河州个旧市中山路34号精诚电脑	661000	0873-2134855-207
云南省	昆明市	联想电脑昆明客户服务中心	昆明市一二一大街文昌巷云师大综合楼	650031	0871-5394783
浙江省	温州市	温州市晨星科技有限公司	温州市环城东路瑞信大楼112-1号	325000	0577-88831664
浙江省	台州市	台州市椒江远见电脑销售中心	浙江省台州市椒江区中山西路306号	318000	0576-8224477/8224466
浙江省	金华市	金华壹加壹计算机技术服务有限公司	浙江省金华市李渔路976号	321017	0579-2374848
浙江省	宁波市	宁波腾达电脑技术服务有限公司	宁波市孝闻街118号	315010	0574-87273368
浙江省	杭州市	联想(上海)有限公司杭州技术服务部	杭州市湖墅南路241号	310005	0571-88392861
重庆市	重庆市	重庆中立联盟科技有限公司	重庆市两路口皇冠大厦12F-C	400014	023-63872659
重庆市	重庆市	联想电脑重庆客户服务中心	重庆市渝中区长江一路69号	400014	023-69081138

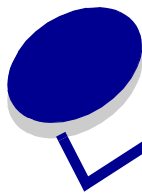

Notices

Electronic emission notices

Federal Communications Commission (FCC) compliance information statement

The Lenovo 5110 DigitalPrinter, type 4136-LG1, and Lenovo 6110 DigitalPrinter, type 4136-LP1, has been tested and found to comply with the limits for a Class B digital device, pursuant to Part 15 of the FCC Rules. Operation is subject to the following two conditions: (1) this device may not cause harmful interference, and (2) this device must accept any interference received, including interference that may cause undesired operation.

The FCC Class B limits are designed to provide reasonable protection against harmful interference in a residential installation. This equipment generates, uses, and can radiate radio frequency energy and, if not installed and used in accordance with the instructions, may cause harmful interference to radio communications. However, there is no guarantee that interference will not occur in a particular installation. If this equipment does cause harmful interference to radio or television reception, which can be determined by turning the equipment off and on, the user is encouraged to try to correct the interference by one or more of the following measures:

- Reorient or relocate the receiving antenna.
- Increase the separation between the equipment and receiver.
- Connect the equipment into an outlet on a circuit different from that to which the receiver is connected.
- Consult your point of purchase or service representative for additional suggestions.

The manufacturer is not responsible for any radio or television interference caused by using other than recommended cables or by unauthorized changes or modifications to this equipment. Unauthorized changes or modifications could void the user's authority to operate this equipment.

Note: To assure compliance with FCC regulations on electromagnetic interference for a Class B computing device, use a properly shielded and grounded cable for parallel attach or for USB attach. Use of a substitute cable not properly shielded and grounded may result in a violation of FCC regulations.

Any questions regarding this compliance information statement should be directed to:

Director of Lexmark Technology & Services
Lexmark International, Inc.
740 West New Circle Road
Lexington, KY 40550
(859) 232-3000

European Community (EC) directives conformity

This product is in conformity with the protection requirements of EC Council directives 89/336/EEC and 73/23/EEC on the approximation and harmonization of the laws of the Member States relating to electromagnetic compatibility and safety of electrical equipment designed for use within certain voltage limits.

A declaration of conformity with the requirements of the directives is available by contacting Lenovo. Lenovo (Beijing) Ltd. No. 6 Chuang Ye Road, Shangdi Information Industry Base, Haidian District, Beijing, China. Post Code : 100085. Tel: 86-10-82878888.

This product satisfies the Class B limits of EN 55022 and safety requirements of EN 60950.

Environmental Temperature:

Operating: 16 °C – 32 °C
Storage: 1 °C – 60 °C
Transportation: -40 °C – 60 °C

Note: To ensure good printing quality, please put the product under operating environment for a period of time before using if it has been kept in a cold environment.

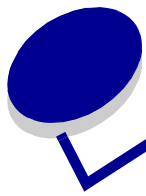

Glossary

alignment page. A page with printed alignment patterns that ejects from your printer during cartridge alignment.

alignment values. Numbers corresponding to patterns on the alignment page.

automatic alignment. A feature that automatically aligns the print cartridges.

Automatic Sheet Feeder (ASF). A mechanism that automatically feeds paper into your printer.

banner paper. Continuous sheets of perforated inkjet paper designed for banners. Also called continuous form paper.

booklets. Multiple pages printed, folded, and bundled to resemble a small book.

bundle. A group of booklet pages that are folded in half and stacked before binding.

cartridge contact. The gold area on your print cartridge that touches the carrier contacts inside your printer.

coated paper. Treated paper designed for high-quality printed images.

collate. A printer software option that lets you automatically print one complete copy of a multiple-page document before the next copy begins, and so on.

continuous form paper. See banner paper.

custom size paper. A nonstandard paper size.

default printer. The printer automatically used when you send jobs to print.

default printer settings. Printer software settings defined when the printer is manufactured.

driver. See printer software.

duplex. A printer software option that lets you print on both sides of a sheet of paper.

glossy paper. Paper with one glossy side designed for photographs.

handouts. Multiple-page images printed on a single sheet of paper. See **N-up**.

label. Self-adhesive paper.

landscape orientation. Page orientation in which text runs parallel with the long edge of the paper.

line art. A printer software option used for printing simple line art and graphics.

long-edge binding. A printer software option that arranges duplexed pages so they can be bound along the long side of the pages.

manual alignment. A printer software feature that lets you select print cartridge alignment values.

margins. The blank area between printed text or graphics and the edges of a page.

mirror. A printer software option that lets you reverse an image before printing.

N-up. A printer software option that lets you print multiple pages of a document on a single sheet of paper. For example, select 4-up to print reduced images of pages 1 through 4 on the first sheet of paper, images of pages 5 through 8 on the second sheet, and so on.

natural color. A printer software option used for printing photographs and highly detailed graphic images.

operating system. The software that provides the basic functions needed for operating your computer. For example, Windows 98.

paper type sensor. A feature that automatically detects some types of paper loaded in the paper tray.

peripheral device. Any external device connected to and controlled by a computer.

photo paper. Treated paper designed for photographs.

plain paper. Paper designed for printing text documents.

portrait orientation. Page orientation in which text runs parallel with the short edge of the paper.

poster. An image printed on multiple sheets of paper that, when assembled, produce an enlarged version of the original image.

premium paper. Coated paper designed for reports or documents with graphics.

print cartridge. The replaceable unit inside your printer that contains the ink.

print cartridge nozzles. The gold area of the print cartridge that ink flows through before it is applied to your paper during printing.

print queue. The location on the server where print jobs are stored for printing in the order in which they are sent.

printer driver. See printer software.

printer port. See USB port.

printer software. (1) The program that lets you select settings to customize your print job. (2) The program that lets your computer communicate with your printer.

program. Any software loaded on your computer that lets you perform a specific task, such as word processing or photo editing.

reverse order printing. A printer software option that lets you print the last page of your document first so your pages are in sequential order on the exit tray.

sharpen. A printer software option that reduces the blurriness of a printed image.

short-edge binding. A printer software option that arranges duplexed pages so they can be bound along the short side of the pages.

side flip. A printer software option that arranges duplexed pages so they turn like the pages of a magazine.

software program. See program.

top flip. A printer software option that arranges duplexed pages so they turn like the pages of a legal pad.

transparency. A see-through sheet of print media that can be displayed on an overhead projector.

USB cable. A lightweight, flexible cable that lets your printer communicate with your computer. USB cables transmit data at much higher speeds than parallel cables.

USB port. A small, rectangular port on the back of your computer that connects to peripheral devices, such as a printer, using a USB cable. The USB port lets your computer communicate with your printer at high speeds.

watermark. A light graphic or background text that appears on each page of a document.

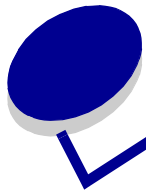

Index

A

aligning print cartridges 47

B

banding 61
banner paper 39
booklet
 building 26
borderless printing 14, 15, 21

C

cable, part numbers
 USB 50
cards 19
cartridges, print
 aligning 47
 installing 45
 ordering 50
 part numbers 43
 preserving 49
 removing 43
 replacing 43
 troubleshooting 51
characters, malformed 62
coated paper 14
color cartridge part number 43
conserving color ink 23
custom size paper 41
customizing settings
 banner paper 39
 booklet 24
 borderless photos 14, 15
 both sides of the paper 17
 cards 19
 coated paper 14
 custom size paper 41
 driver 9
 duplexing 17

envelopes 21
glossy paper 14
greeting cards 19
handouts
 See multiple images on
 one sheet
index cards 19
iron-on transfers 34
labels 27
last page first 37
multiple images on one
 sheet 29
photo cards 19
photo paper 14
plain paper 13
postcards 19
poster 31
premium paper 16
printing color images in black
 and white 23
printing in reverse order 37
printing multiple images on
 one sheet 29
transparencies 35
t-shirt transfers 34
two-sided printing 17

D

dark or smudged print 60
default settings 9
digital media 7
downloaded printer driver,
 installing 54
duplexing 17

E

electronic emission notices 66
emission statement 66

envelopes 21
error messages
 Ink Low 55
 Paper Jam 55

F

FCC statement 66
flashing lights 55

G

glossy paper 14
greeting cards 19

H

handouts 29

I

improving print quality 60
index cards 19
Ink Low message 55
installing
 print cartridges 45
 printer software 54
intermittent printing 61
iron-on transfers 34

L

labels 27
Lenovo Solution Center 11
loading
 banner paper 39
 booklet 24
 cards 19
 coated paper 14
 custom size paper 41
 duplexing 17
 envelopes 21

- glossy paper 14
- greeting cards 19
- handouts 29
- index cards 19
- iron-on transfers 34
- labels 27
- photo cards 19
- photo paper 14
- postcards 19
- poster 31
- premium paper 16
- print on both sides of the paper 17
- transparencies 35
- t-shirt transfers 34
- two-sided printing 17

M

- manual cartridge alignment 47
- margins, minimum settings 61
- memory cards 7
- messages, error
 - Ink Low 55
 - Paper Jam 55
- multiple images on one sheet 29

N

- N-up 29

O

- ordering supplies 50

P

- Paper Jam message 55
- paper jam, clearing 60
- paper misfeeds 59
- Paper Setup tab 10
- part numbers
 - color cartridge 43
 - USB cable 50
- photo cards 19
- photo paper 14
- postcards 19
- poster 31
- premium paper 16
- print cartridge

- aligning 47
- installing 45
- ordering 50
- part numbers 43
- preserving 49
- replacing 43
- print color images in black and white 23
- print in reverse order 37
- print last page first 37
- Print Layout tab 10
- print on both sides of the paper 17
- print quality
 - improving 47
- printer cable,
 - troubleshooting 51
- printer driver
 - installing 54
 - removing 54
- printer parts 6
- printer software
 - driver 8
 - installing 54
 - Lenovo Solution Center 8
 - removing 54
- printer software CD,
 - troubleshooting 52
- printing
 - alignment page 47
 - banner paper 39
 - booklet 24
 - borderless photo 14, 15
 - cards 19
 - coated paper 14
 - color images in black and white 23
 - custom size paper 41
 - duplexing 17
 - envelopes 21
 - glossy paper 14
 - greeting cards 19
 - handouts
 - See multiple images on one sheet
 - index cards 19
 - iron-on transfers 34
 - labels 27

- last page first 37
- N-up
 - See multiple images on one sheet
- photo cards 19
- photo paper 14
- plain paper 13
- postcards 19
- poster 31
- premium paper 16
- print on both sides of the paper 17
- reverse order 37
- test page 52
- transparencies 35
- t-shirt transfers 34
- two-sided printing 17

- printing problems
 - blank pages 58
 - error messages 55
 - flashing lights 55
 - paper feeding 59
 - paper jams 60
 - print quality 60
 - software 52
 - specialty paper 63
 - unsuccessful or slow printing 57

Q

- Quality/Copies tab 10

R

- removing print cartridges 43
- removing printer software 54
- replacing print cartridges 43

S

- setting recommendations
 - banner paper 39
 - booklet 24
 - borderless photos 14, 15
 - both sides of the paper 17
 - cards 19
 - coated paper 14
 - color images in black and white 23

- custom size paper 41
- default 9
- duplexing 17
- envelopes 21
- glossy paper 14
- greeting cards 19
- handouts 29
- index cards 19
- iron-on transfers 34
- labels 27
- last page first 37
- photo cards 19
- photo paper 14
- plain paper 13
- postcards 19
- poster 31
- premium paper 16
- print color images in black and white 23
- print last page first 37
- print on both sides of the paper 17
- transparencies 35
- t-shirt transfers 34
- two-sided printing 17
- settings, default 9
- slow printing 59
- software, printer 8
 - installing 54
 - removing 54
- specialty paper
 - solving problems with 63
- supplies, ordering 50

T

- test page
 - alignment 47
 - does not print 58
- test page, printing 52
- transfers, iron-on 34
- transparencies 35
- troubleshooting
 - alignment page 58
 - blank pages 58
 - cartridges 51
 - error messages 55
 - flashing lights 55
 - improving print quality 60

- margins 61
- paper feeding 59
- paper jams 60
- paper misfeeds 59
- print quality 60
- printer cable 51
- printer not printing 57
- printer software
 - installation 52
- slow printing 59
- software 52
- solving print quality problems 60
- specialty paper 63
- test page 52
- uninstalling software (Windows) 58
- unsuccessful or slow printing 57
- t-shirt transfers 34
- two-sided printing 17

U

- USB cable
 - ordering 50

***lenovo* 联想**

联想 and Lenovo are trademarks of Lenovo (Beijing), Ltd.,

Free Manuals Download Website

<http://myh66.com>

<http://usermanuals.us>

<http://www.somanuals.com>

<http://www.4manuals.cc>

<http://www.manual-lib.com>

<http://www.404manual.com>

<http://www.luxmanual.com>

<http://aubethermostatmanual.com>

Golf course search by state

<http://golfingnear.com>

Email search by domain

<http://emailbydomain.com>

Auto manuals search

<http://auto.somanuals.com>

TV manuals search

<http://tv.somanuals.com>