



OWNER'S MANUAL

Network Blu-ray Disc™ / DVD Player

Please read this manual carefully before operating
your set and retain it for future reference.

*Note : NetCast™ feature is available with BD678N series only.

MODEL
BD550 / BD678N*

P/NO : MFL66983401(02)

1

Safety Information



CAUTION: TO REDUCE THE RISK OF ELECTRIC SHOCK DO NOT REMOVE COVER (OR BACK) NO USER-SERVICEABLE PARTS INSIDE REFER SERVICING TO QUALIFIED SERVICE PERSONNEL.



This lightning flash with arrowhead symbol within an equilateral triangle is intended to alert the user to the presence of uninsulated dangerous voltage within the product's enclosure that may be of sufficient magnitude to constitute a risk of electric shock to persons.



The exclamation point within an equilateral triangle is intended to alert the user to the presence of important operating and maintenance (servicing) instructions in the literature accompanying the product.

Cautions and Warnings

WARNING: TO PREVENT FIRE OR ELECTRIC SHOCK HAZARD, DO NOT EXPOSE THIS PRODUCT TO RAIN OR MOISTURE.

WARNING: Do not install this equipment in a confined space such as a book case or similar unit.

CAUTION: Do not block any ventilation openings. Install in accordance with the manufacturer's instructions.

Slots and openings in the cabinet are provided for ventilation and to ensure reliable operation of the product and to protect it from over heating. The openings shall be never be blocked by placing the product on a bed, sofa, rug or other similar surface. This product shall not be placed in a built-in installation such as a bookcase or rack unless proper ventilation is provided or the manufacturer's instruction has been adhered to.

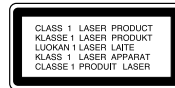

CAUTION: This product employs a Laser System. To ensure proper use of this product, please read this owner's manual carefully and retain it for future reference. Shall the unit require maintenance, contact an authorized service center. Use of controls, adjustments or the performance of procedures other than those specified herein may result in hazardous radiation exposure. To prevent direct exposure to laser beam, do not try to open the enclosure. Visible laser radiation when open. DO NOT STARE INTO BEAM.

CAUTION concerning the Power Cord

Most appliances recommend they be placed upon a dedicated circuit;

That is, a single outlet circuit which powers only that appliance and has no additional outlets or branch circuits. Check the specification page of this owner's manual to be certain. Do not overload wall outlets. Overloaded wall outlets, loose or damaged wall outlets, extension cords, frayed power cords, or damaged or cracked wire insulation are dangerous. Any of these conditions could result in electric shock or fire. Periodically examine the cord of your appliance, and if its appearance indicates damage or deterioration, unplug it, discontinue use of the appliance, and have the cord replaced with an exact replacement part by an authorized service centre. Protect the power cord from physical or mechanical abuse, such as being twisted, kinked, pinched, closed in a door, or walked upon. Pay particular attention to plugs, wall outlets, and the point where the cord exits the appliance. To disconnect power from the mains, pull out the mains cord plug. When installing the product, ensure that the plug is easily accessible.

This device is equipped with a portable battery or accumulator.

Safety way to remove the battery or the battery from the equipment:

Remove the old battery or battery pack, follow the steps in reverse order than the assembly. To prevent contamination of the environment and bring on possible threat to human and animal health, the old battery or the battery put it in the appropriate container at designated collection points. Do not dispose of batteries or battery together with other waste. It is recommended that you use local, free reimbursement systems batteries and accumulators. The battery shall not be exposed to excessive heat such as sunshine, fire or the like.

CAUTION: The apparatus shall not be exposed to water (dripping or splashing) and no objects filled with liquids, such as vases, shall be placed on the apparatus.

Disposal of your old appliance



1. When this crossed-out wheeled bin symbol is attached to a product it means the product is covered by the European Directive 2002/96/EC.
2. All electrical and electronic products shall be disposed of separately from the municipal waste stream via designated collection facilities appointed by the government or the local authorities.
3. The correct disposal of your old appliance will help prevent potential negative consequences for the environment and human health.
4. For more detailed information about disposal of your old appliance, please contact your city office, waste disposal service or the shop where you purchased the product.

CE LG Electronics hereby declares that this/ these product(s) is/are in compliance with the essential requirements and other relevant provisions of Directive 2004/108/EC, 2006/95/EC and 2009/125/EC.

European representative : LG Electronics Service Europe B.V.Veluwezoom 15, 1327 AE Almere, The Netherlands (Tel : +31-(0)36-547-8888)

Notes on Copyrights

- Because AACS (Advanced Access Content System) is approved as content protection system for BD format, similar to use of CSS (Content Scramble System) for DVD format, certain restrictions are imposed on playback, analog signal output, etc., of AACS protected contents. The operation of this product and restrictions on this product may vary depending on your time of purchase as those restrictions may be adopted and/or changed by AACS after the production of this product.
- Furthermore, BD-ROM Mark and BD+ are additionally used as content protection systems for BD format, which imposes certain restrictions including playback restrictions for BD-ROM Mark and/or BD+ protected contents. To obtain additional information on AACS, BD-ROM Mark, BD+, or this product, please contact an authorized Customer Service Centre.
- Many BD-ROM/DVD discs are encoded with copy protection. Because of this, you should only connect your player directly to your TV, not to a VCR. Connecting to a VCR results in a distorted picture from copy-protected discs.
- **This product incorporates copyright protection technology that is protected by U.S. patents and other intellectual property rights. Use of this copyright protection technology must be authorized by Rovi Corporation, and is intended for home and other limited viewing uses only unless otherwise authorized by Rovi Corporation. Reverse engineering or disassembly is prohibited.**
- Under the U.S. Copyright laws and Copyright laws of other countries, unauthorized recording, use, display, distribution, or revision of television programs, videotapes, BD-ROM discs, DVDs, CDs and other materials may subject you to civil and/or criminal liability.

Important Notice for TV colour system

The colour system of this player differs according to currently playing discs.

For example, when the player plays the disc recorded in the NTSC colour system, the image is output as an NTSC signal.

Only the multi system colour TV can receive all signals output from the player.

- If you have a PAL colour system TV, you will see just distorted images when using discs or video contents recorded in NTSC.
- The multi system colour TV changes the colour system automatically according to input signals. In case that the colour system is not changed automatically, turn it off and then on to see normal images on screen.

Even if the disc recorded in NTSC colour system are well displayed on your TV, these may not be recorded correctly on your recorder.

Contents

1

Safety Information

- 3 Cautions and Warnings

2

Preparation

- 8 **Introduction**
- 8 About the "⊘" Symbol Display
- 8 Symbols Used in this Manual
- 8 Supplied Accessories
- 9 Playable Discs
- 10 File compatibility
- 11 Regional Code
- 11 AVCHD (Advanced Video Codec High Definition)
- 11 Certain System Requirements
- 11 Compatibility Notes
- 12 **Remote control**
- 13 **Front panel**
- 13 **Rear panel**

3

Installation

- 14 **Connecting to Your TV**
- 14 HDMI Connection
- 15 What is SIMPLINK?
- 16 Component Video Connection
- 16 Video/Audio (Left/Right) Connection
- 17 Resolution Setting
- 18 **Connecting to an Amplifier**
- 18 Connecting to an Amplifier via HDMI Output
- 19 Connecting to an Amplifier via Digital Audio Output
- 19 Connecting to an Amplifier via 2 Channel Audio Output
- 20 **Connecting to your Home Network**
- 20 Network connection
- 21 Wired Network Setup
- 23 **USB device connection**
- 23 Playback content in the USB device
- 24 **Settings**
- 24 Adjust the Setup Settings
- 25 [DISPLAY] Menu
- 26 [LANGUAGE] Menu
- 27 [AUDIO] Menu
- 29 [LOCK] Menu
- 30 [NETWORK] Menu
- 30 [OTHERS] Menu

4 Operation

- 32 General Playback
- 34 Advanced Playback
- 37 On-Screen display
- 39 Enjoying BD-LIVE
- 40 Playing a movie file and VR disc
- 42 Viewing a photo
 - 42 Options while viewing a photo
- 43 Listening to music while slide show
- 44 Listening to music
 - 44 Displaying MP3 music information (ID3 Tag)
 - 44 Audio CD Recording
 - 46 Using the NetCast™ Entertainment Access
 - 48 Playing YouTube™ videos
 - 51 Viewing Picasa™ Web Album

5 Maintenance

- 54 Notes on Discs
- 54 Handling the Unit

6 Troubleshooting

- 55 General
- 56 Picture
- 56 Sound
- 57 Network

7 Appendix

- 58 Controlling a TV with the Supplied Remote Control
- 59 Network Software Update
- 61 Area Code List
- 62 Language code List
- 63 Trademarks and Licenses
- 64 Audio Output Specifications
- 66 Video Output Resolution Specifications
- 67 Specifications
- 68 Important Information Relating to Network Services
- 69 Open source software notice

1

2

3

4

5

6

7

8

2 Preparation

Introduction

About the “⊘” Symbol Display

“⊘” may appear on your TV display during operation and indicates that the function explained in this owner’s manual is not available on that specific media.

Symbols Used in this Manual



NOTE

Indicates special notes and operating features.



CAUTION

Indicates cautions for preventing possible damages from abuse.

A section whose title has one of the following symbols are applicable only to the disc represented by the symbol.

BD	BD-ROM disc
DVD	DVD-Video, DVD±R/RW in Video mode or VR mode and finalized
AVCHD	DVD±R/RW in AVCHD format
ACD	Audio CDs
MOVIE	Movie files contained in the USB/Disc

MUSIC

Music files contained in the USB/Disc

PHOTO

Photo files

Supplied Accessories

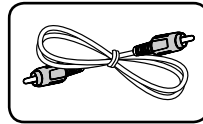

Video cable (1)

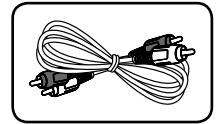

Audio cable (1)

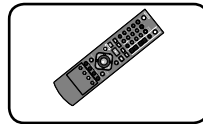

Remote control (1)

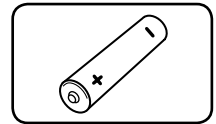

Battery (1)

Playable Discs



Blu-ray Disc

- Discs such as movies that can be purchased or rented.
- BD-R/RE discs that contain Movie, Music or Photo files.



DVD-VIDEO (8 cm / 12 cm disc)

Discs such as movies that can be purchased or rented.



DVD±R (8 cm / 12 cm disc)

- Video mode and finalized only
- Supports the dual layer disc also
- Finalized AVCHD format
- DVD±R discs that contain Movie, Music or Photo files.



DVD-RW (8 cm / 12 cm disc)

- VR mode, Video mode and finalized only
- Finalized AVCHD format
- DVD-RW discs that contain Movie, Music or Photo files.



DVD+RW (8 cm / 12 cm disc)

- Video mode and finalized only
- Finalized AVCHD format
- DVD+RW discs that contain Movie, Music or Photo files.



Audio CD (8 cm / 12 cm disc)



CD-R/RW (8 cm / 12 cm disc)

- CD-R/RW discs that contain audio titles, Movie, Music or Photo files.

! NOTE

- Depending on the conditions of the recording equipment or the CD-R/RW (or DVD±R/RW) disc itself, some CD-R/RW (or DVD±R/RW) discs cannot be played on the unit.
- Depending on the recording software & the finalization, some recorded discs (CD-R/RW, DVD ±R/RW, BD-R/RE) may not be playable.
- BD-R/RE, DVD±R/RW and CD-R/RW discs recorded using a personal computer or a DVD or CD Recorder may not play if the disc is damaged or dirty, or if there is dirt or condensation on the player's lens.
- If you record a disc using a personal computer, even if it is recorded in a compatible format, there are cases in which it may not play because of the settings of the application software used to create the disc. (Check with the software publisher for more detailed information.)
- This player requires discs and recordings to meet certain technical standards in order to achieve optimal playback quality.
- Pre-recorded DVDs are automatically set to these standards. There are many different types of recordable disc formats (including CD-R containing MP3 or WMA files) and these require certain pre-existing conditions to ensure compatible playback.
- Customers should note that permission is required in order to download MP3 / WMA files and music from the Internet. Our company has no right to grant such permission. Permission should always be sought from the copyright owner.
- You have to set the disc format option to [Mastered] in order to make the discs compatible with the LG players when formatting rewritable discs. When setting the option to Live System, you cannot use it on LG player. (Mastered/Live File System : Disc format system for windows Vista)

File compatibility

Overall

Available File extensions: ".jpg", ".jpeg", ".png", ".avi", ".divx", ".mpg", ".mpeg", ".mkv", ".mp4", ".mp3", ".wma", ".wav", ".gif"

- Some wav files are not supported on this player.
- The file name is limited to 180 characters.
- Depending on the size and number of the files, it may take several minutes to read the contents on the media.

Maximum Files/Folder: Less than 2000 (total number of files and folders)

CD-R/RW, DVD±R/RW, BD-R/RE Format:

ISO 9660+JOLIET, UDF and UDF Bridge format

MOVIE

Available resolution size: 1920 x 1080 (W x H) pixels

Playable subtitle: SubRip (.srt / .txt), SAMI (.smi), SubStation Alpha (.ssa/.txt), MicroDVD (.sub/.txt), VobSub (.sub), SubViewer 1.0 (.sub), SubViewer 2.0 (.sub/.txt), TMPlayer (.txt), DVD Subtitle System (.txt)

Playable Codec format: "DIVX3.xx","DIVX4.xx", "DIVX5.xx","XVID","DIVX6.xx"(Standard playback only), H.264/MPEG-4 AVC, MPEG1 SS, MPEG2 PS, MPEG2 TS

Playable Audio format: "Dolby Digital","DTS", "MP3","WMA","AAC","AC3"

- Not all the WMA and AAC Audio format are compatible with this unit.

Sampling frequency: within 32-48 kHz (WMA), within 16-48 kHz (MP3)

Bit rate: within 20-320Kbps (WMA), within 32-320Kbps (MP3)



NOTE

- HD movie files contained on the CD or USB 1.0/1.1 may not played properly. BD, DVD or USB 2.0 are recommended to play back HD movie files.
- This player support H.264/MPEG-4 AVC profile Main, High at Level 4.1. For a file with higher level, the warning message will appear on the screen.
- This player does not support the file that are recorded with GMC*¹ or Qpel*². Those are video encoding techniques in MPEG4 standard, like DivX or XVID have.

*¹ GMC – Global Motion Compensation

*² Qpel – Quarter pixel

Audio Files

Sampling frequency: within 8 - 48kHz (WMA), within 11 - 48kHz (MP3)

Bit rate: within 8 - 320 kbps (WMA, MP3),



NOTE

- This unit cannot support the ID3 Tag embedded MP3 file.
- The total playback time indicated on the screen may not correct for VBR files.

Photo Files

Recommended size:

Less than 4,000 x 3,000 x 24 bit/pixel

Less than 3,000 x 3,000 x 32 bit/pixel

- Progressive and lossless compression photo image files are not supported.

Regional Code

This unit has a regional code printed on the rear of the unit. This unit can play only BD-ROM or DVD discs labeled same as the rear of the unit or "ALL".

AVCHD (Advanced Video Codec High Definition)

- This player can playback AVCHD format discs. These discs are normally recorded and used in camcorders.
- The AVCHD format is a high definition digital video camera format.
- The MPEG-4 AVC/H.264 format is capable of compressing images at higher efficiency than that of the conventional image compressing format.
- Some AVCHD discs use the "x.v.Color" format.
- This player can playback AVCHD discs using "x.v.Color" format.
- Some AVCHD format discs may not play depending on the recording condition.
- AVCHD format discs need to be finalized.
- "x.v.Color" offers a wider color range than normal DVD camcorder discs.

Certain System Requirements

For high definition video playback:

- High definition display that has COMPONENT or HDMI input jacks.
- BD-ROM disc with high definition content.
- HDMI or HDCP capable DVI input on your display device is required for some content (as specified by disc authors).
- For up-conversion of standard definition DVD, a HDMI or HDCP capable DVI input on your display device is required for copy protected content.

For Dolby® Digital Plus, Dolby TrueHD and DTS-HD multi-channel audio playback:

- An amplifier/receiver with a built-in (Dolby Digital, Dolby Digital Plus, Dolby TrueHD, DTS or DTS-HD) decoder.
- Main, center, surround speakers and subwoofer as necessary for chosen format.

Compatibility Notes

- Because BD-ROM is a new format, certain disc, digital connection and other compatibility issues are possible. If you experience compatibility problems, please contact an authorized Customer Service Center.
- Viewing high-definition content and up-converting standard DVD content may require a HDMI-capable input or HDCP-capable DVI input on your display device.
- Some BD-ROM and DVD discs may restrict the use of some operation commands or features.
- Dolby TrueHD, Dolby Digital Plus and DTS-HD are supported with maximum 7.1 channels if you use HDMI connection for the audio output of the unit.
- You can use a USB device that is used to store some disc related information, including downloaded on-line content. The disc you are using will control how long this information is retained.

Remote control

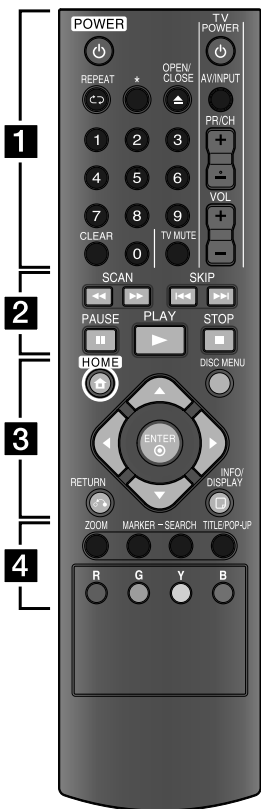

..... **1**

⏻ (POWER): Switches the player ON or OFF.

REPEAT: Repeats a desired section or sequence.

*****: The button is not available for any function.

⏪ (OPEN/CLOSE): Opens and closes the disc tray.

0-9 numerical buttons: Selects numbered options in a menu or inputs letters in the keypad menu.

CLEAR: Removes a mark on the search menu or a number when setting the password.

TV Control Buttons: See page 50.

..... **2**

⏮/⏭ (SCAN): Searches backward or forward.

⏮/⏭ (SKIP): Goes to the next or previous chapter / track / file.

⏸ (PAUSE): Pauses playback.

▶ (PLAY): Starts playback.

■ (STOP): Stops playback.

..... **3**

HOME (🏠): Displays or exits the [Home Menu].

DISC MENU: Accesses menu on a disc.

Direction buttons: Selects an option in the menu.

ENTER (⊙): Acknowledges menu selection.

RETURN (↶): Exits the menu or resumes playback. The resume play function may not work depending on the BD-ROM disc.

INFO/DISPLAY (⏏): Displays or exits On-Screen Display.

..... **4**

ZOOM: Displays or exits the [Zoom] menu.

MARKER: Marks any point during playback.

SEARCH: Displays or exits the search menu.

TITLE/POP-UP: Displays the DVD title menu or BD-ROM's pop-up menu, if available.

Colored (R, G, Y, B) buttons: Use to navigate BD-ROM menus. They are also used for [MOVIE], [PHOTO] and [MUSIC] menu.

Battery Installation

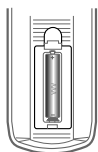

Remove the battery cover on the rear of the Remote Control, and insert one R03 (size AAA) battery with **+** and **-** matched correctly.

Front panel

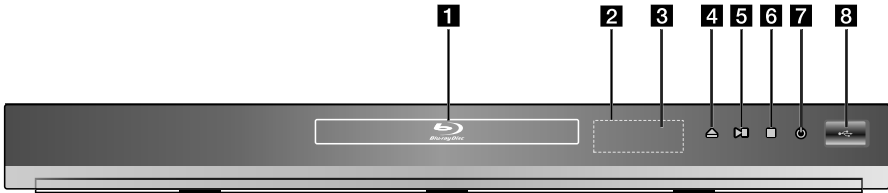

- | | |
|-------------------------|------------------------------|
| 1 Disc Tray | 5 ▶/ (PLAY / PAUSE) |
| 2 Display Window | 6 ■ (STOP) |
| 3 Remote Sensor | 7 ⏻ (POWER) Button |
| 4 ▲ (OPEN/CLOSE) | 8 USB Port |

Rear panel

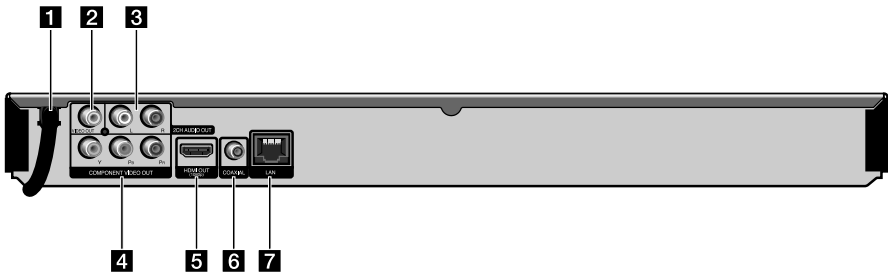

- | | |
|--|---|
| 1 AC power cord | 5 HDMI OUT (Type A, Version 1.3) |
| 2 VIDEO OUT | 6 DIGITAL AUDIO OUT (COAXIAL) |
| 3 2CH AUDIO OUT (Left/Right) | 7 LAN port |
| 4 COMPONENT VIDEO OUT (Y Pb Pr) | |

3 Installation

Connecting to Your TV

Make one of the following connections, depending on the capabilities of your existing equipment.

- HDMI connection (page 14-15)
- Component Video connection (page 16)
- Video connection (page 16)

! NOTE

- Depending on your TV and other equipment you wish to connect, there are various ways you could connect the player. Use only one of the connections described in this manual.
- Please refer to the manuals of your TV, Stereo System or other devices as necessary to make the best connections.
- Do not connect the player's AUDIO OUT jack to the phono in jack (record player) of your audio system.
- Do not connect your player via your VCR. The image could be distorted by the copy protection system.

HDMI Connection

If you have a HDMI TV or monitor, you can connect it to this player using a HDMI cable (Type A, Version 1.3). Connect the HDMI jack on the player to the HDMI jack on a HDMI compatible TV or monitor.

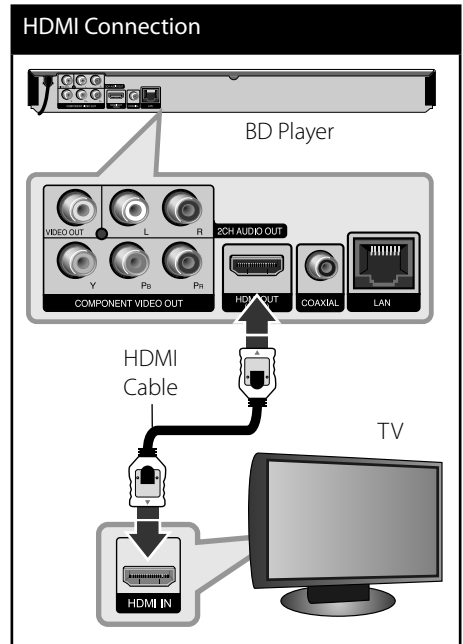

Set the TV's source to HDMI (refer to TV's Owner's manual).

**NOTE**

- If a connected HDMI device does not accept the audio output of the player, the HDMI device's audio sound may be distorted or may not output.
- When you use HDMI connection, you can change the resolution for the HDMI output. (Refer to "Resolution Setting" on page 17.)
- Select the type of video output from the HDMI OUT jack using [HDMI Color Setting] option on the [Setup] menu (see page 26).
- Changing the resolution when the connection has already been established may result in malfunctions. To solve the problem, turn off the player and then turn it on again.
- When the HDMI connection with HDCP is not verified, TV screen is changed to black screen. In this case, check the HDMI connection, or disconnect the HDMI cable.
- If there are noises or lines on the screen, please check the HDMI cable (length is generally limited to 4.5 m (15 ft)).

Additional Information for HDMI

- When you connect a HDMI or DVI compatible device make sure of the following:
 - Try switching of the HDMI/DVI device and this player. Next, switch on the HDMI/DVI device and leave it for around 30 seconds, then switch on this player.
 - The connected device's video input is set correctly for this unit.
 - The connected device is compatible with 720x**576p**, 1280x720p, 1920x1080i or 1920x1080p video input.
- Not all HDCP-compatible HDMI or DVI devices will work with this player.
 - The picture will not be displayed properly with non-HDCP device.
 - This player does not playback and TV screen is changed to black screen.

What is SIMPLINK?

Some functions of this unit are controlled by the TV's remote control when this unit and LG TV's with SIMPLINK are connected through HDMI connection.

Controllable functions by LG TV's remote control; Play, Pause, Scan, Skip, Stop, Power Of, etc.

Refer to the TV owner's manual for the details of SIMPLINK function.

LG TV's with SIMPLINK function has the logo as shown above.

**NOTE**

Depending on the disc type or playing status, some SIMPLINK operation may differ from your purpose or not work.

Component Video Connection

Connect the COMPONENT VIDEO OUT jacks on the player to the corresponding input jacks on the TV using component video cable. Connect the left and right AUDIO OUT jacks of the player to the audio left and right IN jacks on the TV using the audio cables.

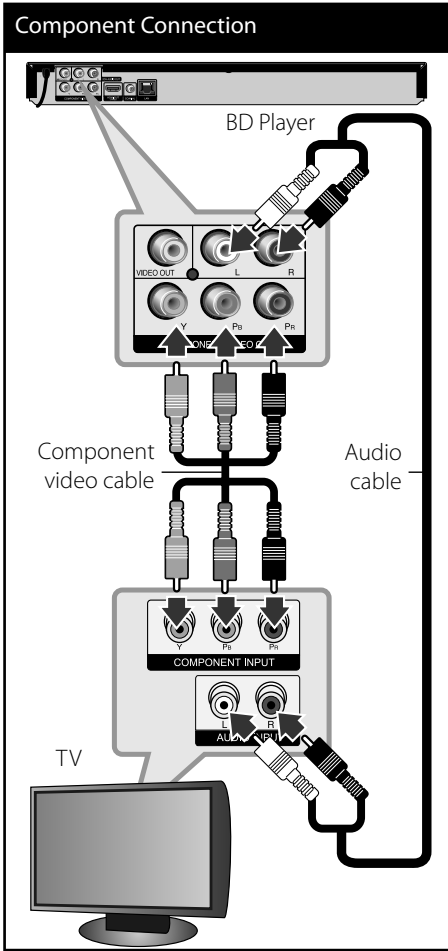

NOTE

When you use COMPONENT VIDEO OUT connection, you can change the resolution for the output. (Refer to "Resolution setting" on page 17.)

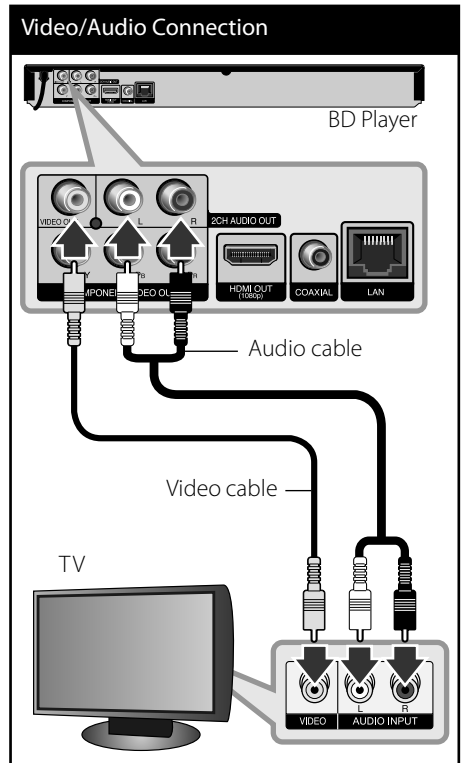

Video/Audio (Left/Right) Connection

Connect the VIDEO OUT jack on the player to the video in jack on the TV using a video cable. Connect the left and right AUDIO OUT jacks of the player to the audio left and right IN jacks on the TV using the audio cables.



Resolution Setting

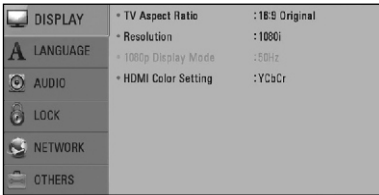

The player provides several output resolutions for HDMI OUT and COMPONENT VIDEO OUT jacks. You can change the resolution using [Setup] menu.

1. Press HOME ().
2. Use  to select the [Setup] and press ENTER (). The [Setup] menu appears.





3. Use  to select [DISPLAY] option then press  to move to the second level.



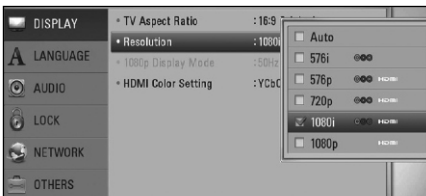

4. Use  to select the [Resolution] option then press ENTER () to move to the third level.



5. Use  to select the desired resolution then press ENTER () to confirm your selection.

NOTE

- If your TV does not accept the resolution you have set on the player, you can set resolution to **576p** as follows:
 1. Press  to open the disc tray.
 2. Press  (STOP) for more than 5 seconds.
- Since several factors affect the resolution of video output, see "Video Output Resolution" on page 58.
- **When you set the HDMI Resolution, over 720p is not outputted to Composit Video.**

Connecting to an Amplifier

Make one of the following connections, depending on the capabilities of your existing equipment.

- HDMI Audio connection (page 18)
- Digital Audio connection (page 19)
- 2CH Analog Audio connection (page 19)

Since many factors affect the type of audio output, see "Audio Output Specifications" for details (pages 56-57)

About Digital Multi-channel sound

A digital multichannel connection provides the best sound quality. For this, you need a multi-channel Audio/Video Receiver that supports one or more of the audio formats supported by your player. Check the receiver manual and the logos on the front of the receiver. (PCM Stereo, PCM Multi-Ch, Dolby Digital, Dolby Digital Plus, Dolby TrueHD, DTS and/or DTS-HD)

Connecting to an Amplifier via HDMI Output

Connect the player's HDMI OUT jack to the corresponding in jack on your amplifier using a HDMI cable. You will need to activate the player's digital output. (See "[AUDIO] Menu" on pages 27-28.)

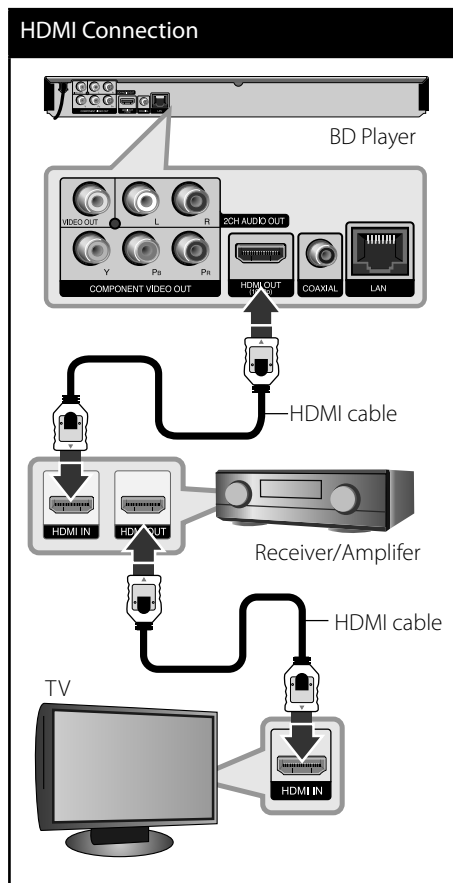

Connect the amplifier's HDMI output jack to HDMI input jack on your TV using a HDMI cable if your amplifier has HDMI output jack.

Connecting to an Amplifier via Digital Audio Output

Connect the player's DIGITAL AUDIO OUT jack to the corresponding in jack (COAXIAL) on your amplifier. Use an optional digital audio cable. You will need to activate the player's digital output. (See "[AUDIO] Menu" on pages 27-28.)

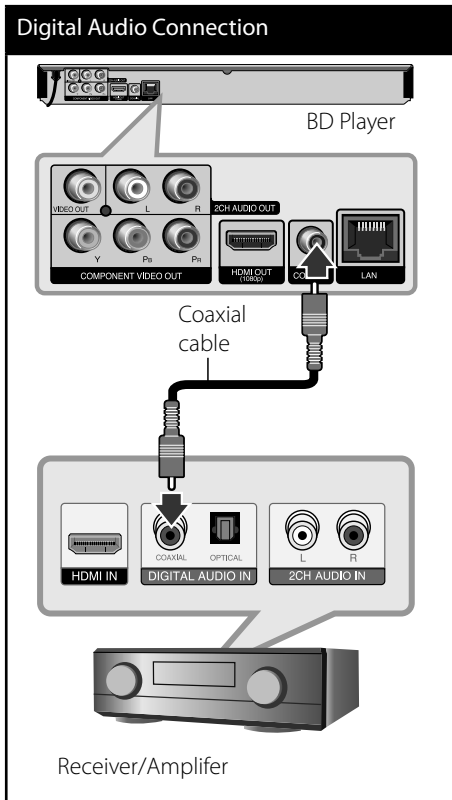

Connecting to an Amplifier via 2 Channel Audio Output

Connect the Left and Right 2CH AUDIO OUT jacks on the player to the audio left and right in jacks on your amplifier, receiver, or stereo system using audio cables.

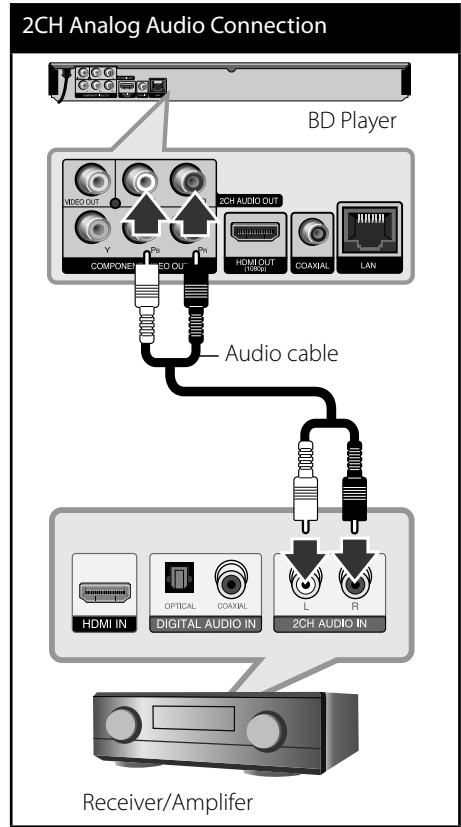

Connecting to your Home Network

This player can be connected to a local area network (LAN) via the LAN port on the rear panel.

By connecting the unit to a broadband home network, you have access to services such as software updates, BD-LIVE interactivity and streaming services.

Network connection

Connect the player's LAN port to the corresponding port on your Modem or Router using a commercially available LAN or Ethernet cable (CAT5 or better with RJ45 connector).



NOTE

- When plugging or unplugging the LAN cable, hold the plug portion of the cable. When unplugging, do not pull on the LAN cable but unplug while pressing down on the lock.
- Do not connect a modular phone cable to the LAN port.
- Since there are various connection configurations, please follow the specifications of your telecommunication carrier or internet service provider.

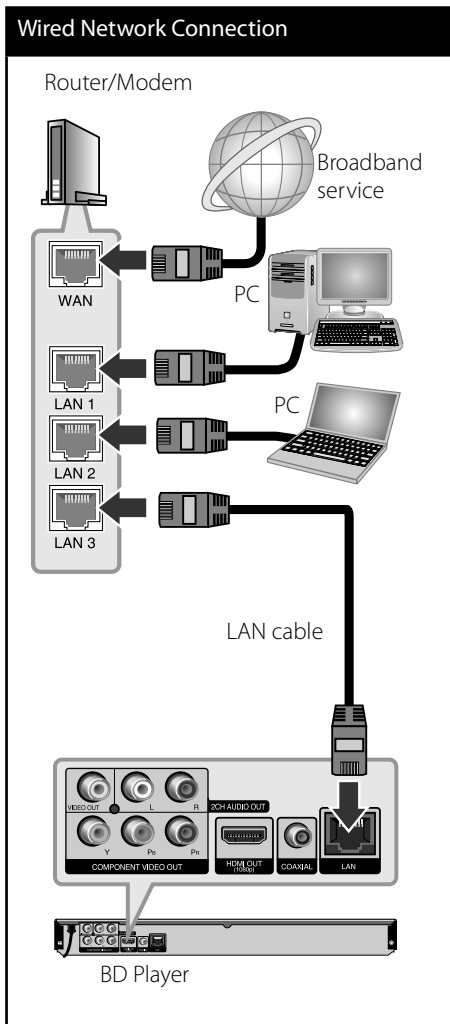

Wired Network Setup

If there is a DHCP server on the local area network (LAN) via wired connection, this player will automatically be allocated an IP address. After making the physical connection, a small number of home networks may require the player's network setting to be adjusted. Adjust the [NETWORK] setting as follow.

Preparation

Before setting the wired network, you need to connect the broadband internet to your home network.

1. Select [Connection Setting] option in the [Setup] menu then press ENTER (⊙).

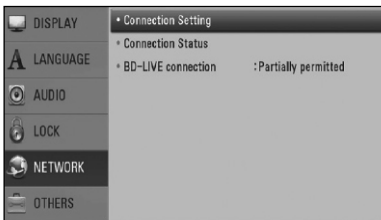

2. Use ▲▼◀▶ to select the IP mode between [Dynamic] and [Static]. Normally, select [Dynamic] to allocate an IP address automatically.

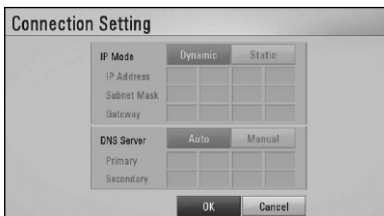

NOTE

If there is no DHCP server on the network and you want to set the IP address manually, select [Static] then set [IP Address], [Subnet Mask], [Gateway] and [DNS Server] using ▲▼◀▶ and numerical buttons. If you make a mistake while entering a number, press CLEAR to clear the highlighted part.

3. Select [OK] and press ENTER (⊙) to apply network settings.
4. The player will ask you to test the network connection. Select [OK] and press ENTER (⊙) to complete the network connection.
5. If you select [Test] and press ENTER (⊙) at step 4 above, the network connection status is displayed on the screen. You can also test it on the [Connection Status] in the [Setup] menu.

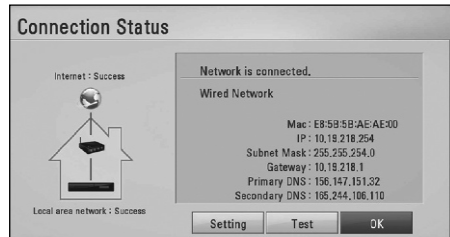

Notes on Network Connection:

- Many network connection problems during set up can often be fixed by re-setting the router or modem. After connecting the player to the home network, quickly power of and/or disconnect the power cable of the home network router or cable modem. Then power on and/or connect the power cable again.
- Depending on the internet service provider (ISP), the number of devices that can receive internet service may be limited by the applicable terms of service. For details, contact your ISP.
- Our company is not responsible for any malfunction of the player and/or the internet connection feature due to communication errors/malfunctions associated with your broadband internet connection, or other connected equipment.
- The features of BD-ROM discs made available through the Internet Connection feature are not created or provided by our company, and our company is not responsible for their functionality or continued availability. Some disc related material available by the Internet Connection may not be compatible with this player. If you have questions about such content, please contact the producer of the disc.
- Some internet contents may require a higher bandwidth connection.
- Even if the player is properly connected and configured, some internet contents may not operate properly because of internet congestion, the quality or bandwidth of your internet service, or problems at the provider of the content.
- Some internet connection operations may not be possible due to certain restrictions set by the Internet service provider (ISP) supplying your broadband Internet connection.
- Any fees charged by an ISP including, without limitation, connection charges are your responsibility.
- A 10 Base-T or 100 Base-TX LAN port is required for wired connection to this player. If your internet service does not allow for such a connection, you will not be able to connect the player.
- You must use a Router to use xDSL service.
- A DSL modem is required to use DSL service and a cable modem is required to use cable modem service. Depending on the access method of and subscriber agreement with your ISP, you may not be able to use the internet connection feature contained in this player or you may be limited to the number of devices you can connect at the same time. (If your ISP limits subscription to one device, this player may not be allowed to connect when a PC is already connected.)
- The use of a "Router" may not be allowed or its usage may be limited depending on the policies and restrictions of your ISP. For details, contact your ISP directly.

USB device connection

This player can play movie, music and photo files contained in the USB device.

Playback content in the USB device

1. Insert a USB device to the USB port until it fits into place.

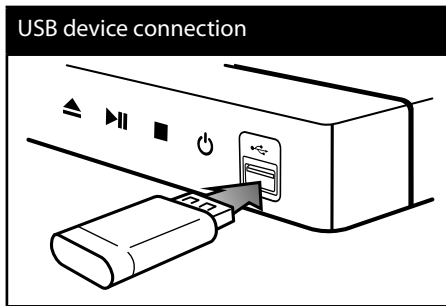

When you connect a USB storage device on the HOME menu, the player plays a audio file contained in the USB storage device automatically. If the USB storage device is containing various types of files, a menu for the file type selection will appear.

File loading may takes few minutes depending on the number of content stored in the USB storage device. Press ENTER (⊙) while [Cancel] is selected to stop loading.

2. Press HOME (🏠).

3. Select [Movie],[Photo] or [Music] using ◀▶, and press ENTER (⊙).

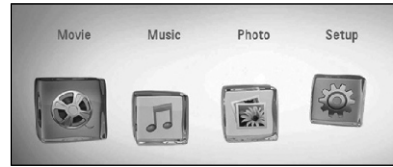

4. Select the [USB] option using ◀▶, and press ENTER (⊙).

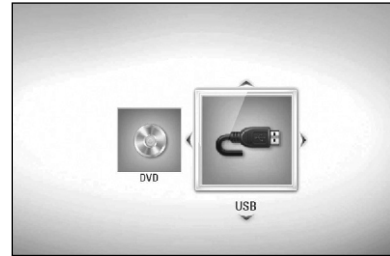

5. Select a file using ▲▼◀▶, and press PLAY or ENTER (⊙) to play the file.

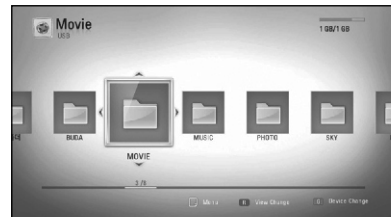

6. Withdraw the USB device carefully.

NOTE

- This player supports USB flash drive/external HDD formatted in FAT16, FAT32 and NTFS when accessing files (movie, music, photo). However, for BD-LIVE and Audio CD recording, only FAT16 and FAT32 formats are supported. Use the USB flash drive/external HDD formatted in either FAT16 or FAT32 when using BD-LIVE and Audio CD recording.
- The USB device can be used for the local storage for enjoying BD-LIVE discs with Internet.
- This unit can support up to 4 partitions of the USB device.
- Do not extract the USB device during operation (play, etc.).
- A USB device which requires additional program installation when you have connected it to a computer, is not supported.
- USB device: USB device that supports USB1.1 and USB2.0.
- Movie, Music and photo files can be played. For details of operations on each file, refer to relevant pages.
- Regular back up is recommended to prevent data loss.
- If you use a USB extension cable, USB HUB or USB Multi-reader, the USB device may not be recognized.
- Some USB device may not work with this unit.
- Digital camera and mobile phone are not supported.
- USB Port of the unit cannot be connected to PC. The unit cannot be used as a storage device.

Settings

Adjust the Setup Settings

You can change the settings of the player in the [Setup] menu.

1. Press HOME (🏠).

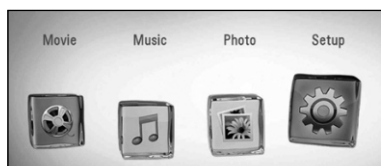

2. Use ◀▶ to select the [Setup] and press ENTER (⊙). The [Setup] menu appears.

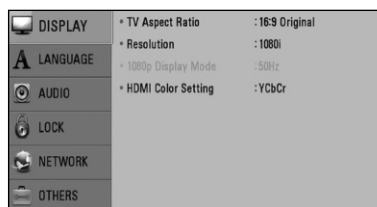

3. Use ▲▼ to select the first setup option, and press ▶ to move to the second level.



4. Use ▲▼ to select a second setup option, and press ENTER (Ⓞ) to move to the third level.



5. Use ▲▼ to select a desired setting, and press ENTER (Ⓞ) to confirm your selection.



[DISPLAY] Menu

TV Aspect Ratio

Select a TV aspect ratio option according to your TV type.

[4:3 Letter Box]

Select when a standard 4:3 TV is connected. Displays theatrical images with masking bars above and below the picture.

[4:3 Pan Scan]

Select when a standard 4:3 TV is connected. Displays pictures cropped to fill your TV screen. Both sides of the picture are cut off.

[16:9 Original]

Select when a 16:9 wide TV is connected. The 4:3 picture is displayed with an original 4:3 aspect ratio, with black bars appearing at the left and right sides.

[16:9 Full]

Select when a 16:9 wide TV is connected. The 4:3 picture is adjusted horizontally (in a linear proportion) to fill the entire screen.



NOTE

You cannot select [4:3 Letter Box] and [4:3 Pan Scan] option when the resolution is set to higher than 720p.

Resolution

Sets the output resolution of the Component and HDMI video signal. Refer to page 17 and 58 for details about the resolution setting.

[Auto]

If the HDMI OUT jack is connected to TVs providing display information (EDID), automatically selects the resolution best suited to the connected TV. If the COMPONENT VIDEO OUT is only connected, this changes the resolution to 1080i as default resolution.

[1080p]

Outputs 1080 lines of progressive video.

[1080i]

Outputs 1080 lines of interlaced video.

[720p]

Outputs 720 lines of progressive video.

[576p]

Outputs **576** lines of progressive video.

[576i]

Outputs **576** lines of interlaced video.

1080p Display Mode

When the resolution is set to 1080p, select [24Hz] for smooth presentation of film material (1080p/24 Hz) with a HDMI-equipped display compatible with 1080p/24 Hz input.



NOTE

- When you select [24 Hz], you may experience some picture disturbance when the video switches video and film material. In this case, select **[50 Hz]**.
- Even when [1080p Display Mode] is set to [24 Hz], if your TV is not compatible with 1080p/24 Hz, the actual frame frequency of the video output will be **50 Hz** to match the video source format.

HDMI Color Setting

Select the type of output from the HDMI OUT jack. For this setting, please refer to the manuals of your display device.

[YCbCr]

Select when connecting to a HDMI display device.

[RGB]

Select when connecting to a DVI display device.



[LANGUAGE] Menu

Display Menu

Select a language for the [Setup] menu and on-screen display.

Disc Menu/Disc Audio/ Disc Subtitle

Select the language you prefer for the audio track (disc audio), subtitles, and the disc menu.

[Original]

Refers to the original language in which the disc was recorded.

[Other]

Press ENTER (⊙) to select another language. Use number buttons then press ENTER (⊙) to enter the corresponding 4-digit number according to the language code list on page 54.

[Of] (Disc Subtitle only)

Turn of Subtitle.



NOTE

Depending on the disc, your language setting may not work.



[AUDIO] Menu

Each disc has a variety of audio output options. Set the player's Audio options according to the type of audio system you use.



NOTE

Since many factors affect the type of audio output, see "Audio Output Specifications" on page 56-57 for details.



NOTE

- When [HDMI] option is set to [PCM Multi-Ch], the audio may output as PCM Stereo if the PCM Multi-Ch information is not detected from HDMI device with EDID.
- If the [HDMI] or [Digital Output (SPDIF)] option is set to [DTS Re-Encode], the DTS Re-Encode audio is outputted for BD-ROM discs with secondary audio and the original audio is outputted for the other discs (like [Primary Pass-Thru]).

HDMI / Digital Output (SPDIF)

Select the output sound format when a device equipped with a HDMI or Digital Audio input jack is connected to the HDMI OUT or DIGITAL AUDIO OUT jack on this player.

[PCM Stereo]

Select if you connect this unit's HDMI OUT or DIGITAL AUDIO OUT jack to a device with two-channel digital stereo decoder.

[PCM Multi-Ch] (HDMI only)

Select if you connect this unit's HDMI OUT jack to a device with multi-channel digital decoder.

[DTS Re-Encode]

Select if you connect this unit's HDMI OUT or DIGITAL AUDIO OUT jack to a device with DTS decoder.

[Primary Pass-Thru]

Select if you connect this unit's DIGITAL AUDIO OUT and HDMI OUT jack to a device with LPCM, Dolby Digital, Dolby Digital Plus, Dolby TrueHD, DTS and DTS-HD decoder.

Sampling Freq. (Digital Audio Output)

[192 kHz]

Select this if your A/V Receiver or Amplifier is capable of handling 192 kHz signals.

[96 kHz]

Select this if your A/V Receiver or Amplifier is not capable of handling 192 kHz signals. When this choice is made, this unit automatically converts any 192 kHz signals to 96 kHz so your system can decode them.

[48 kHz]

Select this if your A/V Receiver or Amplifier is not capable of handling 192 kHz and 96 kHz signal. When this choice is made, this unit automatically converts any 192 kHz and 96 kHz signals to 48 kHz so your system can decode them.

Check the documentation for your A/V Receiver or Amplifier to verify its capabilities.

DRC (Dynamic Range Control)

This function allows you to listen to a movie at a lower volume without losing clarity of sound.

[Of]

Turns off this function.

[On]

Compress the dynamic range of the Dolby Digital, Dolby Digital Plus or Dolby TrueHD audio output.

[Auto]

The dynamic range of the Dolby TrueHD audio output is specified by itself. And the dynamic range of the Dolby Digital and Dolby Digital Plus are operated as same as the [On] mode.



NOTE

The DRC setting can be changed only when a disc is not inserted or the unit is in complete stop mode.

DTS Neo:6

If the player is connected to the multi-channel Audio Receiver by HDMI connection, set this option to enjoy the multi-channel surround sound with the 2-channel audio source.

[Of]

Outputs the stereo sound via front speakers.

[Music]

Outputs the multi-channel sounds that are optimized for listening to music.

[Cinema]

Outputs the multi-channel sounds that are optimized for watching movie.



NOTE

- This function is not available on an on-line service.
- Only the audio source with less than 48 kHz sampling frequency is available for this function.
- This function is available only when [HDMI] option is set to [PCM Multi-Ch].



[LOCK] Menu

The [LOCK] settings affect only BD and DVD playback.

To access the any features in [LOCK] settings, you must enter the 4-digit security code you have created.

If you have not entered a password yet, you are prompted to do so. Enter a 4-digit password twice, and press ENTER (⊙) to create a new password.

Password

You can create or change the password.

[None]

Enter a 4-digit password twice, and press ENTER (⊙) to create a new password.

[Change]

Enter the current password and press ENTER (⊙). Enter a 4-digit password twice, and press ENTER (⊙) to create a new password.

If you forget your password

If you forget your password, you can clear it using the following steps:

1. Remove any disc that might be in the player.
2. Select [Password] option in the [Setup] menu.
3. Use Number buttons to enter "210499". The password is cleared.



NOTE

If you make a mistake before pressing ENTER (⊙), press CLEAR. Then input the correct password.

DVD Rating

Blocks playback of rated DVD based on their content. (Not all discs are rated.)

[Rating 1-8]

Rating one (1) has the most restrictions and rating eight (8) is the least restrictive.

[Unlock]

If you select [Unlock], parental control is not active and the disc plays in full.

BD Rating

Set an age limit of BD-ROM play. Use number buttons to input an age limit for BD-ROM viewing.

[255]

All BD-ROM can be played.

[0-254]

Prohibits play of BD-ROM with corresponding ratings recorded on them.



NOTE

The [BD Rating] will be applied only for the BD disc that containing the Advanced Rating Control.

Area Code

Enter the code of the area whose standards were used to rate the DVD video disc, based on the list on page 53.



[NETWORK] Menu

The [NETWORK] settings are needed to use the software update and BD Live .

Connection Setting

If your home network environment is ready to connect the player, the player needs to be set the wired network connection for network communication. (See "Connecting to your Home Network" on pages 20-22.)

Connection Status

If you want to check the network status on this player, select the [Connection Status] options and press ENTER (⊙) to check whether a connection to the network and the internet have been established.

BD-LIVE connection

You can restrict Internet access when BD-LIVE functions are used.

[Permitted]

Internet access is permitted for all BD-LIVE contents.

[Partially permitted]

Internet access is permitted only for BD-LIVE contents which have content owner certificates. Internet access and AACs Online functions are prohibited for all BD-LIVE contents without a certificate.

[Prohibited]

Internet access is prohibited for all BD-LIVE contents.



[OTHERS] Menu

DivX VOD

ABOUT DIVX VIDEO: DivX® is a digital video format created by DivX, Inc. This is an official DivX Certified device that plays DivX video. Visit www.divx.com for more information and software tools to convert your files into DivX video.

ABOUT DIVX VIDEO-ON-DEMAND: This DivX Certified® device must be registered in order to play DivX Video-on-Demand (VOD) content. To generate the registration code, locate the DivX VOD section in the device setup menu. Go to vod.divx.com with this code to complete the registration process and learn more about DivX VOD.

[Register]

Displays the registration code of your player.

[Deregister]

Deactivate your player and display the deactivation code.



NOTE

All the downloaded videos from DivX VOD with this player's registration code can only be played back on this unit.

Auto Power Off

The screen saver appears when you leave the player in Stop mode for about five minutes. If you set this option to [On], the unit automatically turns itself off after the Screen Saver is displayed for 25 minutes. Set this option to [Of] to leave the screen saver until the unit is operated by the user.

Initialize

Factory Set

You can reset the player to its original factory settings.

BD Storage Clear

Initializes the BD contents from the connected USB storage.



NOTE

If you reset the player to its original factory settings using [Factory Set] option, you have to set the network settings again.

Software

Information

Displays the current software version.

Update

You can update the software by connecting the unit directly to the software update server (see page 51-52).

Disclaimer Notice

Press ENTER (⊙) to view the notice of Network Service Disclaimer on page 60.

4 Operation

General Playback

Playing Discs

1. Press **▲** (OPEN/CLOSE), and place a disc on the disc tray.

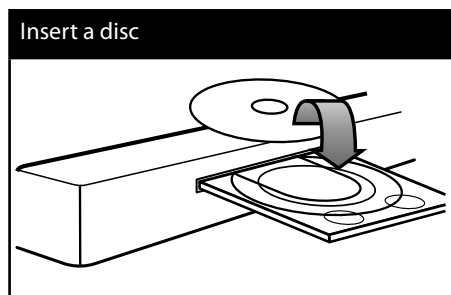

2. Press **▲** (OPEN/CLOSE) to close the disc tray.

For the most Audio CD, BD-ROM and DVD-ROM discs, playback starts automatically.

3. Press HOME (**🏠**).



4. Select [Movie], [Photo] or [Music] using **◀▶**, and press ENTER (**⊙**).

5. Select the [Disc] option using **◀▶**, and press ENTER (**⊙**).

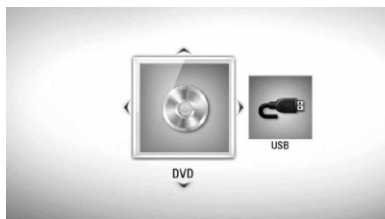

This step is needed only when a disc and a USB device is connected simultaneously in this unit.

6. Select a file using **▲▼◀▶**, and press **▶** (PLAY) or ENTER (**⊙**) to play the file.

! NOTE

- Playback functions described in this manual are not always available in every files and media. Some functions can be restricted depending on many factors.
- Depending on the BD-ROM titles, a USB device connection may be needed for the proper playback.

To stop playback

Press **■** (STOP) while playback.

To pause playback

Press **⏸** (PAUSE) while playback.
Press **▶** (PLAY) to resume playback.

To play frame-by-frame

Press **⏸** (PAUSE) while movie playback.
Press **⏸** (PAUSE) repeatedly to play Frame-by-Frame playback.

To scan forward or backward

Press **⏮** or **⏭** (SCAN) to play fast forward or fast reverse during playback.
You can change the various playback speeds by pressing **⏮** or **⏭** (SCAN) repeatedly.

To slow down the playing speed

While the playback is paused, press **⏭** (SCAN) repeatedly to play various speeds of slow motion.

To skip to the next/previous chapter/track/file

During playback, press **⏮** or **⏭** (SKIP) to go to the next chapter/track/file or to return to the beginning of the current chapter/track/file.
Press **⏮** (SKIP) twice briefly to step back to the previous chapter/track/file.

Using the disc menu

BD **DVD** **AVCHD**

To display the disc menu

The menu screen may be displayed first after loading a disc which contains a menu. If you want to display the disc menu while playback, press DISC MENU.

Use **▲▼◀▶** buttons to navigate through menu items.

To display the Pop-up menu

Some BD-ROM discs contain Pop-up menu that appears while playback.

Press TITLE/POPOP while playback, and use **▲▼◀▶** buttons to navigate through menu items.

Resume playback

BD **DVD** **AVCHD** **ACD** **MUSIC**
MOVIE

The unit records the point where you pressed the **■** (STOP) depending on the disc. If "**⏸** **■** (Resume Stop)" appears on the screen briefly, press **▶** (PLAY) to resume playback (from the scene point).

If you press **■** (STOP) twice or unload the disc, "**■** (Complete Stop)" appears on the screen. The unit will clear the stopped point.



NOTE

- The resume point may be cleared when a button is pressed (for example; **⏻** (POWER), **▲** (OPEN/CLOSE), etc).
- On BD-Video discs with BD-J, the resume playback function does not work.
- If you press **■** (STOP) once during BD-ROM interactive title playback, the unit will be in Complete Stop mode .

Advanced Playback

Repeat Playback

BD DVD AVCHD ACD MUSIC

During playback, press REPEAT repeatedly to select a desired repeat mode.

BDs/DVDs

 **A-** – Selected portion will be repeated continually.

 **Chapter** – The current chapter will be played back repeatedly.

 **Title** – The current title will be played back repeatedly.

To return to normal playback, press REPEAT repeatedly to select [Of].

Audio CDs/Audio files

 **Track** – The current track or file will be played back repeatedly.

 **All** – All the tracks or files will be played back repeatedly.

 – The tracks or files will be played back in random order.

 **All** – All the tracks or files will be played back repeatedly in random order.

 **A-B** – Selected portion will be repeated continually. (Audio CD only)

To return to normal playback, press CLEAR.



NOTE

- If you press **▶▶ SKIP** once during Repeat Chapter/Track playback, the repeat playback cancels.
- This function may not work on some disc or title.

Repeating a specific portion

BD DVD AVCHD ACD

This player can repeat a portion you have selected.

1. While playback, press REPEAT to select [A-] at the beginning of the portion you wish to repeat.
2. Press ENTER () at the end of the portion. Your selected portion will be repeated continually.
3. To return to normal playback, press REPEAT repeatedly to select [Of].





NOTE

- You cannot select a portion less than 3 seconds.
- This function may not work on some disc or title.

Enlarge the playback image

BD DVD AVCHD PHOTO MOVIE

1. During playback or pause mode, press ZOOM to display the [Zoom] menu.
2. Use red (R) or green (G) colored button to zoom out or in the picture. You can move through the zoomed picture using   buttons.
3. To return to the normal picture size, press yellow (Y) colored button.
4. Press RETURN () to exit the [Zoom] menu.

Marker Search

BD DVD AVCHD MOVIE

You can start playback from up to nine memorized points.

To enter a marker

1. While playback, press **MARKER** at the desired point. The Marker icon appears on the TV screen briefly.
2. Repeat step 1 to add up to nine markers.

To recall a marked scene

1. Press **SEARCH** and the search menu appears on the screen.
2. Press a number button to select a marker number that you want to recall. Playback starts from the marked scene.

To delete a Marker

1. Press **SEARCH** and the search menu appears on the screen.

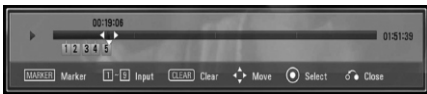

2. Press **▼** to highlight a marker number. Use **◀▶** to select a marked scene that you want to delete.
3. Press **CLEAR** and the marked scene is erased from the search menu.

NOTE

- This function may not work on some disc or title.
- All marked points are cleared if the title is in complete stop (■) mode, the title is changed or if you unload the disc.
- If the total length of the title is less than 10 seconds, this function is not available.

Using the search menu

BD DVD AVCHD MOVIE

Using search menu, you can easily find the point where you want to start playback.

To search a point

1. During playback, press **SEARCH** to display the search menu.



2. Press **◀▶** to skip the playback 15 seconds forward or backward. You can select a point that you want to skip by pressing and holding **◀▶** button.

To start playback from a marked scene

1. Press **SEARCH** and the search menu appears on the screen.
2. Press **▼** to highlight a marker number. Use **◀▶** to select a marked scene that you want to start playback.
3. Press **ENTER** (⊙) to start playback from the marked scene.

NOTE

This function may not work on some disc or title.

Changing content list view

MUSIC PHOTO MOVIE



On the [Movie] [Music] or [Photo] menu, you can change the content list view.

Method 1

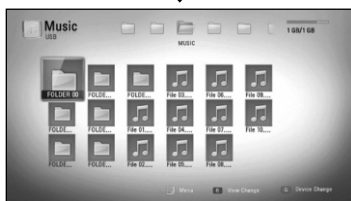
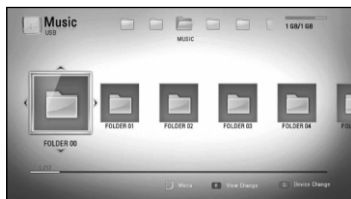
Press red (R) colored button repeatedly.





Method 2

1. On the content list, press INFO/DISPLAY () to display the option menu.
2. Use **▲▼** to select the [View Change] option.
3. Press ENTER () to change the content list view.

Viewing content information

MOVIE

The player can display the content information.

1. Select a file using **▲▼◀▶**.
2. Press INFO/DISPLAY () to display the option menu.
3. Select the [Information] option using **▲▼**, and press ENTER ().

The file information appears on the screen.

During movie playback, you can display the file information by pressing TITLE/POPUP.

NOTE

The information displayed on the screen may not be correct compared to the actual content information.

Last Scene Memory

BD DVD

This unit memorizes the last scene from the last disc that is viewed. The last scene remains in memory even if you remove the disc from the unit or switch of the unit. If you load a disc that has the scene memorized, the scene is automatically recalled.

NOTE

- Last Scene Memory function for a previous disc is erased once a different disc is played.
- This function may not work depending on the disc.
- On BD-Video discs with BD-J, the last scene memory function does not work.
- This unit does not memorize settings of a disc if you switch of the unit before commencing to play it.

On-Screen display

You can display and adjust various information and settings about the content.

Displaying content information on-screen

BD **DVD** **AVCHD** **MOVIE**

1. While playback, press INFO/DISPLAY () to show various playback information.

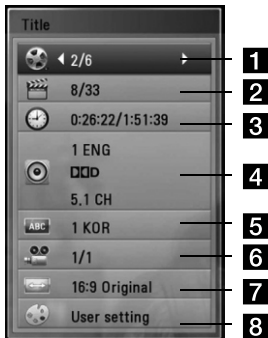

- 1 Title – current title number/total number of titles
- 2 Chapter – current chapter number/total number of chapters
- 3 Time – elapsed playing time/total playback time
- 4 Audio – selected audio language or channel
- 5 Subtitle – selected subtitle
- 6 Angle – selected angle/total number of angles
- 7 TV Aspect Ratio – selected TV aspect Ratio
- 8 Picture Mode – selected picture mode



2. Select an option using **▲▼**.
3. Use **◀▶** to adjust the selected option value.
4. Press RETURN() to exit the On-Screen display.

NOTE

- If no button is pressed for a few seconds, the on-screen display disappears.
- A title number cannot be selected on some discs.
- Available items may differ depending on discs or titles.
- If BD interactive title is playing back, some setting information is displayed on the screen but prohibited to be changed.

Playing from selected time

BD **DVD** **AVCHD** **MOVIE**

1. Press INFO/DISPLAY () during playback. The time search box shows the elapsed playing time.
2. Select the [Time] option and then input the required start time in hours, minutes, and seconds from left to right.
For example, to find a scene at 2 hours, 10 minutes, and 20 seconds, enter“21020”.
Press **◀▶** to skip the playback 60 seconds forward or backward.
3. Press ENTER () to start playback from selected time.

NOTE

This function may not work on some disc or titles.

Hearing a different audio

BD **DVD** **AVCHD** **MOVIE**



1. During playback, press INFO/DISPLAY () to display the On-Screen display.
2. Use **▲▼** to select the [Audio] option.
3. Use **◀▶** to select desired audio language, audio track or audio channel.

! NOTE

- Some discs allow you to change audio selections only via the disc menu. In this case, press TITLE/POP-UP or DISC MENU button and choose the appropriate audio from the selections on the disc menu.
- Immediately after you have switched sound, there may be a temporary discrepancy between the display and actual sound.
- On BD-ROM disc, the multi audio format (5.1CH or 7.1CH) is displayed with [MultiCH] in the on-screen display.

Selecting a subtitle language

BD **DVD** **AVCHD** **MOVIE**

1. During playback, press INFO/DISPLAY () to display the On-Screen display.
2. Use **▲▼** to select the [Subtitle] option.
3. Use **◀▶** to select desired subtitle language.
4. Press RETURN () to exit the On-Screen display.



! NOTE

Some discs allow you to change subtitle selections only via the disc menu. If this is the case, press TITLE/POP-UP or DISC MENU button and choose the appropriate subtitle from the selections on the disc menu.

Watching from a different angle

BD **DVD**



If the disc contains scenes recorded at different camera angles, you can change to a different camera angle during playback.

1. During playback, press INFO/DISPLAY () to display the On-Screen display.
2. Use **▲▼** to select the [Angle] option.
3. Use **◀▶** to select desired angle.
4. Press RETURN () to exit the On-Screen display.

Changing the TV Aspect Ratio

BD **DVD** **AVCHD** **MOVIE**

You can change the TV aspect ratio setting while playback.

1. During playback, press INFO/DISPLAY () to display the On-Screen display.
2. Use **▲▼** to select the [TV Aspect Ratio] option.
3. Use **◀▶** to select desired option.
4. Press RETURN () to exit the On-Screen display.

! NOTE

Even if you change the value of the [TV Aspect Ratio] option in On-Screen display, the [TV Aspect Ratio] option in the [Setup] menu is not changed.

Changing the Picture Mode

BD DVD AVCHD MOVIE

You can change the [Picture mode] option while playback.

1. During playback, press INFO/DISPLAY (ⓘ) to display the On-Screen display.
2. Use ▲▼ to select the [Picture Mode] option.
3. Use ◀▶ to select desired option.
4. Press RETURN (↵) to exit the On-Screen display.

Setting the [User] option

1. During playback, press INFO/DISPLAY (ⓘ) to display the On-Screen display.
2. Use ▲▼ to select the [Picture Mode] option.
3. Use ◀▶ to select the [User setting] option, and press ENTER (Ⓞ).

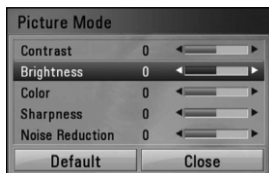

4. Use ▲▼◀▶ to adjust the [Picture Mode] options.
Select [Default] option then press ENTER (Ⓞ) to reset the all video adjustments.
5. Use ▲▼◀▶ to select the [Close] option, and press ENTER (Ⓞ) to finish setting.

Enjoying BD-LIVE

This unit allows you to enjoy functions such as picture-in-picture, secondary audio and Virtual packages, etc., with BD-Video supporting BONUSVIEW (BD-ROM version 2 Profile 1 version 1.1/ Final Standard Profile). Secondary video and audio can be played from a disc compatible with the picture-in-picture function. For the playback method, refer to the instructions in the disc.

In addition to the BONUSVIEW function, BD-Video supporting BD-LIVE (BD-ROM version 2 Profile 2) that has a network extension function allows you to enjoy more functions such as downloading new movie trailers by connecting this unit to the internet.

1. Check the network connection and settings (pages 20-22).
2. Insert a USB storage device to the USB port on the front panel.

A USB storage device is needed to download bonus content.

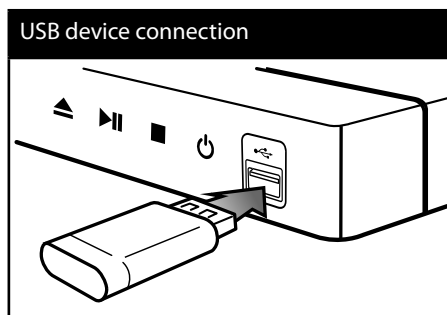

3. Press HOME (), and set the [BD-LIVE connection] option on the [Setup] menu (page 30).

Depending on a disc, the BD-LIVE function may not be operated if [BD-LIVE connection] option is set to [Partially Permitted].

4. Insert a BD-ROM with BD-LIVE.

The operations are differ depending on the disc. Refer to the manual supplied with the disc.



CAUTION

Do not extract the connected USB device while content is being downloaded or a Blu-ray disc is still in the disc tray. Doing so may damage the connected USB device and BD-LIVE features may not operate properly with the damaged USB device anymore. If the connected USB device seems damaged from such an action, you can format the connected USB device from the PC and reuse it with this player.



NOTE

- Some BD-LIVE contents may be restrictively accessed in some territories by contents provider's own decision.
- **It may take up to several minutes to load and start enjoying BD-LIVE contents.**



Playing a movie file and VR disc

You can play DVD-RW discs that are recorded in Video Recording (VR) format and movie files contained in a disc/USB device.

1. Press HOME ().



2. Select [Movie] using , and press ENTER ().

3. Select [Disc] or [USB] option using , and press ENTER ().



This step is needed only when a disc and a USB device is connected simultaneously to this unit.

4. Select a file using  , and press  (PLAY) or ENTER () to play the file.

NOTE

- The file requirements are described on page 10.
- You can use various playback functions. Refer to pages 32-36.
- Unfinalized DVD VR format discs may not be played in this player.
- Some DVD-VR discs are made with CPRM data by DVD RECORDER. This unit cannot support these kinds of discs.

What is CPRM?

CPRM is a copy protection system (with scramble system) only allowing the recording of 'copy once' broadcast programs. CPRM stands for Content Protection for Recordable Media.

Selecting a subtitle file

MOVIE

If a movie file name and the subtitle file name are the same, subtitle file is played automatically when playing the movie file.

If the subtitle file name is different with the movie file name, you need to select the subtitle file on the [Movie] menu before playing the movie.

1. Use ▲▼◀▶ to select the subtitle file you wish to play in the [Movie] menu.
2. Press ENTER (⊙).



Press ENTER (⊙) again to deselect the subtitle file. Selected subtitle file will be displayed when you play the movie file.

NOTE

If you press ■ (STOP) during playback, the subtitle selection is cancelled.

Changing subtitle code page

MOVIE

If the subtitle is not displayed properly, you can change the subtitle code page to view the subtitle file properly.

1. During playback, press INFO/DISPLAY (⏏) to display the On-Screen display.
2. Use ▲▼ to select the [Code Page] option.
3. Use ◀▶ to select desired code option.







4. Press RETURN (↵) to exit the On-Screen display.

Viewing a photo

You can view photo files using this player.

1. Press HOME ().



2. Select [Photo] using , and press ENTER ().
3. Select [Disc] or [USB] option using , and press ENTER ().

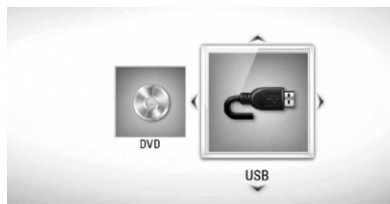

This step is needed only when a disc and a USB device is connected simultaneously on this unit.

4. Select a file using   , and press ENTER () to view the photo.



To play a slide show

Press  (PLAY) to start slide show.

To stop a slide show



Press  (STOP) while slide show.

To pause a slide show

Press  (PAUSE) while slide show.

Press  (PLAY) to re-start the slide show.

To skip to the next/previous photo



While viewing a photo in full screen, press  or  to go to the previous or next photo.

NOTE

- The file requirements are described on page 10.
- You can use various playback functions. Refer to pages 32-36.

Options while viewing a photo

You can use various options during viewing a photo in full screen.

1. While viewing a photo in full screen, press INFO/DISPLAY () to display the option menu.
2. Select an option using  .

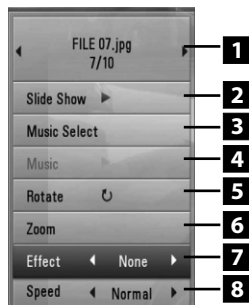

- 1 Current photo/Total number of photos
– Use ◀▶ to view previous/next photo.
 - 2 Slide Show – Press ENTER (⊙) to start or pause slide show.
 - 3 Music Select – Select the background music for the slide show (page 43).
 - 4 Music –Press ENTER (⊙) to start or pause background music.
 - 5 Rotate – Press ENTER (⊙) to rotate the photo clockwise.
 - 6 Zoom – Press ENTER (⊙) to display the [Zoom] menu.
 - 7 Effect – Use ◀▶ to select a transition effect between photos in a slide show.
 - 8 Speed – Use ◀▶ to select a delaying speed between photos in a slide show.
3. Press RETURN(↵) to exit the option menu.

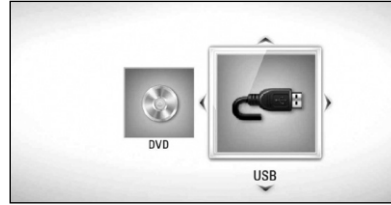

4. Select a file using ▲▼◀▶, and press ENTER (⊙) to view the photo.
5. Press INFO/DISPLAY (ℹ) to display the option menu.
6. Use ▲▼ to select [Music Select] option, and press ENTER (⊙) to display the [Music Select] menu.
7. Use ▲▼ to select a device, and press ENTER (⊙).
8. Use ▲▼ to select a file or a folder you wish to play.

Listening to music while slide show

You can display photo files while listening to audio files.

1. Press HOME (🏠).



2. Select [Photo] using ◀▶, and press ENTER (⊙).
3. Select [Disc] or [USB] option using ◀▶, and press ENTER (⊙).







- Select a folder and press ENTER (⊙) to display the lower directory.
- Select ⏮ and press ENTER (⊙) to display the upper directory.
9. Use ▶ to select [OK], and press ENTER (⊙) to complete music selection.

Listening to music

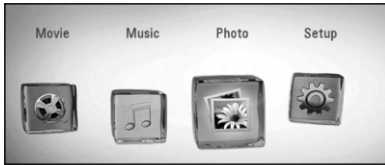
The player can play Audio CDs and audio files.





1. Press HOME ().

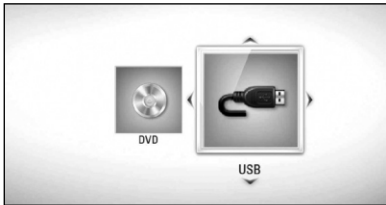

2. Select [Music] using , and press ENTER ().
3. Select the [Disc] or [USB] option using , and press ENTER ().



This step is needed only when a disc and a USB device is connected simultaneously on this unit.



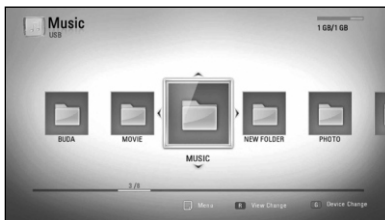

4. Select a music file or audio track using , , , and press ENTER () to play the music.



NOTE

- The file requirements are described on page 10.
- You can use various playback functions. Refer to pages 32-36.

Displaying MP3 music information (ID3 Tag)

1. Select a music file using , .
2. Press DISPLAY/INFO () to display the option menu.
3. Select [Information] option using , and press ENTER ().
4. The music information will be displayed on the screen.





NOTE

Some MP3 files may not work for this function.

Audio CD Recording

You can record one desired track or all of the tracks in Audio CD to a USB storage device.

1. Insert a USB storage device to the USB port on the front panel.
2. Press  (OPEN/CLOSE), and place an Audio CD on the disc tray.
Press  (OPEN/CLOSE) to close the disc tray. The playback starts automatically.

3. Press INFO/DISPLAY to display the option menu.

4. Use ▲▼ to select [CD Recording] option, and press ENTER (⊙) to display the [CD Recording] menu.



5. Use ▲▼ to select a track you wish to copy on the menu, and press ENTER (⊙). Repeat this step to select tracks as many as you can.

Select All	Selects all the tracks on an Audio CD.
Option	Selects an encoding option from the pop-up menu (128kbps, 192kbps, 320kbps or Lossless).
Close	Cancel the recording and returns to the previous screen.

6. Use ▲▼◀▶ to select [Start], and press ENTER (⊙).

7. Use ▲▼◀▶ to select the destination folder to be copied.



If you want to create a new folder, use ▲▼◀▶ to select [New Folder] and press ENTER (⊙).

Enter a folder name using virtual keyboard, and press ENTER (⊙) while [OK] is selected.

8. Use ▲▼◀▶ to select [OK], and press ENTER (⊙) to start Audio CD recording.

If you want to stop in progressing Audio CD recording, press ENTER (⊙) while [Cancel] is highlighted.

9. A message appears when Audio CD recording is completed. Press ENTER (⊙) to check the music file created in the destination folder.

NOTE

- The table below shows the average recording time from an audio track with 4 minutes of playback time to a music file with 192 kbps as an example.

stop mode	while playback
1.4 min.	4 min.

- All times in the above table are approximate.
- Actual recording time for USB storage device varies depending on the USB storage device's ability.
- Make sure that there is minimum of 50 MB free space is needed when recording into the USB storage device.
- The length of the music should be longer than 20 seconds for the proper recording.
- Do not turn of this player or extract the connected USB storage device during Audio CD recording.

The making of unauthorized copies of copy-protected material, including computer programs, files, broadcasts and sound recordings, may be an infringement of copyrights and constitute a criminal offense.

This equipment should not be used for such purposes.

**Be responsible
Respect copyrights**

Using the NetCast™ Entertainment Access

You can use various content services via Internet with the NetCast Entertainment Access feature.

1. Check the network connection and settings (pages 20-22).
2. Press HOME (🏠).
3. Select the [NetCast] using ◀▶, and press ENTER (⊙).
4. Select an option using ◀▶, and press ENTER (⊙).

AccuWeather– See page 46-47

YouTube™ – See page 48-50

Picasa™ – See page 51-53

5. While enjoying on-line content from NetCast, press blue (B) colored button to go to the NetCast Home screen.



NOTE

- The content of NetCast services and service related information, including user interface, is subject to changes. Please refer to the web site of each service for most up-to-date information.
- The background image on the NetCast home indicates the weather of your favorite city in the AccuWeather feature.

Using the AccuWeather



See on-line local and global weather forecasts from AccuWeather.com.

Viewing weather information

1. On the player, select the [AccuWeather] option in the [NetCast] menu using ◀▶, and press ENTER (⊙).

The city selection menu appears on the screen.



2. Press ENTER (⊙) while [Add City to Favorite List] is selected.
3. Select a region using ▲▼, and press ENTER (⊙).



4. Select a country using ▲▼◀▶, and press ENTER (⊙).

*Note : NetCast™ feature is available with BD678N series only.

5. Select a city using ▲▼ ◀▶, and press ENTER (⊙).
6. Use ▲▼ ◀▶ to select [Home] and press ENTER (⊙) to display weather information of the selected city.



Press red (R) colored button to toggle display between Fahrenheit or Celsius thermometer.

7. Use ◀▶ to select previous or next city, and press ENTER (⊙) to display the weather information.

This step works only when you add more than 1 cities to the [Favorite city List].

NOTE

- The weather information is not always correct.
- The weather information may be displayed in English, if your own language is not available on the AccuWeather service.

Adding more cities

1. Use ◀▶ to select [Favorite City List] on the AccuWeather menu, and press ENTER (⊙).



2. Press ENTER (⊙) while [Add City to Favorite City List] is selected.
3. Select a region, country and city using ▲▼ ◀▶ and ENTER (⊙).
4. Repeats step 2-3 to add up to 5 cities. Select the [X] symbol and press ENTER (⊙) to delete the stored favorite city.
5. Use ▲▼ to select a city from the [Favorite City List], and press ENTER (⊙) to display the weather information.

*Note : NetCast™ feature is available with BD678N series only.

Playing YouTube™ videos



You can browse, search and watch YouTube™ videos over the internet to your TV via your LG Blu-ray disc player.

Watch YouTube™ videos on your TV

1. On the player, select the [YouTube™] option in the [NetCast] menu using ◀▶, and press ENTER (⊙).
2. Press ▲ to select the option menu bar.
3. Use ◀▶ to select an option and press ENTER (⊙) to search videos.
4. Use ◀▶ to select a video and press ENTER (⊙) or ▶ (play) to play the video.

Button	Operation
▶ or ENTER	Starts playback the video with content detail.
INFO/ DISPLAY	Toggle between playback in full screen and playback screen with content detail.
	To pause a video while it is playing. To resume playing a paused video, press ▶ again.
■	Stops the video and displays related videos list.
◀◀/▶▶	Skip the playback forward or backward .

About the YouTube™ menu

There are various options on the YouTube™ menu. Use ▲▼◀▶ to select an option and press ENTER (⊙) to select the options as described below.

Featured – The featured videos list will be displayed.

Recent Videos – The most recently updated videos list will be displayed.

Most Viewed – The most viewed videos list will be displayed. The period option appears at the bottom of the screen.

Top Rated – The best rated videos list from YouTube™ server will be displayed. The period option appears at the bottom of the screen.

Search – The virtual keyboard will be displayed. See “Searching videos” on **page 50** for more detail.

History – The videos list that you previously played on this unit will be displayed. Maximum of 25 videos can be stored.

Favorites – This option will be appeared only when the unit is in sign-in status. Displays the videos list that is arranged in the YouTube™ server with your account. Some videos may not appear on the [Favorites] list, even if the videos are arranged in the server.

Sign in (Sign Out) – Displays the virtual keyboard to sign in or returns to the sign-out status. See “Sign in with your YouTube™ account” on **page 50** for more details.

Local site – Choose which country's videos you would like to view. The countries listed on the [Local Site] menu may diferent with those listed on the YouTube™ web site.

*Note : NetCast™ feature is available with BD678N series only.

NOTE

- The YouTube™ menu can display 5 videos in the videos list. Press green (G) or yellow (Y) buttons to display previous/next 5 videos.
- If you select the [Most Viewed] or [Top Rated] option in the YouTube™ menu, the period options appear at the bottom of the screen. Use **▲▼◀▶** to select a period option and press ENTER (⊙) to display the videos list within the selected period.
- The videos list searched from the player may differ with the list searched from a web browser on PC.
- The playback of YouTube™ videos may be paused, stopped or buffering occurring often depending on your broadband speed. We recommend a minimum connection speed of 1.5 Mbps. For the best playback condition, a connection speed of 4.0 Mbps is required. Sometimes your broadband speed varies based on your ISP's network conditions. Contact your ISP if you have problems maintaining a fast connection that is reliable, or if you want to increase your connection speed. Many ISPs offer a variety of broadband speed options.

Using the virtual keyboard

On the virtual keyboard, there are two input mode for the entering a character. Press the yellow (Y) colored button to toggle display between keyboard mode and keypad mode.

Keyboard Mode

Use **▲▼◀▶** to select a letter on the screen, and press ENTER (⊙) to confirm your selection.



[Cancel] – Returns to the previous screen.

[Space] – Inserts a space at the cursor position.

[Backspace] – Deletes the previous character at the cursor position.

[ABC / abc / #+==&] – Changes the virtual keyboard settings to capital letters, small letters or symbols.

Press CLEAR to clear all entered characters.

To enter a letter with an accent mark:

1. Select a letter using **▲▼◀▶** on the virtual key board.
2. Press INFO/DISPLAY (Ⓜ) to display the extended character set.
3. Use **◀▶** to select a character then press ENTER (⊙).

Available languages to enter on the keyboard mode are as follows: English, Spanish, Italian, French, German, Dutch, Portuguese, Swedish, Polish and Czech.

Keypad Mode

This mode allows you to enter letters by pressing the buttons on the remote control. Press the buttons with the required letter once, twice, three or four times until the letter is displayed.



*Note : NetCast™ feature is available with BD678N series only.

Button	Operation
CLEAR	Deletes the previous character at the cursor position.
REPEAT	Inserts a space at the cursor position.
◀▶/▶▶	Changes the character set of the remote control (#+==&, 123, ABC or abc)



NOTE

The keypad mode is available only in the [YouTube™] and [Picasa™ Web Albums] features.

Searching videos

You can search for videos by entering search words of up to 128 characters.

1. Use ◀▶ to select [Search] option from the menu and press ENTER (⊙) to display the virtual keyboard.

Refer to “Using the virtual keyboard” on **page 49** for using virtual keyboard.



When you entering a character, maximum of 5 suggestion words will be displayed.

2. When you finish entering the search words, select [OK] and press ENTER (⊙) to display the related video list.

Sign in with your YouTube™ account

To watch videos from your [Favorites] video list on the YouTube™ server with your account, you need to sign in with your YouTube™ account.

1. Use ◀▶ to select [Sign In] option from the menu and press ENTER (⊙) to display the virtual keyboard.

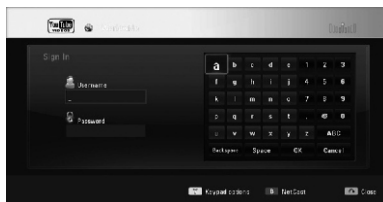

2. Use ▲▼ ◀▶ to select a character then press ENTER (⊙) to confirm your selection on the virtual keyboard.

Refer to “Using the virtual keyboard” on **page 49** for using virtual keyboard.

3. When you finish entering the user name and the password, select [OK] and press ENTER (⊙) to sign in.
4. If you want to sign out, select the [Sign Out] from the YouTube™ menu and press ENTER (⊙).

This unit can automatically store up to 5 user names which were previously signed-in. The user name list appears when you select the [Sign In] option.

Select a stored user name on the list and press ENTER (⊙) to display the keyboard menu with the selected user name is entered. You will then only need to enter the password to sign in.



Select the [X] symbol and press ENTER (⊙) to delete the stored user name.

*Note : NetCast™ feature is available with BD678N series only.

Viewing Picasa™ Web Albums



Enjoy photo albums from friends and family on the Picasa™ on-line service.

View Picasa™ Web Albums on your TV

1. On the player, select the [Picasa™ Web Albums] option in the [NetCast] menu using ◀▶, and press ENTER (⊙).
Featured photos are appeared on the screen.
2. Use ▲▼▶◀ to select a photo and press ENTER (⊙) to view the photo in full screen.

Button	Operation
▶	Starts a slide show.
INFO/DISPLAY	Displays the photo option menu.
	Pauses a slide show. To resume slide show, press ▶ again.
■	Stops the slide show and return to the Picasa™ menu.
◀▶	Moves to the next or previous photo.

Options while viewing a photo

You can use various options during viewing a photo in full screen.

1. While viewing a photo in full screen, press INFO/DISPLAY (□) to display the option menu.
2. Select an option using ▲▼.

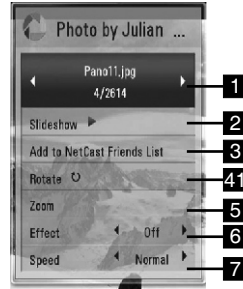

- 1 **Current photo/Total number of photos** – Use ◀▶ to view previous/next photo.
- 2 **Slide Show** – Press ENTER (⊙) to start or pause slide show.
- 3 **Add to Friends List**– Add the current photo owner to my friend list.
- 4 **Rotate** – Press ENTER (⊙) to rotate the photo clockwise.
- 5 **Zoom** – Press ENTER (⊙) to display the [Zoom] menu.
- 6 **Effect** – Use ◀▶ to select a transition effect between photos in a slide show.
- 7 **Speed** – Use ◀▶ to select a delaying speed between photos in a slide show.

3. Press RETURN (↵) to exit the option menu.

*Note : NetCast™ feature is available with BD678N series only.

About the Picasa™ menu

There are various options on the Picasa™ menu. Use ▲▼◀▶ to select an menu option and press ENTER (⊙) to select the options as described below.

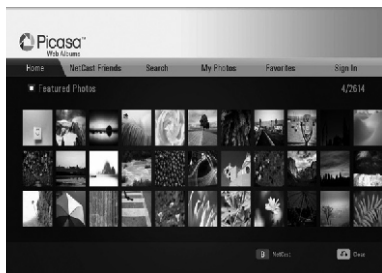

Home – The featured photo list will be displayed.

NetCast Friends – List of your friends will be displayed.

Search – Enter a search word to find related photos. The virtual keyboard will be displayed (page 49).

My Photos – Displays the photos organized in my Picasa™ Web Album. This option is available only when the unit is in sign-in status.

Favorites – Displays up to 50 favorite web albums that are arranged in the Picasa™ web server with your account. This option is available only when the unit is in sign-in status.

Sign in (Sign Out) – Displays the virtual keyboard to sign in or returns to the sign-out status (page 50).

! NOTE

Photos displayed in [My Photos] and [Favorites] may differ with the photos from a web browser on PC.

Adding friends

If you add your friends on the [NetCast Friends] menu, you can see the photos of your friend's public photos directly.

1. Select the [NetCast Friends] on the Picasa™ menu using ▲▼◀▶, and press ENTER (⊙).

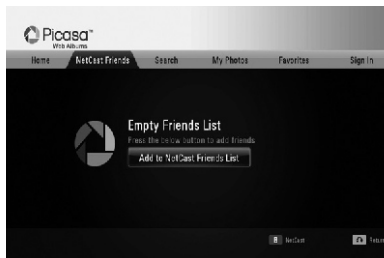

2. Press ENTER (⊙) to display the virtual keyboard.
3. Enter a name using the virtual keyboard. Refer to "Using the virtual keyboard" on page 49 for using virtual keyboard.
4. Select [OK] using ▲▼◀▶, and press ENTER (⊙) to display the web album of your friend.

! NOTE

- If you want to delete your friend from the list, press green (G) colored button while the web album is selected.
- If you want to add more friends, press red (R) colored button on the list.
- You can add more web albums of your friends up to 50.

*Note : NetCast™ feature is available with BD678N series only.

Searching photos

You can enter a search word to find related photos.

1. Select the [Search] on the Picasa™ menu using **▲▼ ◀▶**, and press ENTER (⊙).
2. Enter a search word using the virtual keyboard.
Refer to “Using the virtual keyboard” on **page 49** for using virtual keyboard.
3. Select [OK] using **▲▼ ◀▶**, and press ENTER (⊙) to display the search result.

NOTE
The search result from the player may differ with the result searched from a web browser on PC.

Signing in with your account

To display photos in your web album on the screen, you need to sign in with your Picasa™ account.

1. Select the [Sign In] on the Picasa™ menu using **▲▼ ◀▶**, and press ENTER (⊙).



2. Enter your user name using the virtual keyboard, and press ENTER (⊙) while [OK] is selected.
Refer to “Using the virtual keyboard” on **page 49** for using virtual keyboard.

3. Enter the password using the virtual keyboard, and press ENTER (⊙) while [OK] is selected.

Your web album is appeared on the screen.

4. If you want to sign out, select the [Sign Out] from the Picasa™ menu and press ENTER (⊙).

This unit can automatically store up to 5 user names which were previously signed-in. The user name list appears when you select the [Sign In] option.

Select a stored user name on the list and press ENTER (⊙) to display the virtual keyboard with the selected user name is entered. You will then only need to enter the password to sign in.

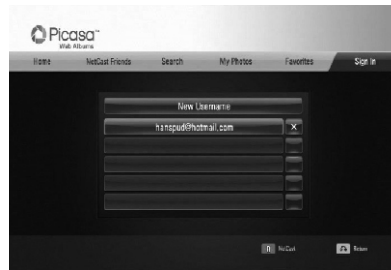

Select the [X] symbol and press ENTER (⊙) to delete the stored user name.

*Note : NetCast™ feature is available with BD678N series only.

5 Maintenance

Notes on Discs

Handling Discs

Do not touch the playback side of the disc. Hold the disc by the edges so that fingerprints do not get on the surface. Never stick paper or tape on the disc.

Storing Discs

After playing, store the disc in its case. Do not expose the disc to direct sunlight or sources of heat and never leave it in a parked car exposed to direct sunlight.

Cleaning Discs

Fingerprints and dust on the disc can cause poor picture quality and sound distortion. Before playing, clean the disc with a clean cloth. Wipe the disc from the center to out.

Do not use strong solvents such as alcohol, benzene, thinner, commercially available cleaners, or anti-static spray intended for older vinyl records.

Handling the Unit

When shipping the unit

Please save the original shipping carton and packing materials. If you need to ship the unit, for maximum protection, re-pack the unit as it was originally packed at the factory.

Keeping the exterior surfaces clean

- Do not use volatile liquids such as insecticide spray near the unit.
- Wiping with strong pressure may damage the surface.
- Do not leave rubber or plastic products in contact with the unit for a long period of time.

Cleaning the unit

To clean the player, use a soft, dry cloth. If the surfaces are extremely dirty, use a soft cloth lightly moistened with a mild detergent solution. Do not use strong solvents such as alcohol, benzene, or thinner, as these might damage the surface of the unit.

Maintaining the Unit

The unit is a high-tech, precision device. If the optical pick-up lens and disc drive parts are dirty or worn, the picture quality could be diminished. For details, please contact your nearest authorized service center.

6

Troubleshooting

General

Symptom	Cause & Solution
The Power does not turned on.	<ul style="list-style-type: none"> Plug the power cord into the wall outlet securely.
The unit does not start playback.	<ul style="list-style-type: none"> Insert a playable disc. (Check the disc type, color system, and regional code.) Place the disc with the playback side down. Place the disc on the disc tray correctly inside the guide. Clean the disc. Cancel the Rating function or change the rating level.
The angle cannot be changed.	<ul style="list-style-type: none"> Multi-angles are not recorded on the BD/DVD Video being played.
Cannot play movie, music or photo files.	<ul style="list-style-type: none"> The files are not recorded in a format that the unit can play. The unit does not support the codec of the movie file.
The remote control does not work properly.	<ul style="list-style-type: none"> The remote control is not pointed at the remote sensor of the unit. The remote control is too far from the unit. There is an obstacle in the path of the remote control and the unit. The battery in the remote control is exhausted.
The unit is plugged in, but the power will not turn on or of.	<p>You can reset the unit as follows.</p> <ol style="list-style-type: none"> Press and hold the  (POWER) button for at least five seconds. This will force the unit to power of then turn the unit back on. Unplug the power cord, wait at least five seconds, and then plug it in again.
The unit is not operating normally.	

Picture

Symptom	Cause & Solution
There is no picture.	<ul style="list-style-type: none"> • Select the appropriate video input mode on the TV so the picture from the unit appears on the TV screen. • Connect the video connection securely. • Check the [HDMI Color Setting] in the [Setup] menu is set to the appropriate item that conforms to your video connection. • Your TV may not support the resolution you have set on the player. Change the resolution that your TV accepts. • The player's HDMI OUT jack is connected to a DVI device that does not support copyright protection.
Picture noise appears	<ul style="list-style-type: none"> • You are playing a disc recorded in a color system that is different from your TV. • Set the resolution which your TV accepts.

Sound

Symptom	Cause & Solution
There is no sound or the sound is distorted.	<ul style="list-style-type: none"> • Connect the audio connection securely. • The input source setting on the amplifier or the connection to the amplifier is incorrect. • The unit is in scan, slow motion, or pause mode. • The sound volume is low. • Check that the connected amplifier is compatible with audio format output from the player. • The player's HDMI OUT jack is connected to a DVI device. The DVI jack does not accept audio signal. • Check the device connected to player's HDMI OUT jack is compatible with audio format output from the player.

Network

Symptom	Cause & Solution
BD-LIVE feature does not work.	<ul style="list-style-type: none">• The connected USB storage may not have enough space. Connect the USB storage with at least 1GB free space.• Ensure that the unit is correctly connected to the local area network and can access the internet (see pages 20-22).• Your broadband speed may not fast enough to use the BD-LIVE features. Contact your Internet Service Provider (ISP) and increase the broadband speed is recommended.• The [BD-LIVE connection] option in the [Setup] menu is set to [Prohibited]. Set the option to [Permitted].

Customer Support

You can update the Player using the latest software to enhance the products operation and/or add new features. To obtain the latest software for this player (if updates have been made), please visit <http://lgservice.com> or contact LG Electronics customer care center.

7

Appendix

Controlling a TV with the Supplied Remote Control

You can control your TV using the buttons below.



By pressing	You can
(TV POWER)	Turn the TV on or of.
AV/INPUT	Switch the TV's input source between the TV and other input sources.
PR/CH +/-	Scan up or down through memorized channels.
VOL +/-	Adjust the volume of the TV
TV MUTE	Turn the TV's volume on or of.

NOTE

Depending on the unit being connected, you may not be able to control your TV using some of the buttons.

Setting up the remote to control your TV

You can operate your TV with the supplied remote control.

If your TV is listed in the table below, set the appropriate manufacturer code.

- While holding down (TV POWER) button, and press the manufacturer code for your TV with the numerical buttons (see the table below).

Manufacturer	Code Number
LG	1(Default), 2
Zenith	1, 3, 4
GoldStar	1, 2
Samsung	6, 7
Sony	8, 9
Hitachi	4

- Release the (TV POWER) button to complete setting.

Depending on your TV, some or all buttons may not function on the TV, even after entering the correct manufacturer code. When you replace the batteries of the remote, the code number you have set may be reset to the default setting. Set the appropriate code number again.

Network Software Update

Network update notification

From time to time, performance improvements and/or additional features or services may be made available to units that are connected to a broadband home network. If there is new software available and the unit is connected to a broadband home network, the player will inform you about the update as follows.

Option 1:

1. The update menu will appear on the screen when you turn on the player.
2. Use ◀▶ to select a desired option and then press ENTER (⊙).

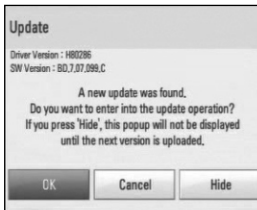

[OK]

Starts the software update.

[Cancel]

Exits the update menu and displays it next booting.

[Hide]

Exits the update menu and it does not appear until next software is uploaded in the update server.

Option 2:

If the software update is available from the update server, the "Update" icon appears at the bottom of the Home menu. Press blue (B) colored button to start the update procedure.

Software Update

You can update the player using the latest software to enhance the products operation and/or add new features. You can update the software by connecting the unit directly to the software update server.



CAUTION

- Before updating the software in your player, remove any disc and USB Device from the player.
- Before updating the software in your player, turn the player off and then turn it back on.
- **During the software update procedure, do not turn off the player or disconnect AC power, or do not press any button.**
- If you cancel the update, turn off the power and turn it on for stable performance.
- This unit cannot be updated to previous software version.

1. Check the network connection and settings (page 20-22).
2. Select [Software] option in the [Setup] menu then press ENTER (⊙).

3. Select [Update] option, and press ENTER (Ⓞ).

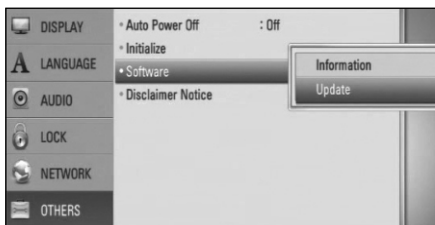

The player will check for the newest update.

NOTE

- Pressing ENTER (Ⓞ) while checking for the update will end the process.
 - If there is no update available, the Message, "No update is found" appears. Press ENTER (Ⓞ) to return to the [Home Menu].
4. If newer version exists, the message "A new update was found. Do you want to download it?" appears.

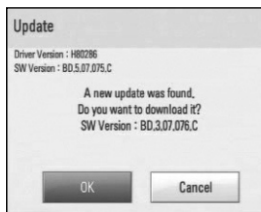

5. Select [OK] to download the update. (Selecting [Cancel] will end the update.)
6. The player starts downloading the newest update from the server. (Downloading will take several minutes depending on your home network condition)
7. When downloading is completed, the message, "Download is complete. Do you want to update?" appears.

8. Select [OK] to start updating. (Selecting [Cancel] will end the update and downloaded file will not be re-usable. To update software the next time, the software update procedure has to be started from the beginning again.)

CAUTION

Do not turn off the power during the software update.

NOTE

If the software includes the driver update, disc tray may open during the process.

9. When update is completed, the message, "Update is complete" will appear, and then power will turn off automatically after 5 seconds.
10. Turn the power back on. The system now operates with the new version.

NOTE

The Software Update function may not work properly depending on your Internet environment. In this case, you can obtain the latest software from the authorized LG Electronics Service Center then update your player. Refer to "Customer Support" on page 49.

Area Code List

Choose an area code from this list.

Area	Code	Area	Code	Area	Code	Area	Code
Afghanistan	AF	Fiji	FJ	Monaco	MC	Singapore	SG
Argentina	AR	Finland	FI	Mongolia	MN	Slovak Republic	SK
Australia	AU	France	FR	Morocco	MA	Slovenia	SI
Austria	AT	Germany	DE	Nepal	NP	South Africa	ZA
Belgium	BE	Great Britain	GB	Netherlands	NL	South Korea	KR
Bhutan	BT	Greece	GR	Antilles	AN	Spain	ES
Bolivia	BO	Greenland	GL	New Zealand	NZ	Sri Lanka	LK
Brazil	BR	Hong Kong	HK	Nigeria	NG	Sweden	SE
Cambodia	KH	Hungary	HU	Norway	NO	Switzerland	CH
Canada	CA	India	IN	Oman	OM	Taiwan	TW
Chile	CL	Indonesia	ID	Pakistan	PK	Thailand	TH
China	CN	Israel	IL	Panama	PA	Turkey	TR
Colombia	CO	Italy	IT	Paraguay	PY	Uganda	UG
Congo	CG	Jamaica	JM	Philippines	PH	Ukraine	UA
Costa Rica	CR	Japan	JP	Poland	PL	United States	US
Croatia	HR	Kenya	KE	Portugal	PT	Uruguay	UY
Czech Republic	CZ	Kuwait	KW	Romania	RO	Uzbekistan	UZ
Denmark	DK	Libya	LY	Russian		Vietnam	VN
Ecuador	EC	Luxembourg	LU	Federation	RU	Zimbabwe	ZW
Egypt	EG	Malaysia	MY	Saudi Arabia	SA		
El Salvador	SV	Maldives	MV	Senegal	SN		
Ethiopia	ET	Mexico	MX				

Language code List

Use this list to input your desired language for the following initial settings: [Disc Audio], [Disc Subtitle] and [Disc Menu].

Language	Code	Language	Code	Language	Code	Language	Code
Afar	6565	French	7082	Lithuanian	7684	Sindhi	8368
Afrikaans	6570	Frisian	7089	Macedonian	7775	Singhalese	8373
Albanian	8381	Galician	7176	Malagasy	7771	Slovak	8375
Ameharic	6577	Georgian	7565	Malay	7783	Slovenian	8376
Arabic	6582	German	6869	Malayalam	7776	Spanish	6983
Armenian	7289	Greek	6976	Maori	7773	Sudanese	8385
Assamese	6583	Greenlandic	7576	Marathi	7782	Swahili	8387
Aymara	6588	Guarani	7178	Moldavian	7779	Swedish	8386
Azerbaijani	6590	Gujarati	7185	Mongolian	7778	Tagalog	8476
Bashkir	6665	Hausa	7265	Nauru	7865	Language	Code
Basque	6985	Hebrew	7387	Nepali	7869	Tajik	8471
Bengali; Bangla	6678	Hindi	7273	Norwegian	7879	Tamil	8465
Bhutani	6890	Hungarian	7285	Oriya	7982	Telugu	8469
Bihari	6672	Icelandic	7383	Panjabi	8065	Thai	8472
Breton	6682	Indonesian	7378	Pashto, Pushto	8083	Tonga	8479
Bulgarian	6671	Interlingua	7365	Persian	7065	Turkish	8482
Burmese	7789	Irish	7165	Polish	8076	Turkmen	8475
Byelorussian	6669	Italian	7384	Portuguese	8084	Twi	8487
Chinese	9072	Japanese	7465	Quechua	8185	Ukrainian	8575
Croatian	7282	Kannada	7578	Rhaeto-Romance		Urdu	8582
Czech	6783	Kashmiri	7583		8277	Uzbek	8590
Danish	6865	Kazakh	7575	Rumanian	8279	Vietnamese	8673
Dutch	7876	Kirghiz	7589	Russian	8285	Volapük	8679
English	6978	Korean	7579	Samoan	8377	Welsh	6789
Esperanto	6979	Kurdish	7585	Sanskrit	8365	Wolof	8779
Estonian	6984	Laothian	7679	Scots Gaelic	7168	Xhosa	8872
Faroese	7079	Latin	7665	Serbian	8382	Yiddish	7473
Fiji	7074	Latvian, Lettish	7686	Serbo-Croatian	8372	Yoruba	8979
Finnish	7073	Lingala	7678	Shona	8378	Zulu	9085

Trademarks and Licenses



"Blu-ray Disc" is a trademark.



"BD-LIVE" logo is a trademark of Blu-ray Disc Association.

"BONUSVIEW" is trademark of Blu-ray Disc Association.



Java and all Java-based trademarks and logos are trademarks or registered trademarks of Sun Microsystems, Inc. in the United States and other countries.



Manufactured under license from Dolby Laboratories. Dolby and the double-D symbol are trademarks of Dolby Laboratories.



HDMI, the HDMI logo and High-Definition Multimedia Interface are trademarks or registered trademarks of HDMI licensing LLC.



"DVD Logo" is a trademark of DVD Format/Logo Licensing Corporation.



This product is licensed under the AVC patent portfolio license and VC-1 patent portfolio license for the personal and non-commercial use of a consumer to (i) encode video in compliance with the AVC Standard and VC-1 Standard ("AVC/VC-1 Video") and/or (ii) decode AVC/VC-1 Video that was encoded by a consumer engaged in a personal and non-commercial activity and/or was obtained from a video provider licensed to provide AVC/VC-1 Video. No license is granted or shall be implied for any other use. Additional information may be obtained from MPEG LA, LLC. See <http://www.mpegla.com>.

"AVCHD" and the "AVCHD" logo are trademarks of Panasonic Corporation and Sony Corporation.



Manufactured under license under U.S. Patent #'s: 5,451,942; 5,956,674; 5,974,380; 5,978,762; 6,226,616; 6,487,535; 7,212,872; 7,333,929; 7,392,195; 7,272,567 & other U.S. and worldwide patents issued & pending. DTS is a registered trademark and the DTS logos, Symbol, DTS-HD and DTS-HD Master Audio are trademarks of DTS, Inc. © 1996-2008 DTS, Inc. All Rights Reserved.

"x.v.Color" is a trademark of Sony Corporation.



DivX is a registered trademark of DivX, Inc., and is used under license.

"x.v.Colour" is a trademark of Sony Corporation.

Audio Output Specifications

Jack/Setting Source	Analog 2CH Output	Digital Output (SPDIF) (DIGITAL AUDIO OUT) *4		
		PCM Stereo	DTS Re-encode*3 *5	Primary Pass-Thru
Dolby Digital	PCM 2ch	PCM 2ch	DTS	Dolby Digital
Dolby Digital Plus	PCM 2ch	PCM 2ch	DTS	Dolby Digital
Dolby TrueHD	PCM 2ch	PCM 2ch	DTS	Dolby Digital
DTS	PCM 2ch	PCM 2ch	DTS	DTS
DTS-HD	PCM 2ch	PCM 2ch	DTS	DTS
Linear PCM 2ch	PCM 2ch	PCM 2ch	DTS	PCM 2ch
Linear PCM 5.1ch	PCM 2ch	PCM 2ch	DTS	PCM 2ch
Linear PCM 7.1ch	PCM 2ch	PCM 2ch	DTS	PCM 2ch

Jack/Setting Source	HDMI OUT			
	PCM Stereo	PCM Multi-Ch *3	DTS Re-encode *3 *5	Primary Pass-Thru *1 *2 *3
Dolby Digital	PCM 2ch	PCM 2ch	DTS	Dolby Digital
Dolby Digital Plus	PCM 2ch	PCM 2ch	DTS	Dolby Digital Plus
Dolby TrueHD	PCM 2ch	PCM 2ch	DTS	Dolby TrueHD
DTS	PCM 2ch	PCM 5.1ch	DTS	DTS
DTS-HD	PCM 2ch	PCM 7.1ch	DTS	DTS-HD
Linear PCM 2ch	PCM 2ch	PCM 2ch	DTS	Linear PCM 2ch
Linear PCM 5.1ch	PCM 2ch	PCM 5.1ch	DTS	Linear PCM 5.1ch
Linear PCM 7.1ch	PCM 2ch	PCM 7.1ch	DTS	Linear PCM 7.1ch

*1 The secondary and interactive audio may not be included in the output bitstream if [Digital Output (SPDIF)] or [HDMI] option is set to [Primary Pass-Thru]. (Except LPCM Codec : the output always include interactive and secondary audio.)

*2 This player automatically selects the HDMI audio according to the decoding capability of the connected HDMI device even though [HDMI] option is set to [Primary Pass-Thru].

*3 The [PCM Multi-CH]/[Primary Pass-Thru] setting of the [HDMI] option and [DTS re-encode] setting of the [Digital Output (SPDIF)] option cannot be set together. If you set them together, the [HDMI] or [Digital Output (SPDIF)] option is set to [PCM Stereo] automatically.

*4 On the PCM audio output, the sampling frequency of DIGITAL AUDIO OUT is limited to 96 kHz.

- *5 If the [HDMI] or [Digital Output (SPDIF)] option is set to [DTS re-encode], the audio output is limited to 48 kHz and 5.1Ch. If the [HDMI] or [Digital Output (SPDIF)] option is set to [DTS re-encode], the DTS Re-encode audio is outputted for BD-ROM discs, and the original audio is outputted for the other discs (like [Primary Pass-Thru]).
- If [HDMI] option is set to [PCM Multi-CH] and [Digital Output (SPDIF)] option is set to [Primary Pass-Thru] while playback Dolby Digital Plus or TrueHD audio, DIGITAL AUDIO OUT is limited to "PCM 2ch".
 - If the HDMI connection is version 1.3 and Dolby Digital Plus/Dolby TrueHD is outputted from HDMI OUT jack, DIGITAL AUDIO OUT jack is limited to "PCM 2ch" (When the HDMI and DIGITAL AUDIO OUT are connected simultaneously).
 - The audio is outputted as PCM 48 kHz/16 bit for MP3/WMA file and PCM 44.1kHz/16 bit for Audio CD while playback.
 - The Dolby TrueHD audio recorded on some Blu-ray discs consists of Dolby Digital and TrueHD audio. Dolby Digital audio is output through DIGITAL AUDIO OUT jacks and "DD" displays on the screen if TrueHD audio is not output (for example, when [HDMI] is set to [PCM Stereo] and [Digital Output (SPDIF)] is set to [Primary Pass-Thru]).
 - You must select a digital audio output and a maximum sampling frequency that your Amplifier (or AV receiver) accepts using [Digital Output (SPDIF)], [HDMI] and [Sampling Freq.] options on the [Setup] menu (see page 27).
 - With digital audio connection (DIGITAL AUDIO OUT or HDMI), Disc Menu button sounds of BD-ROM may not be heard if the [Digital Output (SPDIF)] or [HDMI] option is set to [Primary Pass-Thru].
 - If the audio format of the digital output does not match the capabilities of your receiver, the receiver will produce a strong, distorted sound or no sound at all.
- Multi-channel Digital Surround Sound via digital connection can only be obtained if your receiver is equipped with a Digital Multi-channel decoder.

Video Output Resolution

When the non-copy protected media is playing back

Resolution \ Video Out	HDMI OUT	COMPONENT VIDEO OUT	
		HDMI connected	HDMI disconnected
576i	576p	576i	
576p	576p	576p	
720p	720p	720p	
1080i	1080i	1080i	
1080p/24 Hz	1080p / 24 Hz	576i	1080i
1080p / 50 Hz	1080p / 50 Hz	576i	1080i

When the copy protected media is playing back

Resolution \ Video Out	HDMI OUT	COMPONENT VIDEO OUT	
		HDMI connected	HDMI disconnected
576i	576p	576i	
576p	576p	576p	
720p	720p	576i	576p
1080i	1080i	576i	576p
1080p/24 Hz	1080p / 24 Hz	576i	576p
1080p / 50 Hz	1080p / 50 Hz	576i	576p

HDMI OUT connection

- If you select a resolution manually and then connect the HDMI jack to TV and your TV does not accept it, the resolution setting is set to [Auto].
- If you select a resolution that your TV does not accept, the warning message will appear. After resolution change, if you cannot see the screen, please wait 20 seconds and the resolution will automatically revert back to the previous resolution.

- The 1080p video output frame rate may be automatically set to either 24 Hz or 50 Hz depending both on the capability and preference of the connected TV and based on the native video frame rate of the content on the BD-ROM disc.

COMPONENT VIDEO OUT Connection

BD, DVD, Netflix or CinemaNow video stream could prevent up-scaling on analog output.

VIDEO OUT connection

The resolution of the VIDEO OUT jack is always 576i outputted at resolution.

When you set the HDMI Resolution, over 720p is not outputted to Composit Video.

Specifications

General

Power requirements:
AC200-240~50/60Hz

Power consumption:
14 W

Dimensions (W x H x D):
Approx. 430 x 45 x 190 mm without foot

Net Weight (Approx.):
1.6 kg

Operating temperature:
5 °C to 35 °C (41 °F to 95 °F)

Operating humidity:
5 % to 90 %

Outputs

VIDEO OUT:
1.0V (p-p), 75 Ω, sync negative, RCA jack x 1

COMPONENT VIDEO OUT:
(Y) 1.0V (p-p), 75 Ω, sync negative,
RCA jack x 1,
(Pb)/(Pr) 0.7V (p-p), 75 Ω, RCA jack x 2

HDMI OUT (video/audio):
19 pin (HDMI standard, Type A, Version 1.3)

ANALOG AUDIO OUT:
2.0 Vrms (1 kHz, 0 dB), 600 Ω, RCA jack (L, R) x 1

DIGITAL OUT (COAXIAL):
0.5V (p-p), 75 Ω, RCA jack x 1

System

Laser:
Semiconductor laser

wavelength:
405 nm / 650 nm

Signal system:
Standard NTSC/PAL color TV system

Frequency response:
20 Hz to 20 kHz
(48 kHz, 96 kHz, 192 kHz sampling)

Signal-to-noise ratio:
More than 90 dB
(ANALOG OUT connectors only)

Harmonic distortion:
Less than 0.02%

Dynamic range:
More than 95 dB

LAN port:
Ethernet jack x 1, 10BASE-T/100BASE-TX

Bus Power Supply (USB):
DC 5V \pm 500 mA

- Design and specifications are subject to change without notice.

Important Information Relating to Network Services

PLEASE READ CAREFULLY. USE OF THE NETWORK SERVICES IS SUBJECT TO THE FOLLOWING TERMS AND CONDITIONS.

Use of the Network Services requires an Internet connection which is sold separately and for which you are solely responsible. The Network Services may be limited or restricted depending upon the quality, capabilities and technical limitations of your Internet service.

The Network Services belong to third parties and may be protected by copyright, patent, trademark and/or other intellectual property laws. The Network Services are provided solely for your personal and noncommercial use. Unless expressly authorized by the respective content owner or service provider, you shall not modify, copy, republish, upload, post, transmit, translate, sell, create derivative works, exploit, or distribute in any manner or medium any content or services accessible through this product.

LG IS NOT RESPONSIBLE FOR YOUR USE OF THE NETWORK SERVICES. THE NETWORK SERVICES ARE PROVIDED "AS IS" TO THE FULLEST EXTENT PERMISSIBLE BY LAW, LG MAKES NO REPRESENTATIONS OR WARRANTIES OF ANY KIND WHATSOEVER (i) FOR THE ACCURACY, VALIDITY, TIMELINESS, LEGALITY, OR COMPLETENESS OF ANY NETWORK SERVICE MADE AVAILABLE THROUGH THIS PRODUCT; OR (ii) THAT THE NETWORK SERVICES ARE FREE OF VIRUSES OR OTHER COMPONENTS THAT MAY INFECT, HARM, OR CAUSE DAMAGE TO THIS PRODUCT, YOUR COMPUTER, TELEVISION, OTHER EQUIPMENT, OR ANY OTHER PROPERTY. LG EXPRESSLY DISCLAIMS ANY IMPLIED WARRANTIES, INCLUDING BUT NOT LIMITED TO, WARRANTIES OF MERCHANTABILITY OR FITNESS FOR A PARTICULAR PURPOSE.

UNDER NO CIRCUMSTANCES AND UNDER NO LEGAL THEORY, WHETHER IN CONTRACT, TORT, STRICT LIABILITY OR OTHERWISE, SHALL LG BE LIABLE TO YOU OR ANY THIRD PARTY FOR ANY DIRECT, INDIRECT, INCIDENTAL, SPECIAL, STATUTORY, CONSEQUENTIAL OR OTHER DAMAGES OR ATTORNEY FEES OR EXPENSES RELATING TO OR ARISING OUT OF THE NETWORK SERVICES EVEN IF ADVISED OF THE POSSIBILITY OF SUCH DAMAGES OR IF SUCH DAMAGES COULD HAVE BEEN REASONABLY FORESEEN.

The Network Services may be terminated or interrupted at any time, and LG makes no representation or warranty that any Network Service will remain available for any period of time. Use of the Network Services may be subject to additional terms and conditions of the respective third party service provider. The Network Services are transmitted by third parties by means of networks and transmission facilities over which LG has no control. LG EXPRESSLY DISCLAIMS ANY RESPONSIBILITY OR LIABILITY FOR ANY INTERRUPTION OR SUSPENSION OF ANY NETWORK SERVICE.

LG shall be neither responsible nor liable for customer service related to the Network Services. Any question or request should be made directly to the respective Network Service providers.

"Network Service(s)" means the third party services accessible through this product including but not limited to all data, software, links, messages, video and other content found thereon or used in connection therewith.

"LG" means LG Electronics, Inc. its parent company and all of their respective subsidiaries, affiliates and related companies worldwide.

Open source software notice

The following GPL executables and LGPL libraries used in this product are subject to the GPL2.0/LGPL2.1 License Agreements:

GPL EXECUTABLES: Linux kernel 2.6, bash, busybox, cramfs, dhcpcd, e2fsprogs, fdisk, mkdosfs, mtd-utils, net-tools, procps, samba-3.0.25b, sysutils, tcpdump, tftpd, tinylogin, unzip, utelnetd

LGPL LIBRARIES: uClibc, DirectFB, blowfish, cairo, fmpg, iconv, libusb, mpg123

gSOAP Public License 1.3 LIBRARY: gsoap

LG Electronics offers to provide source code to you on CD-ROM for a charge covering the cost of performing such distribution, such as the cost of media, shipping and handling upon e-mail request to LG Electronics at: opensource@lge.com

This offer is valid for a period of three(3) years from the date of the distribution of this product by LG Electronics.

You can obtain a copy of the GPL, LGPL licenses from <http://www.gnu.org/licenses/old-licenses/gpl-2.0.html> and <http://www.gnu.org/licenses/old-licenses/lgpl-2.1.html>.

Also you can obtain a copy of gSOAP public license from <http://www.cs.fsu.edu/~engelen/license.html>.

This software is based in part on the work of the Independent JPEG Group copyright © 1991 - 1998, Thomas G. Lane.

This product includes

- boost C++: copyright © Beman Dawes 1999-2003
- c-ares : copyright © 1998 by the Massachusetts Institute of Technology
- curl: copyright © 1996 - 2008, Daniel Stenberg
- expat: copyright © 2006 expat maintainers
- freetype: copyright © 2003 The FreeType Project (www.freetype.org).
- jpeg: This software is based in part on the work of the Independent JPEG Group copyright © 1991 – 1998, Thomas G. Lane.
- mng: copyright © 2000-2007 Gerard Juyn, Glenn Randers-Pehrson
- ntp : copyright © David L. Mills 1992-2006

- **OpenSSL:**
 - cryptographic software written by Eric Young (eay@cryptsoft.com).
 - software written by Tim Hudson (tjh@cryptsoft.com).
 - software developed by the OpenSSL Project for use in the OpenSSL Toolkit. (<http://www.openssl.org>)
- png: copyright © 2004 Glenn Randers-Pehrson
- portmap : copyright © 1990 The Regents of the University of California
- ptmalloc : copyright © 2001-2006 Wolfram Gloger
- UnitTest++ : copyright © 2006 Noel Llopis and Charles Nicholson
- UPnP SDK : copyright © 2000-2003 Intel Corporation
- strace :
 - copyright © 1991, 1992 Paul Kranenburg
 - copyright © 1993 Branko Lankester
 - copyright © 1993 Ulrich Pegelow
 - copyright © 1995, 1996 Michael Elizabeth Chastain
 - copyright © 1993, 1994, 1995, 1996 Rick Sladkey
 - copyright © 1999,2000 Wichert Akkerman
- xml2 : copyright © 1998-2003 Daniel Veillard
- XML-RPC For C/C++:
 - copyright © 2001 by First Peer, Inc. All rights reserved.
 - copyright © 2001 by Eric Kidd. All rights reserved.
- zlib: copyright © 1995-2002 Jean-loup Gailly and Mark Adler.

All rights reserved.

Permission is hereby granted, free of charge, to any person obtaining a copy of this software and associated documentation files (the“Software”), to deal in the Software without restriction, including without limitation the rights to use, copy, modify, merge, publish, distribute, sublicense, and/or sell copies of the Software, and to permit persons to whom the Software is furnished to do so, subject to the following conditions:

THE SOFTWARE IS PROVIDED“AS IS”,WITHOUT WARRANTY OF ANY KIND, EXPRESS OR IMPLIED, INCLUDING BUT NOT LIMITED TO THE WARRANTIES OF MERCHANTABILITY, FITNESS FOR A PARTICULAR PURPOSE AND NON-INFRINGEMENT. IN NO EVENT SHALL THE AUTHORS OR COPYRIGHT HOLDERS BE LIABLE FOR ANY CLAIM, DAMAGES OR OTHER LIABILITY,WHETHER IN AN ACTION OF CONTRACT, TORT OR OTHERWISE, ARISING FROM, OUT OF OR IN CONNECTION WITH THE SOFTWARE OR THE USE OR OTHER DEALINGS IN THE SOFTWARE.



 **LG** **24 x 7 CALL CENTER**

 **1800-180-9999**
CALL (Toll Free)

 **5757554**
SMS (Send SMS)

 www.lg.com
 serviceindia@lge.com

Free Manuals Download Website

<http://myh66.com>

<http://usermanuals.us>

<http://www.somanuals.com>

<http://www.4manuals.cc>

<http://www.manual-lib.com>

<http://www.404manual.com>

<http://www.luxmanual.com>

<http://aubethermostatmanual.com>

Golf course search by state

<http://golfingnear.com>

Email search by domain

<http://emailbydomain.com>

Auto manuals search

<http://auto.somanuals.com>

TV manuals search

<http://tv.somanuals.com>