



OWNER'S MANUAL

Blu-ray Disc™ /DVD Player

with built-in HDD & HD

Tuner

Please read this manual carefully before operating your set and retain it for future reference.

FOR THE GUARANTEE TERMS & CONDITIONS, PLEASE REFER TO INNER PAGE OF BACK COVER.

HR931M / HR932M / HR933M / HR935M / HR939M



www.lg.com

Safety Information



CAUTION: TO REDUCE THE RISK OF ELECTRIC SHOCK DO NOT REMOVE COVER (OR BACK) NO USER-SERVICEABLE PARTS INSIDE REFER SERVICING TO QUALIFIED SERVICE PERSONNEL.



This lightning flash with arrowhead symbol within an equilateral triangle is intended to alert the user to the presence of uninsulated dangerous voltage within the product's enclosure that may be of sufficient magnitude to constitute a risk of electric shock to persons.



The exclamation point within an equilateral triangle is intended to alert the user to the presence of important operating and maintenance (servicing) instructions in the literature accompanying the product.

WARNING: TO PREVENT FIRE OR ELECTRIC SHOCK HAZARD, DO NOT EXPOSE THIS PRODUCT TO RAIN OR MOISTURE.

WARNING: Do not install this equipment in a confined space such as a book case or similar unit.

CAUTION: Do not block any ventilation openings. Install in accordance with the manufacturer's instructions.

Slots and openings in the cabinet are provided for ventilation and to ensure reliable operation of the product and to protect it from over heating. The openings shall be never be blocked by placing the product on a bed, sofa, rug or other similar surface. This product shall not be placed in a built-in installation such as a bookcase or rack unless proper ventilation is provided or the manufacturer's instruction has been adhered to.



CAUTION: This product employs a Laser System. To ensure proper use of this product, please read this owner's manual carefully and retain it for future reference. Shall the unit require maintenance, contact an authorized service centre. Use of controls, adjustments or the performance of procedures other than those specified herein may result in hazardous radiation exposure. To prevent direct exposure to laser beam, do not try to open the enclosure.

CAUTION concerning the Power Cord

Most appliances recommend they be placed upon a dedicated circuit;

That is, a single outlet circuit which powers only that appliance and has no additional outlets or branch circuits. Check the specification page of this owner's manual to be certain. Do not overload wall outlets. Overloaded wall outlets, loose or damaged wall outlets, extension cords, frayed power cords, or damaged or cracked wire insulation are dangerous. Any of these conditions could result in electric shock or fire. Periodically examine the cord of your appliance, and if its appearance indicates damage or deterioration, unplug it, discontinue use of the appliance, and have the cord replaced with an exact replacement part by an authorized service centre. Protect the power cord from physical or mechanical abuse, such as being twisted, kinked, pinched, closed in a door, or walked upon. Pay particular attention to plugs, wall outlets, and the point where the cord exits the appliance. To disconnect power from the mains, pull out the mains cord plug. When installing the product, ensure that the plug is easily accessible.

This device is equipped with a portable battery or accumulator.

Safety way to remove the battery or the battery from the equipment: Remove the old battery or battery pack, follow the steps in reverse order than the assembly. To prevent contamination of the environment and bring on possible threat to human and animal health, the old battery or the battery put it in the appropriate container at designated collection points. Do not dispose of batteries or battery together with other waste. It is recommended that you use local, free reimbursement systems batteries and accumulators. The battery shall not be exposed to excessive heat such as sunshine, fire or the like.

CAUTION: The apparatus shall not be exposed to water (dripping or splashing) and no objects filled with liquids, such as vases, shall be placed on the apparatus.

Disposal of your old appliance



1. When this crossed-out wheeled bin symbol is attached to a product it means the product is covered by the European Directive 2002/96/EC.
2. All electrical and electronic products shall be disposed of separately from the municipal waste stream via designated collection facilities appointed by the government or the local authorities.
3. The correct disposal of your old appliance will help prevent potential negative consequences for the environment and human health.
4. For more detailed information about disposal of your old appliance, please contact your city office, waste disposal service or the shop where you purchased the product.

Disposal of waste batteries/accumulators



1. When this crossed-out wheeled bin symbol is attached to batteries/accumulators of Your product it means they are covered by European Directive 2006/66/EC.
2. This symbol may be combined with chemical symbols for mercury(Hg), cadmium(Cd) or lead(Pb) if the battery Contains more than 0.0005% of mercury, 0.002% of cadmium or 0.004% of lead.
3. All batteries/accumulators should be disposed separately from the municipal waste stream via designated collection facilities appointed by the government or the local authorities.
4. The correct disposal of Your old batteries/ accumulators will help to prevent potential negative consequences for the environment, animal and human health.
5. For more detailed information about disposal of Your old batteries/ accumulators, please contact Your city office, waste disposal service or the shop where You purchased the product.

For Wireless product European Union Notice

C E 0984

LG Electronics hereby declares that this/these product(s) is/are in compliance with the essential requirements and other relevant provisions of Directive 1999/5/EC, 2004/108/EC, 2006/95/EC, 2009/125/EC and 2011/65/EU.

Please contact to the following address for obtaining a copy of the DoC (Declaration of Conformity).

Contact office for compliance of this product :

LG Electronics Inc.
EU Representative, Krijgsman 1,
1186 DM Amstelveen, The Netherlands

- Please note that this is NOT a Customer Service contact point. For Customer Service Information, see Warranty Card or contact the dealer that you purchased this product.

Indoor use only.

RF Radiation Exposure Statement

This equipment should be installed and operated with minimum distance 20cm between the radiator and your body.

POWER: This unit operates on a mains supply of 200-240V~, 50/60Hz.

WIRING: This unit is supplied with a BSI 1363 approved 13 amp mains plug, fused at 5 amp. When replacing the fuse always use a 5 amp BS 1362, BSI or ASTA approved type. Never use this plug with the fuse cover omitted. To obtain a replacement fuse cover contact your dealer. If the type of plug supplied is not suitable for the mains sockets in your home, then the plug should be removed and a suitable type fitted. Please refer to the wiring instructions below:

WARNING: A mains plug removed from the mains lead of this unit must be destroyed. A mains plug with bared wires is hazardous if inserted in a mains socket. Do not connect either wire to the earth pin, marked with the letter \perp or with the earth symbol or coloured green or green and yellow.

If any other plug is fitted, use a 5 amp fuse, either in the plug, or at the distribution board.

IMPORTANT: The wires in this mains lead are coloured in accordance with the following codes:

- BLUE: NEUTRAL, BROWN: LIVE - As the colours of the wires in the mains lead of this unit may not correspond with the coloured marking identifying the terminals in your plug, proceed as follows: The wire which is coloured blue must be connected to the terminal which is marked with the letter N or coloured black. The wire which is coloured brown must be connected to the terminal which is marked with the letter L or coloured red.



Caution

- Watching a 3D content for a long period time may cause dizziness or tiredness.
- It is not recommended to watch a movie in 3D mode for infirm, child and pregnant woman.
- If you are experiencing headache, tiredness or dizziness while viewing content in 3D, it is strongly recommended to stop the playback and rest until you feel normal.

Notes on Copyrights

- Recording equipment should be used only for lawful copying and you are advised to check carefully what is lawful copying in the area in which you are making a copy. Copying of copyright material such as films or music is unlawful unless permitted by a legal exception or consented to by the rights owner.
- This product incorporates copyright protection technology that is protected by U.S. patents and other intellectual property rights. Use of this copyright protection technology must be authorized by Rovi Corporation, and is intended for home and other limited viewing uses only unless otherwise authorized by Rovi Corporation. Reverse engineering or disassembly is prohibited.
- CONSUMERS SHOULD NOTE THAT NOT ALL HIGH DEFINITION TELEVISION SETS ARE FULLY COMPATIBLE WITH THIS PRODUCT AND MAY CAUSE ARTIFACTS TO BE DISPLAYED IN THE PICTURE. IN CASE OF 625 PROGRESSIVE SCAN PICTURE PROBLEMS, IT IS RECOMMENDED THAT THE USER SWITCH THE CONNECTION TO THE 'STANDARD DEFINITION' OUTPUT. IF THERE ARE QUESTIONS REGARDING OUR TV SET COMPATIBILITY WITH THIS MODEL 625p UNIT PLEASE CONTACT OUR CUSTOMER SERVICE CENTRE.
- Because AACS (Advanced Access Content System) is approved as content protection system for BD format, similar to use of CSS (Content Scramble System) for DVD format, certain restrictions are imposed on playback, analogue signal output, etc., of AACS protected contents. The operation of this product and restrictions on this product may vary depending on your time of purchase as those restrictions may be adopted and/or changed by AACS after the production of this product.
- Furthermore, BD-ROM Mark and BD+ are additionally used as content protection systems for BD format, which imposes certain restrictions including playback restrictions for BD-ROM Mark and/or BD+ protected contents. To obtain additional information on AACS, BD-ROM Mark, BD+, or this product, please contact an authorized Customer Service Centre.
- Many BD-ROM/DVD discs are encoded with copy protection. Because of this, you should only connect your player directly to your TV, not to a VCR. Connecting to a VCR results in a distorted picture from copy-protected discs.

- Under the U.S. Copyright laws and Copyright laws of other countries, unauthorized recording, use, display, distribution, or revision of television programs, videotapes, BD-ROM discs, DVDs, CDs and other materials may subject you to civil and/or criminal liability.

Important Notice for TV colour system

The colour system of this player differs according to currently playing discs.

For example, when the player plays the disc recorded in the NTSC colour system, the image is output as an NTSC signal.

Only the multi system colour TV can receive all signals output from the player.

- If you have a PAL colour system TV, you will see just distorted images when using discs or video contents recorded in NTSC.
- The multi system colour TV changes the colour system automatically according to input signals. In case that the colour system is not changed automatically, turn it off and then on to see normal images on screen.
- Even if the disc recorded in NTSC colour system are well displayed on your TV, these may not be recorded correctly on your recorder.

Table of Contents

1 Getting Started

- 2 Safety Information
- 8 Introduction
- 8 – Playable discs and symbols used in this manual
- 9 – About the “⓪” symbol display
- 9 – Compatibility notes
- 10 – File compatibility
- 11 – Regional Code
- 11 – AVCHD (Advanced Video Codec High Definition)
- 11 – System Requirements
- 11 – Compatibility Notes
- 11 – LG AV Remote
- 12 Remote control
- 13 Main Unit

2 Connecting

- 14 Connections to Your TV
- 14 – Antenna connection to your TV and this unit
- 15 – HDMI Connection
- 16 – Resolution Setting
- 16 Connecting to an Amplifier
- 17 – Connecting to an Amplifier via HDMI Output
- 17 – Connecting to an Amplifier via Digital Audio Output
- 18 Connecting to your Home Network
- 18 – Wired network connection
- 19 – Wired Network Setup
- 20 – Wireless network connection
- 20 – Wireless Network Setup
- 23 USB device connection
- 23 – Playback content in the USB device

3 System Setting

- 24 Auto Set UP
- 25 Home Menu Overview
- 25 – Basic button operations
- 25 Settings

- 25 – Adjust the Setup Settings
- 26 – Settings for Digital TV
- 26 – Scanning programmes automatically (Auto Tuning)
- 26 – Scanning programmes manually (Manual Tuning)
- 27 – Editing Programme List (Channel Edit)
- 27 – Setting the DTV Lock
- 28 – Adjusting DTV Rating
- 28 – Setting the antenna power
- 28 – Setting the Timeshift
- 29 – [DTV] Menu
- 30 – [DISPLAY] Menu
- 31 – [LANGUAGE] Menu
- 32 – [AUDIO] Menu
- 33 – [LOCK] Menu
- 34 – [NETWORK] Menu
- 35 – [OTHERS] Menu

4 Operating

- 38 Using the Digital TV functions
- 38 – Viewing the Digital TV
- 38 – Changing Digital TV programmes
- 38 – Setting favourite programmes
- 39 – Viewing the programme information
- 39 – Selecting DTV audio language
- 39 – Selecting DTV subtitle language
- 39 – Programme Guide (Digital program only)
- 40 – Using the MHEG (Viewing MHEG)
- 41 – Using the timeshift function manually
- 41 – Using the timeshift function automatically
- 42 Recording TV programmes
- 42 – Normal Recording
- 42 – Dual Programme Recording
- 42 – Stop Recording
- 43 – Timer Recording (Manual)
- 43 – Timer Recording (EPG)
- 44 – Canceling a timer recording
- 44 – Editing a timer recording
- 44 – Instant Timer Recording
- 45 General Playback
- 45 – Playing Discs
- 46 – Using the disc menu
- 46 – Resume playback
- 46 – Playing the recorded titles

- 46 - Searching the recorded titles
- 47 - Sorting the recorded titles
- 47 - Playing content contained in the internal hard disk drive
- 48 - Searching content in the hard disk drive by entering file name
- 48 - Playing Blu-ray 3D disc
- 49 Advanced Playback
- 49 - Repeat Playback
- 50 - Repeating a specific portion
- 50 - Changing content list view
- 51 - Viewing content information
- 51 - Selecting a subtitle file
- 51 - Last Scene Memory
- 52 On-Screen display
- 52 - Displaying content information on-screen
- 53 - Playing from selected time
- 53 - Hearing different audio
- 53 - Selecting a subtitle language
- 54 - Watching from a different angle
- 54 - Changing the TV Aspect Ratio
- 54 - Changing the Picture Mode
- 55 Copying
- 55 - Copying file(s)/folder(s) to the internal hard disk drive
- 56 - Copying file(s)/folder(s) from the internal hard disk drive to a USB storage device
- 58 - Deleting a file(s)/folder(s)
- 58 - Naming a file/folder
- 59 Enjoying BD-LIVE
- 59 - Playing a file on a network server
- 60 - Wi-Fi Direct™ Connection
- 62 Playing movie file and VR discs
- 63 - Selecting a subtitle file
- 63 - Changing subtitle code page
- 64 Viewing a photo
- 65 - Options while viewing a photo
- 65 - Listening to music during a slide show
- 66 Listening to music
- 67 - Audio CD Recording
- 68 - Viewing information from Gracenote Media Database
- 69 - Using the Music Library
- 71 - Using the Photo Library
- 71 Using the Premium
- 72 Using the LG Apps

- 72 - Signing in
- 72 - Managing my Apps
- 73 - Searching online content

5 Troubleshooting

- 74 Troubleshooting
- 74 - General
- 74 - Picture
- 75 - Sound
- 75 - Network
- 76 - Recording
- 76 - Customer Support
- 76 - Open source software notice

6 Appendix

- 77 Controlling a TV with the Supplied Remote Control
- 77 - Setting up the remote to control your TV
- 78 Area Code List
- 79 Language code List
- 80 Trademarks and Licenses
- 82 Network Software Update
- 82 - Network update notification
- 83 - Software Update
- 84 MediaHome 4 Essentials
- 84 - System requirements
- 84 - Installing Nero MediaHome 4 Essentials
- 85 - Sharing files and folders
- 86 Audio Output Specifications
- 87 About the internal hard disk drive
- 88 Video Output Resolution
- 89 Specifications
- 90 Maintenance
- 90 - Notes on Discs
- 90 - Handling the Unit
- 91 Important Information Relating to Network Services

1

2

3













4

5

6

Introduction

Playable discs and symbols used in this manual

Media/Term	Logo	Symbol	Description
Blu-ray	  	BD	<ul style="list-style-type: none"> Discs such as movies that can be purchased or rented. "Blu-ray 3D" discs and "Blu-ray 3D ONLY" discs. BD-R/RE discs that are recorded in BDAV format.
		MOVIE MUSIC PHOTO	<ul style="list-style-type: none"> BD-R/RE discs that contain Video, Audio or Photo files. ISO 9660+JOLIET, UDF and UDF Bridge format
DVD-ROM DVD-R DVD-RW DVD+R DVD+RW (8 cm, 12 cm)	    	DVD	<ul style="list-style-type: none"> Discs such as movies that can be purchased or rented. Video mode and finalized only Supports the dual layer disc also
		AVCHD	Finalized AVCHD format
		MOVIE MUSIC PHOTO	<ul style="list-style-type: none"> DVD±R/RW discs that contain Video, Audio or Photo files. ISO 9660+JOLIET, UDF and UDF Bridge format
DVD-RW (VR) (12 cm)		DVD	VR mode and finalized only
Audio CD (12 cm)		ACD	Audio CD
CD-R/RW (8 cm, 12 cm)		MOVIE MUSIC PHOTO	<ul style="list-style-type: none"> CD-R/RW discs that contain Video, Audio or Photo files. ISO 9660+JOLIET, UDF and UDF Bridge format
HDD	-	MOVIE MUSIC PHOTO	Movie, Music, Photo files contained in the HDD
		REC	Titles recorded via this unit
Note	-		Indicates special notes and operating features.
Caution	-		Indicates cautions for preventing possible damages from abuse.

! Note

- Depending on the conditions of the recording equipment or the CD-R/RW (or DVD-R/RW) disc itself, some CD-R/RW (or DVD±R/RW) discs cannot be played on the unit.
- Depending on the recording software & the finalization, some of recorded discs (CD-R/RW or DVD±R/RW) may not be playable.
- BD-R/RE, DVD±R/RW and CD-R/RW discs recorded using a personal computer or a DVD or CD Recorder may not play if the disc is damaged or dirty, or if there is dirt or condensation on the player's lens.
- If you record a disc using a personal computer, even if it is recorded in a compatible format, there are cases in which it may not play because of the settings of the application software used to create the disc. (Check with the software publisher for more detailed information.)
- This unit requires discs and recordings to meet certain technical standards in order to achieve optimal playback quality.
- Pre-recorded DVDs are automatically set to these standards. There are many different types of recordable disc formats (including CD-R containing MP3 or WMA files) and these require certain pre-existing conditions to ensure compatible playback.
- Customers should note that permission is required in order to download MP3 / WMA files and music from the Internet. Our company has no right to grant such permission. Permission should always be obtained from / guaranteed by the copyright owner.
- You have to set the disc format option to [Mastered] in order to make the discs compatible with the LG players when formatting rewritable discs. If you set the option to "Live System", the disc cannot be played on LG player. (Mastered/Live File System : Disc format system for windows Vista)
- The drive is slot looking you should insert only round 77 or 120 mm disc. The drive does not work with irregularly shaped discs, which could damage the drive if inserted.

About the "⊘" symbol display

"⊘" may appear on your TV display during operation and indicates that the function explained in this owner's manual is not available on that specific media.

Compatibility notes

- Because BD-ROM is a new format, certain disc, digital connection and other compatibility issues are possible. If you experience compatibility problems, please contact an authorized Customer Service Center.
- This unit allows you to enjoy functions such as picture-in-picture, secondary audio and Virtual packages, etc., with BD-ROM supporting BONUSVIEW (BD-ROM version 2 Profile 1 version 1.1). Secondary video and audio can be played from a disc compatible with the picture-in-picture function. For the playback method, refer to the instructions in the disc.
- Viewing high-definition content and up-converting standard DVD content may require a HDMI-capable input or HDCP-capable DVI input on your display device.
- Some BD-ROM and DVD discs may restrict the use of some operation commands or features.
- Dolby TrueHD, Dolby Digital Plus and DTS-HD are supported with maximum 7.1 channels if you use HDMI connection for the audio output of the unit.
- You can use a USB device to store some disc related information, including downloaded online content. The disc you are using will control how long this information is retained.

File compatibility

Overall

Available File extensions: ".jpg", ".jpeg", ".png", ".avi", ".divx", ".mpg", ".mpeg", ".mkv", ".mp4", ".mp3", ".wav", ".wma", ".ts"

- There could be a variance on the available file extensions depending on DLNA server.
- The file name is limited to 180 characters.
- Depending on the size and number of the files, it may take several minutes to read the contents on the media.

Maximum Files/Folder: Less than 2000 (total number of files and folders)

CD-R/RW, DVD±R/RW, BD-R/RE Format: ISO 9660+JOLIET, UDF and UDF Bridge format

MOVIE

Available resolution: 1920 x 1080 (W x H) pixels

Playable subtitle: SubRip (.srt / .txt), SAMI (.smi), SubStation Alpha (.ssa/.txt), MicroDVD (.sub/.txt), VobSub (.sub), SubViewer 1.0 (.sub), SubViewer 2.0 (.sub/.txt), DVD Subtitle System (.txt), TMLayer (.txt)

Playable Codec format: "DIVX 3.11", "DIVX4", "DIVX5", "DIVX6", "XVID" (Standard playback only), H.264/MPEG-4 AVC, DIVX-HD, MPEG1 SS, MPEG2 PS, MPEG2 TS

Playable Audio format: "Dolby Digital", "DTS", "MP3", "WMA", "AAC", "AC3"

- Not all the WMA and AAC Audio formats are compatible with this unit.

Sampling frequency: within 32-48 kHz (WMA), within 16-48 kHz (MP3)

Bit rate: within 20-320 kbps (WMA), within 32-320 kbps (MP3)

Note

- HD movie files contained on the CD or USB 1.0/1.1 may not be played properly. BD, DVD or USB 2.0 are recommended to play back HD movie files.
- This player supports H.264/MPEG-4 AVC profile Main, High at Level 4.1. For a file with higher level, there will be an warning message on the screen.
- This player does not support the file that are recorded with GMC*¹ or Qpel*². Those are video encoding techniques in MPEG4 standard, like DivX or XVID.
 - *1 GMC – Global Motion Compensation
 - *2 Qpel – Quarter pixel
- HD movie files that need high performance playback could react slowly.
- The total playback time indicated on the screen may not be correct for .ts files.

MUSIC

Sampling frequency: between 8 - 48 kHz (WMA), within 11 - 48 kHz (MP3), 44.1 and 48 kHz (LPCM)

Bit rate: between 8 - 320 kbps (WMA, MP3), 768 kbps and 1.536 Mbps (LPCM)

Note

- This unit cannot support the ID3 Tag embedded MP3 file.
- The total playback time indicated on the screen may not be correct for VBR files.

PHOTO

Recommended size:

Less than 4,000 x 3,000 x 24 bit/pixel
Less than 3,000 x 3,000 x 32 bit/pixel

- Progressive and lossless compression photo image files are not supported.
- Depending on the size and number of the photo files, it may take several minutes to read the contents of the media.
- This player can not display thumbnail image in some files.

Regional Code

This unit has a regional code printed on the rear of the unit. This unit can play only BD-ROM or DVD discs labelled same as the rear of the unit or "ALL".

AVCHD (Advanced Video Codec High Definition)

- This player can playback AVCHD format discs. These discs are normally recorded and used in camcorders.
- The AVCHD format is a high definition digital video camera format.
- The MPEG-4 AVC/H.264 format is capable of compressing images at higher efficiency than the conventional image compressing format.
- Some AVCHD discs use the "x.v.Color" format.
- This player can playback AVCHD discs using "x.v.Color" format.
- Some AVCHD format discs may not be played, depending on the recording condition.
- AVCHD format discs need to be finalized.
- "x.v.Color" offers a wider colour range than normal DVD camcorder discs.

System Requirements

For high definition video playback:

- High definition display that has COMPONENT or HDMI input jacks.
- BD-ROM disc with high definition content.
- HDMI or HDCP capable DVI input on your display device is required for some content (as specified by disc authors).
- For up-conversion of standard definition DVD, a HDMI or HDCP capable DVI input on your display device is required for copy-protected content.

For Dolby® Digital Plus, Dolby TrueHD and DTS-HD multi-channel audio playback:

- An amplifier/receiver with a built-in (Dolby Digital, Dolby Digital Plus, Dolby TrueHD, DTS or DTS-HD) decoder.
- Main, centre, surround speakers and subwoofer as necessary for chosen format.

Compatibility Notes

- Because BD-ROM is a new format, there can be issues regarding certain disc, digital connection and other compatibility issues. If you experience compatibility problems, please contact an authorized Customer Service Center.
- Viewing high-definition content and up-converting standard DVD content may require a HDMI-capable input or HDCP-capable DVI input on your display device.
- Some BD-ROM and DVD discs may restrict the use of some operation commands or features.
- Dolby TrueHD, Dolby Digital Plus and DTS-HD are supported with maximum 7.1 channels if you use HDMI connection as the audio output.
- You can use a USB device that is used to store some disc related information, including downloaded on-line content. The disc you are using will control how long this information is retained.
- While watching 3D contents, on-screen displayed may not be displayed properly. To display proper on-screen display, turn off 3D mode on TV.

LG AV Remote

You can control this player with your iPhone or Android phone via your home network.

This player and your phone must be connected to your wireless network device such as access point. Visit "Apple iTunes" or "Google Android Market (Google Play Store)" for detailed information of "LG AV Remote".

Remote control

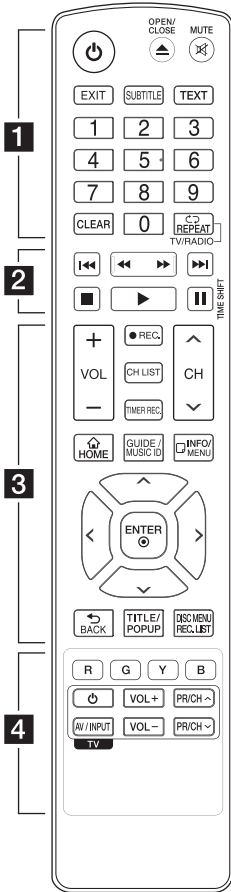

Battery Installation

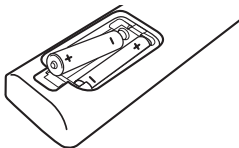

Remove the battery cover on the rear of the Remote Control, and insert two R03 (size AAA) batteries with **+** and **-** matched correctly.

..... **1**

⏻ (POWER): Switches the player ON or OFF.

⏮ (OPEN/CLOSE): Opens and closes the disc tray.

MUTE (🔇): Mutes the sound.

EXIT: Exits a menu or hides on-screen information.

SUBTITLE: Selects a subtitle language.

TEXT: Switches between teletext mode and normal TV viewing.

0-9 numerical buttons: Selects numbered options in a menu.

CLEAR: Removes a mark on the search menu or a number when setting the password.

REPEAT (↺): Repeats a desired section or sequence.

TV/RADIO: Switches between TV and radio modes.

..... **2**

⏮/⏭ (SCAN): Searches backward or forward.

⏮/⏭ (SKIP): Goes to the next or previous chapter / track / file.

■ (STOP): Stops playback.

▶ (PLAY): Starts playback.

⏸ (PAUSE): Pauses playback.

TIME SHIFT: Activates pause live TV/playback (timeshift) for a live TV programme.

..... **3**

VOL (-/+): Adjusts the sound level of the unit.

REC. (●): Starts recording.

CH LIST: Displays the Channel list.

TIMER REC.: Displays [Timer Recording] menu.

CH (-/+): Scans up or down through memorized programmes.

HOME (🏠): Displays or exits the [Home Menu].

GUIDE: Displays the EPG menu.

MUSIC ID: When connected to the network, can provide information about the current song while video playback.

INFO/MENU (ℹ): Displays or exits On-Screen Display.

Direction buttons: Selects an option in the menu.

ENTER (⊙): Acknowledges menu selection.

BACK (↶): Exits the menu or returns to the previous screen.

TITLE/POP UP: Displays the DVD title menu or BD-ROM's pop-up menu, if available.

DISC MENU/REC.LIST:

Accesses menu on a disc or switches between recording list menu.

..... **4**

Coloured (R, G, Y, B) buttons:

Use to navigate BD-ROM menus. They are also used for [MOVIE], [PHOTO], [MUSIC], [Premium], [LG Apps] and [DTV] menu.

TV Control Buttons: See page 77

Main Unit

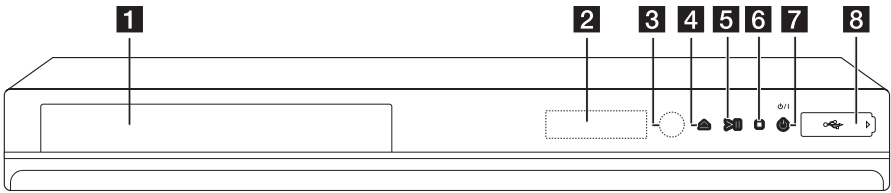

- 1** Disc Tray
- 2** Display window
- 3** Remote Sensor
- 4** △ (Open/Close)
- 5** >|| (Play/Pause)
- 6** □ (Stop)
- 7** ⏻ (Power)
- 8** USB Port

This port is not for recording with USB HDD.
To record the TV program, use the USB port on the rear panel of the unit.

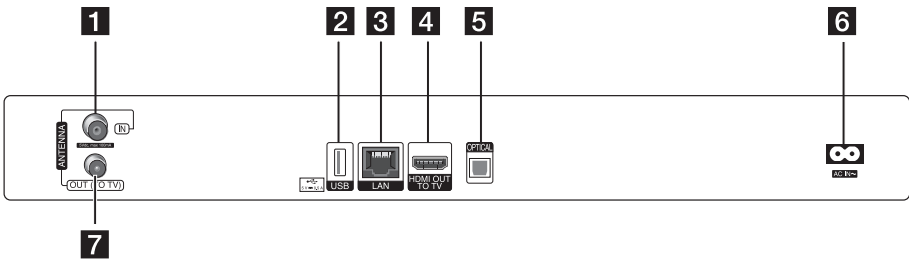

- 1** ANTENNA IN
- 2** USB Port
If you want to record on external HDD, connect external HDD to unit.
- 3** LAN port
- 4** HDMI OUT (TO TV)
- 5** OPTICAL (DIGITAL AUDIO OUT)
- 6** AC IN connector
Connect the supplied power cord.
- 7** ANTENNA OUT (TO TV)

Connections to Your TV

Make one of the following connections, depending on the capabilities of your existing equipment.

- Antenna connection (page 14)
- HDMI connection (page 15)

! Note

- Depending on your TV and other equipment you wish to connect, there are various ways you could connect the unit. Use only one of the connections described in this manual.
- Please refer to the manuals of your TV, Stereo System or other devices as necessary to make the best connections.
- Make sure the player is connected directly to the TV. Tune the TV to the correct video input channel.
- Do not connect the player's AUDIO OUT jack to the phono in jack (record player) of your audio system.
- Do not connect your player via your VCR. The image could be distorted by the copy protection system.

Antenna connection to your TV and this unit

Connect one end of the RF cable to ANTENNA OUT(TO TV) jack on the unit and other end to ANTENNA IN jack on your TV. Passes the signal from the ANTENNA IN jack to your TV/monitor.

Connect the Terrestrial TV antenna to the ANTENNA IN jack on the unit. If you want to use an indoor antenna, use one with a signal amplifier rated at 5V, 100mA and set [Antenna 5V] to [ON] in the setup menu (See page 28).

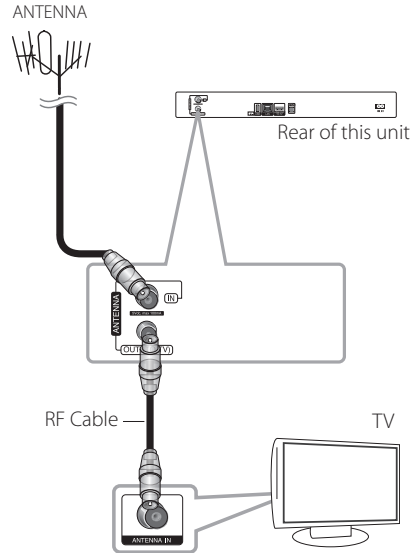

HDMI Connection

If you have a HDMI TV or monitor, you can connect it to this unit using a HDMI cable (Type A, High Speed HDMI™ Cable). Connect the HDMI jack on the unit to the HDMI jack on a HDMI compatible TV or monitor.

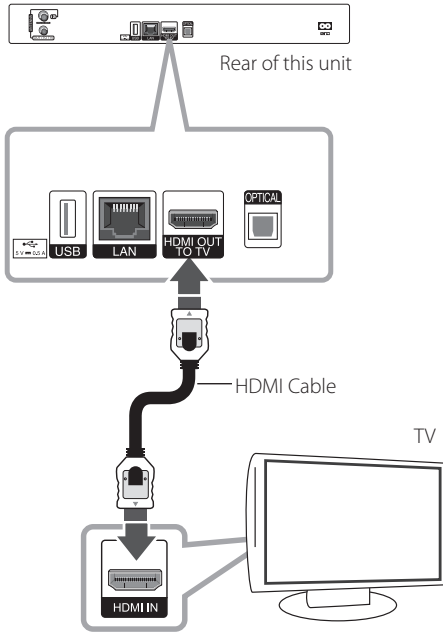

Set the TV's source to HDMI (refer to TV's Owner's manual).

! Note

- If a connected HDMI device does not accept the audio output of the unit, the HDMI device's audio sound may be distorted or may not output.
- When you use HDMI connection, you can change the resolution for the HDMI output. (Refer to "Resolution Setting" on page 16.)
- Select the type of video output from the HDMI OUT jack using [HDMI Color Setting] option on the [Setup] menu (see page 31).
- Changing the resolution when the connection has already been established may result in malfunctions. To solve the problem, turn off the player and then turn it on again.
- When the HDMI connection with HDCP is not verified, TV screen is changed to black screen. In this case, check the the HDMI connection, or disconnect the HDMI cable.
- If there is noise or lines on the screen, please check the HDMI cable (length is generally limited to 4.5m).

Additional Information for HDMI

- When you connect a HDMI or DVI compatible device make sure of the following:
 - Try switching off the HDMI/DVI device and this player. Next, switch on the HDMI/DVI device and leave it for around 30 seconds, then switch on this player.
 - The connected device's video input is set correctly for this unit.
 - The connected device is compatible with 720x576p, 1280x720p, 1920x1080i or 1920x1080p video input.
- Not all HDCP-compatible HDMI or DVI devices will work with this player.
 - The picture will not be displayed properly with non-HDCP device.
 - This player does not playback and TV screen is changed to black screen.

Resolution Setting

The player provides several output resolutions for HDMI OUT and COMPONENT VIDEO OUT jacks. You can change the resolution using [Setup] menu.

1. Press HOME (🏠).
2. Use </> to select the [Setup] and press ENTER (⊙). The [Setup] menu appears.



3. Use ^/∨ to select [DISPLAY] option then press > to move to the second level.



4. Use </> to select the [Resolution] option then press ENTER (⊙) to move to the third level.

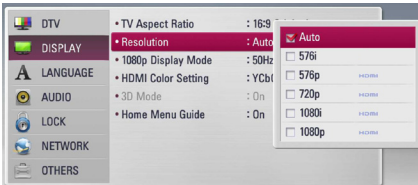

5. Use ^/∨ to select the desired resolution then press ENTER (⊙) to confirm your selection.

Connecting to an Amplifier

Make one of the following connections, depending on the capabilities of your existing equipment.

- HDMI Audio connection (page 17)
- Digital Audio connection (page 17)

Since many factors affect the type of audio output, see "Audio Output Specifications" for details (pages 86-87).

About Digital Multi-channel sound

A digital multi-channel connection provides the best sound quality. For this, you need a multi-channel Audio/Video Receiver that supports one or more of the audio formats supported by your unit. Check the receiver manual and the logos on the front of the receiver. (PCM Stereo, PCM Multi-Ch, Dolby Digital, Dolby Digital Plus, Dolby TrueHD, DTS and/or DTS-HD)

Connecting to an Amplifier via HDMI Output

Connect the player's HDMI OUT jack to the corresponding in jack on your amplifier using a HDMI cable. You will need to activate the player's digital output. (See "[AUDIO] Menu" on pages 32-33.)

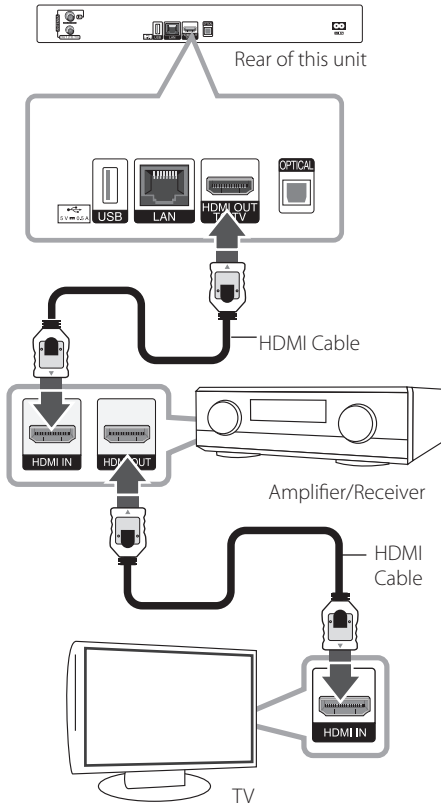

Connect the amplifier's HDMI output jack to HDMI input jack on your TV using a HDMI cable if your amplifier has HDMI output jack.

Connecting to an Amplifier via Digital Audio Output

Connect the player's OPTICAL (DIGITAL AUDIO OUT) jack to the corresponding in jack (OPTICAL) on your amplifier.

Use an optional digital (optical) audio cable. You will need to activate the unit's digital output. (See "[AUDIO] Menu" on pages 32-33.)

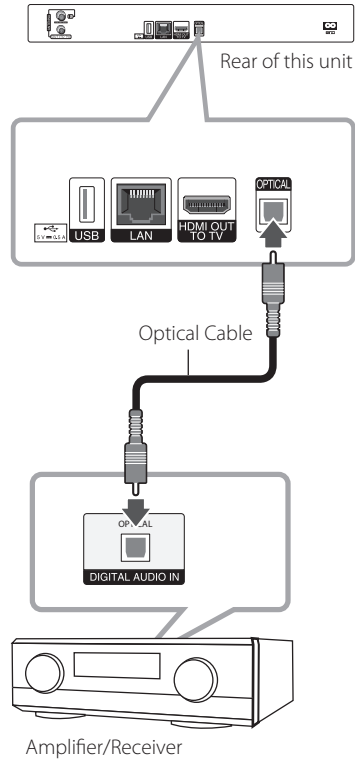

Connecting to your Home Network

This unit can be connected to a local area network (LAN) via the LAN port on the rear panel or the internal wireless module.

By connecting the unit to a broadband home network, you have access to services such as software updates, BD-Live interactivity and streaming services.

Wired network connection

Using a wired network provides the best performance, because the attached devices connect directly to the network and are not subject to radio frequency interference.

Please refer to the documentation for your network device for further instructions.

Connect the player's LAN port to the corresponding port on your Modem or Router using a commercially available LAN or Ethernet cable.

! Note

- When plugging or unplugging the LAN cable, hold the plug portion of the cable. When unplugging, do not pull on the LAN cable but unplug while pressing down on the lock.
- Do not connect a modular phone cable to the LAN port.
- Since there are various connection configurations, please follow the specifications of your telecommunication carrier or internet service provider.
- If you want to access content from PCs or DLNA servers, this unit must be connected to the same local area network with them via a router.

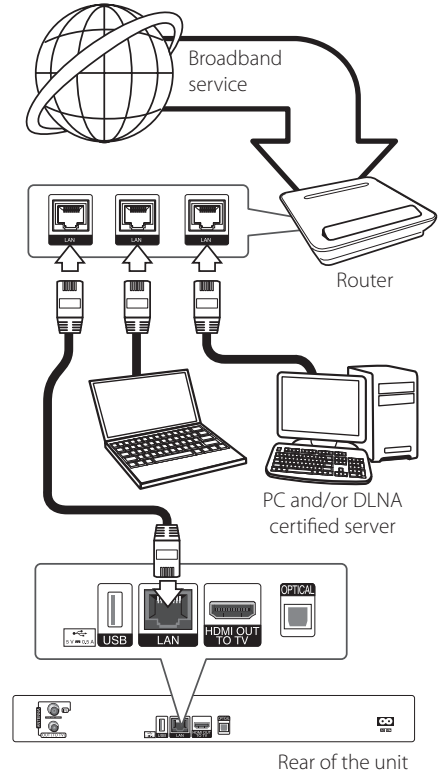

Wired Network Setup

If there is a DHCP server on the local area network (LAN) via wired connection, this player will automatically be allocated an IP address. After making the physical connection, a small number of home networks may require the player's network setting to be adjusted. Adjust the [NETWORK] setting as follow.

Preparation

Before setting the wired network, you need to connect the broadband internet to your home network.

1. Select [Connection Setting] option in the [Setup] menu then press ENTER (⊙).

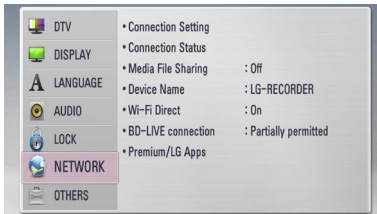

2. The [Connection Setting] menu will appear on the screen. Use \wedge / \vee to select the [Wired] and press ENTER (⊙).



3. Select [Yes] and press ENTER (⊙) to continue. The new connection settings reset the current network settings.
4. Use $\wedge / \vee / \lt / \gt$ to select the IP mode between [Dynamic] and [Static]. Normally, select [Dynamic] to allocate an IP address automatically.

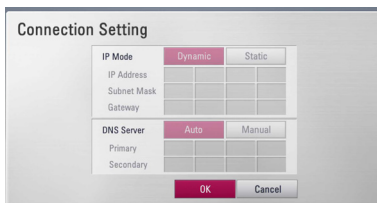

Note

If there is no DHCP server on the network and you want to set the IP address manually, select [Static] then set [IP Address], [Subnet Mask], [Gateway] and [DNS Server] using $\wedge / \vee / \lt / \gt$ and numerical buttons. If you make a mistake while entering a number, press CLEAR to clear the highlighted part.

4. Select [OK] and press ENTER (⊙) to apply network settings.
5. The player will ask you to test the network connection. Select [OK] and press ENTER (⊙) to complete the network connection.
6. If you select [Test] and press ENTER (⊙) at step 5 above, the network connection status is displayed on the screen. You can also test it on the [Connection Status] in the [Setup] menu.

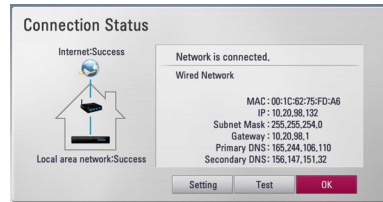

Wireless network connection

Another connection option is to use an Access Point or a wireless router. The network configuration and connection method may vary depending on the equipment in use and the network environment.

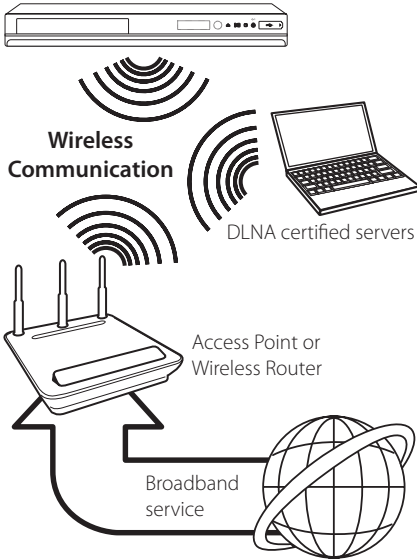

Refer to the setup instructions supplied with your access point or wireless router for detailed connection steps and network settings.

For best performance, a direct wired connection from this player to your home network's router or cable/DSL modem is always the best option. If you do choose to use the wireless option, note that performance can sometimes be affected by other electronic devices in the home.

Wireless Network Setup

For the wireless network connection, the player needs to be set up for network communication. This adjustment can be done from the [Setup] menu. Adjust the [NETWORK] setting as follows. Setting up the access point or the wireless router is required before connecting the player to the network.

Preparation

Before setting the wireless network, you need to:

- connect the broadband internet to the wireless home network.
 - set the access point or wireless router.
 - note the SSID and security code of the network.
1. Select [Connection Setting] option in the [Setup] menu then press ENTER (⊙).

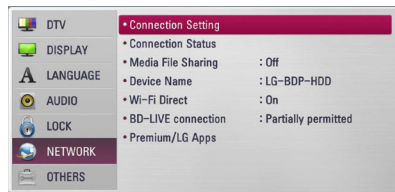

2. The [Connection Setting] menu appears on the screen. Use \wedge / \vee to select [Wireless] and press ENTER (⊙).

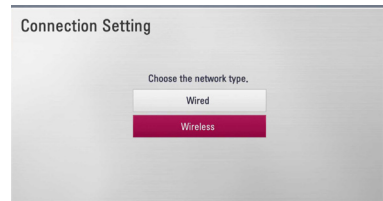

3. Select [Yes] and press ENTER (⊙) to continue. The new connection settings reset the current network settings.

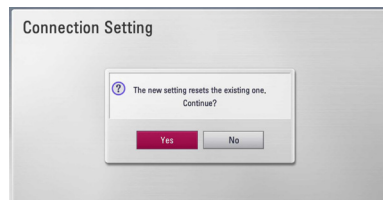

4. The player scans all available access points or wireless routers within range and displays them as a list. Use \wedge / \vee to select an access point or wireless router on the list, and then press ENTER (⊙).

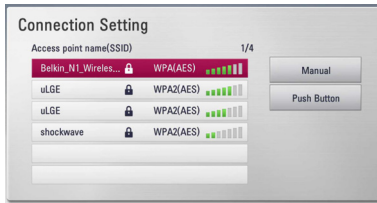

If you have security on your access point or wireless router, verify that the WEP or WPA key that was entered into the player matches the router's information exactly. You need to input the security code as necessary.

! Note

- WEP security mode generally have 4 keys available on an access point or wireless router's setting. If your access point or wireless router uses WEP security, enter the security code of the key "No.1" to connect on your home network.
- An Access Point is a device that allows you to connect to your home network wirelessly.

[Manual] – Your access point may not be broadcasting its access point name (SSID). Check your router settings through your computer and either set your router to broadcast SSID, or manually enter the access point name (SSID) in [Manual].

[Push Button] – If your access point or wireless router supports the Push Button Configuration method, select this option and press the Push Button on your access point or wireless router within 120 counts. You do not need to know the access point name (SSID) and security code of your access point or wireless router.

5. Use $\wedge / \vee / < / >$ to select the IP mode between [Dynamic] and [Static]. Normally, select [Dynamic] to allocate an IP address automatically.

! Note

If there is no DHCP server on the network and you want to set the IP address manually, select [Static] then set [IP Address], [Subnet Mask], [Gateway] and [DNS Server] using $\wedge / \vee / < / >$ and numerical buttons. If you make a mistake while entering a number, press CLEAR to clear the highlighted part.

6. Select [OK] and press ENTER (⊙) to apply network settings.
7. The player will ask you to test the network connection. Select [OK] and press ENTER (⊙) to complete the network connection.
8. If you select [Test] and press ENTER (⊙) at step 7 above, the network connection status is displayed on the screen. You can also test it on the [Connection Status] in the [Setup] menu.

Notes on Network Connection:

- Many network connection problems during set up can often be fixed by re-setting the router or modem. After connecting the player to the home network, quickly power off and/or disconnect the power cable of the home network router or cable modem. Then power on and/or connect the power cable again.
- Depending on the internet service provider (ISP), the number of devices that can receive internet service may be limited by the applicable terms of service. For details, contact your ISP.
- Our company is not responsible for any malfunction of the player and/or the internet connection feature due to communication errors/malfunctions associated with your broadband internet connection, or other connected equipment.
- The features of BD-ROM discs made available through the Internet Connection feature are not created or provided by our company, and our company is not responsible for their functionality or continued availability. Some disc related material available by the Internet Connection may not be compatible with this player. If you have questions about such content, please contact the producer of the disc.
- Some internet content may require a higher bandwidth connection.
- Even if the player is properly connect and configured, some internet content may not operate properly because of internet congestion, the quality or bandwidth of your internet service, or problems at the provider of the content.
- Some internet connection operations may not be possible due to certain restrictions set by the Internet service provider (ISP) supplying your broadband Internet connection.
- Any fees charged by an ISP including, without limitation, connection charges are your responsibility.
- A 10 Base-T or 100 Base-TX LAN port is required for wired connection to this player. If your internet service does not allow for such a connection, you will not be able to connect the player.
- You must use a Router to use xDSL service.
- A DSL modem is required to use DSL service and a cable modem is required to use cable modem service. Depending on the access method of and subscriber agreement with your ISP, you may not be able to use the internet connection feature contained in this player or you may be limited to the number of devices you can connect at the same time. (If your ISP limits subscription to one device, this player may not be allowed to connect when a PC is already connected.)
- The use of a "Router" may not be allowed or its usage may be limited depending on the policies and restrictions of your ISP. For details, contact your ISP directly.
- The wireless network operate at 2.4GHz radio frequencies that are also used by other household devices such as cordless telephone, *Bluetooth*® devices, microwave oven, and can be affected by interference from them.
- Turn off all unused network equipment in your local home network. Some devices may generate network traffic.
- For the purpose of the better reception place the player as close as possible to the access point.
- In some instances, placing the access point or wireless router at least 0.45 m above the floor may improve the reception.
- Move closer to the access point if possible or re-orient the player so there is nothing between it and the access point.
- The reception quality over wireless depends on many factors such as type of the access point, distance between the player and access point, and the location of the player.
- Set your access point or wireless router to Infrastructure mode. Ad-hoc mode is not supported.

USB device connection

This unit can play movie, music and photo files contained on a USB device.

Playback content in the USB device

1. Insert a USB device into the USB port until it fits into place.

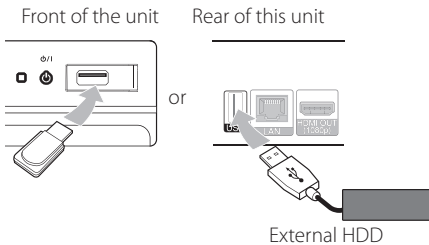

2. Press HOME ().
3. Select [Movie], [Photo] or [Music] using \leftarrow/\rightarrow , and press ENTER ().

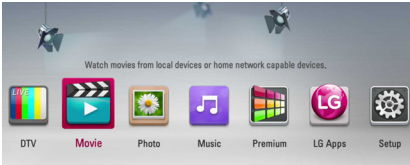

4. Select the [USB] option using \wedge/\vee , and press ENTER ().



5. Select a file using $\wedge/\vee/\leftarrow/\rightarrow$, and press \blacktriangleright (PLAY) or ENTER () to play the file.

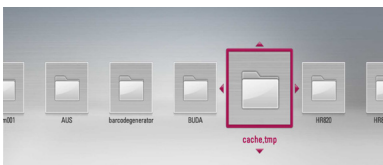

6. Withdraw the USB device carefully after exiting the USB mode.

! Note

- This unit supports USB flash memory/ external HDD formatted in FAT16, FAT32 and NTFS when accessing files (music, photo, movie). However, for BD-Live, only FAT16 and FAT32 formats are supported. The USB device can be used for local storage for enjoying BD-Live discs from the Internet.
- Please use the Internal HDD or USB flash memory/external HDD formatted in either FAT16 or FAT32 when using BD-Live.
- This unit can support up to 4 partitions of the USB device.
- Do not extract the USB device during operation (play, recording, etc.).
- A USB device which requires additional programme installation when you have connected it to a computer, is not supported.
- USB device: USB device that supports USB1.1 and USB2.0.
- Movie, Music and photo files can be played. For details of operations on each file, refer to relevant pages.
- Regular back up is recommended to prevent data loss.
- If you use a USB extension cable or USB HUB or USB multi card reader, the USB device may not be recognized.
- Some USB device may not work with this unit.
- Digital camera and mobile phone are not supported.
- The USB Port on this unit cannot be connected to a PC. The unit cannot be used as a storage device.
- Unformatted media cannot be used. Please format before using.
- If USB HDD cannot be recognized, try another different USB cable.
- Some USB cables may not supply enough current for normal USB operation.
- Files over 4GB are supported with NTFS format.

Auto Set UP

You can reset the recorder to all its factory settings. Some options cannot be reset (Rating and Password). The [Auto Setup] menu appears on the screen after the factory settings.

Step 1. Language Setting

1. Use $\wedge / \vee / < / >$ to select a language for the on-screen display, and press ENTER (⊙).



Step 2. Channel Setting

1. Use $\wedge / \vee / < / >$ to select a country, and press ENTER (⊙).
2. While the Start option is selected, and press ENTER (⊙) to begin the channel search.

If you want to search channels in numerical order, uncheck the box [Automatic Numbering] by using ENTER (⊙)



The recorder automatically searches for and saves the programmes.

If you select [Stop], the [Channel Setting] function will be skipped.

3. Press ENTER (⊙).

Step 3. Time Setting

1. Use $< / >$ to select an option among [Manual] or [Auto], and press ENTER (⊙).



Auto: Set the programme that broadcasts a clock signal and the clock will be set automatically.

If the time that has automatically set is not correct comparing your local time, you can set additional time option.

Manual: If there is no channel that broadcasts a clock signal in your area, you can set the time and date manually. Use \wedge / \vee to select each field, and input correct time and date using $< / >$. You can use numerical buttons.

2. Press ENTER (⊙) to complete the time setting.

Step 4. Network Setting

1. Refer to "Wired network connection" on pages 18-19 to complete the [Wired] setup option, and press ENTER (⊙).
Select [No] and press ENTER (⊙) to cancel.
2. Refer to "Wireless network connection" on pages 20-22 to complete the [Wireless] option, and press ENTER (⊙).

Select [Cancel] and press ENTER (⊙) to cancel. This recorder can apply only one network setup between [Wired] and [Wireless]. If you already set the [Wired] at step 6, you do not need to set [Wireless] setting.

Home Menu Overview

To access numerous functions of the unit, press HOME on the remote.

Basic button operations

HOME: Accesses or removes the Home Menu.

$\wedge / \vee / < / >$: Used to navigate on-screen displays.

ENTER (⊙): Acknowledges menu selection.

BACK (⏪): Exits the menu.

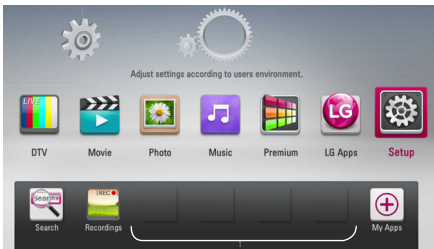

Favorite Apps

[DTV] - You can watch digital broadcasts.
(pages 38-45)

[Movie] - Plays video contents.

[Photo] - Plays photo contents.

[Music] - Plays audio contents.

[Premium] - Displays the Premium Home screen.

[LG Apps] - Displays the [LG Apps] screen.

[Setup] - Adjusts the system settings.

[Search] - Searches an online content by inputting a keyword on the search menu.

[Recording] - Displays [Recording] menu.

[Favorite Apps] - Shortcut for user's favorite Apps.

[My Apps] - Displays the [My Apps] screen.

Settings

Adjust the Setup Settings

You can change the settings of the player in the [Setup] menu.

1. Press HOME (🏠).

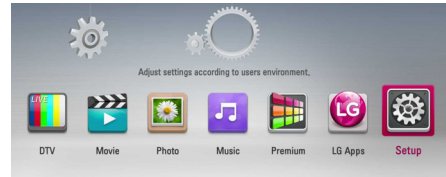

2. Use $< / >$ to select [Setup] and press ENTER (⊙). The [Setup] menu appears.



3. Use \wedge / \vee to select the first setup option, and press $>$ to move to the second level.

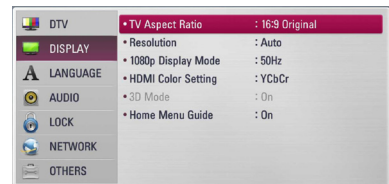

4. Use \wedge / \vee to select a second setup option, and press ENTER (⊙) or $>$ to move to the third level.

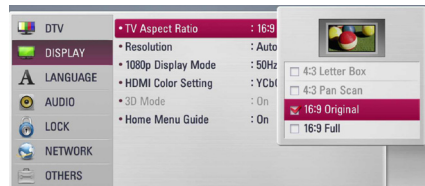

5. Use \wedge / \vee to select a desired setting, and press ENTER (⊙) or $>$ to confirm your selection.

Settings for Digital TV

To use DTV functions, this recorder needs some settings in advance.

Scanning programmes automatically (Auto Tuning)

All available digital TV or radio programmes are searched for and stored automatically based on the selected country.

1. Press HOME.
2. Use $\langle \rangle$ to select [Setup], and press ENTER (⊙).
3. Use \wedge / \vee to select [DTV], and press ENTER (⊙).
4. Use \wedge / \vee to select [Auto Tuning] and press ENTER (⊙).

If you do not want to search the channel in order of number. Please uncheck [Automatic Numbering] by using ENTER (⊙).

5. Use \vee to select [Start], and press ENTER (⊙) to begin the channel search.

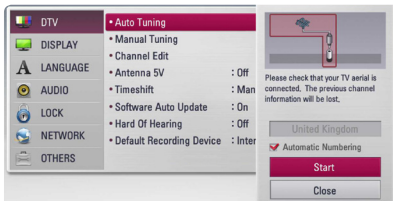

Select [Stop] and press ENTER (⊙) to stop the scanning programmes.

! Note

If the [DTV Lock] option is set to [Lock], this function is available when you enter the password correctly. (see page 27.)

Scanning programmes manually (Manual Tuning)

Scans digital TV or radio programmes and adds the detected programmes to the programme list.

1. Display [Setup] menu.
2. Use \wedge / \vee to select [DTV], and press ENTER (⊙).
3. Use \wedge / \vee to select [Manual Tuning] and press ENTER (⊙) to display the [Manual Tuning] menu.



4. Use $\wedge / \vee / \langle \rangle$ to select the desired multiplexer (MUX), and the unit starts scanning automatically.
5. Use \vee to select the [Add] and press ENTER (⊙) to add the programme the unit scans automatically.

! Note

If the [DTV Lock] option is set to [Lock], this function is available when you enter the password correctly. (see page 27.)

Editing Programme List (Channel Edit)

You can remove any digital TV or radio programs stored on this recorder using the [Channel Edit] menu.

1. Display [Setup] menu.
2. Use \wedge/\vee to select [DTV], and press ENTER (⊙).
3. Use $\wedge/\vee/\langle/\rangle$ to select [Channel Edit] and press ENTER (⊙).
4. Press \wedge to select [DTV] and use \langle/\rangle to select [DTV] or [Radio] programme list.



5. Use $\wedge/\vee/\langle/\rangle$ to select a programme you want to skip from the list, and press red (R) coloured button.

If you do not want to skip the programme, select the programme and press red (R) coloured button again.

Use $\wedge/\vee/\langle/\rangle$ to select a programme you want to lock from the list, and press blue (B) coloured button.

If you do not want to lock the programme, select the programme and press blue (B) coloured button again.

6. Press BACK (⏪) to return to the previous step.

Skip : If the programme is assigned to skip, you can't select that programme with PR button in Remote control.

Block/unblock : If the programme is assigned to block and [DTV Lock] in the [Setup] menu is set to [Lock], you should enter the password to watch the programme.

Setting the DTV Lock

Allows you to activate or deactivate all of the lock schemes previously set. When the [DTV Lock] is set to [Unlock].

1. Display [Setup] menu.
2. Use $\wedge/\vee/\langle/\rangle$ to select [LOCK] and press ENTER (⊙).
3. Use \wedge/\vee to select [DTV Lock] and press ENTER (⊙).
4. Input the password using numerical buttons. If you have not set your password yet, input "1111" and press ENTER (⊙).
5. Use \wedge/\vee to select [Lock] and press ENTER (⊙) to activate the DTV Lock.

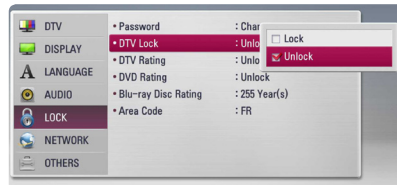

Adjusting DTV Rating

Viewing of some digital TV programmes can be limited according to the age limit you set.

1. Display [Setup] menu.
2. Use \wedge / \vee to select [LOCK] and press ENTER (⊙).
3. Use \wedge / \vee to select [DTV Rating] and press ENTER (⊙).
4. Input the password using numerical buttons.
If you have not set your password yet, input and press ENTER (⊙).

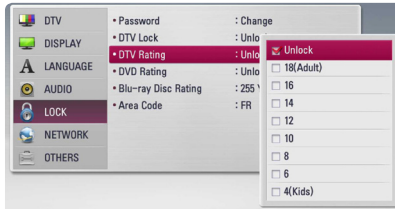

5. Use \wedge / \vee to set the limitation level and press ENTER (⊙).

Unlock

You can view all programs.

4 (Kids) - 18 (Adult)

Rating [4 (Kids)] has the most restrictions and [18 (Adult)] is the least restrictive.

Setting the antenna power

If you are using indoor antenna with a signal amplifier rated at DC 5V, 100mA, the recorder can supply power through ANTENNA IN jack.

1. Display [Setup] menu.
2. Use $\wedge / \vee / < / >$ to select [Antenna 5V] and press ENTER (⊙).
3. Use \wedge / \vee to select [On], and press ENTER (⊙) to supply antenna power.

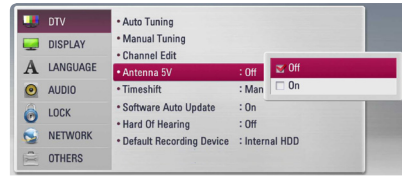

! Note

The [Antenna 5V] option must be set to [Off] when your indoor antenna is supplied the power from the mains. If you set the [Antenna 5V] option to [On] for the indoor antenna which is supplied power from the mains, it may cause serious defect to this unit.

Setting the Timeshift

You can set the Time Shift function automatically without pressing TIME SHIFT button. The timeshift will start after Digital TV tuner mode is started.

1. Display [Setup] menu.
2. Use \wedge / \vee to select [DTV], and press ENTER (⊙).
3. Use \wedge / \vee to select [Timeshift] and press ENTER (⊙).

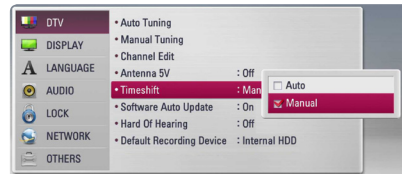

4. Use \wedge / \vee to select [Auto] or [Manual] to apply timeshift.

[DTV] Menu

Auto Tuning

This option scans a programme and sets the available programmes. Refer to page 26 for more information.

Manual Tuning

Scans digital TV or radio programmes and adds the found programmes to the programme list. Refer to page 26 for more information

Channel Edit

This option allows you to edit the TV or Radio programmes. Refer to page 27 for more information.

Antenna 5V

If you are using an indoor antenna, use one with a signal amplifier rated at DC 5V, 100mA and set this option to [On]. Refer to page 28 for more information.

Timeshift

Set this option to [Auto] to use the Time Shift function automatically without pressing TIME SHIFT button. The timeshift will start after TV viewing is started. Refer to page 28 for more information.

Software Auto Update

If you set this option to [On], the unit updates the latest software automatically through the built-in digital tuner. If the software update is available from the broadcaster.

Hard Of Hearing

Hard of hearing for users who are hearing impaired. If you set [On] and there is hard of hearing subtitle, You can see the subtitle on screen.

Default Recording Device

This option sets the storage where your TV recording will be stored. Select an option between [USB HDD] or [Internal HDD].

! Note

- Even though [USB HDD] is selected TV recording will be stored on internal HDD, if there is not proper external storage.
- Additionally default Rec.List storage is also applied by this menu option, so if you want to enter alternate Rec.List storage for selected option, then you can do it by entering [HOME] -> [Movie] device menu.

[DISPLAY] Menu

TV Aspect Ratio

Select a TV aspect ratio option according to your TV type.

[4:3 Letter Box]

Select when a standard 4:3 TV is connected. Displays theatrical images with masking bars above and below the picture.

[4:3 Pan Scan]

Select when a standard 4:3 TV is connected. Displays pictures cropped to fill your TV screen. Both sides of the picture are cut off.

[16:9 Original]

Select when a 16:9 wide TV is connected. The 4:3 picture is displayed with an original 4:3 aspect ratio, with black bars appearing at the left and right sides.

[16:9 Full]

Select when a 16:9 wide TV is connected. The 4:3 picture is adjusted horizontally (in a linear proportion) to fill the entire screen.

! Note

You cannot select [4:3 Letter Box] and [4:3 Pan Scan] option when the resolution is set to higher than 720p.

Resolution

Set the output resolution of the HDMI video signal. Refer to page 16 and 88 for details about the resolution setting.

[Auto]

If the HDMI OUT jack is connected to TVs providing display information (EDID), this automatically selects the resolution best suited to the connected TV.

[1080p]

Outputs 1080 lines of progressive video.

[1080i]

Outputs 1080 lines of interlaced video.

[720p]

Outputs 720 lines of progressive video.

[576p]

Outputs 576 lines of progressive video.

[576i]

Outputs 576 lines of interlaced video.

1080p Display Mode

When the resolution is set to 1080p, select [24 Hz] for smooth presentation of film material (1080p/24 Hz) with a HDMI-equipped display compatible with 1080p/24 Hz input.

! Note

- When you select [24 Hz], you may experience some picture disturbance when the video switches video and film material. In this case, select [50 Hz].
- Even when [1080p Display Mode] is set to [24 Hz], if your TV is not compatible with 1080p/24 Hz, the actual frame frequency of the video output will be 50 Hz or 60 Hz to match the video source format.

HDMI Color Setting

Select the type of output from the HDMI OUT jack. For this setting, please refer to the manuals of your display device.

[YCbCr]

Select when connecting to a HDMI display device.

[RGB]

Select when connecting to a DVI display device.

3D Mode

Select the type of output mode for Blu-ray 3D disc playback. Refer to page 49 for more information about Blu-ray 3D disc.

[Off]

Blu-ray 3D disc playback will output as 2D mode like a normal BD-ROM disc playback.

[On]

Blu-ray 3D disc playback will output as 3D mode.

Home Menu Guide

This function allows you to display or delete the guide bubble on the Home Menu. Set this option to [On] for displaying guide.

[LANGUAGE] Menu

Display Menu

Select a language for the [Setup] menu and on-screen display.

Disc Menu/Disc Audio/Disc Subtitle

Select the language you prefer for the audio track (disc audio), subtitles, and the disc menu.

[Original]

Refers to the original language in which the disc was recorded.

[Other]

Press ENTER (⏻) to select another language. Use number buttons then press ENTER (⏻) to enter the corresponding 4-digit number according to the language code list on page 79.

[Off] (Disc Subtitle only)

Turn off Subtitle.

! Note

Depending on the disc, your language setting may not work.

DTV Audio

Digital channels sometimes provide multiple audio tracks, often in a different language or format (Dolby Digital, Dolby Digital+, AVC, Mpeg, etc.). You can set a default audio language with this setting. If provided by the broadcaster, you can also select a different audio language while viewing TV by pressing AUDIO repeatedly. (See "Selecting DTV audio language" on page 39.)

DTV Subtitle

Digital channels sometimes provide subtitles, often in a different language. You can set a preferred subtitle language with this setting, if DTV subtitles are provided by the broadcaster. Press SUBTITLE repeatedly to select a subtitle language while viewing digital TV. (See "Selecting DTV subtitle language" on page 39.)

[AUDIO] Menu

Each disc has a variety of audio output options. Set the player's Audio options according to the type of audio system you use.

! Note

Since many factors affect the type of audio output, see "Audio Output Specifications" on pages 86-87 for details.

HDMI / Digital Output

Select the output sound format when a device equipped with a HDMI or Digital Audio input jack is connected to the HDMI OUT or OPTICAL (DIGITAL AUDIO OUT) jack on this player.

[PCM Stereo]

Select if you connect this unit's HDMI OUT or OPTICAL (DIGITAL AUDIO OUT) jack to a device with two-channel digital stereo decoder.

[PCM Multi-Ch] (HDMI only)

Select if you connect this unit's HDMI OUT jack to a device with multi-channel digital decoder.

[DTS Re-Encode]

Select if you connect this unit's HDMI OUT or OPTICAL (DIGITAL AUDIO OUT) jack to a device with a DTS decoder.

[Primary Pass-Thru]

Select if you connect this unit's OPTICAL (DIGITAL AUDIO OUT) and HDMI OUT jack to a device with LPCM, Dolby Digital, Dolby Digital Plus, Dolby TrueHD, DTS and DTS-HD decoder.

! Note

- When [HDMI] option is set to [PCM Multi-Ch], the audio may output as PCM Stereo if the PCM Multi-Ch information is not detected from HDMI device with EDID.
- If the [HDMI] or [Digital Output] option is set to [DTS re-encode], the DTS Re-encode audio is output for BD-ROM discs with secondary audio and the original audio is output for the other discs (like [Primary Pass-Thru]).

Sampling Freq. (Digital Audio Output)

[192 kHz]

Select this if your A/V Receiver or Amplifier is capable of handling 192 kHz signals.

[96 kHz]

Select this if your A/V Receiver or Amplifier is not capable of handling 192 kHz signals. When this choice is made, this unit automatically converts any 192 kHz signals to 96 kHz so your system can decode them.

[48 kHz]

Select this if your A/V Receiver or Amplifier is not capable of handling 192 kHz and 96 kHz signal. When this choice is made, this unit automatically converts any 192 kHz and 96 kHz signals to 48 kHz so your system can decode them.

Check the documentation for your A/V Receiver or Amplifier to verify its capabilities.

DRC (Dynamic Range Control)

This function allows you to listen to a movie at a lower volume without losing clarity of sound.

[Off]

Turns off this function.

[On]

Compress the dynamic range of the Dolby Digital, Dolby Digital Plus or Dolby TrueHD audio output.

[Auto]

The dynamic range of the Dolby TrueHD audio output is specified by itself. And the dynamic range of the Dolby Digital and Dolby Digital Plus are operated as same as the [On] mode.

! Note

The DRC setting can be changed only when a disc is not inserted or the unit is in complete stop mode.

DTS Neo:6

If the player is connected to the multi-channel Audio Receiver by HDMI connection, set this option to enjoy the multi-channel surround sound with the 2-channel audio source.

[Off]

Outputs the stereo sound via front speakers.

[Music]

Outputs the multi-channel sounds that are optimized for listening to music.

[Cinema]

Outputs the multi-channel sounds that are optimized for watching movie.

! Note

- This function is not available on an on-line service.
- Only the audio source with less than 48 kHz sampling frequency is available for this function.
- This function is available only when [HDMI] option is set to [PCM Multi-Ch].

S/PDIF

This function delays time of audio output as long as you want. Please select audio output time within [0 ms], [50 ms], [100 ms], [150 ms], [200 ms] or [250 ms].

[LOCK] Menu

To access any features in the [LOCK] settings, you must enter the 4-digit security code you have created.

If you have not entered a password yet, you are prompted to do so. Enter a 4-digit password twice, and press ENTER (⏻) to create a new password.

Password

You can create, or change the password.

[None]

Enter a 4-digit password twice, and press ENTER (⏻) to create a new password.

[Change]

Enter the current password and press ENTER (⏻). Enter a 4-digit password twice, and press ENTER (⏻) to create a new password.

If you forget your password

If you forget your password, you can clear it using the following steps:

1. Remove any disc that might be in the player.
2. Select [Password] option in the [Setup] menu.
3. Use Number buttons to enter "210499". The password is cleared.

! Note

If you make a mistake before pressing ENTER (⏻), press CLEAR. Then input the correct password.

DTV Lock

Allows you to set up specific programs and through blocking schemes. Also allows you to activate or disable all of the lock schemes previously set up. A password is required to gain access to the lock menu options. When the DTV Lock is set to [unlock]. (See "Setting the DTV Lock" on page 27.)

DTV Rating

You can set the rating to block out all the programs with rating above a specified level. (See "Adjusting DTV Rating" on pages 28.)

DVD Rating

Blocks playback of rated DVD based on their content. (Not all discs are rated.)

[Rating 1-8]

Rating one (1) has the most restrictions and rating eight (8) is the least restrictive.

[Unlock]

If you select [Unlock], parental control is not active and the disc plays in full.

Blu-ray Disc Rating

Sets an age limit for BD-ROM playback. Use number buttons to input an age limit for BD-ROM viewing.

[255]

All BD-ROM can be played.

[0-254]

Prohibits play of BD-ROM with corresponding ratings recorded on them.



Note

The [BD rating] will be applied only for the Blu-ray disc that containing the Advanced Rating Control.

Area Code

Enter the code of the area whose standards were used to rate the DVD video disc, based on the list on page 78.

[NETWORK] Menu

The [NETWORK] settings are needed to use the software update, BD-Live and online content services.

Connection Setting

If your home network environment is ready to be connected to the player, the player needs to be set to the wired or wireless network connection for network communication. (See "Connecting to your Home Network" on pages 18-22.)

Connection Status

If you want to check the network status on this player, select the [Connection Status] option and press ENTER (⊙) to check whether a connection to the network and the internet has been established.

Media File Sharing

If you want to share files in the internal hard disk drive to your PC or DLNA client device on your home network, set this option to [On].

[Media Share (DLNA) Allowance]

You can allow or deny DLNA devices to access share files. Select a device from the device list, and use \wedge / \vee / \lt / \gt to select [Allow] or [Deny] to control the access.



Note

- For the better performance, less than 3 client devices for simultaneous access to this player is highly recommended.
- Playback performance from your client device may be affected by the network condition and file specifications.
- Wireless network connection may result in improper access speed by interference from household devices that are using radio frequencies.

Device Name

You can make a network name using virtual keyboard. This player will be recognised by the name you are entering on your home network.

Wi-Fi Direct

This player is a Wi-Fi Direct™ certified device. Wi-Fi Direct™ is the technology that devices use to connect each other without connecting to an Access point or a router. Set this option to [On] for activating the Wi-Fi Direct™ mode. Refer to pages 60-62 for the device connection.

BD-LIVE connection

You can restrict Internet access when BD-LIVE functions are used.

[Permitted]

Internet access is permitted for all BD-LIVE contents.

[Partially permitted]

Internet access is permitted only for BD-LIVE contents which have content owner certificates. Internet access and AAC Online functions are prohibited for all BD-LIVE contents without a certificate.

[Prohibited]

Internet access is prohibited for all BD-LIVE contents.

Premium/LG Apps

[Country Setting]

Select your area for displaying proper services and contents on the [Premium] and [LG Apps] feature.

[ID Management]

Displays the [ID Management] menu. You can manage IDs that ever logged-in on this unit.

[Registration Code]

Display the unique code of this player for servicing [Premium] and [LG Apps] feature.

[OTHERS] Menu

Time Setting

The clock must be set in order to use timer recording.

[Auto]

Select a programme that broadcasts a clock signal and the clock will be set automatically. If the time that has been automatically set is not correct when compared your local time, you can set additional time option.

[Manual]

If there is no channel that broadcasts a clock signal in your area, you can set the time and date manually. Use </> to select each field, and input correct time and date using ^ / v , and press ENTER (⊙).

Blu-ray Storage Select

This player can store some BD-ROM disc related information, including downloaded on-line content such as movie trailers and special features into the internal hard disk drive or an USB device.

[Built-In Storage]

Store the downloaded Blu-ray disc content on the internal hard disk drive.

[USB Storage]

Store the downloaded Blu-ray disc content on the connected USB device.

Blu-ray Storage Clear

Removes the BD contents from the built-in storage or the connected USB storage.

[Built-In Storage]

Delete all the downloaded contents from the built-in storage.

[USB Storage]

Delete all the downloaded contents from the connected USB storage.

! Note

If you select USB Storage, playback, copying and recording on the USB device is disabled.

DivX® VOD

ABOUT DIVX VIDEO: DivX® is a digital video format created by DivX, LCC, a subsidiary of Rovi Corporation. This is an official DivX Certified® device that plays DivX video. Visit divx.com for more information and software tools to convert your files into DivX videos.

ABOUT DIVX VIDEO-ON-DEMAND: This DivX Certified® device must be registered in order to play purchased DivX Video-on-Demand (VOD) movies. To obtain your registration code, locate the DivX VOD section in your device setup menu. Go to vod.divx.com for more information on how to complete your registration.

[Register]

Displays the registration code of your player.

[Deregister]

Deactivate your player and display the deactivation code.



Note

All the downloaded videos from DivX VOD with this player's registration code can only be played back on this unit.

Network Play

This function allows you to control the playback of media streamed from DLNA media server by a DLNA certified smartphone. Most DLNA certified smartphone has a function to control the playback media on your home network. Set this option to [On] for allowing your smartphone to control this unit. Refer to instructions of your DLNA certified smartphone or the application for more detailed information.

Initialize

[Factory Set]

You can reset the recorder to all its factory settings. Some options cannot be reset (Rating and Password). The [Factory Set] menu appears on the screen after the factory settings.



Note

- If you reset the unit to its original factory settings using [Factory Set] option, you have to set the network settings activation again.
- The [Initialization] option is not available while recording or [Lock] in the [Setup] menu is set to [On].
- If you select [Factory Set] in the Setup menu, All the channels will be deleted.

[Internal HDD Format]

Everything recorded on the HDD will be erased.

1. Press HOME.
2. Use $\wedge / \vee / \lt / \gt$ to select [Setup] in the [Home] menu, and press ENTER (⊙).
3. Use \wedge / \vee to select [OTHERS] option from the [Setup] menu, and press ENTER (⊙).
4. Use \wedge / \vee to select [Initialize], and press ENTER (⊙) to display the sub-options.
5. Use \wedge / \vee to select [Internal HDD Format], and press ENTER (⊙). Select [No] and press ENTER to cancel.
6. Use \lt / \gt to select [Yes], and press ENTER (⊙) to start the HDD format. Select [OK] and press ENTER (⊙) to return to the previous step.

Software

[Information]

Displays the current software version.

[Update]

You can update the software by connecting the unit directly to the software update server (see pages 82-83).

Disclaimer Notice

Press ENTER (⊙) to view the notice of Network Service Disclaimer.

Auto Power Off

The screen saver appears when you leave the player in Stop mode for about five minutes. If you set this option to [On], the unit automatically turns itself off after the Screen Saver is displayed for 25 minutes. Set this option to [Off] to leave the screen saver until the unit is operated by the user.

Using the Digital TV functions

You can watch and record the digital TV programmes or playback the recorded TV programmes you want to watch using this unit.

Viewing the Digital TV

Viewing the Digital TV broadcasting on the TV screen.

! Note

- DTV antenna connection is required. (page 14)
- DTV settings such as [Auto Tuning] in the [Setup] menu may be required. (page 26)

1. Press **⏻** (POWER) to turn on the recorder.
2. Use **▲/▼/◀/▶** to select [DTV] on the HOME menu and press **ENTER** (⊙).



Changing Digital TV programmes

Generally, press CH (**▲/▼**) to select the programme position, or entering a programme number using numerical buttons. If you want to change the programme on the channel list, follow the instruction as below.

1. While watching DTV, press CH LIST.

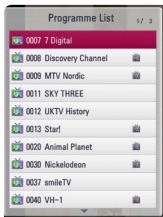

2. Use **▲/▼** to select a desired programme, and press **ENTER** (⊙).

Press red (**R**) coloured button to sort the programmes into alphabetical order. Press green (**G**) coloured button to sort the programmes into FTA - CAS Press yellow (**Y**) coloured button to sort the programmes into number order.

3. Press **BACK** (⏪) to exit the channel list.

Setting favourite programmes

You can set the storage location where you want to store the DTV recordings.

1. While watching DTV, press CH LIST.
2. Use **▲/▼** to select a programme you want to add on the Favourite List.
3. Press blue (**B**) coloured button to display [Select Favorite Group] menu.
4. Use **▲/▼** to select a group and press **ENTER** (⊙) to add the programme on the selected group.



5. On the channel List menu, use **◀/▶** to move to the Favorite List menu.

The **F** mark appears for the favourite programmes on the Favorite List.

To cancel the favourite programmes from the Favorite List, select a programme with **F** mark, and press blue coloured (**B**) button.

Viewing the programme information

You can view a description of the programme being broadcast.



1. While watching DTV, press TITLE/POPOP to display the programme information.
2. Press TITLE/POPOP (or BACK or EXIT) again to close the programme information.

Note

This function informs you of related broadcasting information on current channel.

Selecting DTV audio language

Some digital programmes may broadcast several audio languages or encoding methods. You can select an audio languages or an encoding method when it is available.

1. While watching DTV, press INFO/MENU (□).



2. Use </> to select an audio language or an encoding method, and press INFO/MENU (□).

Selecting DTV subtitle language

Some digital programmes may broadcast several subtitle languages. You can select a subtitle language when it is available.

1. While watching DTV, press SUBTITLE.



2. Use </> to select a subtitle language, and press ENTER (⊙).

Note

You can find a programme that supports subtitle language on the programme information. For the programmes with subtitle, SUB icon appears on the programme information.

Programme Guide (Digital program only)

The Program Guide contains schedule and program information for digital programs. They also provide local over-the-air programs information including conventional digital programs. Use the Program Guide to find programs easily and conveniently and to view schedule and descriptive program information for the programs.

To Display the Program Guide

Press the GUIDE button on your remote control.

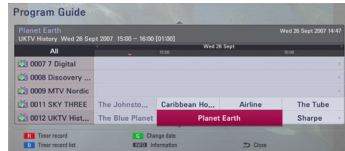

To Exit the Program Guide

Press the BACK (⏪) button to return to the last program you tuned to.

To navigate through programs on the Guides

Use ^ / v / < / > on your remote control to navigate the guide screen.

You can move faster through programs by scrolling page-by-page with the CH ^ / v buttons on the remote control. Each button stroke scrolls one page up or down.

To tune to another current channel

Use ^ / v / < / > to select a current channel then press ENTER (⊙). You can watch the channel.

To display the Full Information window

You can view the detail information for the highlighted program. Press INFO/MENU (□) to display detail information window. To exit the detail information window, press ENTER (⊙) again.

To change date

When the Program Guide with 8 days is displayed, you can also change the date of the Program Guide by pressing the green colour button then use </> to select a date.

After setting favorite channels from the CH list, you can use the yellow button to toggle between [All] and [Favorite] channel list.

Timer Recording with Program Guide

You can set a timer record using program guide with 8 days.

1. Display Program Guide with 8 days.
2. Select a program then press **(R)** color button. The options for timer recording will appear.

[Simple] – Records only the selected program.

[Series] – Records the programs in a series.

[Split] – Records the subsequent parts of events which are split.

[Recommend] – Records the program is recommended by broadcaster as a link for current series.

! Note

- The [Series], [Split] and [Recommend] options cannot be used when the broadcaster does not include series information with the program data.
- Whether or not a program is in a series is determined by the broadcaster.

3. Select an option then press ENTER (⊙). The red timer icon will be displayed and the program will be memorized by the recorder. You can check the programming on the Timer Record List menu (see pages. 43-44).
4. To release the timer recording, select the program, Select the option again then press ENTER (⊙). The red timer icon disappears

Using the MHEG (Viewing MHEG)

Many digital TV channels broadcast information via their text service. This digital service includes high quality digital text and graphics along with advanced navigation options. Additionally, this recorder has access to dedicated text channels transmitted by the broadcasters. The appearance, content and navigation methods of all digital text services are decided by the broadcaster.

1. Press TEXT or Red color button to bring up the text and graphics menu for the current channel.
2. Use **^/v/</>** to navigate through the menu.
3. Use ENTER (⊙) to select an item. Additionally you now have the four colour keys (**R, G, Y** and **B**) to navigate through the content of the page. How they will be used will vary for different stations; read their meaning from the bottom line (usually) or wherever they appear on the screen and use them as required.
4. Press RETURN/TEXT to leave the MHEG.

! Note

When you using timeshift or recording, MHEG service cannot be disable.

What is FREEVIEW PLAYBACK?

FREEVIEW PLAYBACK™ gives you over 40 FREEVIEW™ channels that you can pause, record and rewind for no monthly subscription.

To check you're in a FREEVIEW coverage area, text your postcode to 83331

* or visit www.freeview.co.uk * Costs no more than a normal text. The FREEVIEW service is subject to coverage.

The FREEVIEW service is subject to coverage. An aerial upgrade may be required. The FREEVIEW PLAYBACK word and logo are trade marks of DTV Services Ltd and are used under licence. © DTV Services Ltd 2006.

Using the timeshift function manually

You can pause a Live TV broadcast, then continue watching the programme at a later time. This is useful when you receive an unexpected call or visitor while watching TV.

The following are operating steps when the [Timeshift] option is set to [Manual].

1. Press TIME SHIFT while watching a TV broadcast. The recorder starts recording the current TV programme to the HDD.
2. Press **II** to pause the programme you're watching the just now.
3. Press **▶** to resume watching the programme.



Press TIME SHIFT to display the progress of timeshift.

Press **◀◀/▶▶** to move the starting point or the ending point of timeshift.

Press **◀◀/▶▶** to playback of timeshift fast forward or fast reverse.

4. Press **■** to cancel the timeshift. Timeshift cannot be saved as a recorded title.

Using the timeshift function automatically

If you set the timeshift option to [Auto], live TV broadcast will automatically be recorded to the HDD without pressing the TIME SHIFT button. The timeshift will start automatically when the Digital TV tuner mode is started.

Refer to "Setting the Timeshift" on page 28 to set the [Timeshift] option.

1. Press **⏻** (POWER) to turn on the unit.
2. Use **▲/▼/◀/▶** to select [DTV] and press ENTER (⊙). The timeshift function will automatically start.

Press **◀◀/▶▶** to move the starting point or the ending point of timeshift.

Press **◀◀/▶▶** to playback of timeshift fast forward or fast reverse.

3. Press HOME to exit from the DTV viewing.
4. Press **■**, it's not turning off the timeshift function but going back to the DTV in realtime.

! Note

- Without changing a channel, the timeshift function will go on.
- When you exit from the DTV mode, timeshift function automatically will be stopped. Ex) Home menu, Power off, Record etc.
- If you change the channel during the timeshift function, the unit will switch to Live TV automatically.
- If the timeshift data exceeds the capacity, the data will be deleted automatically from the oldest one.
- Timeshift doesn't support Audio only channel.
- Timeshift cannot start clock is not set correctly.

Recording TV programmes

You can record Digital TV programmes and store them on the HDD.

For a record on external USB HDD, connect external USB HDD to USB port on rear panel. The external USB HDD for record has to be formatted in NTFS.

It is not available to record by connecting USB port on the front panel of the unit to USB HDD.

Normal Recording

1. Use CH (▲/▼) to select a programme you want to record.
2. Press ● REC to start recording.
Press || to pause recording, press || again to resume recording.

! Note

It the TV screen turns black with stop mark that caused by no signal, scramble, rating lock and any other reasons, then recording is not available.

Dual Programme Recording

You can record two Digital TV programme at the same time.

1. Use CH (▲/▼) to select a programme you want to record.
2. Press ● REC to start recording.
3. Use CH (▲/▼) to select another programme you want to record.
4. Press ● REC to start recording.

While recording two programmes simultaneously, you can only watch the programmes being recorded.

! Note

If the timer recording is performed during instant dual recording, you can select one of the two recordings. Because the recording, which is being done, is given priority, the timer recording can be canceled.

Stop Recording

You can stop recording instantly.

1. Press ■ then stop dialogue is displayed.
2. Use ▲/▼ to select a recording you want to stop.
3. Press ENTER (⊙) to stop recording.

Timer Recording (Manual)

You can set the timer for a total of 32 programmes, up to 22-28 days in advance.

1. While watching TV, press **TIMER REC**.



2. Use **^**/**v**/**</>** to select the date to record, and press **ENTER** (⊙).



3. Select an item using **</>** and adjust it using **^**/**v**. You can use numbered buttons to change the setting. The adjustable items are listed below.

Start time	Sets the start time.
End time	Sets the end time.
Channel	Sets the programme position. (If you want to display more channels, press CH LIST)
Repeat	Choose a desired repeat mode. (Once, Daily, Weekly or Mon-Fri)

! Note

- The timer recording can be set from 3 minutes after the current time.
- Timer recording is not available on a USB device.
- The timer recording is set up to 2 channels at the same time.

4. Press **ENTER** (⊙).
5. Select **[OK]** then press **ENTER** (⊙).

If you input the wrong information, an error message will appear and the timer recording cannot be made.

Timer Recording (EPG)

You can also set the timer based on the information provided by the EPG.

1. While watching TV, press **GUIDE**.

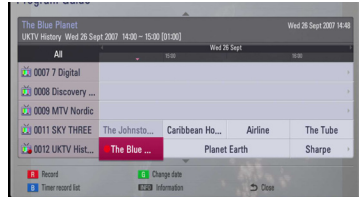

2. Use **</>** to select date field, and select the date of recording schedule using **^**/**v**.
3. Use **</>** to select programme field, and set the programme using **^**/**v**.
4. Use **</>** to select the programme list, and select a programme you want to record using **^**/**v**.
5. Select a program then press **(R)** color button. The options for timer recording will appear.

[Simple] – Records only the selected program.

[Series] – Records the programs in a series.

[Split] – Records the subsequent parts of events which are split.

[Recommend] – Records the program is recommended by broadcaster as a link for current series.

6. Select an option then press **ENTER** (⊙). For the successfully scheduled programme, a red bullet mark appears. A red bullet mark may not appear for unavailable programme to record.
7. Press **BACK** (⏪) to return to the TV viewing.
8. Press **TIMER REC**, and check whether the schedule is registered properly or not.



Canceling a timer recording

You can cancel a timer recording before the timer recording actually starts.

1. While watching TV, press **TIMER REC.**
2. Press the red **(R)** coloured button.
3. Use **</> ^ / V** to select a schedule you want to cancel.
4. Use **^ / V** to select [Timer Record List], and press the green **(G)** coloured button.



Select [No] and press **ENTER (⊙)** to cancel.

Select [Yes] and press **ENTER (⊙)** to delete selected schedules (selected recording).

Editing a timer recording

You can edit a pre-scheduled timer recording before the timer recording actually starts.

1. While watching TV, press **TIMER REC.**
2. Press the red **(R)** coloured button.
3. Press **ENTER (⊙)** to display the [Record setting] menu.

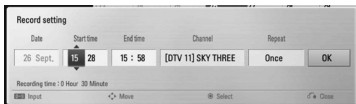

4. Follow the steps 3-5 from "Timer Recording (Manual)" on page 43 to complete the editing.

Instant Timer Recording

You can set the recording time instantly to stop the recording automatically.

1. Use **CH (^ / V)** to select a programme you want to record.
2. Press **● REC.** to start recording.
3. While recording, press **</>** repeatedly to set the recording duration on recording OSD to confirm modification.
4. Press **ENTER (⊙)**.

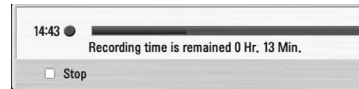

5. Press **■** to stop recording.

! Note

- The default recording time is 3hours (MAX=6hours). Depending on the remaining capacity of HDD, the recording time is somewhat flexible.
- If the unit cannot catch the signal, the recording will be pause, actual recording time can be less than the time set on timer.
- You cannot record radio or blocked channels.
- The quality of recording can be different on the status of the broadcast signal.
- During the recording, turning off by force can cause a serious problem on hard disk drive.
- Recording can be restarted when contents status is changed and it'll separate recording title into two individual title consequently.

General Playback

Playing Discs

1. Press ▲ (OPEN/CLOSE), and place a disc on the disc tray.
2. Press ▲ (OPEN/CLOSE) to close the disc tray.
For most Audio CD, BD-ROM and DVD-ROM discs, playback starts automatically.
3. Press HOME (🏠).

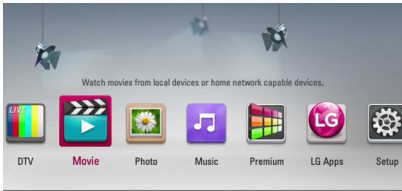

4. Select [Movie], [Photo] or [Music] using </>, and press ENTER (⊙).
5. Select the [Disc] using ▲/▼, and press ENTER (⊙).



While navigating [Movie], [Photo] or [Music] menu, press green (G) colored button to change the device. (DISC, USB or HDD)

6. Select a file using ▲/▼/</>, and press ► (PLAY) or ENTER (⊙) to play the file.

! Note

- Playback functions described in this manual are not always available in every files and media. Some functions can be restricted depending on many factors.
- Depending on the BD-ROM titles, a USB device connection may be needed for proper playback.

To stop playback

Press ■ (STOP) during playback.

To pause playback

Press ⏸ (PAUSE) during playback.
Press ▶ (PLAY) to resume playback.

To play frame-by-frame

Press ⏸ (PAUSE) while movie playback.
Press ⏸ (PAUSE) repeatedly to playback Frame-by-Frame.

To scan forward or backward

Press ⏪ or ⏩ to play fast forward or fast reverse during playback.

You can change the various playback speeds by pressing ⏪ or ⏩ repeatedly.

To slow down the playing speed

While the playback is paused, press ⏩ repeatedly to play various speeds of slow motion.

To skip to the next/previous chapter/track/file

During playback, press ⏮ or ⏭ to go to the next chapter/track/file or to return to the beginning of the current chapter/track/file.

Press ⏮ twice briefly to step back to the previous chapter/track/file.

In the file list menu of a server, there may have many types of contents in a folder together. In this case, press ⏮ or ⏭ to go to the previous or next content with same type.

Using the disc menu

BD DVD AVCHD

To display the disc menu

The menu screen may be displayed first after loading a disc which contains a menu. If you want to display the disc menu during playback, press DISC MENU.

Use \wedge / \vee / \lt / \gt buttons to navigate through menu items.

To display the Pop-up menu

Some BD-ROM discs contain a Pop-up menu that appears during playback.

Press TITLE/POPUK during playback, and use \wedge / \vee / \lt / \gt buttons to navigate through menu items.

Resume playback

BD DVD AVCHD MOVIE MOVIE-N
ACD MUSIC MUSIC-N REC

This unit remembers the point where you pressed the ■ (STOP) depending on the disc. If "■" (Resume Stop) appears on the screen briefly, press ► (PLAY) to resume playback (from the scene point).

If you press ■ (STOP) twice or unload the disc, "■" (Complete Stop) appears on the screen. The unit will clear the stopped point.

Note

- The resume point may be cleared when a button is pressed (for example; ⏻ (POWER), ▲ (OPEN/CLOSE), etc).
- On BD-Video discs with BD-J, the resume playback function does not work.
- If you press ■ (STOP) once during BD-ROM interactive title playback, the unit will be in Complete Stop mode.

Playing the recorded titles

REC

1. While watching TV, press REC LIST to display the options menu or press REC LIST in Home menu.



2. Use \wedge / \vee / \lt / \gt to select recording title.
3. Press ► (PLAY) or ENTER (⊙) to play the recording title.

Note

- N Mark is displayed next to recorded files that have not been viewed yet.
- Pay channel title does not have thumbnail.

Searching the recorded titles

REC

You can search for videos by entering search words of up to 60 characters.

1. While watching TV, press REC LIST to display the options menu.
2. Press yellow (Y) colored button.
3. Use \wedge / \vee / \lt / \gt to select a character then press ENTER (⊙) to confirm your selection on the virtual keyboard.

To enter a letter with an accent mark, select the letter from extended character set.



[Clear] – Clear all entered characters.

[Space] – Inserts a space at the cursor position.

[<-] – Deletes the previous character at the cursor position.

[ABC / abc / # \$ % &] – Change the keyboard menu settings to capital letters, small letters or symbols.

Note

To enter a letter with an accent mark:

1. Select a letter using **^ / v / < / >** on the keyboard menu.
 2. Press **INFO/MENU** (**□**) to display the extended character set.
 3. character set. Use **< / >** to select a character then press **ENTER** (**⊙**).
4. When you finish entering the search words, Select **[OK]** and press **ENTER** (**⊙**) to display the related videos list.

Sorting the recorded titles

REC

1. While watching TV, press **REC LIST** to display the options menu.
2. Press blue (**B**) coloured button repeatedly to sorted by recorded time in recent order or title name in alphabetical order.

[ABC order] – by title name in alphabetical order.

[Recent order] – sorted by recorded date.

Playing content contained in the internal hard disk drive

1. Press **HOME** (**🏠**).

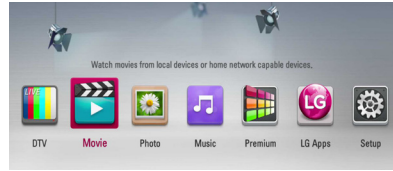

2. Select **[Movie]**, **[Photo]** or **[Music]** using **< / >**, and press **ENTER** (**⊙**).
3. Select the **[HDD]** option using **^ / v**, and press **ENTER** (**⊙**).

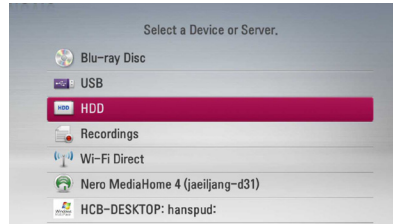

This step is needed only when a disc or a USB device is connected on this unit.

While navigating **[Movie]**, **[Photo]** or **[Music]** menu, press green (**G**) colored button to change the device. (**DISC**, **USB** or **HDD**)

4. Select a file using **< / >** **^ / v**, and press **PLAY** or **ENTER** (**⊙**) to play the file.

Note

- The file requirements are described on page 10.
- You can use various playback functions. Refer to pages 45-54.
- Recorded files are searchable only by searching on the **[REC. LIST]**.

Searching content in the hard disk drive by entering file name

If you are having difficulties finding content in the hard disk drive, you can search for the content by entering keyword with the virtual keyboard

1. On the [Movie], [Photo], [Music] or Home menu, press yellow (Y) coloured button to display the virtual keyboard.



2. Use </>^/∨ to select letters then press ENTER (⊙) to confirm your selection on the virtual keyboard.
3. When you finish entering the keyword, select [OK] and press ENTER (⊙) to display search result.

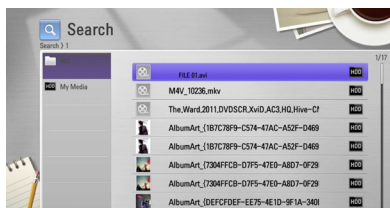

4. Press </> repeatedly until the search result is selected, and use ^/∨ to select a desired content.
5. Press ENTER (⊙) to play the content.

! Note

It will show search result will show Latest list of recorded files. If you don't enter stored recording list it will search recorded contents of default storage option.

Playing Blu-ray 3D disc

This player can play the Blu-ray 3D discs which contains separate views for the left and right eyes.

Preparation

In order to playback Blu-ray 3D title in stereoscopic 3D mode, you need to:

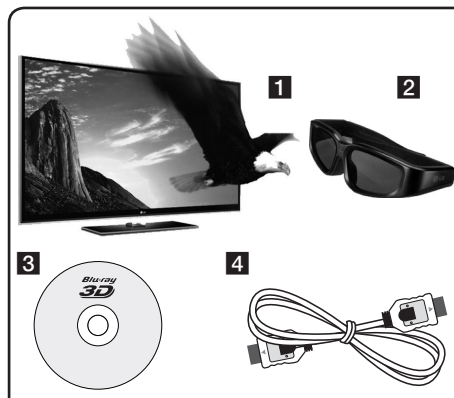

- 1 Check if your TV is 3D capable and has HDMI 1.4 input(s).
 - 2 Wear 3D glasses to enjoy the 3D experience if it is necessary.
If you want to purchase additional 3D-ready glasses, contact the dealer that you purchased the 3D-ready TV from.
 - 3 check whether the BD-ROM title is the Blu-ray 3D disc or not.
 - 4 connect an HDMI cable (version 1.3 or higher) between the player's HDMI output and TV's HDMI input.
1. Press HOME (🏠), and set the [3D Mode] option on the [Setup] menu to [On] (page 31).
 2. Insert a disc in the disc slot.

The playback starts automatically.



The 3D icon appears on the screen when 3D content is in playback.

3. Refer to the owner's manual of your 3D-ready TV for the further instruction.

You may need to adjust the display settings and focus on your TV's setting for the improved 3D effect.

Caution

- Watching a 3D content for a long period time may cause dizziness or tiredness.
- It is not recommended to watch a movie in 3D mode for infirm, child and pregnant woman.
- If you are experiencing headache, tiredness or dizziness while viewing contents in 3D, it is strongly recommended to stop the playback and rest until you feel normal.

3D available Blu-ray 3D Discs



The "Blu-ray 3D" logo labeled BD-ROM disc can be played on this player with 3D mode output. If your TV is not the Blu-ray 3D-ready TV*, 2D mode output is available.



3D ONLY

The "Blu-ray 3D ONLY" logo labeled BD-ROM disc can be played on this player with 3D mode output. The Blu-ray 3D ONLY disc playback is not available, if your TV or player are not the Blu-ray 3D-ready device.

* 3D-ready TV refers to TVs that are compliant with "HDMI 1.4 3D mandatory format" standard.

Note

The "Blu-ray 3D" and "Blu-ray 3D ONLY" may not be printed on your BD-ROM disc, even if the disc contains 3D contents.

Advanced Playback

Repeat Playback

BD	DVD	AVCHD	ACD	MUSIC
MUSIC-N				

During playback, press REPEAT (⏮️) repeatedly to select a desired repeat mode.

BDs/DVDs

- 🔁 **A-** – Selected portion will be repeated continually.
- 🔁 **Chapter** – The current chapter will be played back repeatedly.
- 🔁 **Title** – The current title will be played back repeatedly.

To return to normal playback, press REPEAT (⏮️) repeatedly to select [Off].

Audio CDs/Music files

- 🔁 **Track** – The current track or file will be played back repeatedly.
- 🔁 **All** – All the tracks or files will be played back repeatedly.
- 🔁 **X** – The tracks or files will be played back in random order.
- 🔁 **X All** – All the tracks or files will be played back repeatedly in random order.
- 🔁 **A-B** – Selected portion will be repeated continually. (Audio CD only)

To return to normal playback, press CLEAR.

Note

- If you press ⏮️ once during Repeat Chapter/Track playback, the repeat playback cancels.
- This function may not work on some disc or title.

Repeating a specific portion

BD **DVD** **AVCHD** **ACD**

This player can repeat a portion you have selected.

1. During playback, press REPEAT (↺↻) to select [A-] at the beginning of the portion you wish to repeat.
2. Press ENTER (⊙) at the end of the portion. Your selected portion will be repeated continually.
3. To return to normal playback, press REPEAT repeatedly to select [Off].

! Note

- You cannot select a portion less than 3 seconds.
- This function may not work on some disc or title.

Changing content list view

MOVIE **MOVIE-N** **MUSIC** **MUSIC-N** **PHOTO**
REC

On the [Movie], [Music] or [Photo] menu, you can change the content list view.

Method 1

Press red (R) coloured button repeatedly.

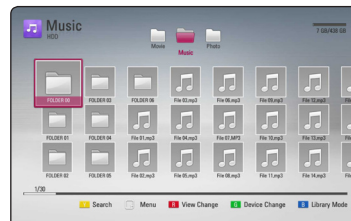
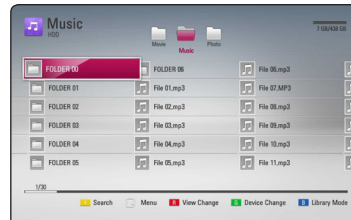
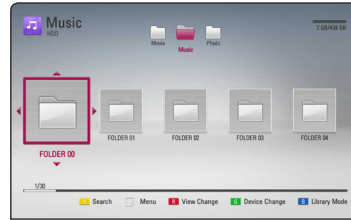

Method 2

1. On the content list, press INFO/MENU (ⓘ) to display the option menu.
2. Use ▲ / ▼ to select the [View Change] option.
3. Press ENTER (⊙) to change the content list view.

Viewing content information

MOVIE **MOVIE-N** **REC**

The player can display the content information.

1. Select a file using $\wedge/V/</>$.
2. Press INFO/MENU (I) to display the option menu.
3. Select the [Information] option using \wedge/V , and press ENTER (O).

The file information appears on the screen

During movie playback, you can display the file information by pressing TITLE/POPUP.

! Note

The information displayed on the screen may not be correct compared to the actual content information.

Last Scene Memory

BD **DVD**

This unit memorizes the last scene from the last disc that is viewed. The last scene remains in memory even if you remove the disc from the unit or switch off the unit. If you load a disc that has the scene memorized, the scene is automatically recalled.

! Note

- Last Scene Memory function for a previous disc is erased once a different disc is played.
- This function may not work depending on the disc.
- On BD-Video discs with BD-J, the last scene memory function does not work.
- This unit does not memorize settings of a disc if you switch off the unit before commencing to play it.

Selecting a subtitle file

MOVIE

If the subtitle file name is different from the movie file name, you need to select the subtitle file on the [Movie] menu before playing the movie.

1. Use $\wedge/V/</>$ to select the subtitle file you wish to play in the [Movie] menu.
2. Press ENTER (O).

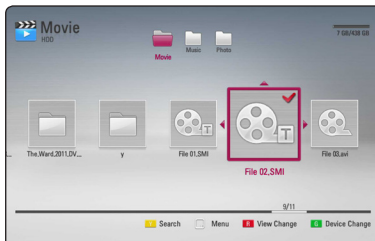

Press ENTER (O) again to deselect the subtitle file. Selected subtitle file will be displayed when you play the movie file.

! Note

This function is not available for playing file on a server via home network.

On-Screen display

You can display and adjust various information and settings concerning the content.

Displaying content information on-screen



1. During playback, press INFO/MENU (ⓘ) to show various playback information.



- 1 **Title** – current title number/total number of titles
- 2 **Chapter** – current chapter number/total number of chapters
- 3 **Time** – elapsed playing time/total playback time
- 4 **Audio** – selected audio language or channel
- 5 **Subtitle** – selected subtitle
- 6 **Angle** – selected angle/total number of angles
- 7 **TV Aspect Ratio** – selected TV aspect Ratio
- 8 **Picture Mode** – selected picture mode
- 9 **Movie Information** – Select this option and press ENTER (Ⓞ) to display movie information from Gracenote Media Database (Blu-ray Disc/DVD only).

2. Select an option using \wedge / \vee .
3. Use $< / >$ to adjust the selected option value.
4. Press BACK (⏪) to exit the On-Screen display.

! Note

- If no button is pressed for a few seconds, the on-screen display disappears.
- A title number cannot be selected on some discs.
- Available items may differ depending on discs or titles.
- If BD interactive title is playing back, some setting information is displayed on the screen but prohibited to be changed.
- To use the [Movie Information] option, the player must be connected to the broadband internet for accessing the Gracenote Media Database.
- If the information from the Gracenote Media Database is either not correct or does not exist, please contact www.gracenote.com for support.
- LG is a licensee of Gracenote technology and is not responsible or reliable for information from the Gracenote Media Database.
- The unit may not be able to display the music information depending on the network condition.

Playing from selected time

BD	DVD	AVCHD	MOVIE	MOVIE-N
REC				

1. Press INFO/MENU (□) during playback. The time search box shows the elapsed playing time.
2. Select the [Time] option and then input the required start time in hours, minutes, and seconds from left to right.

For example, to find a scene at 2 hours, 10 minutes, and 20 seconds, enter "21020".

Press </> to skip the playback 60 seconds forward or backward.

3. Press ENTER (⊙) to start playback from selected time.

! Note

- This function may not work on some disc or titles.
- This function may not work depending on the file type and ability of the DLNA server.
- This function is not accurate in recordings.

Hearing different audio

BD	DVD	AVCHD	MOVIE	MOVIE-N
REC				

1. During playback, press INFO/MENU (□) to display the On-Screen display.
2. Use ^/v to select the [Audio] option.
3. Use </> to select desired audio language, audio track or audio channel.

! Note

- Some discs allow you to change audio selections only via the disc menu. In this case, press TITLE/POPUP or DISC MENU button and choose the appropriate audio from the selections on the disc menu.
- Immediately after you have switched sound, there may be a temporary discrepancy between the display and actual sound.
- On BD-ROM disc, the multi audio format (5.1CH or 7.1CH) is displayed with [MultiCH] in the on-screen display.

Selecting a subtitle language

BD	DVD	AVCHD	MOVIE	MOVIE-N
REC				

1. During playback, press INFO/MENU (□) to display the On-Screen display.
2. Use ^/v to select the [Subtitle] option.
3. Use </> to select the desired subtitle language.
4. Press BACK (↩) to exit the On-Screen display.

! Note

Some discs allow you to change subtitle selections only via the disc menu. If this is the case, press TITLE/POPUP or DISC MENU button and choose the appropriate subtitle from the selections on the disc menu.

Watching from a different angle

BD DVD

If the disc contains scenes recorded at different camera angles, you can change to a different camera angle during playback.

1. During playback, press INFO/MENU (⏏) to display the On-Screen display.
2. Use \wedge / \vee to select the [Angle] option.
3. Use \lt / \gt to select the desired angle.
4. Press BACK (⏪) to exit the On-Screen display.

Changing the TV Aspect Ratio

BD AVCHD MOVIE MOVIE-N REC

You can change the TV aspect ratio setting during playback.

1. During playback, press INFO/MENU (⏏) to display the On-Screen display.
2. Use \wedge / \vee to select the [TV Aspect Ratio] option.
3. Use \lt / \gt to select desired option.
4. Press BACK (⏪) to exit the On-Screen display.

! Note

Even if you change the value of the [TV Aspect Ratio] option in On-Screen display, the [TV Aspect Ratio] option in the [Setup] menu is not changed.

Changing the Picture Mode

BD DVD AVCHD MOVIE MOVIE-N
REC

You can change the [Picture mode] option during playback.

1. During playback, press INFO/MENU (⏏) to display the On-Screen display.
2. Use \wedge / \vee to select the [Picture Mode] option.
3. Use \lt / \gt to select desired option.
4. Press BACK (⏪) to exit the On-Screen display.

Setting the [User setting] option

1. During playback, press INFO/MENU (⏏) to display the On-Screen display.
2. Use \wedge / \vee to select the [Picture Mode] option.
3. Use \lt / \gt to select the [User setting] option, and press ENTER (⏏).



4. Use $\wedge / \vee / \lt / \gt$ to adjust the [Picture Mode] options.

Select [Default] option then press ENTER (⏏) to reset the all video adjustments.

5. Use $\wedge / \vee / \lt / \gt$ to select the [Close] option, and press ENTER (⏏) to finish setting.

Copying

Copying file(s)/folder(s) to the internal hard disk drive

You can copy music, photo, video file(s)/folder(s) from disc/USB storage device to the internal hard disk drive.

1. Press HOME (🏠).

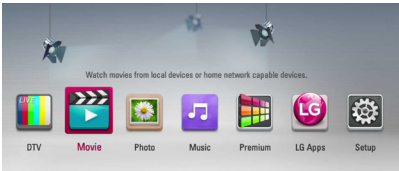

2. Select [Movie], [Photo] or [Music] using </>, and press ENTER (⊙).
3. Select the [Disc] or [USB] option using ^/v, and press ENTER (⊙).



4. Use ^/v/</> to select a directory that files or folders you want to copy are located.

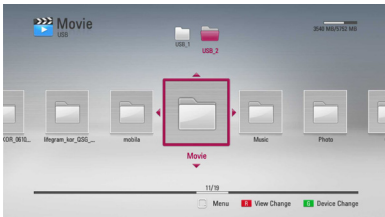

5. Press INFO/MENU (⏏) to display the option menu.
6. Use ^/v to select [Copy] option, and press ENTER (⊙) to display the [Copy] menu.

7. Use ^/v to select a file or a folder you wish to copy on the menu, and press ENTER (⊙).

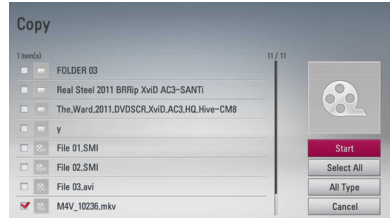

Repeat this step to select files and folders as many as you can.

	Select all the files and folders on the current directory.
	Shows all type of files on the screen. (Movie, Photo and Music)
	Cancel the copying and returns to the previous screen.

8. Use ^/v/</> to select [Start], and press ENTER (⊙).
9. Use ^/v/</> to select the destination folder to be copied.

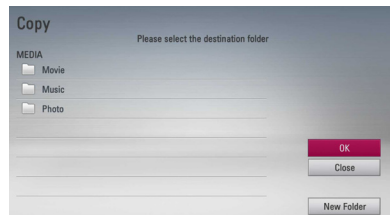

10. (Option)

If you want to create a new folder, use ^/v/</> to select [New Folder] and press ENTER (⊙).



Enter folder name using virtual keyboard, and press ENTER (⊙) while [OK] is selected.

11. Use $\wedge / \vee / < / >$ to select [OK], and press ENTER (⊙) to start copying.

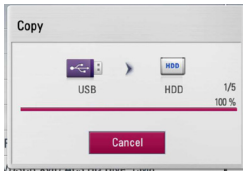

Note

Copying speed may vary depending on the file size, number of file.

Copying file(s)/folder(s) from the internal hard disk drive to a USB storage device

You can copy music, photo, video file(s)/folder(s) from the internal hard disk drive to a USB storage device.

1. Insert a USB device to the USB port until it fits into place.
2. Press HOME (🏠).

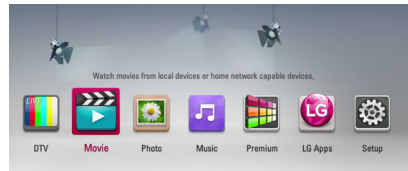

3. Select [Movie], [Photo] or [Music] using $< / >$, and press ENTER (⊙).
4. Select [HDD] using \wedge / \vee , and press ENTER (⊙).



5. Use $\wedge / \vee / < / >$ to select a directory that files or folders you want to copy are located.

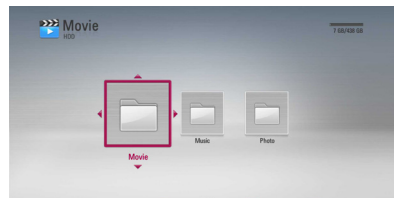

6. Press INFO/MENU (⏏) to display the option menu.
7. Use \wedge / \vee to select [Copy] option, and press ENTER (⊙) to display the [Copy] menu.

- Use \wedge/\vee to select a file or a folder you wish to copy on the menu, and press ENTER (⊙).

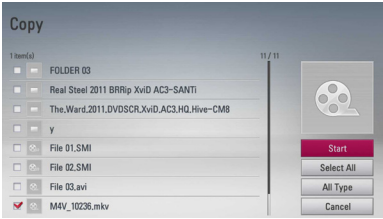

Repeat this step to select files and folders as many as you can.

	Select all the files and folders on the current directory.
	Shows all type of files on the screen. (Movie, Photo and Music)
	Cancels the copying and returns to the previous screen.

- Use $\wedge/\vee/\langle/\rangle$ to select [Start], and press ENTER (⊙).
- Use $\wedge/\vee/\langle/\rangle$ to select the destination folder to be copied.

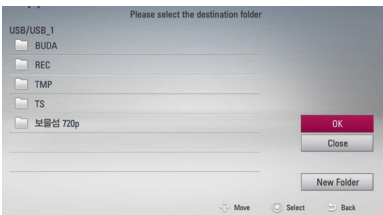

- (Option)

If you want to create a new folder, use $\wedge/\vee/\langle/\rangle$ to select [New Folder] and press ENTER (⊙).



Enter folder name using virtual keyboard, and press ENTER (⊙) while [OK] is selected.

- Use $\wedge/\vee/\langle/\rangle$ to select [OK], and press ENTER (⊙) to start copying.

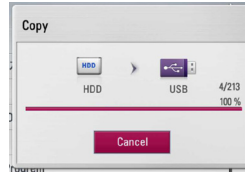

Note

- Copying speed may vary depending on the file size, number of files.
- It is unable to do copy during the recording.
- If a reserved recording is started during taking a copy, the recording is discontinued then a notification pops up.
- The name of copied files can be different from that of original files.
- It might not be copied if it is copy-protected contents.
- Successful copying contents also depend on USB storage's capability.

Deleting a file(s)/folder(s)

You can delete file(s)/folder(s) from the internal hard disk drive.

1. Use $\wedge/\vee/</>$ to select a directory that files or a folders you want to delete are located.
2. Press INFO/MENU (\square) to display the option menu.
3. Use \wedge/\vee to select [Delete] option, and press ENTER (\odot) to display the [Delete] menu.
4. Use \wedge/\vee to select a file or a folder you wish to copy on the menu, and press ENTER (\odot).

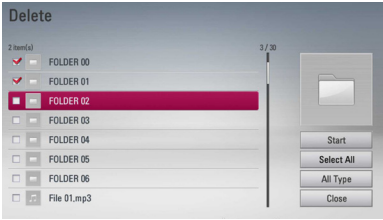

Repeat this step to select files and folders as many as you can.

Select All	Select all the files and folders on the current directory.
All Type	Shows all type of files on the screen. (Movie, Photo and Music)
Cancel	Cancel the copying and returns to the previous screen.

5. Use $\wedge/\vee/</>$ to select [Start], and press ENTER (\odot).
6. Use $</>$ to select [OK], and press ENTER (\odot) to delete the selected files and folders.

! Note

- If a reserved recording is started during taking a copy, the recording is discontinued then a notification pops up.
- It is unable to do delete during the recording.

Naming a file/folder

You can re-name a file or a folder in the internal hard disk drive.

1. Select a file or a folder contained in the internal hard disk drive.
2. Press INFO/MENU (\square) to display the option menu.
3. Use \wedge/\vee to select [Rename] option, and press ENTER (\odot) to display the virtual keyboard.



Enter a new name using virtual keyboard, and press ENTER (\odot) while [OK] is selected.

! Note

A just archived audio file(s) from an audio CD may be unable to be renamed for a while.

Enjoying BD-LIVE

This unit allows you to enjoy functions such as picture-in-picture, secondary audio and Virtual packages, etc., with BD-Video supporting BONUSVIEW (BD-ROM version 2 Profile 1 version 1.1/ Final Standard Profile). Secondary video and audio can be played from a disc compatible with the picture-in-picture function. For the playback method, refer to the instructions in the disc.

In addition to the BONUSVIEW function, BD-Video supporting BD-LIVE (BD-ROM version 2 Profile 2) that has a network extension function allows you to enjoy more functions such as downloading new movie trailers by connecting this unit to the internet.

1. Check the network connection and settings (pages 18-22).
2. Set the [Blu-ray Storage Select] setting in the [Setup] menu (page 35).

If the [Blu-ray Storage Select] option in the [Setup] menu is set to [USB Storage], a USB storage device connection is needed to download bonus content.

3. Press HOME (🏠), and set the [BD-LIVE connection] option on the [Setup] menu (page 35).

Depending on the disc, the BD-LIVE function may not operate if [BD-LIVE connection] option is set to [Partially Permitted].

4. Insert a BD-ROM with BD-LIVE.

The operations may differ depending on the disc. Refer to the manual supplied with the disc.

⚠ Caution

Do not extract the connected USB device while content is being downloaded or a Blu-ray disc is still in the disc slot. Doing so may damage the connected USB device and BD-LIVE features may not operate properly with the damaged USB device anymore. If the connected USB device seems damaged from such an action, you can format the connected USB device from the PC and reuse it with this unit.

! Note

- Some BD-LIVE contents may be restrictively accessed in some territories by contents provider's own decision.
- It may take up to several minutes to load and start enjoying BD-LIVE contents.

Playing a file on a network server

MOVIE MUSIC PHOTO

This player can play movie, music and photo files located in a PC or a DLNA server through your home network.

1. Check the network connection and settings (page 18).
2. Press HOME (🏠).
3. Select [Movie], [Photo] or [Music] using </>, and press ENTER (⊙).
4. Select a DLNA media server or a share folder on your PC on the list using ▲/▼, and press ENTER (⊙).

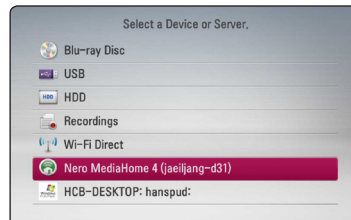

If you want to rescan available media server, press the green (G) coloured button.

5. Select a file using ▲/▼/</>, and press ENTER (⊙) to play the file.

! Note

- The file requirements are described on page 10.
- The thumbnail of the unplayable files can be displayed, but those cannot be played on this unit.
- The subtitle file name and movie file name have to be the same and located at the same folder.
- The playback and operating quality may be affected by your home network condition.
- You may experience connection problems depending on your server's environment.

Wi-Fi Direct™ Connection

Connecting to a Wi-Fi Direct™ certified device

MOVIE MUSIC PHOTO

This player can play movie, music and photo files located in a Wi-Fi Direct™ certified device. The Wi-Fi Direct™ technology make the player to be directly connected to a Wi-Fi Direct™ certified device without connecting to a network device such as an access point.

1. Set the [Wi-Fi Direct] option on the [Setup] menu to [On] (page 35).
2. Press HOME (🏠).
3. Select [Movie], [Photo] or [Music] using </>, and press ENTER (⊙).
4. Select [Wi-Fi Direct] option using ▲/▼, and press ENTER (⊙).



5. Select a Wi-Fi Direct™ device on the list using ▲/▼, and press ENTER (⊙).

Wi-Fi Direct™ connection will be automatically proceeded.



If the Wi-Fi Direct™ device supports the PIN Code configuration method based on WPS (Wi-Fi Protected Setup), select a device on the list and press yellow (Y) coloured button. Note the PIN number on the screen. And then, enter the PIN number on a setting menu of the device to connect.

If you want to rescan available Wi-Fi Direct™ device, press the green (G) coloured button.

6. Select a server that shared from the connected Wi-Fi Direct™ device using **▲/▼**, and press ENTER (⊙) to navigate the server.



To select a server from the device list, files or folders must be shared by DLNA server from the connected Wi-Fi Direct™ device.

7. Select a file using **▲/▼/◀/▶**, and press ENTER (⊙) to play the file.

! Note

- For the purpose of the better transmission, placing the player from the Wi-Fi Direct™ certified server as close as possible.
- This unit can connect only 1 device at a time. Multiple connection is not available.
- If you try to connect wireless network while a device is connected by Wi-Fi Direct™ function, Wi-Fi Direct™ connection will be force disconnected.
- If this player and a Wi-Fi Direct™ device are connected to the different local area network, Wi-Fi Direct™ connection may not available.

Connecting to a Wi-Fi available devices

MOVIE MUSIC PHOTO

This player can connect to a general Wi-Fi device using Wi-Fi Direct™ function.

1. Set the [Wi-Fi Direct] option on the [Setup] menu to [On] (page 35).
2. Press HOME (🏠).
3. Select [Movie], [Photo] or [Music] using **</>**, and press ENTER (⊙).
4. Select [Wi-Fi Direct] option using **▲/▼**, and press ENTER (⊙).

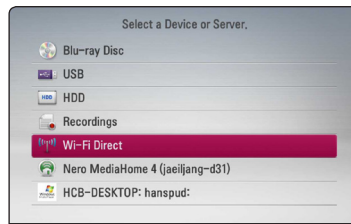

5. Press red (R) coloured button to display the [SSID], [Security Option] and [Encryption] of the player.

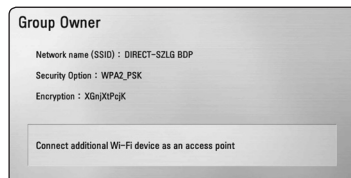

6. On your Wi-Fi device, make a network connection to this player, using [Network name (SSID)], [Security Option] and [Encryption] at step 5 above.
7. Press BACK (⏪) twice to display the device list.

- Select a server that shared from the connected Wi-Fi device using **▲/▼**, and press ENTER (⊙) to navigate the server.

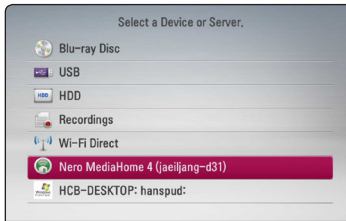

To select a server from the device list, files or folders must be shared by DLNA server from the connected device.

- Select a file using **▲/▼/◀/▶**, and press ENTER (⊙) to play the file.

Playing movie file and VR discs

You can play DVD-RW discs that are recorded in Video Recording (VR) format and movie files contained on a disc/HDD/USB device.

- Press HOME (🏠).

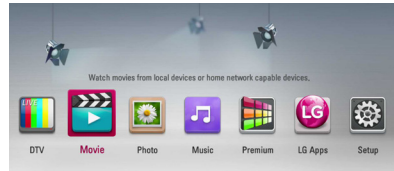

- Select [Movie] using **◀/▶**, and press ENTER (⊙).
- Select [Disc], [USB] or [HDD] option using **▲/▼**, and press ENTER (⊙).

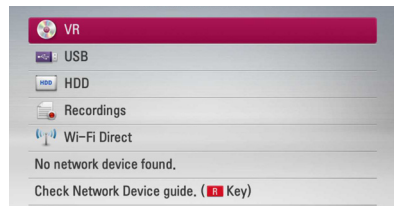

This step is needed only when a disc or a USB device is connected on this unit.

While navigating [Movie], [Photo] or [Music] menu, press green (G) coloured button to change the device. (DISC, USB, HDD or Recordings)

- Select a file using **▲/▼/◀/▶**, and press ▶ (PLAY) or ENTER (⊙) to play the file.

Note

- The file requirements are described on page 10.
- You can use various playback functions. Refer to pages 45-54.
- Unfinalized DVD VR format discs may not be played in this player.
- Some DVD-VR discs are made with CPRM data by DVD RECORDER. This unit cannot support these kinds of discs.

What is CPRM?

CPRM is a copy protection system (with scramble system) only allowing the recording of 'copy once' broadcast programs. CPRM stands for Content Protection for Recordable Media.

Changing subtitle code page

MOVIE MOVIE-N

If the subtitle is not displayed properly, you can change the subtitle code page to view the subtitle file properly.

1. During playback, press INFO/MENU () to display the On-Screen display.
2. Use \wedge/\vee to select the [Code Page] option.
3. Use $\lt;/\gt$ to select desired code option.

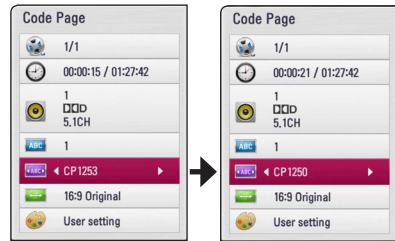

4. Press BACK () to exit the On-Screen display.

Selecting a subtitle file

MOVIE

If a movie file name and the subtitle file name are the same, subtitle file is played automatically when playing the movie file.

If the subtitle file name is different from the movie file name, you need to select the subtitle file on the [Movie] menu before playing the movie.

1. Use $\wedge/\vee/\lt;/\gt$ to select the subtitle file you wish to play in the [Movie] menu.
2. Press ENTER ().

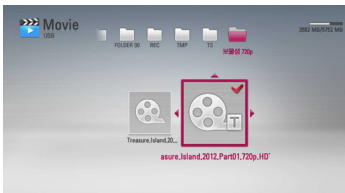

3. Press ENTER () again to deselect the subtitle file. Selected subtitle file will be displayed when you play the movie file.

Note

If you press  (STOP) during playback, the subtitle selection is cancelled.

Viewing a photo

You can view photo files using this player.

1. Press HOME (🏠).

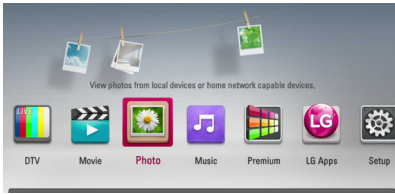

2. Select [Photo] using \leftarrow/\rightarrow , and press ENTER (⊙).
3. Select [Disc], [USB] or [HDD] option using \wedge/\vee , and press ENTER (⊙).

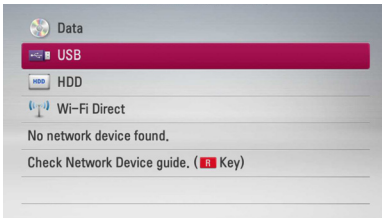

This step is needed only when a disc or a USB device is connected on this unit.

While navigating [Movie], [Photo] or [Music] menu, press green (G) coloured button to change the device. (DISC, USB or HDD)

4. Select a file using $\wedge/\vee/\leftarrow/\rightarrow$, and press ENTER (⊙) to view the photo in full screen.

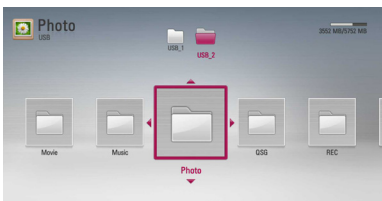

To play a slide show

Press ► (PLAY) to start the slide show.

To stop a slide show

Press ■ (STOP) during slide show.

To pause a slide show

Press || (PAUSE) during slide show.

Press ► (PLAY) to re-start the slide show.

To skip to the next/previous photo

While viewing a photo in full screen, press < or > to go to the previous or next photo.

! Note

The file requirements are described on page 10.

Options while viewing a photo

You can use various options while viewing a photo in full screen.

1. While viewing a photo in full screen, press INFO/MENU (□) to display the option menu.
2. Select an option using \wedge/\vee .



1 Current photo/Total number of photos – Use \langle/\rangle to view previous/next photo.

2 Slide Show – Press ENTER (⊙) to start or pause slide show.

3 Music Select – Select the background music for the slide show (page 66).

4 Music – Press ENTER (⊙) to start or pause background music.

5 Rotate – Press ENTER (⊙) to rotate the photo clockwise.

6 Zoom – Press ENTER (⊙) to display the [Zoom] menu.

7 Effect – Use \langle/\rangle to select a transition effect between photos in a slide show.

8 Speed – Use \langle/\rangle to select a delaying speed between photos in a slide show.

3. Press BACK (⏪) to exit the option menu.

Listening to music during a slide show

You can display photo files while listening to music files.

1. Press HOME (🏠).

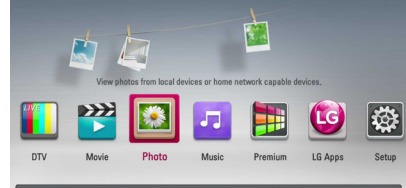

2. Select [Photo] using \langle/\rangle , and press ENTER (⊙).

3. Select [Disc], [USB] or [HDD] option using \wedge/\vee , and press ENTER (⊙).



4. Select a file using $\wedge/\vee/\langle/\rangle$, and press ENTER (⊙) to view the photo.

5. Press INFO/MENU (□) to display the option menu.

6. Use \wedge/\vee to select [Music Select] option, and press ENTER (⊙) to display the [Music Select] menu.

7. Use \wedge/\vee to select a device, and press ENTER (⊙).

Devices that you can select may differ depending on the location of the photo file you are displaying in full screen.

Photo location	Available Device
Disc, USB, HDD	Disc, USB, HDD
DLNA server	DLNA server

8. Use \wedge/\vee to select a file or a folder you wish to play.

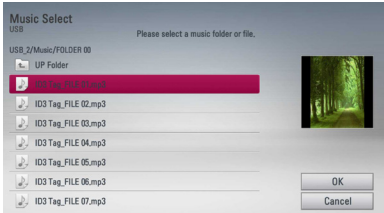

Select a folder and press ENTER (⊙) to display the lower directory.

Select \square and press ENTER (⊙) to display the upper directory.

Note

When selecting music file from a server, folder selection is not available. Only file selection is available.

9. Use $\>$ to select [OK], and press ENTER (⊙) to complete music selection.

Listening to music

This player can play Audio CDs and music files.

1. Press HOME (🏠).

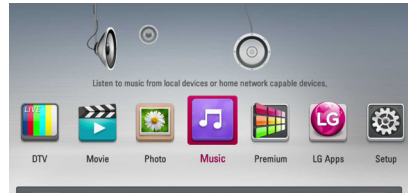

2. Select [Music] using \leftarrow/\rightarrow , and press ENTER (⊙).
3. Select the [Disc], [USB] or [HDD] option using \wedge/\vee , and press ENTER (⊙).

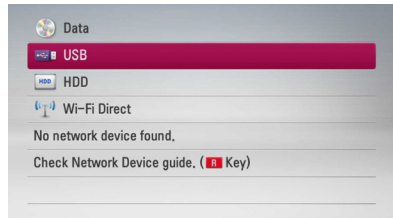

This step is needed only when a disc or a USB device is connected on this unit.

While navigating [Movie], [Photo] or [Music] menu, press green (G) colored button to change the device. (DISC, USB or HDD)

4. Select a music file or audio track using $\wedge/\vee/\leftarrow/\rightarrow$, and press ENTER (⊙) to play the music.



Note

The file requirements are described on page 10.

Audio CD Recording

You can record one desired track or all of the tracks in Audio CD to the internal hard disk drive or a USB storage device.

1. Press OPEN/CLOSE (▲), and place an Audio CD on the disc tray.
Press OPEN/CLOSE (▲) to close the disc tray.
The playback starts automatically.
2. Press INFO/MENU (□) to display the option menu.
3. Use ▲/▼ to select [CD Recording] option, and press ENTER (⊙) to display the [CD Recording] menu.
4. Use ▲/▼ to select a track you wish to copy on the menu, and press ENTER (⊙).

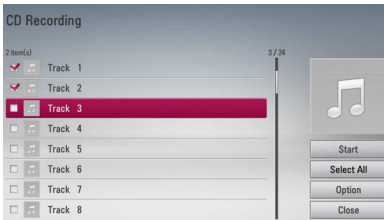

Repeat this step to select tracks as many as you can.

Select All	Select all the tracks on an Audio CD.
Option	Selects an encoding option from the pop-up menu (128 kbps, 192 kbps, 320 kbps or Lossless).
Close	Cancels the recording and returns to the previous screen.

5. Use ▲/▼/◀/▶ to select [Start], and press ENTER (⊙).
6. Select the [USB] or [HDD] option using ▲/▼, and press ENTER (⊙).

This step is needed only when a USB storage device is connected.

7. Use ▲/▼/◀/▶ to select a destination folder to be copied, and press ENTER (⊙).

If you want to create a new folder, use ▲/▼/◀/▶ to select [New Folder] and press ENTER (⊙).

8. Use ▲/▼/◀/▶ to select [OK], and press ENTER (⊙) to start Audio CD archiving.

If you want to stop in progressing Audio CD archiving, press ENTER (⊙) while [Cancel] is highlighted.

9. A message appears when Audio CD archiving is completed.
Press ENTER (⊙) to check the audio file created in the destination folder.

! Note

- The table below shows the average recording time from an audio track with 4 minutes of playback time to an audio file with 192kbps as an example

Device	Status stop mode	while playback
Internal HDD	15 sec.	23 sec.
USB	1.4 min.	2 min.

- All times in the above table are approximate.
- Actual recording time for USB storage device varies depending on the USB storage device's ability.
- Make sure that there is minimum of 50MB free space is needed when recording into the USB storage device.
- The length of the music should be longer than 20 seconds for the proper recording.
- Do not turn off this player or extract the connected USB storage device during Audio CD recording.

! Caution

The making of unauthorized copies of copy-protected material, including computer programs, files, broadcasts and sound recordings, may be an infringement of copyrights and constitute a criminal offense. This equipment should not be used for such purposes.

**Be responsible
Respect copyrights**

Viewing information from Gracenote Media Database

The player can access the Gracenote Media Database and loads the music information so that Track name, Artist Name, Genre and other text information can be displayed on the list.

Audio CD

When you insert an Audio CD, the player starts playback automatically and load the music title from the Gracenote Media Database.

If there is no music information in the database, music titles will not be displayed on the screen.

Music file

1. Select a music file using $\wedge/V/</>$.
2. Press INFO/MENU (\square) to display the option menu.
3. Select the [Information] option using \wedge/V , and press ENTER (\odot).

The player accesses Gracenote Media Database for the music information.

Blu-ray Disc/DVD/Video file

While listening to a music from the movie being played, press MUSIC ID to start loading the music information from the Gracenote Media Database.

! Note

- The player must be connected to the broadband internet for accessing the Gracenote Media Database.
- If the music information is not in the Gracenote Media Database, message appears on the screen.
- If the information from the Gracenote Media Database is either not correct or does not exist, please contact www.gracenote.com for support.
- Depending on the cases, it will takes a few minutes to load music information from the Gracenote Media Database.
- Information may be displayed in broken letters, if the language you selected is not available on the Gracenote Media Database.
- This function is not available for NetCast on-line content and content in DLNA servers.
- LG is a licensee of Gracenote technology and is not responsible or reliable for information from the Gracenote Media Database.
- Audio CDs that users made for their only private purposes cannot be supported in this feature because they are not in the Gracenote Media Database.
- Supported audio file extensions : mp3, wma, m4a

Using the Music Library

The player offers Music Library menu for the music contents stored in the internal hard disk drive. The player accesses the Gracenote Media Database and loads the music information for all of the music contents in the internal hard disk drive. You can also manage the music contents by various categories from the Music Library menu.

1. Press HOME (🏠).
2. Select [Music] using </>, and press ENTER (⊙).
3. Select the [HDD] using ^/∨, and press ENTER (⊙).



4. Press INFO/MENU (ℹ) to display the option menu.
5. Use ^/∨ to select [Library mode] option, and press ENTER (⊙) to display the [Library] menu. If you want to return to the directory mode, press INFO/MENU (ℹ) and select [Directory mode] and press ENTER (⊙).
6. All the audio files stored in the internal hard disk drive are sorted by categories with the music information loaded from Gracenote Media Database. Use ^/∨ to select a category.



Songs – All audio files stored in the internal hard disk drive are sorted by name in alphabetical order.

Genres – Audio files stored in the internal hard disk drive are sorted by genre information from Gracenote Media Database.

Artists – Music stored in the internal hard disk drive are sorted by artist name from Gracenote Media Database in alphabetical order.

Albums – All music stored in the internal hard disk drive are sorted by album title from Gracenote Media Database in alphabetical order.

PlayLists – Displays audio files you have added to your playlist or displays audio files using several filter options.

You can search easily a content using power scroll bar. Use > repeatedly to select the power scroll bar on the right side of the screen.

Use ^/∨ to select a letter, and press ENTER (⊙) to move the cursor to the music title which start with the letter you were selected.

! Note

The player must be connected to the Internet in order to use the Music Library.

Adding an audio file to your playlist

1. Use $\wedge/\vee/ </>$ to select a directory that files you want to add to the playlist are located.
2. Press INFO/MENU (\square) to display the option menu.
3. Use \wedge/\vee to select [Add to playlist] option, and press ENTER (\odot) to display the [Add to playlist] menu.
4. Use \wedge/\vee to select a file you wish to add to the playlist, and press ENTER (\odot).

Repeat this step to select files as many as you can.



Select All

Select all the files in the current directory.

Close

Cancels and returns to the previous screen.

5. Use $\wedge/\vee/ </>$ to select [Start], and press ENTER (\odot).

Deleting an audio file from your playlist

1. On the Music Library menu, use \wedge/\vee to select [PlayList], and press ENTER (\odot).
2. Use \wedge/\vee to select [My Playlist] option, and press ENTER (\odot) to display your playlist.
3. Press INFO/MENU (\square) to display the option menu.
4. Use \wedge/\vee to select [Delete from playlist] option, and press ENTER (\odot) to display the [Delete from Playlist] menu.
5. Use \wedge/\vee to select a file you wish to add to the playlist, and press ENTER (\odot).

Repeat this step to select files as many as you can.

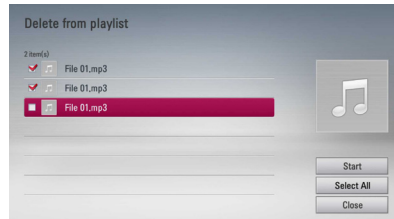

Select All

Select all the files in the current directory.

Close

Cancels and returns to the previous screen.

6. Use $\wedge/\vee/ </>$ to select [Start], and press ENTER (\odot).

Using the Photo Library

The player offers Photo Library menu for the photos stored in the internal hard disk drive.

1. Press HOME (🏠).
2. Select [Photo] using </>, and press ENTER (⊙).
3. Select the [HDD] using ^/V, and press ENTER (⊙).
4. Press INFO/MENU (ℹ) to display the option menu.
5. Use ^/V to select [Library mode] option, and press ENTER (⊙) to display the [Library] menu.

If you want to return to the directory mode, press INFO/MENU (ℹ) and select [Directory mode] and press ENTER (⊙).

6. Photo files stored in the internal hard disk drive are sorted by the date when original image was taken and displayed in the calendar.

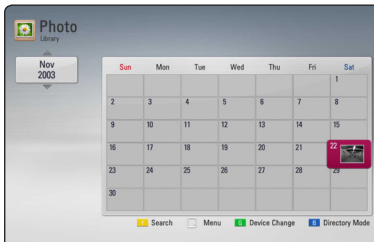

7. Use ^/V/</> to select a date, and press ENTER (⊙) to display photos created in that date.
8. Use ^/V/</> to select a photo file, and press ENTER (⊙) to display the photo in full screen.

! Note

A photo file may not be displayed in photo library mode, if the photo file does not have the information of taken date.

Using the Premium

You can use various content services via Internet with the Premium feature.

1. Check the network connection and settings (page 18).
2. Press HOME (🏠).
3. Select the [Premium] using </>, and press ENTER (⊙).

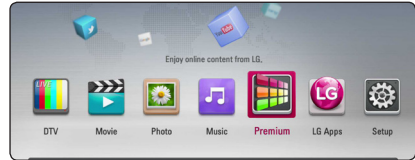

4. Select an online service using ^/V/</>, and press ENTER (⊙).

! Note

- Detailed information of each service, contact to the content provider or visit support link of the service.
- The content of Premium services and service related information, including user interface, is subject to changes. Please refer to the web site of each service for most up-to-date information.
- Using Premium features with wireless network connection may result in improper streaming speed by interference from household devices that are using radio frequencies.
- When you are first time to access [Premium] or [LG Apps] feature, current country setting appears. If you want to change the country setting, select [Edit] and press ENTER (⊙).

Using the LG Apps

You can use the LG application services on this player via Internet. You can easily find and download various applications from LG App store.

Depending on the region, the LG Apps service may not be available at the moment. The service will become available in these regions through a software update.

1. Check the network connection and settings (page 18).
2. Press HOME (🏠).
3. Select the [LG Apps] using </>, and press ENTER (⊙).

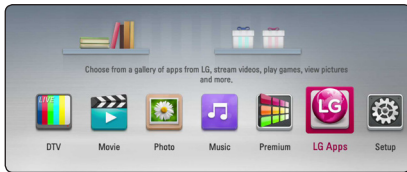

4. Select a category using </>, and press ENTER (⊙).
5. Use ^/∨/</> to select an application, and press ENTER (⊙) to display the information.
6. Press ENTER (⊙) while [Install] icon is highlighted. The application will be installed to the player.

To install an application to the player, user needs to sign in. Refer to page 72 for more information of signing in.

7. Press yellow (Y) coloured button to display the [My Apps] screen.
8. Select the installed application and press ENTER (⊙) to execute it.

! Note

To install a paid application, you need to be a paid member. Visit www.lgappstv.com for more information.

Signing in

To use the [LG Apps] feature, you need to sign in with your account.

1. On the [LG Apps] or [My Apps] screen, press red (R) colored button.
2. Fill the [ID] and [Password] field using the virtual keyboard.

If you do not have an account, press red (R) coloured button to register.

3. Use ^/∨/</> to select [OK], and press ENTER (⊙) to sign in with your account.

If you select the [Auto Sign In] check box, your ID and password are remembered and automatically signed in without entering them.

! Note

- If you want to sign in with other account, press red (R) coloured button on [LG Apps] or [My Apps] screen, and select [Change User] option.
- To view the information of your account and applications, press red (R) colored button on [LG Apps] or [My Apps] screen, and select [Account Setting] option.

Managing my Apps

You can move or delete an installed application in the [My Apps] menu.

Move an application

1. Select an application, and press green (G) colored button to display the options.
2. Use ^/∨ to select [Move], and press ENTER (⊙).
3. Use ^/∨/</> to select a position you want to move to, and press ENTER (⊙).

Delete an application

1. Select an application, and press green (G) colored button to display the options.
2. Use ^/∨ to select [Delete], and press ENTER (⊙).
3. Use </> to select [Yes], and press ENTER (⊙) to confirm.

Searching online content

If you are having difficulties finding specific content from online services, you can use the all-in-one search function by entering keywords in the [Search] menu.

1. Press HOME (🏠).
2. Select the [Search] on the launcher bar using **▲/▼/◀/▶**, and press ENTER (⊙).
The [Search] menu appears on the screen with virtual keyboard.
3. Use **▲/▼/◀/▶** to select letters then press ENTER (⊙) to confirm your selection on the virtual keyboard.
4. When you finish entering the keyword, select [OK] and press ENTER (⊙) to display search result.
5. Use **▲/▼/◀/▶** to select a desired content, and press ENTER (⊙) to move to the selected content directly.



Note

The [Search] function does not search content in every online services. It works only in certain online services.

Troubleshooting

General

Symptoms	Cause & Solution
The Power does not turn on.	<ul style="list-style-type: none"> • Plug the power cord into the wall outlet securely.
The unit does not start playback.	<ul style="list-style-type: none"> • Insert a playable disc. (Check the disc type, color system, and regional code.) • Insert the disc with the playback side down. • Clean the disc. • Cancel the Rating function or change the rating level.
The angle cannot be changed.	<ul style="list-style-type: none"> • Multi-angles are not recorded on the DVD Video being played.
Cannot play movie, photo or audio files.	<ul style="list-style-type: none"> • The files are not recorded in a format that the unit can play. • The unit does not support the codec of the movie file.
The remote control does not work properly.	<ul style="list-style-type: none"> • The remote control is not pointed at the remote sensor of the unit. • The remote control is too far from the unit. • There is an obstacle in the path between the remote control and the unit. • The batteries in the remote control are exhausted.

Picture

Symptom	Cause & Solution
There is no picture.	<ul style="list-style-type: none"> • Select the appropriate video input mode on the TV so the picture from the unit appears on the TV screen. • Connect the video connection securely. • Check the [HDMI Color Setting] in the [Setup] menu is set to the appropriate item that conforms to your video connection. • Your TV may not support the resolution you have set on the unit. Change the resolution to one that your TV accepts. • The player's HDMI OUT jack is connected to a DVI device that does not support copyright protection.
Picture noise appears	<ul style="list-style-type: none"> • You are playing a disc recorded in a colour system that is different from your TV. • Set the resolution to one that your TV accepts.

Sound

Symptom	Cause & Solution
There is no sound or the sound is distorted.	<ul style="list-style-type: none"> • Connect the audio connection securely. • The input source setting on the amplifier or the connection to the amplifier is incorrect. • The unit is in scan, slow motion, or pause mode. • The sound volume is low. • Check that the connected amplifier is compatible with the audio format output from the player. • The player's HDMI OUT jack is connected to a DVI device. The DVI jack does not accept audio signal. • Check the device connected to the player's HDMI OUT jack is compatible with the audio format output from the unit.

Network

Symptom	Cause & Solution
BD-LIVE feature does not work.	<ul style="list-style-type: none"> • The connected USB storage may not have enough space. Connect the USB storage with at least 1GB free space. • Ensure that the unit is correctly connected to the local area network and can access the internet (see pages 18-22). • Your broadband speed may not be fast enough to use the BD-Live features. Contact your Internet Service Provider (ISP) and increase the broadband speed to suit the unit's requirements. • The [BD-LIVE connection] option in the [Setup] menu is set to [Prohibited]. Set the option to [Permitted].
Streaming video services (such as YouTube™, etc.) are often stop or "buffer" during playback.	<ul style="list-style-type: none"> • Your broadband service speed may not be fast enough to stream video services. Contact your Internet Service Provider (ISP) and increase the broadband speed is recommended.
Shared folder or files from your PC or a media server are not displayed on the [Home Link] menu.	<ul style="list-style-type: none"> • The firewall or anti-virus software on your media server is running. Turn off the firewall or anti-virus software running on your PC or media server. • The unit is not connected to the local area network that your PC or the media server are connected.
Cannot connect the player to the access point or wireless LAN router.	<ul style="list-style-type: none"> • The wireless communication may be interrupted from household devices that are using radio frequencies. Move the player away from them.
Access point is not displayed on the "Access point name" list.	<ul style="list-style-type: none"> • The access point or wireless LAN router may not broadcast its SSID. Set your access point to broadcast its SSID through your computer.

Recording

Symptom	Cause & Solution
Cannot record or does not record successfully.	<ul style="list-style-type: none"> • Check the remaining space on the HDD. • If your source is copy-protected, you cannot record it using this recorder. • If you set a DTV rating for the recorder and higher rated digital programs are received, the programme cannot be recorded. Change the DTV rating level in order to record it.
Timer record does not record successfully.	<ul style="list-style-type: none"> • Clock is not set to correct time. • The start time of the timer recording is past. • When setting the recording programme, make sure you set the recorder's built-in tuner, not the TV's built-in tuner. • If the HDD is damaged, the recording may not complete successfully. • If you set two timer recordings at the same time, one of that proceeds after another does. Second Timer recording may proceed in a minute.
You cannot enter a timer programme when.	<ul style="list-style-type: none"> • In the case that two channels is recording. • The time you're trying to set has already passed. • There are already 32 timer programs set.
If two or more timer programs overlap.	<ul style="list-style-type: none"> • The earlier programme takes priority. • In the case a reserved recording is started during recording two channels and a user uses another menu, the reserved recording cannot be operated.

Customer Support

You can update the Player using the latest software to enhance the products operation and/or add new features. To obtain the latest software for this player (if updates have been made), please visit <http://lgservice.com> or contact LG Electronics customer care centre.

Open source software notice

To obtain the corresponding source code under GPL, LGPL and other open source licenses, please visit <http://opensource.lge.com>. All referred license terms, warranty disclaimers and copyright notices are available to download with the source code.

Controlling a TV with the Supplied Remote Control

You can control your TV using the buttons below.

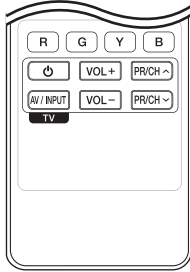

By pressing	You can
⏻ (TV POWER)	Turn the TV on or off.
AV/INPUT	Switch the TV's input source between the TV and other input sources.
PR/CH ▲/▼	Scan up or down through memorized channels.
VOL +/-	Adjust the volume of the TV

! Note

Depending on the unit being connected, you may not be able to control your TV using some of the buttons.

Setting up the remote to control your TV

You can operate your TV with the supplied remote control.

If your TV is listed in the table below, set the appropriate manufacturer code.

1. While holding down ⏻ (TV POWER) button, press the manufacturer code for your TV with the numerical buttons (see the table below).

Manufacturer	Code Number
LG	1(Default), 2
Zenith	1, 3, 4
GoldStar	1, 2
Samsung	6, 7
Sony	8, 9
Hitachi	4

2. Release the ⏻ (TV POWER) button to complete setting.

Depending on your TV, some or all buttons may not function on the TV, even after entering the correct manufacturer code. When you replace the batteries in the remote, the code number you have set may be reset to the default setting. Set the appropriate code number again.

Area Code List

Choose an area code from this list.

Area	Code	Area	Code	Area	Code	Area	Code
Afghanistan	AF	Fiji	FJ	Monaco	MC	Singapore	SG
Argentina	AR	Finland	FI	Mongolia	MN	Slovak Republic	SK
Australia	AU	France	FR	Morocco	MA	Slovenia	SI
Austria	AT	Germany	DE	Nepal	NP	South Africa	ZA
Belgium	BE	Great Britain	GB	Netherlands	NL	South Korea	KR
Bhutan	BT	Greece	GR	Antilles	AN	Spain	ES
Bolivia	BO	Greenland	GL	New Zealand	NZ	Sri Lanka	LK
Brazil	BR	Hong Kong	HK	Nigeria	NG	Sweden	SE
Cambodia	KH	Hungary	HU	Norway	NO	Switzerland	CH
Canada	CA	India	IN	Oman	OM	Taiwan	TW
Chile	CL	Indonesia	ID	Pakistan	PK	Thailand	TH
China	CN	Israel	IL	Panama	PA	Turkey	TR
Colombia	CO	Italy	IT	Paraguay	PY	Uganda	UG
Congo	CG	Jamaica	JM	Philippines	PH	Ukraine	UA
Costa Rica	CR	Japan	JP	Poland	PL	United States	US
Croatia	HR	Kenya	KE	Portugal	PT	Uruguay	UY
Czech Republic	CZ	Kuwait	KW	Romania	RO	Uzbekistan	UZ
Denmark	DK	Libya	LY	Russian		Vietnam	VN
Ecuador	EC	Luxembourg	LU	Federation	RU	Zimbabwe	ZW
Egypt	EG	Malaysia	MY	Saudi Arabia	SA		
El Salvador	SV	Maldives	MV	Senegal	SN		
Ethiopia	ET	Mexico	MX				

Language code List

Use this list to input your desired language for the following initial settings: [Disc Audio], [Disc Subtitle] and [Disc Menu].

Language	Code	Language	Code	Language	Code	Language	Code
Afar	6565	French	7082	Lithuanian	7684	Sindhi	8368
Afrikaans	6570	Frisian	7089	Macedonian	7775	Singhalese	8373
Albanian	8381	Galician	7176	Malagasy	7771	Slovak	8375
Ameharic	6577	Georgian	7565	Malay	7783	Slovenian	8376
Arabic	6582	German	6869	Malayalam	7776	Spanish	6983
Armenian	7289	Greek	6976	Maori	7773	Sudanese	8385
Assamese	6583	Greenlandic	7576	Marathi	7782	Swahili	8387
Aymara	6588	Guarani	7178	Moldavian	7779	Swedish	8386
Azerbaijani	6590	Gujarati	7185	Mongolian	7778	Tagalog	8476
Bashkir	6665	Hausa	7265	Nauru	7865	Language	Code
Basque	6985	Hebrew	7387	Nepali	7869	Tajik	8471
Bengali; Bangla	6678	Hindi	7273	Norwegian	7879	Tamil	8465
Bhutani	6890	Hungarian	7285	Oriya	7982	Telugu	8469
Bihari	6672	Icelandic	7383	Panjabi	8065	Thai	8472
Breton	6682	Indonesian	7378	Pashto, Pushto	8083	Tonga	8479
Bulgarian	6671	Interlingua	7365	Persian	7065	Turkish	8482
Burmese	7789	Irish	7165	Polish	8076	Turkmen	8475
Byelorussian	6669	Italian	7384	Portuguese	8084	Twi	8487
Chinese	9072	Japanese	7465	Quechua	8185	Ukrainian	8575
Croatian	7282	Kannada	7578	Rhaeto-Romance	8277	Urdu	8582
Czech	6783	Kashmiri	7583	Rumanian	8279	Uzbek	8590
Danish	6865	Kazakh	7575	Russian	8285	Vietnamese	8673
Dutch	7876	Kirghiz	7589	Samoan	8377	Volapük	8679
English	6978	Korean	7579	Sanskrit	8365	Welsh	6789
Esperanto	6979	Kurdish	7585	Scots Gaelic	7168	Wolof	8779
Estonian	6984	Laothian	7679	Serbian	8382	Xhosa	8872
Faroese	7079	Latin	7665	Serbo-Croatian	8372	Yiddish	7473
Fiji	7074	Latvian, Lettish	7686	Shona	8378	Yoruba	8979
Finnish	7073	Lingala	7678			Zulu	9085

Trademarks and Licenses



Blu-ray Disc™, Blu-ray™, Blu-ray 3D™, BD-Live™, BONUSVIEW™ and the logos are trademarks of the Blu-ray Disc Association.



Java is a trademark of Oracle and/or its affiliates.



Manufactured under license from Dolby Laboratories. Dolby and the double-D symbol are trademarks of Dolby Laboratories



The terms HDMI and HDMI High-Definition Multimedia Interface, and the HDMI logo are trademarks or registered trademarks of HDMI Licensing LLC in the United States and other countries.



“DVD Logo” is a trademark of DVD Format/Logo Licensing Corporation.



“AVCHD” and the “AVCHD” logo are trademarks of Panasonic Corporation and Sony Corporation.



Manufactured under license under U.S. Patent #'s: 5,451,942; 5,956,674; 5,974,380; 5,978,762; 6,226,616; 6,487,535; 7,212,872; 7,333,929; 7,392,195; 7,272,567 & other U.S. and worldwide patents issued & pending. DTS is a registered trademark and the DTS logos, Symbol, DTS-HD and DTS-HD Master Audio are trademarks of DTS, Inc. © 1996-2008 DTS, Inc. All Rights Reserved.



DivX®, DivX Certified® and associated logos are trademarks of Rovi Corporation or its subsidiaries, and are used under license.



The Wi-Fi CERTIFIED Logo is a certification mark of the Wi-Fi Alliance.

“x.v.Colour” is a trademark of Sony Corporation.

consumption system in stand-by mode is built. There fore, the small amounts of electricity are consumed even though the power plug is inserted.



Gracenote®, Gracenote logo and logotype, and the “Powered by Gracenote” logo are either registered trademarks or trademarks of Gracenote, Inc. in the United States and/or other countries.

Music recognition technology and related data are provided by Gracenote®.

Portions of the content is copyright © Gracenote or its providers.

Gracenote®, Gracenote logo and logotype, and the “Powered by Gracenote” logo are either registered trademarks or trademarks of Gracenote, Inc. in the United States and/or other countries.

Music recognition technology and related data are provided by Gracenote®.

Portions of the content is copyright © Gracenote or its providers.

Gracenote® End User License Agreement

This application or device contains software from Gracenote, Inc. of Emeryville, California (“Gracenote”). The software from Gracenote (the “Gracenote Software”) enables this application to perform disc and/or file identification and obtain music-related information, including name, artist, track, and title information (“Gracenote Data”) from online servers or embedded databases (collectively, “Gracenote Servers”) and to perform other functions. You may use Gracenote Data only by means of the intended End-User functions of this application or device.

You agree that you will use Gracenote Data, the Gracenote Software, and Gracenote Servers for your own personal non-commercial use only. You agree not to assign, copy, transfer or transmit the Gracenote Software or any Gracenote Data to any third party. YOU AGREE NOT TO USE OR EXPLOIT GRACENOTE DATA, THE GRACENOTE SOFTWARE, OR GRACENOTE SERVERS, EXCEPT AS EXPRESSLY PERMITTED HEREIN.

You agree that your non-exclusive license to use the Gracenote Data, the Gracenote Software, and Gracenote Servers will terminate if you violate these restrictions. If your license terminates, you agree to cease any and all use of the Gracenote Data, the Gracenote Software, and Gracenote

Servers. Gracenote reserves all rights in Gracenote Data, the Gracenote Software, and the Gracenote Servers, including all ownership rights. Under no circumstances will Gracenote become liable for any payment to you for any information that you provide. You agree that Gracenote, Inc. may enforce its rights under this Agreement against you directly in its own name.

The Gracenote service uses a unique identifier to track queries for statistical purposes. The purpose of a randomly assigned numeric identifier is to allow the Gracenote service to count queries without knowing anything about who you are. For more information, see the web page for the Gracenote Privacy Policy for the Gracenote service.

The Gracenote Software and each item of Gracenote Data are licensed to you “AS IS.” Gracenote makes no representations or warranties, express or implied, regarding the accuracy of any Gracenote Data from in the Gracenote Servers. Gracenote reserves the right to delete data from the Gracenote Servers or to change data categories for any cause that Gracenote deems sufficient. No warranty is made that the Gracenote Software or Gracenote Servers are error-free or that functioning of Gracenote Software or Gracenote Servers will be uninterrupted. Gracenote is not obligated to provide you with new enhanced or additional data types or categories that Gracenote may provide in the future and is free to discontinue its services at any time.

GRACENOTE DISCLAIMS ALL WARRANTIES EXPRESS OR IMPLIED, INCLUDING, BUT NOT LIMITED TO, IMPLIED WARRANTIES OF MERCHANTABILITY, FITNESS FOR A PARTICULAR PURPOSE, TITLE, AND NON-INFRINGEMENT. GRACENOTE DOES NOT WARRANT THE RESULTS THAT WILL BE OBTAINED BY YOUR USE OF THE GRACENOTE SOFTWARE OR ANY GRACENOTE SERVER. IN NO CASE WILL GRACENOTE BE LIABLE FOR ANY CONSEQUENTIAL OR INCIDENTAL DAMAGES OR FOR ANY LOST PROFITS OR LOST REVENUES.

© Gracenote, Inc. 2009

Cinavia Notice

This product uses Cinavia technology to limit the use of unauthorized copies of some commercially-produced film and videos and their soundtracks. When a prohibited use of an unauthorized copy is detected, a message will be displayed and playback or copying will be interrupted.

More information about Cinavia technology is provided at the Cinavia Online Consumer Information Center at <http://www.cinavia.com>. To request additional information about Cinavia by mail, send a postcard with your mailing address to: Cinavia Consumer Information Center, P.O. Box 86851, San Diego, CA, 92138, USA.

This product incorporates proprietary technology under license from Verance Corporation and is protected by U.S. Patent 7,369,677 and other U.S. and worldwide patents issued and pending as well as copyright and trade secret protection for certain aspects of such technology. Cinavia is a trademark of Verance Corporation. Copyright 2004-2010 Verance Corporation. All rights reserved by Verance. Reverse engineering or disassembly is prohibited.

Network Software Update

Network update notification

From time to time, performance improvements and/or additional features or services may be made available to units that are connected to a broadband home network. If there is new software available and the unit is connected to a broadband home network, the player will inform you about the update as follows.

Option 1:

1. The update menu will appear on the screen when you turn on the player.
2. Use **</>** to select a desired option and then press ENTER (⊙).

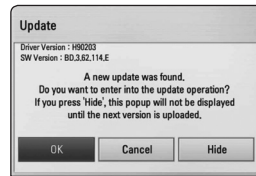

[OK]	Starts the software update.
[Cancel]	Exits the update menu and displays it next booting.
[Hide]	Exits the update menu and it does not appear until next software is uploaded in the update server.

Option 2:

If the software update is available from the update server, the "Update" icon appears in the Home menu. Press blue (B) coloured button to start the update procedure.

Software Update

You can update the player using the latest software to enhance the products operation and/or add new features. You can update the software by connecting the unit directly to the software update server.

! Note

- Before updating the software in your player, remove any disc and USB Device from the unit.
- Before updating the software in your player, turn the player off and then turn it back on.
- During the software update procedure, do not turn off the player or disconnect AC power, or do not press any button.
- If you cancel the update, turn off the power and turn it on for stable performance.
- This unit cannot be updated to previous software version.

1. Check the network connection and settings (pages 18-22).
2. Select [Software] option in the [Setup] menu then press ENTER (⊙).
3. Select [Update] option, and press ENTER (⊙).

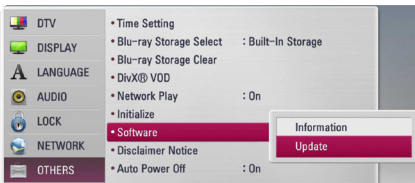

The unit will check for the newest update.

! Note

- Pressing ENTER (⊙) while checking for the update will end the process.
- If there is no update available, the Message, "No update is found." appears. Press ENTER (⊙) to return to the [Home Menu].

4. If newer version exists, the message "Do you want to update?" appears.

5. Select [OK] to start update. (Selecting [Cancel] will end the update.)

! Caution

Do not turn off the power during the software update.

! Note

If the software includes the driver update, disc tray may open during the process.

6. When update is completed, the message, "Update is complete." will appear, and then power will turn off automatically after 5 seconds.
7. Turn the power back on. The system now operates with the new version.

! Note

The Software Update function may not work properly depending on your internet environment. In this case, you can obtain the latest software from the authorized LG Electronics Service Centre then update your player. Refer to "Customer Support" on page 76.

MediaHome 4 Essentials

Nero MediaHome 4 Essentials is a software for sharing video, audio and photo files stored on your computer to this player as a DLNA-compatible digital media server.

! Note

- The Nero MediaHome 4 Essentials CD-ROM is designed for PCs and should not be inserted in this player or in any product other than a PC.
- The supplied Nero MediaHome 4 Essentials CD-ROM is a customized software edition only for sharing files and folders to this player.
- The supplied Nero MediaHome 4 Essentials software does not support following functions: Transcoding, Remote UI, TV control, Internet services and Apple iTunes.
- The supplied Nero MediaHome 4 Essentials software can be downloaded at
 - Windows : <http://www.nero.com/download.php?id=nmhlgewin>
 - Mac OS : <http://www.nero.com/download.php?id=nmhlgemac>
- This manual explains operations with the English version of Nero MediaHome 4 Essentials as examples. Follow the explanation referring to the actual operations of your language version.

System requirements

Windows PC

- Windows® XP (Service Pack 2 or higher), Windows Vista® (no Service Pack required), Windows® 7 (no Service Pack required), Windows® XP Media Center Edition 2005 (Service Pack 2 or higher), Windows Server® 2003
- Windows Vista® 64-bit edition (application runs in 32-bit mode)
- Windows® 7 64-bit edition (application runs in 32-bit mode)

- Hard drive space: 200 MB hard drive space for a typical installation of Nero MediaHome stand-alone
- 1.2 GHz Intel® Pentium® III or AMD Sempron™ 2200+ processors
- Memory: 256 MB RAM
- Graphics card with at least 32 MB video memory, minimum resolution of 800 x 600 pixels, and 16-bit color settings
- Windows® Internet Explorer® 6.0 or higher
- DirectX® 9.0c revision 30 (August 2006) or higher
- Network environment: 100 Mb Ethernet, WLAN

Macintosh

- Mac OS X 10.5 (Leopard) or 10.6 (Snow Leopard)
- Macintosh computer with an Intel x86 processor
- Hard drive space: 200 MB hard drive space for a typical installation of Nero MediaHome stand-alone
- Memory: 256 MB RAM

Installing Nero MediaHome 4 Essentials

Windows

Start up your computer, and insert the supplied CD-ROM disc into your computer's CD-ROM drive. An installation wizard will walk you through the quick and uncomplicated installation process. To install Nero MediaHome 4 Essentials, proceed as follows:

1. Close all Microsoft Windows programs and exit any anti-virus software that may be running.
2. Insert the supplied CD-ROM disc into your computer's CD-ROM drive.
3. Click [Nero MediaHome 4 Essentials].
4. Click [Run] to start installation.
5. Click [Nero MediaHome 4 Essentials]. The installation is prepared and the installation wizard appears.
6. Click the [Next] button to display the serial number input screen. Click [Next] to go to the next step.
7. If you accept all conditions, click [I accept the License Conditions] check box and click [Next]. Installation is not possible without this agreement.

8. Click [Typical] and click [Next]. The installation process is started.
9. If you want to take part in the anonymous collection of data, select the check box and click the [Next] button.
10. Click the [Exit] button to complete the installation.

MAC OS X

1. Start up your computer, and insert the supplied CD-ROM disc into your computer's CD-ROM drive.
2. Browse the CD-ROM drive and open the "MediaHome_4_Essentials_MAC" folder.
3. Double-click the "Nero MediaHome.dmg" image file. The Nero MediaHome window is opened.
4. In the Nero MediaHome window, drag the Nero MediaHome icon either to the Applications folder within the window or to any other desired location.
5. You can now start the application by double-clicking the Nero MediaHome icon in the location you dragged it to.

Sharing files and folders

On your computer, you must share the folder contained video, audio and/or photo content to play them on this player.

This parts explains the procedure for selecting the shared folders on your computer.

1. Double-click the "Nero MediaHome 4 Essentials" icon.
2. Click [Network] icon on the left and define your network name in the [Network name] field. The Network name you enter will be recognized by your player.
3. Click [Shares] icon on the left.
4. Click [Local Folders] tab on the [Shares] screen.
5. Click [Add] icon to open the [Browse Folder] window.
6. Select the folder containing the files you want to share. The selected folder is added to the list of shared folders.
7. Click [Start Server] icon to start the server.

Note

- If the shared folders or files are not displayed on the player, click the folder on the [Local Folders] tab and click [Rescan Folder] at the [More] button.
- Visit www.nero.com for more information and software tools.

Audio Output Specifications

Jack/Setting Source	Digital Output (DIGITAL AUDIO OUT) *4		
	PCM Stereo	DTS Re-Encode*3 *5	Primary Pass-Thru
Dolby Digital	PCM 2ch	DTS	Dolby Digital
Dolby Digital Plus	PCM 2ch	DTS	Dolby Digital
Dolby TrueHD	PCM 2ch	DTS	Dolby Digital
DTS	PCM 2ch	DTS	DTS
DTS-HD	PCM 2ch	DTS	DTS
Linear PCM 2ch	PCM 2ch	DTS	PCM 2ch
Linear PCM 5.1ch	PCM 2ch	DTS	PCM 2ch
Linear PCM 7.1ch	PCM 2ch	DTS	PCM 2ch

Jack/Setting Source	HDMI OUT			
	PCM Stereo	PCM Multi-Ch *3	DTS Re-Encode*3 *5	Primary Pass-Thru *1 *2 *3
Dolby Digital	PCM 2ch	PCM 2ch	DTS	Dolby Digital
Dolby Digital Plus	PCM 2ch	PCM 2ch	DTS	Dolby Digital Plus
Dolby TrueHD	PCM 2ch	PCM 2ch	DTS	Dolby TrueHD
DTS	PCM 2ch	PCM 5.1ch	DTS	DTS
DTS-HD	PCM 2ch	PCM 7.1ch	DTS	DTS-HD
Linear PCM 2ch	PCM 2ch	PCM 2ch	DTS	Linear PCM 2ch
Linear PCM 5.1ch	PCM 2ch	PCM 5.1ch	DTS	Linear PCM 5.1ch
Linear PCM 7.1ch	PCM 2ch	PCM 7.1ch	DTS	Linear PCM 7.1ch

*1 The secondary and interactive audio may not be included in the output bitstream if [Digital Output] or [HDMI] option is set to [Primary Pass-Thru]. (Except LPCM Codec : the output always includes interactive and secondary audio.)

*2 This player automatically selects the HDMI audio according to the decoding capability of the connected HDMI device even though [HDMI] option is set to [Primary Pass-Thru].

*3 The [PCM Multi-CH]/[Primary Pass-Thru] setting of the [HDMI] option and [DTS re-encode] setting of the [Digital Output] option cannot be set together. If you set them together, the [HDMI] or [Digital Output] option is set to [PCM Stereo] automatically.

*4 On the PCM audio output, the sampling frequency of DIGITAL AUDIO OUT is limited to 96 kHz.

- *5 If the [HDMI] or [Digital Output] option is set to [DTS re-encode], the audio output is limited to 48 kHz and 5.1Ch. If the [HDMI] or [Digital Output] option is set to [DTS re-encode], the DTS Re-encode audio is output for BD-ROM discs, and the original audio is output for the other discs (like [Primary Pass-Thru]).
- If [HDMI] option is set to [PCM Multi-CH] and [Digital Output] option is set to [Primary Pass-Thru], it plays Dolby Digital Plus.
 - If the HDMI connection is version 1.3 and Dolby Digital Plus/Dolby TrueHD is output from HDMI OUT jack.
 - The audio is outputted as PCM 48 kHz/ 16 bit for MP3/WMA file and PCM 44.1 kHz/16 bit for Audio CD while playback.
 - The Dolby TrueHD audio recorded on some Blu-ray discs consists of Dolby Digital and TrueHD audio. Dolby Digital audio is output through DIGITAL AUDIO OUT jacks and “DD” displays on the screen if TrueHD audio is not output (for example, when [HDMI] is set to [PCM Stereo] and [Digital Output] is set to [Primary Pass-Thru]).
 - You must select a digital audio output and a maximum sampling frequency that your Amplifier (or AV receiver) accepts using [Digital Output], [HDMI] and [Sampling Freq.] options on the [Setup] menu (see page 33-34).
 - With digital audio connection (DIGITAL AUDIO OUT or HDMI), Disc Menu button sounds of BD-ROM may not be heard if the [Digital Output] or [HDMI] option is set to [Primary Pass-Thru].
 - If the audio format of the digital output does not match the capabilities of your receiver, the receiver will produce a strong, distorted sound or no sound at all.
 - Multi-channel Digital Surround Sound via digital connection can only be obtained if your receiver is equipped with a Digital Multi-channel decoder.

About the internal hard disk drive

The internal hard disk drive (HDD) is a fragile piece of equipment. Please use the player following the guidelines below to protect against possible HDD failure.

- Do not move the player while it is on.
- Install and use a player on a stable, levelled surface.
- Do not use the player in excessively hot or humid places, or in places that may be subject to sudden changes in temperature. Sudden changes in temperature can cause condensation to form inside the player. This can be a cause of HDD failure.
- While the player is powered on, do not unplug from the wall socket or switch the electricity off from the breaker switch.
- Do not move the player immediately after switching it off. If you need to move the player, please follow the steps below:
 1. After the message “OFF” is shown in the display, wait at least two minutes.
 2. Unplug from the wall socket.
 3. Move the player.
- If there’s a power failure while the player is on, there is a chance that some data on the HDD will be lost.
- The HDD is very delicate. If used improperly or in an unsuitable environment, it is possible that the HDD will fail after a few years of use. Signs of problems include playback unexpectedly freezing and noticeable block noise (mosaic) in the picture.
- However, sometimes there will be no warning signs of HDD failure.
- If the HDD fails, playback of content will not be possible. In this case, contact the LG service center by following methods.
Web: <http://lgservice.com>
- The manufacturer disclaims responsibility for loss of data contained in internal HDD.
- There are some capacities in HDD reserved for the file system and timeshift.

Video Output Resolution

When the non-copy protected media is playing back

Video Out Resolution	HDMI OUT
576i	576p
576p	576p
720p	720p
1080i	1080i
1080p/24 Hz	1080p / 24 Hz
1080p / 50 Hz	1080p / 50 Hz

When the copy protected media is playing back

Video Out Resolution	HDMI OUT
576i	576p
576p	576p
720p	720p
1080i	1080i
1080p/24 Hz	1080p / 24 Hz
1080p / 50 Hz	1080p / 50 Hz

HDMI OUT connection

- For the 576i resolution setting, real output resolution of HDMI OUT will change to 576p.
- If you select a resolution manually and then connect the HDMI jack to TV and your TV does not accept it, the resolution setting is set to [Auto].
- If you select a resolution that your TV does not accept, the warning message will appear. After resolution change, if you cannot see the screen, please wait 20 seconds and the resolution will automatically revert back to the previous resolution.
- The 1080p video output frame rate may be automatically set to either 24Hz or 50Hz depending both on the capability and preference of the connected TV and based on the native video frame rate of the content on the BD-ROM disc.

Specifications

General	
Power requirements	AC 200-240 V, 50/60 Hz
Power consumption	40 W
Dimensions (W x H x D)	Approx. 430 x 50 x 299 mm without foot
Net Weight (Approx.)	3.10 kg
Operating temperature	5 °C to 35 °C
Operating humidity	5 % to 90 %
Television system:	DVB-T Standard Compliant

TV Recording	
Recording format	TS (Transport Stream format)
Recordable media	Hard Disk Drive (160 GB / 250 GB / 320 GB / 500 GB / 1 TB), USB 2.0 HDD
Audio recording format	Dolby Digital (2CH)

Connectors	
HDMI OUT (video/audio)	19 pin (HDMI standard, Type A)
OPTICAL (DIGITAL AUDIO OUT)	3 V (p-p), Optical jack x 1
ANTENNA IN	Antenna input, 75 Ω
USB Port	4 pin (USB 2.0 standard) x 2

System	
Laser	Semiconductor laser
wavelength	405 nm / 650 nm
Signal system	Standard PAL/NTSC colour TV system
Frequency response	20 Hz to 20 kHz (48 kHz, 96 kHz, 192 kHz sampling)
Signal-to-noise ratio	More than 100 dB (Analogue OUT connectors only)
Harmonic distortion	Less than 0.008%
Dynamic range	More than 95 dB
LAN port	Ethernet jack x 1, 10BASE-T/100BASE-TX
Wireless LAN (internal antenna)	Integrated IEEE 802.11n (Draft 2.0) wireless networking access, compatible with 802.11b/g Wi-Fi networks.
Bus Power Supply (USB)	DC 5 V  500 mA

- Design and specifications are subject to change without notice.

Maintenance

Notes on Discs

Handling Discs

Do not touch the playback side of the disc. Hold the disc by the edges so that fingerprints do not get on the surface. Never stick paper or tape on the disc.

Storing Discs

After playing, store the disc in its case. Do not expose the disc to direct sunlight or sources of heat and never leave it in a parked car exposed to direct sunlight.

Cleaning Discs

Fingerprints and dust on the disc can cause poor picture quality and sound distortion. Before playing, clean the disc with a clean cloth. Wipe the disc from the centre to out.

Do not use strong solvents such as alcohol, benzene, thinner, commercially available cleaners, or anti-static spray intended for older vinyl records.

Handling the Unit

When shipping the unit

Please save the original shipping carton and packing materials. If you need to ship the unit, for maximum protection, re-pack the unit as it was originally packed at the factory.

Keeping the exterior surfaces clean

- Do not use volatile liquids such as insecticide spray near the unit.
- Wiping with strong pressure may damage the surface.
- Do not leave rubber or plastic products in contact with the unit for a long period of time.

Cleaning the unit

To clean the player, use a soft, dry cloth. If the surfaces are extremely dirty, use a soft cloth lightly moistened with a mild detergent solution. Do not use strong solvents such as alcohol, benzene, or thinner, as these might damage the surface of the unit.

Maintaining the Unit

The unit is a high-tech, precision device. If the optical pick-up lens and disc drive parts are dirty or worn, the picture quality could be diminished. For details, please contact your nearest authorized service centre.

Important Information Relating to Network Services

All information, data, documents, communications, downloads, files, text, images, photographs, graphics, videos, webcasts, publications, tools, resources, software, code, programs, applets, widgets, applications, products and other content ("Content") and all services and offerings ("Services") provided or made available by or through any third party (each a "Service Provider") is the sole responsibility of the Service Provider from whom it originated.

The availability of and access to Content and Services furnished by the Service Provider through the LGE Device are subject to change at any time, without prior notice, including, but not limited to the suspension, removal or cessation of all or any part of the Content or Services.

Should you have any inquiry or problem related to the Content or Services, you may refer to the Service Provider's website for the most up-to-date information. LGE is neither responsible nor liable for customer service related to the Content and Services. Any question or request for service relating to the Content or Services should be made directly to the respective Content and Service Providers.

Please note that LGE is not responsible for any Content or Services provided by the Service Provider or any changes to, removal of, or cessation of such Content or Services and does not warrant or guaranty the availability of or access to such Content or Services.



Technology with the human touch
GUARANTEE

- LG Electronics U.K. Ltd. will provide the following services in order to expedite this Guarantee.
- 1. All faulty components which fail due to defective manufacture will be replaced free of charge for a period of 12 months from the original date of purchase.
- 2. The dealer (or his service agent) who sold the product will be reimbursed for any labour provided in the repair of this LG equipment, for a period of 12 months from the original date of purchase. These claims must be made in accordance with the published scale of service charges and relevant claims procedure.

PLEASE NOTE:

- A The dealer may restrict the guarantee to the original purchaser.
- B The dealer is not obliged to carry out service under guarantee if unauthorized modifications are made to the apparatus, or if non standard components are used or if the serial number of the apparatus is removed, defaced, misused, or altered.
- C Any claims made under guarantee must be directed to the dealer from whom the equipment was originally purchased. The dealer may, before carrying out service under guarantee, require a receipted account as evidence of the date of purchase.
- D We respectfully point out that your dealer is not obligated to replace batteries if they become exhausted or worn in use.
- E Aerial alignment and consumer control adjustments are not covered by this guarantee.

This guarantee does not affect your statutory rights.

- **REQUIREMENTS TO MAINTAIN WARRANTY COVERAGE:**
 RETAIN YOUR RECEIPT TO PROVE DATE OF PURCHASE. A COPY OF YOUR RECEIPT MUST BE SURRENDERED AT THE TIME GUARANTEE SERVICE IS PROVIDED.
- **Product Registration Card :**
 It is helpful to complete at least your name, address, phone, model & serial numbers and return it. This will enable LG to assist you in the future should you lose your receipt, your units be stolen, or should modifications be necessary.
- **To obtain information or assistance:** Call 0870 873 5454 Monday-Friday 9.00am-4.30pm

MODEL NO.*	SERIAL NO.*	DATE OF PURCHASE.*

In all cases of difficulty - consult your LG dealer from whom the product was purchased

LGEUK Website : www.lg.com
 (service website : www.lgservice.com)



Free Manuals Download Website

<http://myh66.com>

<http://usermanuals.us>

<http://www.somanuals.com>

<http://www.4manuals.cc>

<http://www.manual-lib.com>

<http://www.404manual.com>

<http://www.luxmanual.com>

<http://aubethermostatmanual.com>

Golf course search by state

<http://golfingnear.com>

Email search by domain

<http://emailbydomain.com>

Auto manuals search

<http://auto.somanuals.com>

TV manuals search

<http://tv.somanuals.com>