



22LY560M
28LY560M
32LY560M
42LY560M

Hospital TVs

Commercial Mode Setup Guide

Note: Selected features shown within this guide may not be available on all models.

EXPERIENCED INSTALLER

Express Script Installer Menu Wizard
pages 12 – 17

Custom Master TV Setup
pages 31 – 35

FTG Mode of Operation
pages 46 – 52

For Customer Support/Service, please call:
1-888-865-3026

The latest product information and documentation is available online at:
www.LGSolutions.com

MODEL and SERIAL NUMBER
The model and serial numbers of this TV are located on the back of the cabinet. For future reference, LG suggests that you record those numbers here:

Model No. _____ Serial No. _____



WARNING:

TO REDUCE THE RISK OF ELECTRIC SHOCK DO NOT REMOVE COVER (OR BACK). NO USER-SERVICEABLE PARTS INSIDE. REFER TO QUALIFIED SERVICE PERSONNEL.



The lightning flash with arrowhead symbol, within an equilateral triangle, is intended to alert the user to the presence of uninsulated “dangerous voltage” within the product’s enclosure that may be of sufficient magnitude to constitute a risk of electric shock to persons.



The exclamation point within an equilateral triangle is intended to alert the user to the presence of important operating and maintenance (servicing) instructions in the literature accompanying the appliance.

WARNING:

TO PREVENT FIRE OR SHOCK HAZARDS, DO NOT EXPOSE THIS PRODUCT TO RAIN OR MOISTURE.

POWER CORD POLARIZATION:

This product is equipped with a 3-wire grounding-type alternating current power plug. This plug will fit into the power outlet only one way. This is a safety feature. If you are unable to insert the plug fully into the outlet, contact your electrician to replace your obsolete outlet. Do not defeat the safety purpose of the 3-wire grounding-type plug.

NOTE TO CABLE/TV INSTALLER:

This reminder is provided to call the cable TV system installer’s attention to Article 820-40 of the National Electrical Code (U.S.A.). The code provides guidelines for proper grounding and, in particular, specifies that the cable ground shall be connected to the grounding system of the building, as close to the point of the cable entry as practical.

REGULATORY INFORMATION:

This equipment has been tested and found to comply with the limits for a Class B digital device, pursuant to Part 15 of the FCC Rules. These limits are designed to provide reasonable protection against harmful interference when the equipment is operated in a residential installation. This equipment generates, uses and can radiate radio frequency energy and, if not installed and used in accordance with the instruction manual, may cause harmful interference to radio communications. However, there is no guarantee that interference will not occur in a particular installation. If this equipment does cause harmful interference to radio or television reception, which can be determined by turning the equipment off and on, the user is encouraged to try to correct the interference by one or more of the following measures:

- Reorient or relocate the receiving antenna.
- Increase the separation between the equipment and receiver.
- Connect the equipment to an outlet on a circuit different from that to which the receiver is connected.
- Consult the dealer or an experienced radio/TV technician for help.

CAUTION:

Do not attempt to modify this product in any way without written authorization from LG Electronics U.S.A., Inc. Unauthorized modification could void the user’s authority to operate this product.

COMPLIANCE:

The responsible party for this product’s compliance is: LG Electronics U.S.A., Inc.
1000 Sylvan Avenue, Englewood Cliffs, NJ 07632, USA • Phone: 1-201-816-2000

Marketed and Distributed in the United States by LG Electronics U.S.A., Inc.
1000 Sylvan Avenue, Englewood Cliffs, NJ 07632

IMPORTANT SAFETY INSTRUCTIONS

1. Read these instructions.
2. Keep these instructions.
3. Heed all warnings.
4. Follow all instructions.
5. Do not use this apparatus near water.
6. Clean only with dry cloth.
7. Do not block any ventilation openings. Install in accordance with the manufacturer's instructions.
8. Do not install near any heat sources, such as radiators, heat registers, stoves, or other apparatus (including amplifiers) that produce heat.
9. Do not defeat the safety purpose of the polarized or grounding-type plug. A polarized plug has two blades with one wider than the other. A grounding-type plug has two blades and a third grounding prong. The wide blade or the third prong are provided for your safety. If the provided plug does not fit into your outlet, consult an electrician for replacement of the obsolete outlet.
10. Protect the power cord from being walked on or pinched, particularly at plugs, convenience receptacles, and the point where it exits from the apparatus.
11. Only use attachments/accessories specified by the manufacturer.
12. Use only with the cart, stand, tripod, bracket, or table specified by the manufacturer or sold with the apparatus. When a cart is used, use caution when moving the cart/apparatus combination in order to avoid injury from tip-over.



13. Refer all servicing to qualified service personnel. Servicing is required when the apparatus has been damaged in any way, such as power-supply cord or plug is damaged, liquid has been spilled or objects have fallen into the apparatus, the apparatus has been exposed to rain or moisture, does not operate normally, or has been dropped.
14. Never touch this apparatus or antenna during a thunder or lightning storm.
15. When mounting a TV on the wall, make sure not to install the TV by the hanging power and signal cables on the back of the TV.
16. Do not allow an impact shock or any objects to fall into the product, and do not drop objects onto the screen.

17. Power Cord

Caution: It is recommended that appliances be placed upon a dedicated circuit; that is, a single outlet circuit which powers only that appliance and has no additional outlets or branch circuits. Check the TV specifications.

Periodically examine the cord of your appliance, and if its appearance indicates damage or deterioration, unplug it, discontinue use of the appliance, and have the cord replaced with an exact replacement part by an authorized servicer. Protect the power cord from physical or mechanical abuse, such as twisting, kinking, or pinching or being closed in a door or walked upon. Pay particular attention to plugs, wall outlets, and the point where the cord exits the appliance.

Do not use a damaged or loose power cord. Be sure to grasp the plug when unplugging the power cord. Do not pull on the power cord to unplug the TV.

18. Overloading

Do not connect too many appliances to the same AC power outlet as this could result in fire or electric shock. Do not overload wall outlets. Overloaded wall outlets, loose or damaged wall outlets, extension cords, frayed power cords, or damaged or cracked wire insulation are dangerous. Any of these conditions could result in fire or electric shock.

19. Outdoor Use/Wet Location



Warning: To reduce the risk of fire or electrical shock, do not expose this product to rain, moisture or other liquids.

Do not touch the TV with wet hands. Do not install this product near flammable objects such as gasoline or candles or expose the TV to direct air conditioning.

Do not expose to dripping or splashing and do not place objects filled with liquids, such as vases, cups, etc., on or over the apparatus (e.g., on shelves above the unit).

20. Grounding

Ensure that you connect the earth ground wire to prevent possible electric shock (i.e., a TV with a three-prong grounded AC plug must be connected to a three-prong grounded AC outlet). If grounding methods are not possible, have a qualified electrician install a separate circuit breaker. Do not try to ground the unit by connecting it to telephone wires, lightning rods, or gas pipes.

21. Disconnect Device

The mains plug is the disconnecting device. The plug must remain readily operable.

As long as this unit is connected to the AC wall outlet, it is not disconnected from the AC power source even if you turn off this unit by SWITCH.

(Continued on next page)

IMPORTANT SAFETY INSTRUCTIONS

(Continued from previous page)

22. Outdoor Antenna Grounding

If an outside antenna or cable system is connected to the product, follow the precautions below.

An outdoor antenna system should not be located in the vicinity of overhead power lines or other electric light or power circuits or where it can come into contact with such power lines or circuits as death or serious injury can occur.

Be sure the antenna system is grounded so as to provide some protection against voltage surges and built-up static charges.

Article 810 of the National Electrical Code (NEC) in the U.S.A. provides information with respect to proper grounding of the mast and supporting structure, grounding of the lead-in wire to an antenna-discharge unit, size of grounding conductors, location of antenna-discharge unit, connection to grounding electrodes, and requirements for the grounding electrode.

Antenna Grounding According to NEC, ANSI/NFPA 70

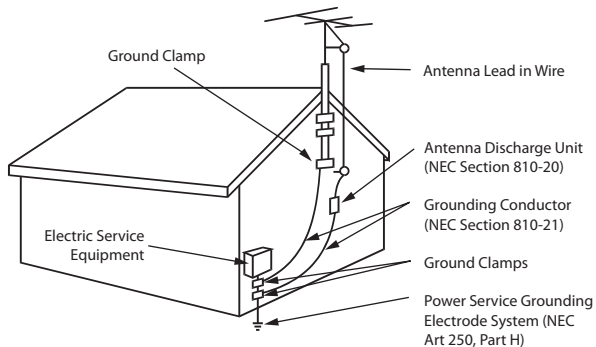

23. Cleaning

When cleaning, unplug the power cord and wipe gently with a soft cloth to prevent scratching. Do not spray water or other liquids directly on the TV as electric shock may occur. Do not clean with chemicals such as alcohol, thinners or benzene.

24. Transporting Product

Make sure the TV is turned Off and unplugged and that all cables have been removed. It may take two or more people to carry larger TVs. Do not press against or put stress on the front panel of the TV during transport.

25. Ventilation

Install the TV where there is proper ventilation. Do not install in a confined space such as a bookcase. Do not cover the TV with cloth or other materials (e.g., plastic) while it is plugged in. Do not install in excessively dusty places.

26. Do not touch the ventilation openings, as they may become hot while the TV is operating.
27. If you smell smoke or other odors coming from the TV or hear strange sounds, unplug the power cord, and contact an authorized service center.

28. Do not press against the front panel of the TV with your hand or a sharp object (e.g., a nail, pencil, or pen) or make a scratch on it.

29. Keep the product away from direct sunlight.

30. Dot Defect

The LCD panel is a high technology product with resolution of two million to six million pixels. In a very few cases, you could see fine dots on the screen while you are viewing the TV. Those dots are deactivated pixels and do not affect the performance and reliability of the TV.

31. Generated Sound

“Cracking”: A cracking noise that occurs while the TV is On or when it is turned Off is generated by plastic thermal contraction due to temperature and humidity. This noise is common for products where thermal deformation is required.

Electrical circuit humming/panel buzzing: A low level noise is generated from a high-speed switching circuit, which supplies a large amount of current to operate a product. It varies depending on the product. This generated sound does not affect the performance and reliability of the product.

32. For LCD TV

If the TV feels cold to the touch, there may be a small “flicker” when it is turned On. This is normal; there is nothing wrong with the TV. Some minute dot defects may be visible on the screen, appearing as tiny red, green, or blue spots. However, they have no adverse effect on the TV’s performance. Avoid touching the LCD screen or holding your finger(s) against it for long periods of time. Doing so may produce some temporary distortion effects on the screen.

Table of Contents

Safety Warnings	2	Learning FTG Configuration from a TV	50
Important Safety Instructions	3–4	Optional Manual Configuration / TV Setup	51
Table of Contents	5	FTG File Manager Utilities Overview	53–56
Commercial Mode Overview	6–9	FTG File Manager Main Screen	53
Setup Checklist	6	FTG Channel Map Configuration Utility	54
Pass-through Mode	6	FTG Channel Map Editor	55
FTG Mode	7	FTG Installer Menu Configuration Utility	56
Determining the TV Operating Mode	9	IP Environment Setup	57–60
Pro:Centric Operation	10–11	Accessing the IP Environment Menu	57
Pro:Centric Interactive Menu Features	10	Configuring the Network Connection	57
Pro:Centric Interactive Menu Navigation	10	Network Status	58
Pro:Centric Setup	11	Pro:Centric Setup	59
Express Script Installer Menu Wizard	12–17	References	
Before You Begin	12	Upgrading TV/PTC Software using a USB Memory	
Initiate Configuration or Exit the Express Script		Device	61
Installer Menu Wizard	12	Downloading a Splash Screen using a USB Memory	
Configure Pro:Centric Settings	13	Device	62
Complete the TV Configuration	14	Power Consumption Settings	63
Ez Download Utility	18–20	TV Aux Input Configuration	64
Before You Begin	18	Auto Input(s) Sensing Feature	65–66
Accessing and Using the Ez Download Utility	18	LY560M Hospital Operations	67–68
Installer Menu	21–30	Restoring Factory Defaults on the TV(s)	69
Accessing the Installer Menu	21	Using the TV Zoning Feature	70–71
Using the Installer Menu	22	22/28LY560M Rear and Side Jack Panels	72
Exiting the Installer Menu and Activating Settings	22	32/42LY560M Rear and Side Jack Panels	73
Custom Master TV Setup	31–35	External Stereo Speaker Setup	74
Before You Begin	31	Installer Remote Control Typical Key Functions	75
Cloning Methods	31	Pillow Speaker Setup	76
Clonable TV Setup Menu Features	31	USB Media Navigation using Pro:Centric Pillow Speaker	77
Custom Master TV Setup Procedure	32	VESA Standard TV Mounts	78
Channel Icons / Custom Text Labels		Troubleshooting	79–81
(2-5-4 + MENU Mode)	36	General Troubleshooting	79
Channel Banks Setup	37–39	Commercial Mode Check	80
Channel Banks Worksheet	40	Channel Banks Setup Troubleshooting	81
Cloning Procedures	41–45	Glossary of Terms	82
Cloning Overview	41	Document Revision History / Open Source Software Notice	83
Learning / Teaching a Master TV Setup using a TLX File	41	Back Cover	84
Learning / Teaching a Master TV Setup using a TLL File	44		
FTG Mode of Operation	46–52		
Creating an FTG Configuration File	46		
Teaching FTG Configuration to a TV	48		

Notes

- Installer Menu content is intended for use primarily by qualified TV electronics technicians.
- Refer to the Owner's Manual for additional information on TV installation, features, specifications, maintenance, and safety instructions.
- Design and specifications subject to change without prior notice. This document provides examples of typical TV displays. Your displays may vary from those shown in this document.

Commercial Mode Overview

This document describes how to set up LY560M Pro:Centric® TVs for Commercial Mode operation. LG commercial TV functionality is based on “ownership” of the Channel Map; that is, the Channel Map resides in the TV’s CPU or Protocol Translator Card (PTC) or it resides externally from the TV (i.e., in a device from the solution provider).

These TV models are capable of Free-To-Guest (FTG) Mode operation via the TV CPU. Alternatively, the TV can be configured for Pass-through Mode (default). When in Pass-through Mode, these TV models also allow external control via the TV’s MPI port.

Setup Checklist

Note: This document provides information specific to Commercial Mode operation. Refer to the Owner’s Manual for detailed information on TV installation and hardware and cable connections.

Installation

- Unpack TV and all accessories.
 - Install batteries in the Installer Remote.
 - Install TV on VESA mount or stand.
- Note:** It may be advisable to make all cable connections before installing on VESA mount or stand, as appropriate.

Cable Connections

- Make all rear jack panel connections, as appropriate.

Commercial Mode Setup

- Complete appropriate procedures as described in this document for Commercial Mode operation.

Hardware Connections

- Install any additional hardware as appropriate to your institution, LAN, etc.

Pass-through Mode

This mode allows you to configure individual TVs for Pro:Centric and/or FTG Mode operation or create a Master TV Setup for cloning purposes. This mode also allows external control via the MPI port on the TV rear jack panel.

There are two methods for configuring stand-alone TVs in Pass-through Mode: either using the Express Script Installer Menu Wizard or the Custom Master TV Setup procedure as described in this document.

Express Script Installer Menu Wizard

The Express Script Installer Menu Wizard guides you through the process of setting up a TV that is in a factory default state. Its customization of TV features and Installer Menu items is limited to those that are essential to most hospital TV viewing applications. See “Express Script Installer Menu Wizard” on pages 12 to 17 for detailed information.

Note: While the Express Script Installer Menu Wizard enables you to set up TVs in lieu of cloning, you can also use an Express Script TV Setup for TLL cloning purposes, if desired. However, note that TV setup menu customization via the Express Script Installer Menu Wizard is limited to Channel Menu options.

Custom Master TV Setup

Unlike the guided process above, the Custom Master TV Setup procedure enables you to create a customized Master TV Setup for cloning purposes for TVs that are to remain in Pass-through Mode. Use the Installer Remote to configure Installer Menu items as required for TV operation and set up TV features (Channel, Picture, Audio, etc.). See “Custom Master TV Setup” on pages 31 to 35 for detailed information.

Commercial Mode Overview (Cont.)

Installer Menu

To create a customized Master TV Setup, you will need to know how to access the commercial controller (PTC) Installer Menu and make changes to the default values as required. If necessary, familiarize yourself with the Installer Menu and how to make and save changes. Refer to pages 21 to 30 for information on accessing the Installer Menu and for detailed descriptions of the Installer Menu items.

TV Setup Menus

On-screen setup menus control the features of the TV. Use the Installer Remote to access the TV setup menus, and set the TV features to the desired configuration for the end user.

Cloning

Cloning refers to the process of capturing a Master TV Setup and transferring it to a Target TV. Both TVs must be in Pass-through Mode and both TVs must be identical models. The Master TV's clonable setup menu features should be configured as part of the Master TV Setup. If there are features in the Master TV's setup—channel icons or labels, digital font options, etc.—that are not set or that are set incorrectly, those features also will not be set or will be set incorrectly in the Target TVs. Refer to pages 41 to 45 for detailed information on cloning requirements and procedures.

Note: If desired, an Express Script TV Setup also may be used for TLL cloning purposes.

External MPI Control

To control the TV using an external MPI control device, you must use the TV's MPI port for communication purposes.

Note: These TV models are not equipped with MPI card slots.

FTG Mode

In this mode, the TV's CPU is configured with an FTG Channel Map, and the CPU controls and restricts the tuning operation of the TV based on this FTG Channel Map. The FTG Channel Map enables the decryption of each Pro:Idiom[®] encrypted channel and also provides logical channel mapping of physical RF channels (analog and digital) and Aux inputs. In addition, in these models, FTG Mode provides the option to select either logical or physical tuning during configuration (refer to "Teaching FTG Configuration to a TV" on pages 48 to 49 and also see note below).

Note: Logical channel mapping of physical RF channels eliminates dash tuning (for example, physical 19-3 can be mapped to logical channel 9). Physical channel tuning requires that you include the dash when direct entering channel numbers.

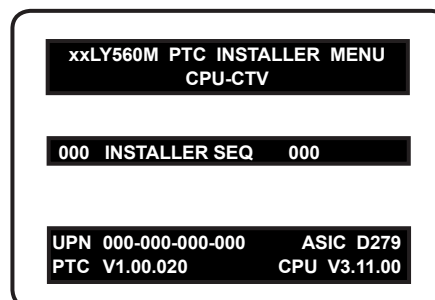

Typical Installer Menu

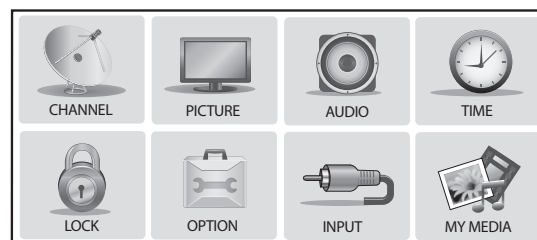

TV Setup Menus

Commercial Mode Overview (Cont.)

FTG Mode Features

FTG Mode provides the following features:

- Logical or physical tuning of physical RF channels and Aux inputs.
- Mapping of RF channels with minor (program) numbers up to 999.
- FTG Channel Map of up to 600 channels.
- Start Channel set for RF or Aux input delivered content.
- Pro:Centric data delivery over RF or IP.
- TV Zoning option for location-specific configuration.

LG's FTG File Manager PC software enables you to create an FTG Configuration (.tlx) file, which may be used to configure the CPU for FTG Mode. FTG File Manager utilities enable you to create/edit an FTG Channel Map and configure Installer Menu settings. You can also save (Learn) a TLX file from a Master TV.

In this mode, the TV's CPU must be configured with an FTG Channel Map and FTG Installer Menu settings using one of the following processes:

- Local: Configure an individual LY560M TV via its USB port using a USB memory device / TLX file. The "Teach to TV (TLX)" process and associated procedures for FTG Mode configuration are described on pages 46 to 52.
- Remote: Configure all LY560M TVs at the site using a Pro:Centric server head end device (Example: PCS150R). Load a TLX file on the Pro:Centric server using the TV E-Z Installation "Configuration" option in the Pro:Centric server Admin Client. Refer to the **Pro:Centric Server Admin Client User Guide** for further information.

While the TV is in FTG Mode:

- Users can still access the Installer Menu using an LG Installer Remote; however, all Installer Menu items will be read-only.
- Any FTG configuration changes must be made using a TLX file (typically edited in the FTG File Manager). The FTG File Manager's FTG Channel Map Configuration and FTG Installer Menu Configuration Utilities enable you to make changes, respectively, to the FTG Channel Map and FTG Installer Menu settings as necessary. See information on local configuration in this document or refer to documentation for the server for information on remote management.
- If it becomes necessary to restore the TV to Pass-through Mode, there are several options that will enable you to do so. See Reference section, "Restoring Factory Defaults on the TV(s)," for further information.

Pages 53 to 56 provide overviews of the utilities that comprise the FTG File Manager. Refer to the **Free-To-Guest (FTG) File Manager User Guide** for further information on the FTG File Manager.

Remote Management in FTG Mode

When the TV is configured for FTG Mode, remote management of the FTG Channel Map and FTG Installer Menu settings is provided by a Pro:Centric server, via a TLX file loaded on the Pro:Centric server Admin Client. Refer to the **Pro:Centric Server Admin Client User Guide** for further information.

Determining the TV Operating Mode

To determine the operating mode of the TV, press **MENU** on the Installer Remote. The menu displayed depends on the operating mode. See examples below.

If the Function Menu appears, the TV is in a mode (FTG, PPV, etc.) that does not allow the end user to change the fundamental TV setup. If the TV setup menus appear, the TV is in Pass-through Mode.

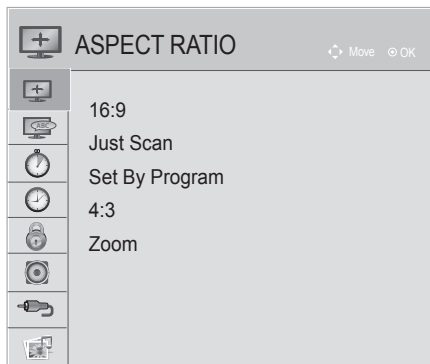

Function Menu

Indicates the TV is not in Pass-through Mode. While the TV is in this mode, Installer Menu settings can be accessed as read-only.

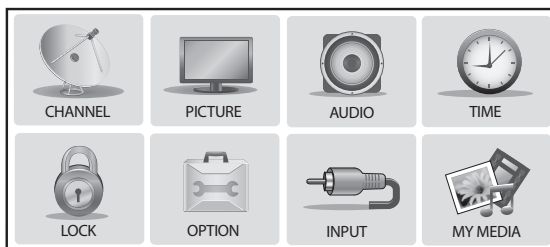

TV Setup Menus

Shows that the TV is in Pass-through Mode.

Pro:Centric Operation

Pro:Centric Interactive Menu Features

LG's Pro:Centric application enables patients and visitors to locate and select television entertainment using an interactive channel guide, check the daily weather, and view hospital and surrounding amenities via custom billboards and points-of-interest maps.

Pro:Centric application features include:

- Portal and information screens/pages (including a "Welcome" page) that include branding logos.
- An optional customized user interface (custom "skins").
- Billboards and points-of-interest maps, which can be customized to focus on hospital amenities, local attractions and businesses, hotels, restaurants, news, events, etc.
- An optional Weather billboard that includes a local radar map, current conditions, and a four day forecast.
- An interactive channel guide that provides a channel list with channel icons. An electronic program guide (EPG) is an optional feature that displays up to three days of programming information viewable by channel and time.
- Video spooling that enables the hospital to deliver a video file to patient and visitor TVs for promotion and information purposes.

The Pro:Centric server Admin Client web editor/content wizard is provided for customer configuration of portal messages and billboards/maps.

Note: Customized content is typically defined by the service integrator and/or hospital administrators. LG does not provide hospital-specific content.

Pro:Centric Interactive Menu Navigation

LG's Pro:Centric pillow speaker provides access to both interactive menus and regular TV features. Press **PORTAL** on the Pro:Centric pillow speaker to access the interactive menus.

Note: Interactive menu options may vary, depending on Pro:Centric features enabled for the site. The following are default interactive menus.



Channel Guide

Shows available TV networks and logical channels. When available, EPG data provides additional channel and program information.

Information

Typically displays information on hospital and nearby amenities, for example, restaurants, cafeterias, facilities, etc., as well as information on local weather.

Help

Provides help for navigating the interactive menus.

Watch TV

Removes the interactive menu from the screen and returns to the previously tuned TV channel.

Pro:Centric Setup

Administration and management options for the Pro:Centric server are described in detail in the *Pro:Centric Server Admin Client User Guide*. This document describes only those settings that must be specified on the TVs to enable the Pro:Centric remote management facilities and/or the Pro:Centric application.

- Remote management (TV E-Z Installation): The Pro:Centric server Admin Client provides remote management facilities for downloading splash screens and software/firmware updates as well as facilities for downloading FTG Channel Map and FTG Installer Menu settings for FTG Mode configuration.
- Pro:Centric application: The application, which operates in conjunction with FTG and PPV Modes, comprises the Pro:Centric interactive menus/features described on the previous page. Pro:Centric application settings are managed via the Pro:Centric server Admin Client.

The Pro:Centric server settings can be configured using one of the following methods:

- When the TV is in a factory default state, the Express Script Installer Menu Wizard provides an option for configuring the Pro:Centric server settings. Refer to “Express Script Installer Menu Wizard” on pages 12 to 17 for further information.
 - If the TV is in Pass-through Mode, either:
 - Set Installer Menu items 098 PRO:CENTRIC and 119 DATA CHANNEL to the appropriate values. Refer to “Installer Menu” information on pages 21 to 30 for further details. Also, as necessary, refer to “Custom Master TV Setup” information on pages 31 to 35 and/or cloning information on pages 41 to 45.
 - Configure the appropriate Pro:Centric server settings in the IP Environment / Pro:Centric Menu. You must use this option, in particular, if you wish to configure IP settings for the Pro:Centric server. See “Accessing the IP Environment Menu” on page 57 and “Pro:Centric Setup” on page 59 for further information.
- Note:** When the TV is in either Pass-through Mode or FTG Mode, you can also leave Installer Menu item 119 DATA CHANNEL set to its default value (255) to enable the TV’s Data Channel Auto Search feature to set the DATA CHANNEL value. See item 119 description on page 30 for additional information.
- If the TV is in FTG Mode, use the FTG File Manager to update the Pro:Centric and Data Channel Installer Menu items (along with their affiliated fields). Then transfer the FTG Installer Menu settings to the TV. Refer to the FTG Mode overview on pages 7 to 8 for further information on FTG Mode operation and configuration. Also, see note above regarding the option to use the TV’s Data Channel Auto Search feature to set the DATA CHANNEL value.

Note: If using a Pro:Centric pillow speaker, also set Installer Menu item 027 HOSPITAL MODE to the required value.

Express Script Installer Menu Wizard

The Express Script Installer Menu Wizard guides you through the process of setting up the essential items for most hospital TV viewing applications and also enables you to configure the Pro:Centric settings on the TV. The wizard will appear on the screen each time the TV is turned ON, until configuration is completed or the wizard is exited. Use the Installer Remote to make selections and complete each wizard step.

Before You Begin

- If you plan to create a customized Master TV Setup using the procedure described on pages 31 to 35 or use a TLX file for cloning or FTG Mode configuration purposes, be sure to exit the Express Script in order to avoid setup conflicts that may cause the TV to malfunction. The Express Script Installer Menu Wizard is intended for individual TV setup or TLL cloning only.
- If it has been completed or exited and therefore does not display, the Express Script Installer Menu Wizard can be reactivated; however, this requires that you perform an “IN-STOP” to restore factory defaults on the TV(s). See Reference section, “Restoring Factory Defaults on the TV(s),” for further information.

 **Caution: Do NOT unplug the TV power cord or remove the antenna cable or, if applicable, the LAN cable during the configuration process, as doing so may interrupt the current step and/or corrupt the configuration data.**

Initiate Configuration or Exit the Express Script Installer Menu Wizard

 **Note: If you bypass the Express Script, pillow speaker functionality will not be enabled unless you set Installer Menu item 027 HOSPITAL MODE appropriately. See the “Installer Menu” section of this document for further information.**

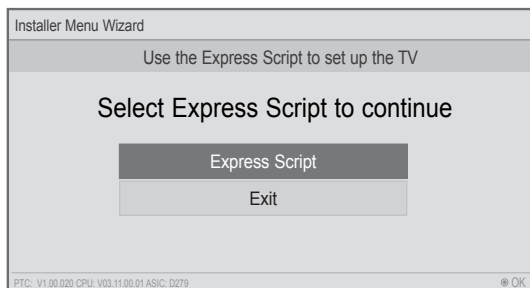

From the Express Script launch screen, you have the following options:

- To proceed with the Express Script Installer Menu Wizard, use the Up/Down arrow keys on the Installer Remote to select/highlight **Express Script**. Then, press **OK** on the Installer Remote.

Note: You can select the “Express Script” option if you want to configure Pro:Centric settings on this TV, even if you do not intend to complete the TV configuration using the Express Script. After you configure the Pro:Centric settings, you will have the option to exit the remainder of the wizard, if desired.

- To exit the wizard without completing any configuration, use the Up/Down arrow keys on the Installer Remote to select/highlight **Exit** and press **OK**. In the confirmation pop-up window, select **OK**, and then press **OK** once more on the Installer Remote.

Express Script Installer Menu Wizard (Cont.)

Configure Pro:Centric Settings

The next wizard screen enables you to set up the Pro:Centric feature of the TV. By default, the Data Channel is configured for Auto Search, which enables the TV's Data Channel Auto Search feature to set the Data Channel value. See item 119 DATA CHANNEL description on page 30 for further information on the Data Channel Auto Search feature. The Pro:Centric Mode default setting is "Configuration Only," which enables remote management only. That is, the TV will search for TV E-Z Installation data downloads; however, Pro:Centric application data will not be downloaded, i.e., Installer Menu item 098 PRO:CENTRIC will be set to 0.

If you wish to proceed with the wizard without changing the default values for the Pro:Centric settings, you can simply select **Next** and press **OK** on the Installer Remote. Or, if you wish to exit the wizard while retaining the default values for Pro:Centric settings, use the arrow keys on the Installer Remote to select **Done**, and then press **OK**.

If you already know the Pro:Centric settings that need to be configured in order for the TV to connect to the Pro:Centric server and/or if the Pro:Centric server is not yet installed, follow the procedure below to expedite the setup process. Use the Up/Down arrow keys on the Installer Remote to navigate between the fields.

Note: If you wish to disable the Pro:Centric feature of the TV, select the Data Channel field, and then use the Left/Right arrow keys on the Installer Remote to select **Disabled**. From here, you may opt to proceed with the wizard (select **Next**) or save this setting and exit the wizard (select **Done**). See also step 3 below.

1. Refer to the appropriate subsection below, depending on the Pro:Centric server configuration, to complete the Media Type and related (Data Channel or IP) fields.

RF Configuration

- a) In the Media Type field, use the Left/Right arrow keys on the Installer Remote to select **RF**.
- b) In the Data Channel field, either key in or use the Left/Right arrow keys to select the RF channel number that will be used by the Pro:Centric server as its data channel. The Data Channel value can be set from 1 to 135.*

IP Configuration

- a) In the Media Type field, use the Left/Right arrow keys on the Installer Remote to select **IP**.
Note: By default, the Pro:Centric wizard screen initially shows RF configuration fields. When you select "IP" as the Media Type, the Data Channel field is replaced with (IP) Address and Port fields.
- b) In the Address and Port fields, either key in or use the Left/Right arrow keys to select the appropriate values for the Pro:Centric server IP address and port number.

The IP address must match the IPv4 multicast address and the port number must match the port number that is set in the Pro:Centric server.

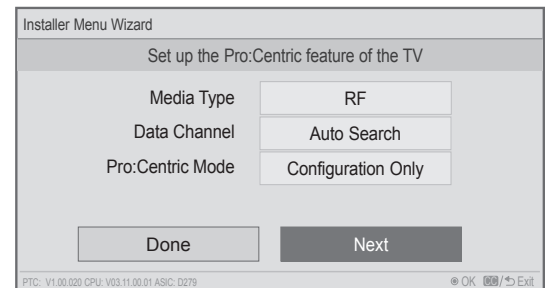

Pro:Centric Configuration Screen with RF Media Fields

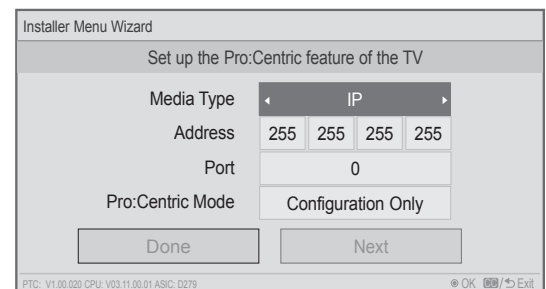

Pro:Centric Configuration Screen with IP Media Fields

(Continued on next page)

* PCS150R and later Pro:Centric servers do not support HRC or IRC cable channel frequencies.

Express Script Installer Menu Wizard (Cont.)

(Continued from previous page)

2. In the Pro:Centric Mode field, use the Left/Right arrow keys on the Installer Remote to select the appropriate Pro:Centric Application Mode—GEM, FLASH, or Configuration Only.
3. Once the fields are completed as required, you have two options:
 - To proceed with TV configuration via the wizard, select **Next** and press **OK** on the Installer Remote. See also “Complete the TV Configuration” below.
 - To save the data entered and exit the wizard, select **Done** and press **OK** on the Installer Remote. Remember, however, that if you bypass the Express Script, pillow speaker functionality will not be enabled unless you set Installer Menu item 027 HOSPITAL MODE appropriately. See the “Installer Menu” section of this document for further information.

 **Note: If you intend to use a TLX file for cloning or FTG Mode configuration purposes, exit the Express Script at this time.**

Complete the TV Configuration

The following procedure describes the remaining Express Script Installer Menu Wizard steps. You can select the “Back” button, where available, to check previous settings, as necessary.

 **Note: If you choose to exit the Express Script from this point on, any settings made will not be retained.**

1. Select the tuning band.

Use the Up/Down arrow keys on the Installer Remote to select the tuning band field, and then use the Left/Right arrow keys to select the appropriate tuning band: Cable Standard (default), Cable HRC, Cable IRC, or Air. When you have made your selection, use the arrow keys to select **Next**, and then press **OK**.

2. Select the Aux inputs.

If you simply select **Next** and press **OK** in this step, default values will be used, i.e., all Aux inputs will be enabled. Otherwise, use the Up/Down arrow keys on the Installer Remote to select the desired Aux input option(s).

Note: If an Aux input will not be used, it is advisable to disable it. After the TV setup is transferred to the PTC (see step 8), the only way to remove Aux inputs from the channel lineup, is to go to the Channel Preview/Banks Setup Menu and select Normal-Deleted.

- To customize settings, select **Customize Inputs** and press **OK**. Aux input options are displayed in a pop-up window. Use the arrow keys to select the input(s) to enable or disable. When you are finished, press **OK** on the Installer Remote. Then, continue with step 3.

Note: If you would like to return to the Aux Input screen, press **MENU** to close the pop-up window.

- To use default values, select **Use Default Values** and press **OK**. Then, continue with step 3.

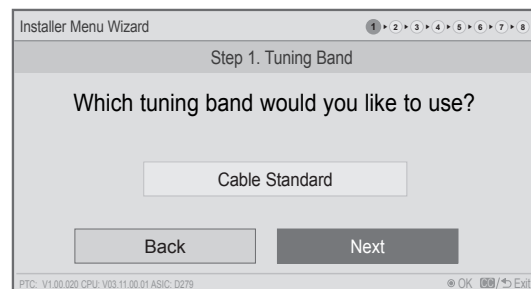

Note: Typically, if you do not modify the default settings, the “Next” option is automatically selected when you proceed forward within the wizard. Where appropriate, you can simply press **OK** on the Installer Remote to proceed to the next step if the default value(s) for the TV parameter(s) in question are applicable for your installation.

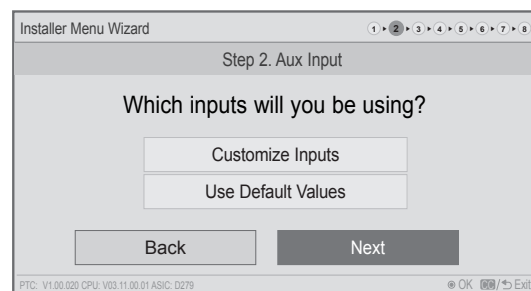

(Continued on next page)

Express Script Installer Menu Wizard (Cont.)

(Continued from previous page)

3. Select the speaker configuration.

Use the Up/Down arrow keys on the Installer Remote to select the speaker configuration field, and then use the Left/Right arrow keys to select the appropriate speaker: Pillow Only (default), TV Only, or Pillow & TV. When you have made your selection, use the arrow keys to select **Next**, and then press **OK**.

4. Select the pillow speaker code.

If using a Pro:Centric pillow speaker (LG IR codes) or a pillow speaker with Zenith IR codes, you can simply select **Next** and press **OK** on the Installer Remote to accept the Zenith pillow speaker code default.

Otherwise, use the Up/Down arrow keys on the Installer Remote to select the pillow speaker code field, and use the Left/Right arrow keys to select the appropriate option. When you have made your selection, use the arrow keys to select **Next**, and then press **OK**.

5. Choose whether to allow access to channels outside the channel lineup.

To allow direct access to channels outside the channel lineup (default: Yes), you can simply select **Next** and press **OK** on the Installer Remote. To limit access to only the channel lineup (after the Express Script is complete) and restrict access to the TV setup menus, use the Up/Down arrow keys on the Installer Remote to select the channel access field, and then use the Left/Right arrow keys to select "No."

When you have made your selection, use the arrow keys to select **Next**, and then press **OK**.

Note: It is recommended that you select "No" to limit access to the channel lineup and prevent end users from accessing channel settings; i.e., the Channel Menu will be inaccessible/grayed out.

6. Run the Auto Search (Auto Tuning).

Select **Execute Auto Search** and press **OK** on the Installer Remote to start the channel scan (searches for all available analog and digital channels). The system will display progress of the channel scan in a pop-up window. The scan typically takes a few minutes.

When the channel scan is complete, press **OK** on the Installer Remote to close the pop-up window. Then, continue with step 7.

Note: If you do not want to run the Auto Search (for example, if you intend to manually add only a small number of channels), use the arrow keys on the Installer Remote to select **Next**, and then press **OK**. Then, continue with step 7.

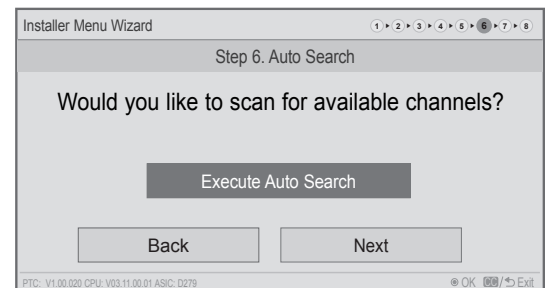
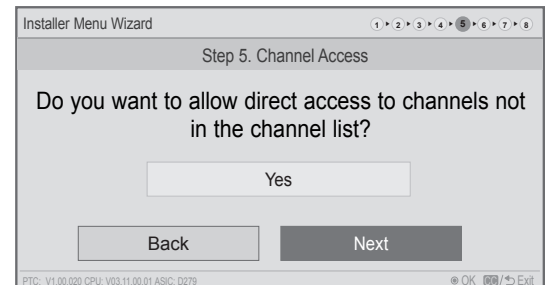
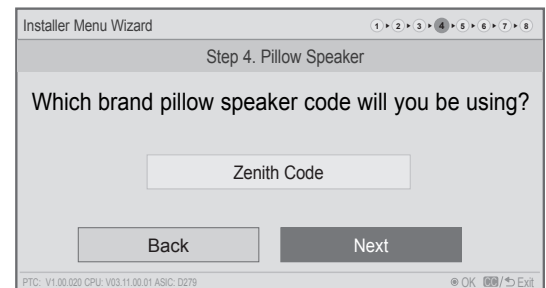

(Continued on next page)

Express Script Installer Menu Wizard (Cont.)

(Continued from previous page)

 **Note: You MUST select Execute Auto Search and press OK in order to run the channel scan. If you move on to the next step without running the Auto Search, there will be no analog or digital channels in the channel lineup (Channel Map). In this case, upon completion of the Express Script, the only channels in the resulting PTC Channel Map will be any enabled Aux inputs.**

7. Edit the Channel Map.

This option enables you to add/delete channels, select channel icons, add channel labels, and/or set up channel banks before the Channel Map is transferred to the commercial controller (PTC) in step 8.

 **Note: The maximum number of channels (analog, digital, and Aux inputs) that can be transferred to the PTC is 141. An attempt to transfer more than 141 channels of any combination will result in a PTC Channel Map of exactly 141 channels; any extra channels will not be available in the PTC Channel Map. For example, if you enabled three Aux inputs in step 2 and Auto Tuning found 141 channels, you must edit the Channel Map to decrease the number of analog/digital channels to (at most) 138 in order to accommodate the Aux inputs in the PTC Channel Map. Note that Aux inputs will appear between the highest analog and lowest digital channel number in the PTC Channel Map.**

Select **Edit Channel Map** and press **OK** on the Installer Remote to edit the Channel Map, as necessary. Channel edit options will be displayed in a pop-up window (see example at right). Use the Up/Down arrow keys to navigate between fields:

- **CH \ Input:** Edit the channel lineup, as necessary, to include only free to guest (non-encrypted) channels. Use the Left/Right arrow keys on the Installer Remote to select channels, and press **OK** to add/delete channels per your system requirements.
- **Icon:** Use the Left/Right arrow keys or key in the icon number to select the appropriate trademark/icon for each channel's Channel-Time on-screen display. Icons are available for familiar channels, such as ABC, CBS, NBC, etc. Identifiable icons should enable the end user to readily know what common networks are available.
- **Label:** Press **OK** to display the alphanumeric keypad, and add custom text labels for each channel, as desired. Added custom labels will be displayed above the Label/Keypad field for each channel, as applicable.
- **Bank:** Use the arrow keys to define channel banks, as desired. See pages 37 to 40 for further information on channel banks.

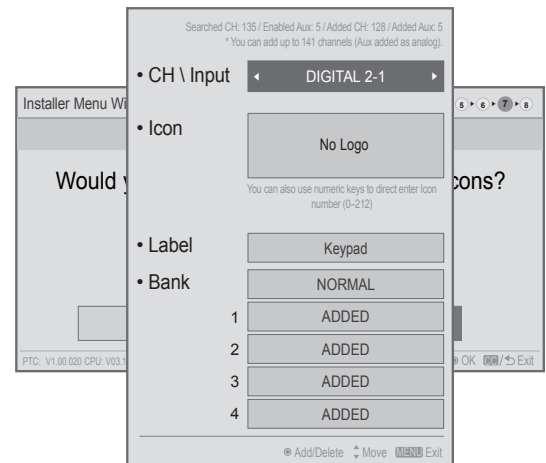
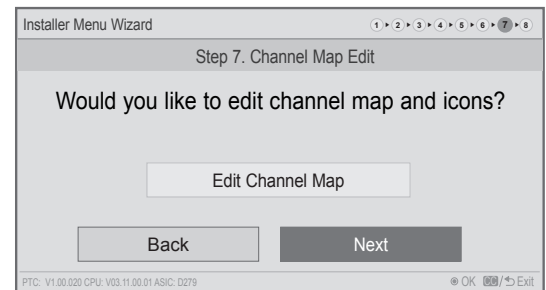

Note: The total number of channels found (“Searched”) during Auto Tuning is indicated at the top of the display.

(Continued on next page)

Express Script Installer Menu Wizard (Cont.)

(Continued from previous page)

When you are finished, press **MENU** to close the pop-up window. Use the arrow keys to select **Next**, and then press **OK**.

8. Completion.

In the final step, the TV saves your settings and transfers the setup to the commercial controller (PTC). (This is similar to 2-5-5 + MENU Mode during Custom Master TV Setup.) When this step is complete, the Express Script Installer Menu Wizard closes.

Note: If desired, you can save the TV Setup created using the Express Script to a USB memory device / TLL file for transfer to Target TVs. See “Learning / Teaching a Master TV Setup using a TLL File” on pages 44 to 45.

Note: If access to the channel lineup has been limited at the completion of the Express Script (see step 5) and you would like to set up channel banks at a later time, you will need to set Installer Menu item 028 CH. OVERRIDE to 1 to enable access to the Channel Preview/Banks Setup Menu. See pages 37 to 40 for further information on channel banks.

Note: You can also edit/add channel icons and/or custom text labels in 2-5-4 + MENU Mode after the Express Script is completed, if necessary. See page 36 for further information.

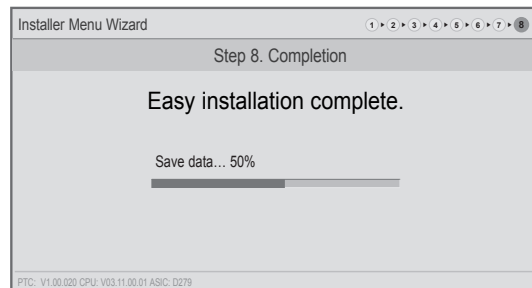

Ez Download Utility

The Ez Download utility, available from the TV Manager / USB Download Menu, enables you to select multiple files at one time from the files loaded on a USB memory device. You may use this utility to download any one or all of the following to a TV: a TLX file for configuration purposes, a TLL file for cloning purposes (legacy), a TV CPU or PTC software update, a splash screen image.

Before You Begin

- Ensure the USB device has been formatted with FAT format.
- Software upgrade and splash image files must be stored in a folder named “LG_DTV” in the root directory of the USB memory device. TLX and TLL files should simply be stored in the root directory of the USB device.
- If the TV is currently in Pass-through Mode and you intend to use the TV Zoning feature for location-specific configuration purposes, make sure to assign the appropriate TV Zone # in the TV when directed to do so in the procedure below.
- Refer to “Custom Master TV Setup” on pages 31 to 35 for information on creating a TLX or TLL file for cloning purposes, and/or refer to “Creating an FTG Configuration File” on pages 46 to 47 for information on creating an FTG Configuration (.tlx) file for FTG Mode configuration.
- See Reference section, “Downloading a Splash Screen using a USB Memory Device,” for splash screen image guidelines.
- See Reference section, “Upgrading TV/PTC Software using a USB Memory Device,” for further information on software upgrades.



Caution: Do not unplug the TV power cord or remove the USB memory device during a data download, as doing so may cause the TV to malfunction or harm the USB device, respectively.

Accessing and Using the Ez Download Utility

1. If it is not ON already, turn ON the TV.

If the Express Script Installer Menu Wizard appears on the screen when you turn ON the TV, exit the wizard. Then, continue with step 2.

2. If the TV is currently in Pass-through Mode, you are transferring (Teaching) a TLX file to the TV as part of the Ez Download, and you intend to use the TV Zoning feature, assign the appropriate TV Zone # in the TV at this time. See Reference section, “Using the TV Zoning Feature,” for further information.



Note: In order for the proper location-specific TV Zone profile data to be applied, the Zone designation must be assigned in the Target TV(s) BEFORE you continue with Ez Download.

3. Insert the USB memory device that contains the appropriate file(s) into the TV’s USB port.

(Continued on next page)



(Continued from previous page)

4. To access the TV Manager / USB Download Menu from the TV menus:
 - Press **MENU** on the Installer Remote to display the TV setup menus (TV is in Pass-through Mode) or the Function Menu (TV is not in Pass-through Mode).
 - Use the arrow navigation keys to select/highlight either the **Option** menu icon from the TV setup menus or the **Lock** menu icon from the Function Menu. Then, press the number “7” key a total of seven times.
5. With the TV Manager / USB Download Menu on display (see example at right), use the Up/Down arrow keys to select **Ez Download**, and then press **OK**.
6. The Ez Download window contains a listing of the CPU (EPK), PTC, and splash image (LOGO) files stored in the LG_DTV folder and the TLX and TLL files stored in the root directory on the USB device.

To select or de-select a file, respectively, use the Up/Down arrows on the Installer Remote to highlight the filename, and press **OK** to add or remove the checkmark at the left of the filename.

Note: The utility will only allow you to select one of each file type for downloading. For example, if there are two TLX files in the Ez Download list, you can only select one or the other of those two files.

Note: After an Ez Download is run, a file is created on the USB device, which maintains a history of the files previously used for Ez Download. The next time(s) you use this USB device for Ez Download, the files you selected for the previous download will be pre-selected by default.

7. The fields at the right of the screen will change depending on the currently highlighted file. Select the appropriate option(s) for each file, as applicable:
 - For software and splash image files: The fields at the right of the screen show the TV software versions and any available Forced Update options. Do not select any Forced Update options unless you have been specifically instructed to do so or have previous experience with Expert Software Updates.
 - For TLX files: If an FTG Channel Map is included in the TLX file, a Channel Tuning / Channel Banner Display field at the right of the screen enables you to select the format for the channel tuning/banner display. Press the green  button on the Installer Remote to select **Logical** tuning, or press the yellow  button on the Installer Remote to select **Physical** tuning. A checkmark will appear at the left of the selected option. Logical tuning is selected by default.

Note: If a TLX file does not include an FTG Channel Map, the message, “No Channel Map in TLX file,” will be displayed at the right of the screen.

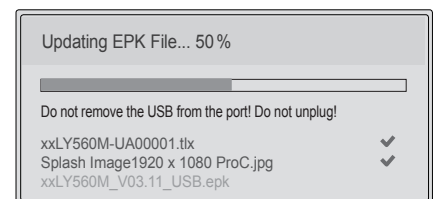
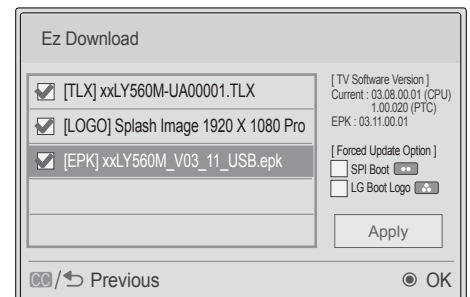
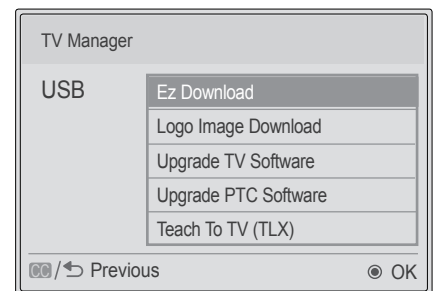

(Continued on next page)

Ez Download Utility (Cont.)

(Continued from previous page)

Note: There are no options available/applicable for TLL files.

Note: Press **↵** on the Installer Remote, as necessary, to exit the Ez Download screen and/or the TV Manager / USB Download Menu and return to TV viewing.

8. When you are ready to continue, use the arrow keys on the Installer Remote to select **Apply**, and then press **OK**.

The TV will show download progress in a new window. Do NOT remove the USB device until downloading is complete. When the download is complete, the TV will briefly display an overview of the results in a "Complete" window and then return to TV viewing or reboot (the latter if software has just been downloaded).

9. Remove the USB memory device, and verify that the appropriate configuration is resident on the TV.

Note: (TLX configuration only) When configuration is complete, the TV tunes according to the Start Channel setting in the Installer Menu. If a Start Channel is specified, the TV will tune to that channel, though in the case of FTG Mode configuration, a channel banner will only be displayed if the Start Channel is included in the FTG Channel Map (depending on your selection in step 7, the channel banner will display either the Start Channel's logical channel number or physical RF channel number). Otherwise, the TV will either return to the last channel tuned (TV in Pass-through Mode) or tune to the first channel in the FTG Channel Map (TV in FTG Mode). If the latter, remember that the channels in the FTG Channel Map are always arranged in logical order, regardless of your selection in step 7.

Use the Installer Menu to set up, change, or view operational settings. This section describes how to access, use, and exit the Installer Menu from the TV itself. However, you should also refer to the Installer Menu descriptions in this document if you are configuring the TV using an FTG Configuration (.tlx) file created using LG's FTG File Manager software.

Refer to the table on pages 23 and 24 for brief descriptions of Installer Menu items. More detailed descriptions follow the table listing.

Accessing the Installer Menu

1. Turn ON the TV.

If the Express Script Installer Menu Wizard appears on the screen when you turn ON the TV, exit the wizard.

2. Using an Installer Remote, press **MENU** repeatedly until the on-screen display of the TV setup menus (if the TV is in Pass-through Mode) or the Function Menu (if the TV is not in Pass-through Mode) no longer toggles, and then press the Installer Menu entry sequence (e.g., **9-8-7-6**) + **OK** to access the Installer Menu.

Note: The default Installer Menu entry sequence is "9876"; however, if Installer Menu item 000 INSTALLER SEQUENCE has been modified, the entry sequence may be one of three additional options. See Installer Menu detailed descriptions for further information.

The Installer Menu opens with item 000 INSTALLER SEQ 000.

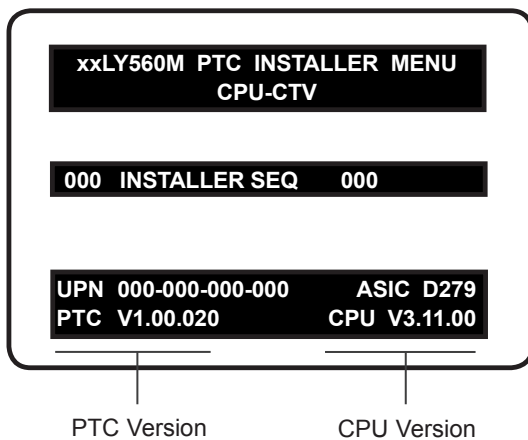

Typical Installer Menu

The Installer Menu header will vary depending on the TV you are setting up. In the Installer Menu footer, you can see the current software versions of the TV, as indicated.

Note: If the password (entry sequence) is not entered or registered correctly, you will see the message "ENTER PASSWORD 0000" at the top of the screen instead of the Installer Menu header. Once you re-enter the correct password (e.g., press 9-8-7-6 + OK), the Installer Menu will display.

Note: If the TV is not in Pass-through Mode, the Installer Menu is accessible as read-only. Also, the TV Zone # will be indicated in the Installer Menu header under the configuration mode indicator described on the following page.

Installer Menu (Cont.)

As part of the Installer Menu header (in all modes), two 3-character acronyms are displayed to indicate the TV's current configuration mode. The table below lists all possible mode identifiers for these TV models.

Acronym	Description
CPU-CTV	Pass-through Mode with Channel Map in CPU
CPU-FTG	FTG Mode via CPU
CPU-P:C	Application Tuning Mode via CPU
MPI-EXT	External MPI Control
PTC-CTV	Pass-through Mode with Channel Map in PTC

Using the Installer Menu

Refer to the table starting on the next page for an overview of the available Installer Menu items, including their item numbers, functions, value ranges, and default values.

Installer Menu items not relevant to these TV models are not present in the Installer Menu; therefore, some numbers are missing. For example, item 006 will not appear. In addition, items that are dependent on other Installer Menu item settings will not be initially accessible. For example, item 046 STRT AUX SRCE will not display in the Installer Menu unless item 004 STRT CHANNEL is set to 0. See Installer Menu detailed descriptions for further information.

Navigation within the Installer Menu

Use the Up/Down arrow keys on the Installer Remote to sequence through the available menu items, or access an item directly by keying in the item number and then pressing **MENU**. For example, to access the SLEEP TIMER option, which is item 015, press 0-1-5 + MENU.

Changing Installer Menu Settings

To change an Installer Menu item value, use the Left/Right arrow keys on the Installer Remote, or enter a valid value directly. To save the new setting, press **OK**, or use the Up/Down arrow keys to navigate to a new Installer Menu item if you have additional items to edit. Note that invalid values will not be saved.

Exiting the Installer Menu and Activating Settings

After you have adjusted all Installer Menu item settings as required, press **OK** once on the Installer Remote to save your changes; then, press **OK** again to exit the Installer Menu. Any changes you make will be stored in non-volatile memory.

Note: Each time you exit the Installer Menu in Pass-through Mode, all V-Chip (Parental Control) settings in the TV are reset to their default values; that is, the Lock System, if previously enabled from the Lock setup menu, will now be disabled, and the individual Parental Control settings will be restored to default values.



Caution: Installer Menu settings may affect options available from the TV setup menus or the Function Menu.

Installer Menu (Cont.)

Installer Menu Items 000 through 047

Item	Function	Value Range	Default Value	Brief Description of Function
000	INSTALLER SEQ	0 ~ 3	0	Leave default set to 0.
001	POWER MANAGE	0 ~ 7	0	Sets number of hours of no activity before automatic shutoff.
002	AC ON	0 / 1	0	Set to 1 to enable TV to turn ON when AC power is applied.
003	BAND/AFC	0 ~ 3	1	Selects Tuning Band: 0=Broadcast, 1=CATV, 2=HRC, 3=IRC
004	STRT CHANNEL	0 ~ 127, 255	255	Channel tuned when TV is turned ON. (Set to 255 to tune to channel tuned before TV turned OFF.)
005	CHAN LOCK	0 / 1	0	If set to 1, cannot tune from current channel.
007	STRT VOLUME	0 ~ 63, 255	255	Volume level when TV is turned ON. (Set to 255 to use volume level before TV turned OFF.)
008	MIN VOLUME	0 ~ 63	0	Sets minimum allowable volume setting.
009	MAX VOLUME	0 ~ 63	63	Sets maximum allowable volume setting.
010	MUTE DISABLE	0 / 1	0	Set to 1 to disable Mute Function.
011	KEY DEFEAT	0 / 1	1	If set to 1, joystick button menu navigation functions on display panel are not available.
012	IR BANKS EN.	0 / 1	0	Set to 1 to enable TV to respond to bank discrete IR codes.
013	SCAN MODE	0 / 1	1	Set to 1 to allow Channel Up/Down to turn ON TV. (See detailed descriptions.)
014	STRT CH IN SM	0 / 1	0	Set to 1 to use the Start Channel for the Channel Map pivot point in Scan Mode.
015	SLEEP TIMER	0 / 1	1	Set to 1 to enable Sleep Timer.
016	EN TIMER	0 / 1	1	Set to 1 to enable On/Off Timers.
017	ALARM	0 / 1	1	Set to 1 to enable Alarm.
020	FEATURE LEVEL	0 ~ 1, 16 ~ 24, 64 ~ 65	1	Determines an additional IR code scheme to which the TV will respond.
021	V-CHIP	0 / 1	1	Set to 1 to enable V-Chip (Parental Control) functions.
022	MAX BLK HRS	0 ~ 99	12	Sets number of V-Chip blocking hours.
023	CAPTION LOCK	0 / 1	0	Set to 1 to retain caption setting before TV turned Off.
025	FUNCTION PRE.	0 ~ 1	1	Set to 1 to allow Channel Preview/Banks Setup Menu access via CH PREVIEW key on Installer Remote.
027	HOSPITAL MODE	0 ~ 162, 254	254	Set according to the speaker selection, the pillow speaker code/supply voltage, and the hospital IR code. See detailed instructions.
028	CH. OVERRIDE	0 / 1	1	If set to 0, user access to channel settings in the TV setup menus is restricted and users can only tune to channels that are included in the channel lineup.
029	OLD OCV	0 / 1	0	Set to 1 to remap the PTC's direct tune channels for Aux inputs from 13x to 9x.
030	ACK MASK	0 / 1	0	If set to 1, enables ACK feature of MPI.
031	POLL RATE	20 ~ 169	94	Selects poll rate for MPI.
032	TIMING PULSE	186 ~ 227	207	Sets baud rate for MPI.
035	HDMI1 ENABLE	0 ~ 2	1	Set to 0 to disable HDMI 1. Set to 1 (DTV Mode) or 2 (PC Mode), as applicable, to enable HDMI 1.
039	REAR AUX EN	0 / 1	1	Set to 1 to enable display panel Video 1 input jack.
041	SIMPLINK EN	0 ~ 3	0	Determines the status of the SIMPLINK feature. (See detailed descriptions.)
042	AUTO INPUTS	0 ~ 255	0	Determines the Aux inputs for which auto-sensing is enabled. (See detailed descriptions.)
046	STRT AUX SRCE	1, 3 ~ 5, 255	255	Sets the starting Aux source (if item 004 STRT CHANNEL is set to 0).
047	AUX STATUS	0 / 1	0	Set to 1 for MPI Aux source to be reported as a channel number instead of Channel 0.

Installer Menu (Cont.)

Installer Menu Items 053 through 122

Item	Function	Value Range	Default Value	Brief Description of Function
053	DIS. CH-TIME	0 / 1	0	Set to 1 to disable Channel-Time display.
069	EN. CH-T COL.	0 / 1	1	Set to 1 to enable custom color for the Channel-Time display.
070	FOR. CH-TIME	0 ~ 7	2	Chooses custom foreground color for the Channel-Time display.
071	BCK. CH-TIME	0 ~ 7	2	Chooses custom background color for the Channel-Time display.
073	CH NOT AVBLE	0 / 1	0	If set to 1 and item 028 CH. OVERRIDE is set to 0, a "CHANNEL NOT AVAILABLE" message is displayed if user attempts to direct tune a channel that is not included in the channel lineup.
075	REVERT CH	0 / 1	0	If set to 1 and loss of MPI communication occurs, TV tunes to Start Channel.
077	QUICK SHUTOFF	0 ~ 17	0	Allows TV to be turned OFF with press and hold of pillow speaker channel buttons. Set to 0 to disable. Set from 1 to 17 to define hold time. (See detailed descriptions.)
078	UPN MSB	0 ~ 255	255	User programmable number, most significant byte.
079	UPN MSB-1	0 ~ 255	255	User programmable number, most significant byte - 1.
080	UPN MSB-2	0 ~ 255	255	User programmable number, most significant byte - 2.
081	UPN LSB	0 ~ 255	255	User programmable number, least significant byte.
082	CHKSM ERROR	0 / 1	1	If set to 1, enforces rigid MPI checksum.
083	HANDSHK TIME	0 ~ 5	5	Relaxes MPI timing to be compatible with PC-based Windows-controlled systems.
084	PERMANENT BLK	0 / 1	0	Removes block hours setting for Parental Control and makes block permanent.
087	REAR RGB EN.	0, 1, 17	1	Set to 0 to disable RGB input. Set to 1 to enable RGB input. Set to 17 for Auto Configure.
088	EN NOISE MUTE	0 / 1	1	(Analog channels only) If set to 1, audio is muted if no signal is present.
090	KEY LOCK	0 / 1	0	If set to 1, all display panel joystick button functions are locked. IR is still functional.
091	HDMI2 ENABLE	0 ~ 2	1	Set to 0 to disable HDMI 2. Set to 1 (DTV Mode) or 2 (PC Mode), as applicable, to enable HDMI 2.
094	SAP MENU EN	0 / 1	1	Set to 0 to disable feature on Function Menu. Set to 1 to enable feature on Function Menu.
096	DEF. ASP. RATIO	0 ~ 4	2	Sets default aspect ratio at power up. See detailed descriptions and item 106.
097	AUDIO OUTPUT	0 ~ 9	7	Set as required in accordance with external audio equipment connected to the TV. See detailed descriptions.
098	PRO:CENTRIC	0 ~ 2	0	Set to 0 to disable Pro:Centric operation. Set to 1 for Flash Mode. Set to 2 for GEM (Java Application) Mode.
099	BACK LIGHTING	1 ~ 202, 255 *	255	Sets the level of the TV picture back lighting. (See detailed descriptions.)
102	ATSC BAND	0 ~ 4	4	Selects ATSC band.
103	ATSC TUNE MODE	0 / 1	1	Set to 1 (default) for Physical Channel scan. Set to 0 for Virtual Channel scan.
104	START MINOR CH	0 ~ 255	0	Selects Minor Start Channel. Set to 0 for NTSC.
106	ASP RATIO LOCK	0 / 1	0	To retain set aspect ratio on power cycle, set to 1. Set to 0 for default ratio on power cycle.
116	VIDEO MUTE EN	0 / 1	0	(Analog channels only) If set to 1, video mutes (blank screen) when no signal is present.
117	FACT DEFAULT	0 / 1	0	Set to 1 to restore the factory default settings of all Installer Menu items.
119	DATA CHANNEL	0 ~ 135, 253, 255	255	Set to 0 to disable. Set from 1 to 135 to match the RF channel number used by the Pro:Centric server as its data channel. Set to 255 to use Auto Search to find the Pro:Centric RF channel. (See detailed descriptions.)
121	UPDATE TIME HR	0 ~ 23, 128	128	Sets the Wake For Update hour. The value "128" is displayed as "OFF." Directly entering 128 turns the Wake For Update feature OFF.
122	UPDATE TIME MN	0 ~ 59	0	Sets the minute for Wake For Update.

* Values 201, 202 applicable for 32/42LY560M only.

Detailed Descriptions of Installer Menu Items

000 - INSTALLER SEQUENCE

Specifies entry sequence to the Installer Menu.

0 = 9876 1 = 4321
2 = 1478 3 = 3698

001 - POWER MANAGE (Power Management)

Determines hours of no activity before automatic shutoff. The Power Management function is for saving energy. If set to 0, Power Management is Off. Settings range from 0 ~ 7, with 1 ~ 7 representing the hours that the unit will remain ON, unless there has been activity from either the control panel or remote control.

002 - AC ON (AC Power Switchable)

If set to 1, this allows the TV to turn ON when AC power is applied. Pressing the POWER button is not necessary. This is desirable if the TV is plugged into a switched AC outlet (i.e., a set-top box). Set to 0 (default) for standard TV turn ON/OFF operation.

Note: If set to 1, the TV does not respond to ON/OFF commands from either the remote or the display panel, and the SLEEP TIMER is also nonfunctional.

003 - BAND/AFC (Band/Automatic Frequency Control)

There are four possible settings for this option:

0 = Broadcast 1 = CATV (default)
2 = HRC 3 = IRC

If some channels were not found by Auto Tuning (Channel Search), select the appropriate Band setting here, and add the channels using the Channel Edit option in the Channel Menu.

004 - STRT CHANNEL (Start Channel)

If active, this function allows you to determine the initial Major Start Channel number when the TV is turned ON. This feature is useful for an in-house information channel, since the TV would always select that channel when it is turned ON. If set to 255, the last channel tuned before the TV was turned OFF will be the channel tuned when the TV is turned ON again.

0 = Aux 127 = Map to Major CH 4
1 ~ 125 = Major CH # 255 = Last Channel
126 = Map to Major CH 3

Note: For a digital Start Channel, always remember to set item 104 to the Minor Start Channel number.

Note: 126 and 127 are mapped only in SONIFI PPV Mode.

005 - CHAN LOCK (Channel Lock)

Channel Lock is ideal if the system must always be on the same channel. Changing channels with the Channel Up/Down or keypad numbers is impossible. Channel Lock is inactive if set to 0 (default).

Generally, this feature is used in connection with item 004 STRT CHANNEL where the Start Channel may, for example, be set to 3 or 4. If the Start Channel is 3, then the TV will remain locked on channel 3.

NOTE: For items 007, 008, and 009

For legacy reasons, the scale used is 0 - 63. The PTC software will translate this to the 0 - 100 scale used by the TV.

To translate a TV volume level to the Installer Menu value, use the following formula:

$$\text{Installer Value} = \frac{\text{TV Value} \times 63}{100}$$

Enter only the whole number (disregard fractions).

007 - STRT VOLUME (Start Volume)

This function allows the Installer to determine the initial volume level setting when the TV is turned ON. This feature is useful for an in-house information channel, since the TV will always select that volume level when it is turned ON. The range of values is 0 to 63, 255. If set to 255, the last volume level before the TV was turned OFF will be the current volume level when the TV is turned ON again.

008 - MIN VOLUME (Minimum Volume)

This function determines the minimum volume level allowable with the Volume (VOL) Up/Down control. In this way, for example, someone cannot set the volume too low to hear. The value range is from 0 to 63. The factory default is 0, which provides the full range of volume control, if item 009 MAX VOLUME is set to 63. It is recommended to set the same value on every TV.

Note: The minimum volume level cannot have a value setting higher than the maximum volume level (described below).

009 - MAX VOLUME (Maximum Volume)

This function determines the maximum volume level allowable with the Volume (VOL) Up/Down controls. In this way, for example, someone cannot set the volume level high enough to disturb others. The value range is 0 to 63, with 63 as the default, which gives the user the full range of volume control, if item 008 MIN VOLUME is set to 0. It is recommended to set the same value on every TV.

Note: The maximum volume level cannot have a value setting lower than the minimum volume level (described above).

010 - MUTE DISABLE

Enables or disables sound mute function. If set to 1, sound cannot be muted. If set to 0, sound can be muted.

011 - KEY DEFEAT

If set to 1, Key Defeat is enabled, which means that end users cannot access or navigate within the on-screen menu(s) from the display panel; i.e., joystick button menu navigation functions will not be available. Set to 0 to disable Key Defeat. Note that all IR features remain functional regardless of this setting.

Note: Users can always access the menus by pressing MENU on the remote.

Installer Menu (Cont.)

012 - IR BANKS EN (IR Banks Enable)

For direct access to a particular channel bank. When enabled, you can access a channel bank by inputting the discrete IR code for that bank.

Note: This item is not available in the Installer Menu when item 027 HOSPITAL MODE is set to 0.

013 - SCAN MODE (Functional after 2-5-5 + MENU transfer of Channel Map)

When set to 1 (default), allows TV to be turned ON when Channel Up/Down buttons are pressed on pillow speaker. Also, TV will turn OFF when Channel Up/Down key is used to tune above or below Channel Map pivot point. By default, Channel Map pivot point is between the highest and lowest channel in the Channel Map (also see item 014 STRT CH IN SM). Set to 0 to disable.

014 - STRT CH IN SM (Start Channel in Scan Mode)

Only valid when item 013 SCAN MODE is set to 1 (enabled). When set to 1, forces Channel Map pivot point to be between the RF channel designated in item 004 STRT CHANNEL and next lower channel in the Channel Map. Set to 0 to disable (default).

Note: This item is not available in the Installer Menu when item 013 SCAN MODE is set to 0.

015 - SLEEP TIMER

If set to 1, the Sleep Timer feature may be used. If set to 0, the Sleep Timer is not available.

016 - EN TIMER (Enable On/Off Timers)

If set to 1, the Timer function is available to the end user and enabled continuously. Set to 0 to disable On/Off timers.

Note: The TV clock must be set in order for timers to be used.

017 - ALARM

Gives the installer the option of making the Alarm function available to the end user. If set to 1, the Alarm function is available to the end user. Set to 0 to disable the Alarm function.

Note: The TV clock must be set before the Alarm function will work.

020 - FEATURE LEVEL

This function determines an additional IR code scheme to which the TV will respond, allowing for the use of unique IR codes based on "bed number" in a multi-TV single room installation. First determine the IR mode; then select the bed number.

Note: Item 027 HOSPITAL MODE must be set to 0 to enable Legacy Zenith Bed 1 or Bed 2 IR codes and Speaker selections.

Values	IR Mode	Bed #	Speaker
0–1	Legacy Zenith (Hospital)	1–2	TV
16–24	Multi-code Remote	1–9	TV
64–65	Legacy Zenith (Hospital)	1–2	Pillow

Note: For further information, see documentation for the accessory package that includes the multi-code remote.

021 - V-CHIP (Parental Control)

Set to 1 to activate V-Chip (Parental Control) and have it available to the end user to filter and control or otherwise restrict programming content that can appear. Set to 0 to turn the V-Chip feature Off (not available to user); no programming restrictions can be set.

022 - MAX BLK HRS (Maximum Block Hours)

Sets hours from 0 to 99 for the maximum V-Chip (Parental Control) block hours. Default setting is for 12 blocking hours.

Note: This item is not available in the Installer Menu when item 084 PERMANENT BLK is set to 1.

023 - CAPTION LOCK

If set to 0, captions are OFF when the TV is turned ON. Set to 1 to use the caption setting configured before the TV was turned OFF when the TV is turned ON.

025 - FUNCTION PRE (Function Preview)

Set to 1 to allow access to the Channel Preview/Banks Setup Menu via the CH PREVIEW key on Installer Remote. Set to 0 to disable access to the Channel Preview/Banks Setup Menu.

027 - HOSPITAL MODE

Set according to the speaker selection, the pillow speaker code/ supply voltage and the hospital IR code. If using a Pro:Centric pillow speaker, select one of the Zenith codes in accordance with the desired speaker selection. See table below.

Value	Speaker	Pillow Speaker Code/Voltage	Hospital IR Code
000	Determined by item 020 setting	Zenith (+12v)	Determined by item 020 setting
001	Pillow Only	Zenith (+12v)	Zenith Bed #1
002	Pillow Only	Zenith (+12v)	Zenith Bed #2
017	Pillow Only	Philips (+5v)	Zenith Bed #1
018	Pillow Only	Philips (+5v)	Zenith Bed #2
033	Pillow Only	RCA (-5v)	Zenith Bed #1
034	Pillow Only	RCA (-5v)	Zenith Bed #2
065	TV Only	Zenith (+12v)	Zenith Bed #1
066	TV Only	Zenith (+12v)	Zenith Bed #2
081	TV Only	Philips (+5v)	Zenith Bed #1
082	TV Only	Philips (+5v)	Zenith Bed #2
097	TV Only	RCA (-5v)	Zenith Bed #1
098	TV Only	RCA (-5v)	Zenith Bed #2
129	Both Pillow & TV	Zenith (+12v)	Zenith Bed #1
130	Both Pillow & TV	Zenith (+12v)	Zenith Bed #2
145	Both Pillow & TV	Philips (+5v)	Zenith Bed #1
146	Both Pillow & TV	Philips (+5v)	Zenith Bed #2
161	Both Pillow & TV	RCA (-5v)	Zenith Bed #1
162	Both Pillow & TV	RCA (-5v)	Zenith Bed #2
254	TV Only	Disabled (0v)	Zenith Bed #2

When Hospital Mode is enabled and the TV is in Pass-through Mode, channel banks are also available. Refer to channel banks information in this document for further details.

Channel banks are not supported if Hospital Mode is set to 0 or on TVs that are configured for FTG Mode operation.

When Hospital Mode is set to 0 (disabled), both the IR code that will control the TV and the speaker selection depend on the Installer Menu item 020 FEATURE LEVEL setting.

Note: The default setting (254) is not selectable in the Installer Menu. If you ever need to restore the default setting, you must set item 117 FACT DEFAULT to 1 to reload the factory default settings. See item 117 description for further information.

Note: In the Installer Menu, an informational code is displayed at the right of each Hospital Mode value. Each code consists of three characters. The first character—T, P, or B—identifies the speaker: TV, Pillow, or Both. The second character—Z, P, R, or D—identifies the pillow speaker code: Zenith, Philips, RCA, or Disabled. The third character—1 or 2—identifies the bed number. In the table on the previous page, each bolded character represents an element of the Hospital Mode code.

028 - CH. OVERRIDE (Channel Override)

Applicable for Pass-through Mode only. If set to 1, users can select channels either with Channel Up/Down or by direct keypad entry. This setting also allows full access to channel settings in the TV setup menus (i.e., channels may be added or removed from the channel lineup, channel labels and icons may be edited, etc.). If set to 0, the channel lineup is locked. That is, user access to channel settings in the TV setup menus is restricted, and users can only tune to the channels that are included in the channel lineup. Also, in this case, if the channel lineup has not been transferred to the PTC (via 2-5-5 + MENU Mode, as described in the Master TV Setup procedure) users can only select channels using Channel Up/Down; direct keypad entry is not available.

029 - OLD OCV (On Command Video™)

Set to 1 to remap the PTC's direct tune channels for Aux inputs from 13x to 9x. This allows 2-digit only tuning systems (i.e., legacy OCV) to direct tune Aux inputs. See also Reference section, "TV Aux Input Configuration."

030 - ACK MASK

MPI Communication Parameter. When set to 1, enables ACK feature of MPI.

031 - POLL RATE

MPI Communication Parameter. Selects poll rate for MPI. Step size of 16 ms. Changing from default may affect communication via MPI.

032 - TIMING PULSE

MPI Communication Parameter. Sets baud rate for MPI. Step size of 4.3 uS. Changing from default may affect communication via MPI.

035 - HDMI1 ENABLE

Set to 1 to enable HDMI 1 input in DTV Mode. Set to 2 to enable HDMI 1 input in PC Mode. Set to 0 to disable display panel HDMI 1 input.

039 - REAR AUX EN. (Rear Aux Enable)

Set to 1 to enable display panel rear Aux (Video 1) input. Set to 0 to disable display panel rear Aux (Video 1) input.

041 - SIMPLINK EN

Set to 0 to disable the SIMPLINK feature. Set to 1 to enable SIMPLINK functionality without enabling remote control access to the SIMPLINK Menu. Set to 2 to enable both SIMPLINK functionality and SIMPLINK Menu access, though note that the Speaker menu option will be inaccessible/grayed out. Set to 3 to enable all aspects of SIMPLINK feature and SIMPLINK Menu. If a home theater device is connected to the TV, users can select either the TV or HT (home theater) speaker.

Note: When both this item *and* item 042 AUTO INPUTS are enabled in the Installer Menu, HDMI inputs will be detected by SIMPLINK, but the Auto Input(s) Sensing Feature will not function.

042 - AUTO INPUTS

Determines the Aux inputs for which auto-sensing is enabled. Set to 0 to disable auto-sensing for all available inputs. Set to 255 to enable auto-sensing for all available inputs. For information on options for individual input settings, refer to Reference section, "Auto Input(s) Sensing Feature."

Note: In order for auto-sensing to be enabled for an input, that input must also be enabled in the Installer Menu. For example, to enable auto-sensing for HDMI 1, item 035 HDMI1 ENABLE must also be set to 1 or 2. Also, see note above regarding TV operation when both this item and item 041 SIMPLINK EN are enabled.

046 - STRT AUX SRCE (Start Aux Source)

Sets the starting Aux source. When turned ON, the TV will tune to starting Aux source if item 004 STRT CHANNEL is set to 0.

1 = Video 1 4 = RGB 255 = Last Aux
3 = HDMI 1 5 = HDMI 2

Note: Above is applicable only if all Aux sources are enabled.

Note: This item is not available in the Installer Menu unless item 004 STRT CHANNEL is set to 0.

047 - AUX STATUS

Set to 1 for MPI Aux source to be reported as a channel number instead of channel 0. Set to 0 to disable Aux identification change. Controls MPI status channel response for Aux inputs.

053 - DIS. CH-TIME (Disable Channel-Time)

Set to 1 to disable the Channel-Time display; Channel-Time display will not appear. Set to 0 to enable the Channel-Time display.

Installer Menu (Cont.)

069 - EN. CH-T COL. (Enable Channel-Time Custom Color)

Set to 1 to enable custom color for the Channel-Time display. Set to 0 to disable custom color for the Channel-Time display.

070 - FOR. CH-TIME (Channel-Time Display Foreground Color)

Set according to Color Chart:

0 = Black	3 = Cyan	6 = Yellow
1 = Blue	4 = Red	7 = White
2 = Green	5 = Violet	

Note: If foreground color and background color are the same, the menu background will be transparent.

Note: Applies only to “Channel Not Available” message if item 073 CH NOT AVBLE is set to 1 (enabled). Also, items 070 FOR. CH-TIME and 071 BCK. CH-TIME are not available in the Installer Menu when item 069 EN. CH-T COL. is set to 0.

071 - BCK. CH-TIME (Channel-Time Display Background Color)

See description for item 070 FOR. CH-TIME above. The color chart is the same for both items.

073 - CH NOT AVBLE (Channel Not Available)

If set to 1 and item 028 CH. OVERRIDE is set to 0, a “CHANNEL NOT AVAILABLE” message is displayed when a user attempts to direct tune a channel that is not included in the channel lineup.

Note: This item is not available in the Installer Menu when item 028 CH. OVERRIDE is set to 1.

075 - REVERT CH (Revert to Start Channel)

If set to 1 and loss of MPI communication occurs, TV automatically tunes to the specified Start Channel.

Note: This item is not available in the Installer Menu when item 004 STRT CHANNEL is set to 255.

077 - QUICK SHUTOFF

Allows end user (patient) to turn OFF TV using mechanical (analog) Pillow Speaker Channel Up/Down buttons. Patient needs to press and hold either channel button for time determined by value set. Set to 0 to disable. Set from 1 to 17 to establish required hold time of button—from 2 seconds to 10 seconds in half-second increments.

Note: This item is not available in the Installer Menu when item 013 SCAN MODE is set to 0.

078 - UPN MSB (UPN Most Significant Byte)

User programmable number, most significant byte readable by MPI command. Note: Not linked to serial number.

079 - UPN MSB-1 (UPN Most Significant Byte-1)

User programmable number, most significant byte-1 readable by MPI command. Note: Not linked to serial number.

080 - UPN MSB-2 (UPN Most Significant Byte-2)

User programmable number, most significant byte-2 readable by MPI command. Note: Not linked to serial number.

081 - UPN LSB (UPN Least Significant Byte)

User programmable number, least significant byte readable by MPI command. Note: Not linked to serial number.

082 - CHKSM ERROR (Checksum Error)

Enforces rigid MPI checksum validation. Set to 1 for validation. Set to 0 to disable (does not check checksum on MPI async port). SPI is always checked.

083 - HANDSHK TIME (Handshake Time)

Adds an additional delay to the handshake time which is 64 msec, thus relaxing MPI timing requirements to be compatible with PC-based Windows controlled systems. Range is 0 - 5. (Timeout = 25.5MS + [25.5 MS* Handshake time].)

084 - PERMANENT BLK (Permanent Block)

Allows Lock (Parental Control) blocking schemes to be permanent by disabling the blocking hours function. Set to 1 to install Parental Control restrictions permanently. Set to 0 for user-specified hours control of blocking schemes.

087 - REAR RGB EN. (Rear RGB Enable)

Controls access to rear RGB input on TV. Set to 0 to disable RGB input. Set to 1 to enable RGB input. Set to 17 to initiate a one-time automatic configuration after an AC power cycle; otherwise, automatic adjustment will be performed each time the RGB input is accessed.

088 - EN NOISE MUTE (Enable Noise Mute)

Applicable for analog channels only. If set to 1, audio mutes if no signal is present.

090 - KEY LOCK

If set to 1, Key Lock is enabled, which means that all display panel joystick button functions will be locked, i.e., non-functional. Set to 0 to disable Key Lock. Note that all IR features remain functional regardless of this setting.

091 - HDMI2 ENABLE

Set to 1 to enable HDMI 2 input in DTV Mode. Set to 2 to enable HDMI 2 input in PC Mode. Set to 0 to disable display panel HDMI 2 input.

094 - SAP MENU EN (2nd Audio Program)

Set to 1 to enable SAP feature on Function menu, if Function Menu is available (i.e., the TV is not in Pass-through Mode). Set to 0 to disable SAP feature on Function Menu, if Function Menu is available.

096 - DEF. ASP. RATIO (Default Aspect Ratio)

Selects default aspect ratio at power up:

- 0 = Set By System 1 = 4:3
 2 = 16:9 (default) 3 = Just Scan
 4 = Zoom

Note: This item is not available in the Installer Menu unless item 106 ASP RATIO LOCK is set to 0.

097 - AUDIO OUTPUT

Determines availability and signal type/level (fixed speaker, variable speaker, or fixed line level [amplifier]) of the audio output to be used by external audio equipment connected to the Speaker Out jack on the TV. Set to 0 to disable audio output. Otherwise, see the table below and set as required in accordance with audio equipment.

	Value	Status
Speaker Output	1	Fixed 0.01 Watts
	2	Fixed 0.03 Watts
	3	Fixed 0.05 Watts
	4	Fixed 0.10 Watts
	5	Fixed 0.20 Watts
	6	Fixed 0.50 Watts
	7	Fixed 1.00 Watt (default)
	8	Control with volume
Line Output	9	Fixed line level (typically 400 mVrms ± 100 mVrms @10KΩ) output

See also Reference section, “External Stereo Speaker Setup.”

098 - PRO:CENTRIC

Selects the Pro:Centric Application Mode. Set to 0 (default) to disable the Pro:Centric application. Set to 1 for Flash Mode. Set to 2 for GEM (Java Application) Mode.

In order to retrieve the Pro:Centric application, when enabled (for Flash or GEM Mode), the TV must be turned OFF/ON two times. Once you exit the Installer Menu, turn OFF the TV for at least one minute. When you turn the TV back ON, the TV will start the appropriate library based on the setting of this item. Wait until TV programming appears on the display, and then turn the TV back OFF, this time for a few minutes, to initiate the application download. When you turn the TV back ON, press the PORTAL key on the Installer Remote, and verify that the Pro:Centric application appears on the display.

Note: This item is not available in the Installer Menu when item 119 DATA CHANNEL is set to 0.

099 - BACK LIGHTING

Sets the TV screen brightness at power up. Default setting is 255.

- 1 (dimmiest picture)– 100 (brightest picture) Static Back Lighting
- 101 (dimmiest picture)– 200 (brightest picture) Dynamic Back Lighting: The TV automatically controls back lighting depending upon the picture level of the current program.
- 201 Automatic Static Back Lighting: Applicable for 32/42LY560M only. The TV automatically controls back lighting by using Intelligent Sensor to detect the level of ambient lighting.
- 202 Automatic Dynamic Back Lighting: Applicable for 32/42LY560M only. The TV automatically controls back lighting by using Intelligent Sensor to detect the level of ambient lighting and depending upon the picture level of the current program.

If set to 201 or 202 (32/42LY560M only), back lighting can be controlled via the Picture settings in the TV setup menus. However, each time the TV is turned ON, Picture Mode (set in Picture Menu) is defaulted to Intelligent Sensor. If Picture Mode is manually set to a static option (Vivid, Standard, etc.) during a viewing session, Intelligent Sensor is temporarily disabled.

If set to 255, back lighting is controlled via the Picture settings in the TV setup menus.

102 - ATSC BAND

Sets up TV to receive different types of incoming signals:

0 = Broadcast, 1 = CATV, 2 = HRC, 3 = IRC, 4 = Same as NTSC.

103 - ATSC TUNE MODE

Sets ATSC tuning mode: Default set to 1 for Physical Channel scan. Set to 0 for Virtual Channel scan.

104 - START MINOR CHANNEL

Sets Minor Start Channel number at power up. 0 = NTSC. If not 0, number selected is the digital channel's Minor Start Channel number.

Note: This item is not available in the Installer Menu when item 004 STRT CHANNEL is set to 0 or 255.

106 - ASP RATIO LOCK (Aspect Ratio Lock)

Set to 1 to retain previous aspect ratio with power off. Set to 0 to retain default aspect ratio with power off. See item 096 DEF. ASP. RATIO above.

116 - VIDEO MUTE EN (Video Mute Enable)

Applicable for analog channels only. If set to 1, video mutes (blank screen) when no signal is present.

Installer Menu (Cont.)

117 - FACT DEFAULT (Factory Default)

Set to 1 and press OK to restore the factory default settings of all Installer Menu items. Once complete, the value returns to 0.



Caution: If set to 1, this clears all Installer Menu custom settings and restores the factory default settings. It also clears the channel lineup, including any assigned channel icons and custom text labels.

Note: See also Reference section, “Restoring Factory Defaults on the TV(s),” for further information.

119 - DATA CHANNEL

Set to 0 to disable. Set from 1 to 135 to match the RF channel number that will be used by the Pro:Centric server as its data channel. If left at the default value (255), the TV's Data Channel Auto Search feature will be enabled (see additional information below).*

Data Channel Auto Search feature: When this item is set to 255 (default), once every 24 hours, the TV will initiate a search of 10 predefined channels (10, 20, 30, ... 100) and then, if necessary, perform a complete search of the RF channels (1 to 135) in an attempt to find the RF channel used by the Pro:Centric server as its data channel. If the Pro:Centric RF channel is found, the DATA CHANNEL value will be changed from 255 to match the server's RF channel number. The time at which the Auto Search occurs depends on the setting of item 121 UPDATE TIME HR. See item 121 description for further information.

Note: Pro:Centric updates are downloaded from the Pro:Centric server to the TV when the TV is turned OFF. While Pro:Centric updates are in progress, it is not possible to turn ON the TV.

Note: The Data Channel is automatically set to “253” if Media Type is set to “IP” either in the Express Script Installer Menu Wizard or in the IP Environment / Pro:Centric Menu on the TV (see “Express Script Installer Menu Wizard” on pages 12 to 17 or “Pro:Centric Setup” on pages 59 to 60, respectively) or if Installer Menu item #119 Data Channel is set to “IP Address” in the FTG File Manager, which is used to configure TV CPUs for FTG Mode operation. It is not possible to change the value to “253” directly in the Installer Menu.

121 - UPDATE TIME HR

Based on the settings of this item and item 122 UPDATE TIME MN, the Wake For Update feature wakes the TV once daily to check for and, if applicable, download updates from the Pro:Centric server.

Set the Wake For Update hour from 0 to 23. This item uses the 24-hour clock format. The value “128” (default) is displayed as “OFF.” Directly entering 128 resets the default value (OFF) for this item, though note that this setting does not mean the TV will not initiate update events—see additional information below.

If Wake For Update is OFF, the time at which a Data Channel Auto Search (item 119 set to 255) occurs is determined as follows: The TV will initiate the search at 2:00 PM (if the TV clock is set) or after 14 hours of elapsed time from when AC power was applied (if the TV clock is not set).

If the TV display is ON when the Auto Search is due to occur, the Auto Search will take place the next time the TV is turned OFF.

Note: This item is not available in the Installer Menu when item 119 DATA CHANNEL is set to 0.

Note: The TV clock must be set in order for a Wake For Update event to occur at the precise time of day in accordance with item 121 and item 122 settings.

122 - UPDATE TIME MN

Set the Wake For Update minute from 0 to 59. See also description for item 121 UPDATE TIME HR above.

Note: This item is not available in the Installer Menu unless item 121 UPDATE TIME HR is set from 0 to 23.

Note: The TV clock must be set in order for a Wake For Update event to occur at the precise time of day in accordance with item 121 and item 122 settings.

* PCS150R and later Pro:Centric servers do not support HRC or IRC cable channel frequencies.

This section describes how to create a customized Master TV Setup for cloning purposes when the TV is in Pass-through Mode.

Note: Cloning requirements and procedures are described in detail on pages 41 to 45. Refer to FTG Mode information on pages 46 to 52 for details on entering FTG Mode and configuring/editing the FTG Channel Map and FTG Installer Menu settings.

Before You Begin

- It is recommended that you disconnect all Aux inputs if you intend to run Auto Tuning (Channel Search). Under certain conditions, Auto Tuning is disabled if there is an Aux input active.
- If not disabled in the Installer Menu, Aux inputs will appear in the channel lineup between analog and digital channels after the TV setup is transferred to the commercial controller (PTC).
- All Learning and Teaching processes on these TV models are performed via USB memory device. See “Cloning Methods” below to determine the type of file—either the TLX file format or the legacy TLL file format—to use for cloning purposes. Several of the Master TV Setup procedure steps are dependent on the desired file type.

Cloning Methods

See also “Clonable TV Setup Menu Features” list below.

Using a USB Memory Device / TLX File

- The TLX file format clones Installer Menu settings, IP Environment Menu settings (with the exception of network settings), and all TV sources’ (analog, digital, AV1, HDMI, etc.) clonable setup menu settings.
- Not intended for cloning an auto-tuned/edited channel lineup, as the channel lineup is converted to an FTG Channel Map when saved (Learned) from a TV to a TLX file. If the TLX file with the FTG Channel Map is then used for Teaching purposes, the Target TV(s) will be configured for FTG Mode.

Using a USB Memory Device / TLL File

The TLL file format only clones the contents of the commercial controller (PTC) memory, which is limited to an auto-tuned/edited channel lineup, Installer Menu settings, and one TV source’s (analog, digital, or Aux) clonable setup menu settings.

Clonable TV Setup Menu Features

Channel Auto Tuning (Channel Lineup) Manual Tuning Channel Edit Channel Label	Audio Auto Volume Clear Voice Balance Sound Mode AV Sync. Adjust *	Time Clock Mode (Auto/Manual) * Time Zone Auto Off
Picture Picture Mode *		Option Language Caption Standby Light

* Advanced Control (Picture Mode), AV Sync. Adjust, and DST (Clock Mode) settings are cloned via TLX file only.

Notes:

- Some menu options vary between analog and digital channels and Aux inputs.
- The end user only has access to features that are available on the pillow speaker or the user remote control if provided by the institution.

Custom Master TV Setup (Cont.)

Custom Master TV Setup Procedure

1. Turn ON the TV.

If the Express Script Installer Menu Wizard appears on the screen when you turn ON the TV, exit the wizard.

2. Set Installer Menu items.

This step provides specific instruction only on the Installer Menu items that should be set on a Master TV. Refer to pages 21 to 30 for detailed information on all Installer Menu items.

- a) Use the Installer Remote to access the PTC Installer Menu (see “Accessing the Installer Menu” on page 21 for further information).

The next step depends on whether the Express Script Installer Menu Wizard appeared when you turned ON the TV:

- If the wizard did appear, the TV is in a factory default state, and you can proceed to set Installer Menu items. Go to step (c).
- If the wizard did not appear, go to step (b).

- b) Set Installer Menu item **117 FACT DEFAULT** to **1** and press **OK** on the Installer Remote.

This clears all Installer Menu custom settings, channel lineup, etc. and restores the factory default settings. The value will change back to 0 after the PTC has been restored to factory default condition. This step ensures that the TV Channel Memory will be the active channel lineup.

- c) Set Installer Menu item **003 BAND/AFC**, as appropriate.

- Broadcast: Set to 0. • HRC: Set to 2.
- CATV: Set to 1 (default). • IRC: Set to 3.

- d) Set Installer Menu item **027 HOSPITAL MODE**, as appropriate, to select the speaker configuration.

- e) Set any other Installer Menu items that affect your TV programming network to the required configuration. For example, enable/disable Aux inputs, set a Start Channel, etc.

If you intend to use a TLX file for cloning purposes, you may also configure Pro:Centric settings in the IP Environment Menu (accessible from the Installer Menu). See “IP Environment Setup” on pages 57 to 60 for further information. However, note that you cannot return directly to the Installer Menu from the IP Environment Menu; thus, you may wish to set all Installer Menu items as needed before you access the IP Environment Menu. Otherwise, you will need to reaccess the Installer Menu to set additional items.

- f) After you have adjusted all Installer Menu item settings as required, press **OK** once on the Installer Remote to save your changes; then, press **OK** again to exit the menu.

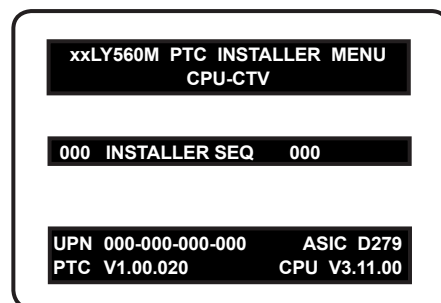

Typical Installer Menu

Note: The Installer Menu header will vary depending on the TV you are setting up.



Adjust the values for these Installer Menu items.

Note: If an Aux input will not be used, it is advisable to disable it. After the TV setup is transferred to the PTC (see step 5), the only way to remove Aux inputs from the channel lineup, is to go to the Channel Preview/Banks Setup Menu and select Normal-Deleted.

(Continued on next page)

(Continued from previous page)

3. Set up TV features.

On-screen setup menus control the features of the TV. Press **MENU** on the Installer Remote to access the TV setup menus, and then set Channel, Picture, Audio, etc. options to the desired configurations. See “Clonable TV Setup Menu Features” list page 31 and also notes below.

Note: If you intend to use a TLX file for cloning purposes, and you wish to use the TV Zoning feature, make sure to assign the appropriate TV Zone # at this time as described in Reference section, “Using the TV Zoning Feature.”

Note: If you intend to clone the PTC, remember that only one TV source’s clonable setup menu settings will be cloned. Thus, the TV setup menu settings should be applicable to the analog or digital channel or Aux input to which the Target TV will be set during Teaching.

Note: If desired and if appropriate, depending on the cloning method to be used (see “Cloning Methods” on page 31), you can run Auto Tuning (see step 4) prior to completing this step.

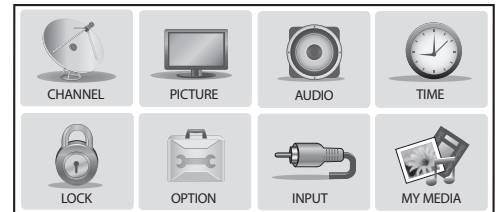

Use the TV setup menus to set the TV features to the desired configuration for the end user.

Audio Menu Note: Audio Menu options are inaccessible (grayed out) if TV Speaker is not selected (i.e., Pillow Only is selected).



Note: The next three steps (4 to 6) are applicable for PTC cloning only (i.e., cloning using a TLL file). If you intend to use a TLX file for cloning purposes, proceed directly to step 7 to verify the TV setup.

4. (PTC cloning only / Optional) Run Auto Tuning.

Note: If you run Auto Tuning with the intention to clone the resulting channel lineup and the Target TV(s) is/are to remain in Pass-through Mode, you **MUST** use a TLL file for this cloning purpose.

- Use the Installer Remote to access the Channel Menu. Then, select **Auto Tuning** and follow the on-screen instructions to search for all available analog and digital channels.
- Use the **Channel Edit** option in the Channel Menu to edit the channel lineup, as necessary. Add/delete channels per your system requirements.
- Use the **Channel Label** option in the Channel Menu to select the appropriate trademark/icon for each channel’s Channel-Time on-screen display. Icons are available for familiar channels, such as ABC, CBS, NBC, etc. Identifiable labels (icons) should enable the end user to readily know what common networks are available.

Note: If Installer Menu item 103 ATSC TUNE MODE is set for Physical Channel tuning (default and recommended setting), channels with minor channel numbers higher than 255 will not transfer correctly in step 5. If item 103 is set for Virtual Channel tuning and either the major or minor channel numbers are higher than 255, the channel(s) will not transfer correctly in step 5.

Note: You can add the channel icons in this step or as described in step 6. Also in step 6, you can add custom text labels for channels without icons.

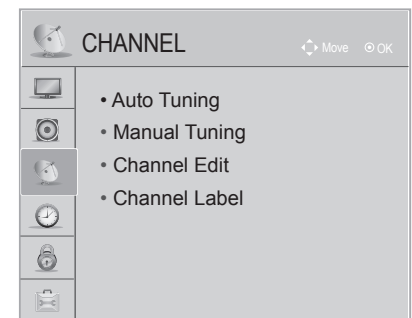

Use Channel Menu options to run Auto Tuning, edit channels, and select channel icons.

(Continued on next page)

Custom Master TV Setup (Cont.)

(Continued from previous page)

5. (PTC cloning only) Transfer the auto-tuned/edited channel lineup (if applicable) and TV setup menu settings to the PTC: 2-5-5 + MENU Mode



Note: This step is essential for successful cloning using a TLL file. Without this step, the PTC will not contain any channels or TV setup menu settings.



Note: The maximum number of channels (analog, digital, and Aux inputs) that can be transferred to the PTC is 141. An attempt to transfer more than 141 channels of any combination will result in a PTC Channel Map of exactly 141 channels; any extra channels will not be available in the PTC Channel Map. For example, if you enabled three Aux inputs in the Installer Menu and Auto Tuning found 141 channels, you must edit the TV channel lineup to decrease the number of analog/digital channels to (at most) 138 in order to accommodate the Aux inputs in the PTC Channel Map. Note that Aux inputs will appear between the highest analog and lowest digital channel number in the PTC Channel Map.



Note: If you did not run Auto Tuning, no analog or digital channels will be transferred to the PTC Channel Map upon completion of this step. In this case, the only channels in the PTC Channel Map will be any enabled Aux inputs.

- a) After the TV channel lineup has been edited and channel label icons added, tune to the channel (source) for which you wish to transfer TV setup menu settings.
- b) Access the Installer Menu, and press **2-5-5 + MENU** on the Installer Remote to initiate the transfer of the Master TV Setup to the PTC. The TV exits the Installer Menu and then tunes through the channels in the channel lineup during the transfer. When the transfer is complete, the TV tunes back to the channel that was tuned before the transfer began.

Note: Scan Mode is not functional until the TV setup is transferred.

6. (PTC cloning only / Optional) Add Custom Channel and Aux Input Labels: 2-5-4 + MENU Mode

2-5-4 + MENU Mode enables you to add/edit channel icons and custom text labels in the PTC Channel Map once the Master TV Setup has been transferred as described in the previous step.

Access the Installer Menu, and press **2-5-4 + MENU** on the Installer Remote. Add/edit custom text labels and/or change icons for the Channel-Time on-screen displays (see 2-5-4 + MENU procedural information on page 36). Note that broadcast digital channels often already have a broadcaster generated label. When you are finished, press **MENU** to exit 2-5-4 + MENU Mode.

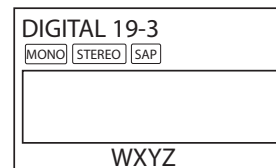

Custom Text Label "WXYZ" created in 2-5-4 + MENU Mode.

(Continued on next page)

(Continued from previous page)

7. Verify the TV setup.

Make sure the TV features are set per your requirements. Also, if cloning an auto-tuned/edited channel lineup, verify that the channel lineup, channel icons, and custom text labels (as applicable) are correct.

8. Set up channel banks.

Set up channel banks, as desired (see pages 37 to 40).

Note: When you lock the channel lineup (see next step), the Channel Preview/Banks Setup Menu is no longer accessible via the Installer Remote. If you wish to set up channel banks at a later time, you will need to set Installer Menu item 028 CH. OVERRIDE to 1 to enable access to the Channel Preview/Banks Setup Menu.

9. (Recommended) Lock the channel lineup.

Access the Installer Menu, set item **028 CH. OVERRIDE** to **0**, and press **OK** to lock the channel lineup and restrict access to the TV setup menus. This step prevents end users from accessing channel settings (i.e., the Channel Menu will be inaccessible/grayed out). Press **OK** again to save your changes and exit the Installer Menu.

The Master TV Setup is now ready to be saved to a USB memory device (TLX or TLL file). See "Cloning Procedures" on pages 41 to 45.

028	CH. OVERRIDE	000
------------	---------------------	------------

After verifying the TV Setup, it is recommended that you set Installer Menu item 028 CH. OVERRIDE to 0.

Channel Icons / Custom Text Labels (2-5-4 + MENU Mode)

Changing Channel Icons and/or Adding or Editing Custom Text Labels in the Channel-Time Display

If there is no pre-assigned icon for a channel, you can add a custom text label of up to seven (7) characters to help identify the channel or network. Also, if desired, a custom text label can be added to the Channel-Time display in addition to a pre-assigned icon. You may also add text labels for the Aux input sources to clearly identify the devices that are connected to the Aux inputs.

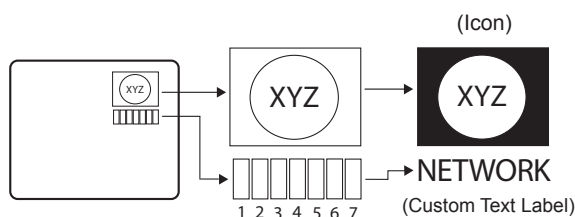

Changing icons and/or adding or editing custom text labels can only be done if there are channels that have been transferred to the TV's PTC either during the Express Script/Custom Master TV Setup (see pages 12 to 17 or pages 31 to 35, respectively) or by cloning (TLL file only). **Note:** A blank letter space is available between "Z" and "!".

To perform channel editing/labeling:

1. Use the Installer Remote to access the TV Installer Menu (see "Accessing the Installer Menu" on page 21 for further information).
2. Press **2-5-4 + MENU** on the Installer Remote to access the Channel Label Editing Menu.
3. Change channel icons and/or add or edit custom text labels as described in the procedures below. (You can do this more than once.)
4. To exit the menu when you are done, press **MENU**.

Changing a Channel's Icon on the Master TV

1. Use Channel Up/Down to select the desired channel.
2. Use the Left/Right arrow keys to select the thin letter "I" on the Channel-Time display.
3. Use the Up/Down arrow keys to select the icon with which you want to identify the channel. (If you know the icon number, enter the number, and press **OK**.)
4. Proceed to add/edit custom text labels, or go to the next channel.

Adding/Editing Channel Labels on the Master TV

1. Use Channel Up/Down to select the desired channel.
2. Press the Left or Right arrow repeatedly until the numbers 1 to 7 appear on the display. The number shows the position of the character that can be changed. Number 1 is the first character, number 2 the second character, etc.
3. Use the Up/Down arrow keys to select the desired character.
4. Proceed to the next number position, or go to the next channel.

Adding/Editing Source Labels on the Master TV

1. Press **CH. BANK** to select the desired Aux input source: AV1, RGB, HDMI1, or HDMI2.
2. Press the Left or Right arrow repeatedly until the numbers 0 to 9 appear on the display. The number shows the position of the character that can be changed.
3. Use the Up/Down arrow keys to select the desired character.
4. Press **CH. BANK** for the next Aux input, or use Channel Up/Down to return to channels.

Installer Remote Control Key Functions for Master TV Channel Label Editing Menu

- **Channel Up/Down:** Tunes to the next channel in scan.
- **Left/Right Arrows:** Select the item to change. If "I" is shown, the icon can be changed. If a number is shown, it indicates the position of the character that can be changed.
- **Up/Down Arrows:** Select the icon or the character to be displayed. Tip: Arrows can be held down for fast scrolling.
- **0 – 9:** Use to enter the index number of the icon, if known.
- **OK:** Changes the icon after the icon number has been entered.
- **CH. BANK:** Use to select Aux inputs.
- **MENU:** Exits the editing process.

Channel Banks Overview

Channel Banks enable institution administrators to create tiered channel programming on patient in-room TVs. Each channel bank may offer a custom channel lineup for a pre-determined fee. LY560M TVs are configured with four channel banks, i.e., Channel Banks 1, 2, 3, and 4. The top tier generally contains the most programming (premium, etc.), 2nd tier = lesser programming, 3rd tier = basic programming, etc. It is also possible to create an Inactive TV display with Channel Bank 4, so that an “Inactive TV Call Attendant” message appears when the TV is turned ON. In this case, an administrator can then select another channel bank on the patient’s in-room TV depending on the programming tier requested by the patient.

All channels found during Auto Tuning automatically will be “ADDED” to all four channel banks, and the default is for all channels to be active (NORMAL) in Channel Banks 1, 2, 3, and 4.

 **Note: Channel banks are not supported on TVs that are configured for FTG Mode operation.**

Before You Begin

- Run the Express Script Installer Menu Wizard or complete the Custom Master TV Setup procedure (see pages 12 to 17 or pages 31 to 35, respectively).

Note: Channel banks can be defined as part of the Express Script Installer Menu Wizard, if desired. However, if you are setting up channel banks after completing the Express Script or if you are creating a customized Master TV Setup, use the Channel Preview/Banks Setup Menu as described below.

- Installer Menu item 028 CH. OVERRIDE must be set to 1 to allow access for channel banks setup.

Accessing the Channel Preview/Banks Setup Menu

1. To select a channel bank, press **CH. BANK** on the Installer Remote. The first time you press the CH. BANK key, the TV display will show the currently active channel bank. Press **CH. BANK** repeatedly until the desired channel bank is selected.
2. After the desired channel bank is selected, press **CH. PREVIEW** on the Installer Remote to display the Channel Preview/Banks Setup Menu (see below).

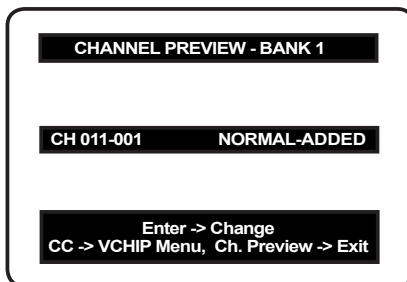

Typical Channel
Preview/Banks Setup
Menu

 **Note: In the Installer Menu, all available Aux inputs are enabled by default. The Aux inputs will appear between the highest analog and lowest digital channel number in the PTC Channel Map when Channel Up/Down is used on the Installer Remote. If an Aux input will not be used, it is advisable to disable it. If using the Express Script, customize the Aux inputs as appropriate in the Aux Input screen (step 2). If performing the Custom Master TV Setup procedure, ensure Installer Menu items 035, 039, 087, and 091 are set as required before performing the 2-5-5 + MENU operation (step 5). After the TV setup is transferred to the PTC, the only way to remove Aux inputs from the channel lineup, is to go to the Channel Preview/Banks Setup Menu and select Normal-Deleted.**

Channel Banks Setup (Cont.)

Channel Status Options for Channel Banks

In the Channel Preview/Banks Setup Menu, use the Channel Up/Down arrows on the Installer Remote to navigate to a channel and the Left/Right arrows to select the channel status.

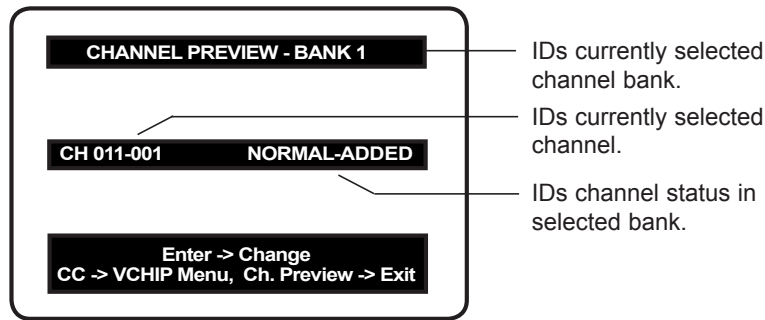

Typical Channel Preview/Banks Setup Menu

Channel Status Options

- **NORMAL-ADDED:** Channel will appear in channel lineup of currently selected channel bank.
- **NORMAL-DELETED:** Channel will not appear in channel lineup of currently selected channel bank.
- **BLANK-ADDED:** Channel will appear in all channel banks, with standard audible audio; however, video will be black (no picture).
- **BLANK-DELETED:** Channel will not appear in channel lineup of currently selected channel bank, and in all other channel banks, channel will be assigned BLANK-ADDED status.

Adding / Deleting / Blanking Channels

It is best to complete ADD / DELETE customization before assigning BLANK status. All channels found during Auto Tuning are automatically assigned NORMAL-ADDED status in Channel Banks 1, 2, 3, and 4. NORMAL-ADDED and NORMAL-DELETED status can be assigned independently for Channel Banks 1, 2, 3, and 4. However, a channel blanked, is blanked in all channel banks.

Note: Auto Tuning removes any channels previously customized with ADD / DELETE / BLANK.

Note: On individual TVs, if a channel was not found during Auto Tuning (and was not added during Express Script/Custom Master TV Setup procedures), it can be added using the Manual Tuning option in the Channel Menu.

Selecting Deleted Channels

To tune to a NORMAL-DELETED channel:

1. Select a channel bank where the channel's status is NORMAL-ADDED.
2. Navigate to or direct enter the channel number.
3. Select the channel bank where the channel's status is "NORMAL-DELETED," and reconfigure the channel status in the Channel Preview/Banks Setup Menu.

Inactive TV Setup

There are two options for creating an inactive TV display on Channel Bank 4. Either:

- Select **NORMAL-DELETED** for each channel in Channel Bank 4, or
- Press **CH. BANK** on the Installer Remote until Channel Bank 4 is selected, and then press **CH. PREVIEW** to display the Channel Preview/Banks Setup Menu. Then, press the **SAP** key on the Installer Remote to automatically delete all channels in Channel Bank 4.

When the TV is turned ON by the patient, an “Inactive TV Call Attendant” message will appear on the screen, and after a few moments the TV will turn itself OFF. This will prompt the patient to arrange for an available programming package on Channel Bank 1, 2, or 3. Using the Installer Remote, the administrator can select Channel Bank 1, 2, or 3 depending on the entertainment programming tier selected by the patient. When the patient leaves the hospital, the administrator can then select Channel Bank 4 to reinstate the “Inactive TV” message.

Channel Banks Worksheets

Use Channel Banks Worksheets (see following page) to create channel status charts as part of the setup process. On the channel status charts, show the status for each channel in all channel banks. This then becomes the patient entertainment programming offerings plan.

The following examples show “before-and-after-customization” portions of channel status charts with analog channels, Aux inputs, and digital channels.

Example: Channel Banks After Auto Tuning

BANK	Analog			Aux			Digital													
	2	5	7	AVI	RGB	HDM1	4-1	6-1	13-1	20-5	20-6	30-1	32-1	40-1	40-11	44-1	44-11	45-1	45-11	
1	A	A	A	A	A	A	A	A	A	A	A	A	A	A	A	A	A	A	A	A
2	A	A	A	A	A	A	A	A	A	A	A	A	A	A	A	A	A	A	A	A
3	A	A	A	A	A	A	A	A	A	A	A	A	A	A	A	A	A	A	A	A
4	A	A	A	A	A	A	A	A	A	A	A	A	A	A	A	A	A	A	A	A

A = Active (channel found during Auto Tuning and automatically assigned NORMAL-ADDED status)

Example: Channel Banks After Auto Tuning and Customization with Add/Del/Blk Options

BANK	Analog			Aux			Digital													
	2	5	7	AVI	RGB	HDM1	4-1	6-1	13-1	20-5	20-6	30-1	32-1	40-1	40-11	44-1	44-11	45-1	45-11	
1	BA	A	A	A	A	A	A	A	A	A	A	A	A	A	A	A	A	A	A	A
2	BA	A	A	A	A	A	A	D	D	A	A	A	A	A	A	D	D	D	D	D
3	BD	D	D	A	A	D	A	A	D	D	A	A	A	D	D	D	D	D	D	D
4	D	D	D	D	D	D	D	D	D	D	D	D	D	D	D	D	D	D	D	D

A = Active channel (channel found during Auto Tuning and retains NORMAL-ADDED status)

D = Deleted channel (channel assigned NORMAL-DELETED status in the Channel Preview/Banks Setup Menu)

BA = Channel assigned BLANK-ADDED status in the Channel Preview/Banks Setup Menu

BD = Channel assigned BLANK-DELETED status in the Channel Preview/Banks Setup Menu

Channel Banks Worksheet

Use this worksheet to plan your program packages. (Photocopy additional worksheets as needed.)

B A N K	Channel Number																			
1																				
2																				
3																				
4																				

B A N K	Channel Number																			
1																				
2																				
3																				
4																				

B A N K	Channel Number																			
1																				
2																				
3																				
4																				

B A N K	Channel Number																			
1																				
2																				
3																				
4																				

B A N K	Channel Number																			
1																				
2																				
3																				
4																				

Date _____ Installer _____ Page ___ of ___
 Location _____

Cloning Overview

Cloning refers to the process of capturing a Master TV Setup and transferring it to a Target TV that is to remain in Pass-through Mode. There are two different procedures for cloning a Master TV Setup, each with its own advantages and limitations (see also “Cloning Methods” on page 31):

- Using a USB memory device / TLX file
- Using a USB memory device / TLL file

Each cloning method is described in further detail on the pages that follow.

Learning / Teaching a Master TV Setup using a TLX File

This section describes how to Learn and/or Teach a Master TV Setup using a TLX file.

Before You Begin

- Learning and Teaching is only possible between identical model TVs.
- Complete the Custom Master TV Setup procedure (see pages 31 to 35).
- Both the Master and Target TVs must be in Pass-through Mode (i.e., the TV setup menus should be displayed when you press **MENU** on the Installer Remote).
- Ensure the USB device has been formatted with FAT format.
- If you would like the Target TV(s) to remain in Pass-through Mode after Teaching, ensure the Master TV does not have an auto-tuned/edited channel lineup; otherwise, Teaching will result in the Target TV(s) being configured for FTG Mode.
- If a TV Zone # has been set in the Master TV (for location-specific configuration) before the Learning process is initiated, the Zone designation will be used during the subsequent Teaching process(es). This means that in order for the “Learned” clone data with the TV Zone assignment to be applied, any Target TVs will need to be assigned the same Zone designation BEFORE Teaching is performed. See Reference section, “Using the TV Zoning Feature,” for further information. See also bullet below.
- If you intend to use the TV Zoning feature, make sure to assign a TV Zone # as described in Reference section, “Using the TV Zoning Feature,” BEFORE continuing with the Learning procedure below. See also bullet above.
- It is not possible to clone a Master TV’s clock. Either set a Target TV’s clock manually, or use the Auto Clock setting in the TV setup menus.



Caution: Do not unplug the TV power cord or remove/disconnect the USB memory device while Learning or Teaching, as doing so may cause the TV to malfunction or harm the USB device, respectively.

Cloning Procedures (Cont.)

Learn Setup from Master TV

1. Ensure the Master TV is set up completely and in Pass-through Mode.
2. Insert the USB memory device into the USB port on the Master TV.
3. Press **MENU** on the Installer Remote to display the TV setup menus. Use the arrow navigation keys to select/highlight the **Option** menu icon, and then press the number “7” key a total of seven times to display the TV Manager / USB Download Menu.
4. To gain access to the “Learn From TV” options in the TV Manager / USB Download Menu, key in the following number sequence on the Installer Remote: **9-8-7-6**.
5. Use the Up/Down arrow keys to select **Learn From TV (TLX)**, and then press **OK**.
6. In the Learn From TV (TLX) window, to differentiate this TLX file from others, you can use the Up/Down arrow keys to change the last five digits of the filename. Press **OK** when you are ready to initiate Learning. Learning status will be shown on a progress bar in a new window. Do NOT remove the USB device until Learning is complete. When the Learning process is complete, the TV Manager / USB Download Menu will reappear on the screen.
7. When Learning is done, press **CC** or **↵** on the Installer Remote to exit the TV Manager / USB Download Menu, and remove the USB memory device from the Master TV.

Teach Master TV Setup to Target TV

Note: You may also use the Ez Download utility to complete the Teaching process, if desired. See “Ez Download Utility” on pages 18 to 20 for further information.

1. Turn **ON** the Target TV.
The next step depends on whether the Express Script Installer Menu Wizard appears on the screen:
 - If the wizard is displayed, the TV is in the required factory default state. Exit the wizard, and then, go to step 3.
 - Otherwise, ensure the Target TV is in Pass-through Mode, and then continue with step 2.
2. Use the Installer Remote to access the Target TV Installer Menu (see “Accessing the Installer Menu” on page 21 for further information). Set Installer Menu item **117 FACT DEFAULT** to **1**, and press **OK**. When the value changes back to 0, press **OK** again to exit the Installer Menu. This step restores factory default settings on the TV.

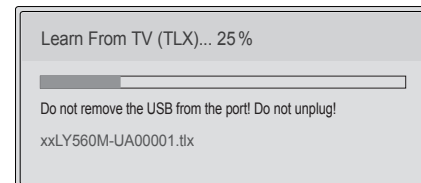
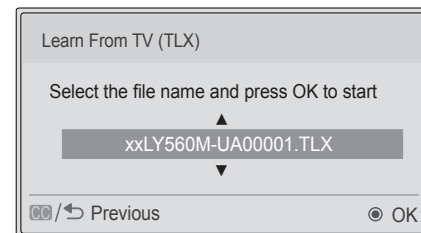
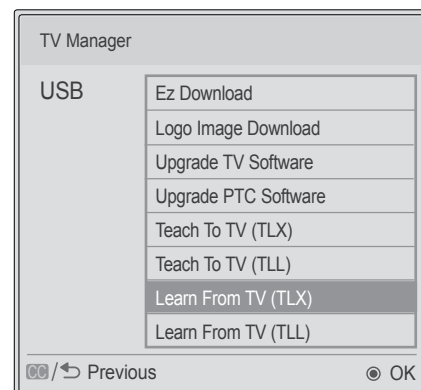

(Continued on next page)

(Continued from previous page)

3. If the Master TV Setup contains a TV Zone # assignment, make sure to assign the same Zone designation in the Target TV at this time. See Reference section, "Using the TV Zoning Feature," for further information.



Note: In order for the proper location-specific TV Zone profile data to be applied, the Zone designation must be assigned in the Target TV(s) BEFORE Teaching is performed.

4. Insert the USB memory device with the TLX file into the Target TV's USB port.
5. Press **MENU** on the Installer Remote to display the TV setup menus. Use the arrow navigation keys to select/highlight the **Option** menu icon, and then press the number "7" key a total of seven times to display the TV Manager / USB Download Menu.
6. With the TV Manager / USB Download Menu on display, use the Up/Down arrow keys to select **Teach To TV (TLX)**, and then press **OK**.
7. In the Teach To TV (TLX) window, use the Up/Down arrow keys to select the Master TV Setup you want to install.

Note: Filenames for TLX files Learned from a TV are comprised of the TV model and a five-digit number, for example, xxLY560M-UA00001.TLX.

8. Press **OK** when you are ready to initiate the Teaching process.

Teaching status will be shown on a progress bar in a new window. Do NOT remove the USB device until Teaching is complete. When the Teaching process is complete, the TV will briefly display a "Teaching Completed" window and then exit the TV Manager / USB Download Menu.

9. Remove the USB memory device, and verify that the Master TV Setup is now resident on the Target TV.

After the Teaching process is complete, the TV tunes according to the setting of Installer Menu item 004 STRT CHANNEL (Start Channel). If a Start Channel is specified, the TV will tune to that channel; otherwise, the TV will return to the last channel tuned.

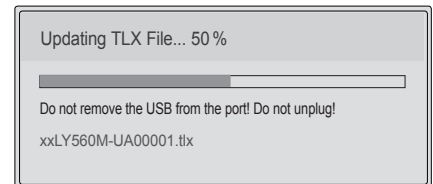
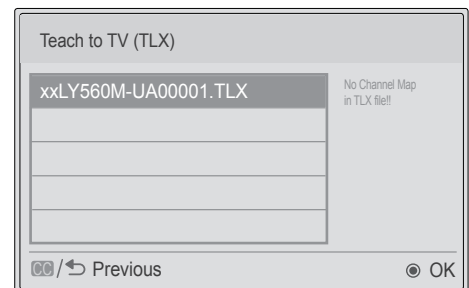
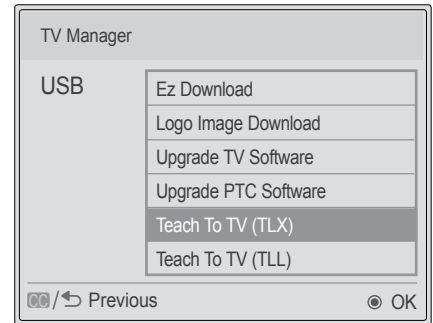

Cloning Procedures (Cont.)

Learning / Teaching a Master TV Setup using a TLL File

This section describes how to Learn and/or Teach a Master TV Setup using a TLL file.

Before You Begin

- Learning and Teaching is only possible between identical model TVs.
- Complete the Custom Master TV Setup procedure or run the Express Script Installer Menu Wizard (see pages 31 to 35 or pages 12 to 17, respectively).
- Both the Master and Target TVs must be in Pass-through Mode (i.e., the TV setup menus should be displayed when you press **MENU** on the Installer Remote).
- Ensure the USB device has been formatted with FAT format.
- You may edit the filename as part of the Learning procedure; however, a file with edited contents will not be recognized.
- It is not possible to clone a Master TV's clock. Either set a Target TV's clock manually, or use the Auto Clock setting in the TV setup menus.

 **Caution: Do not unplug the TV power cord or remove/disconnect the USB memory device while Learning or Teaching, as doing so may cause the TV to malfunction or harm the USB device, respectively.**

Learn Setup from Master TV

1. Ensure the Master TV is set up completely and in Pass-through Mode.
2. Insert the USB memory device into the USB IN port on the Master TV.
3. Press **MENU** on the Installer Remote to display the TV setup menus, use the arrow navigation keys to select/highlight the **Option** menu icon, and then press the number “7” key a total of seven times to display the TV Manager / USB Download Menu.
4. To gain access to the “Learn From TV” options in the TV Manager / USB Download Menu, key in the following number sequence on the Installer Remote: **9-8-7-6**.
5. Use the Up/Down arrow keys to select **Learn From TV (TLL)**, and then press **OK**.
6. In the Learn From TV (TLL) window, to differentiate this TLL file from others, you can use the Up/Down arrow keys to change the last five digits of the filename. Press **OK** when you are ready to initiate Learning.
Learning status will be shown on a progress bar in a new window. Do NOT remove the USB device until Learning is complete. When the Learning process is complete, the TV Manager / USB Download Menu will reappear on the screen.
7. When Learning is done, press **CC** or **↵** on the Installer Remote to exit the TV Manager / USB Download Menu, and remove the USB memory device from the Master TV.

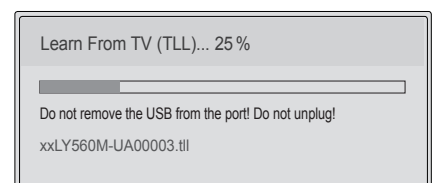
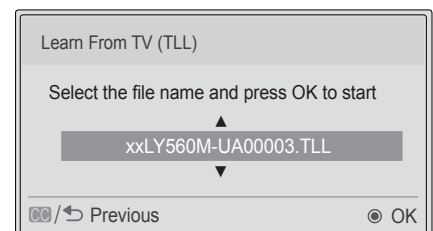
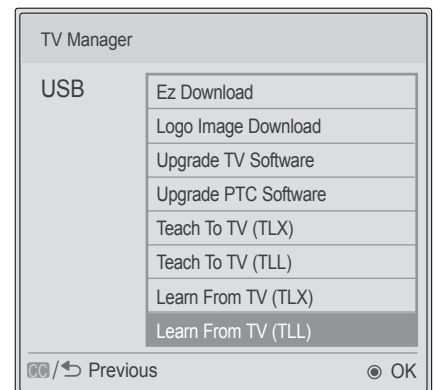

Teach Master TV Setup to Target TV

Note: You may also use the Ez Download utility to complete the Teaching process, if desired. See “Ez Download Utility” on pages 18 to 20 for further information.

1. Turn ON the Target TV.

The next step depends on whether the Express Script Installer Menu Wizard appears on the screen:

- If the wizard is displayed, the TV is in the required factory default state. Exit the wizard, and then, go to step 3.
 - Otherwise, ensure the Target TV is in Pass-through Mode, and then continue with step 2.
2. Use the Installer Remote to access the Target TV Installer Menu (see “Accessing the Installer Menu” on page 21 for further information). Set Installer Menu item **117 FACT DEFAULT** to **1**, and press **OK**. When the value changes back to 0, press **OK** again to exit the Installer Menu. This step restores factory default settings on the TV.
 3. Tune/set the TV to an analog or digital channel or Aux input (ideally the same source tuned for 2-5-5 + MENU Mode during the Custom Master TV Setup procedure, if applicable).
 4. Insert the USB memory device with the TLL file into the Target TV’s USB port.
 5. Press **MENU** on the Installer Remote to display the TV setup menus, use the arrow navigation keys to select/highlight the **Option** menu icon, and then press the number “7” key a total of seven times to display the TV Manager / USB Download Menu.
 6. With the TV Manager / USB Download Menu on display, use the Up/Down arrow keys to select **Teach To TV (TLL)**, and then press **OK**.
 7. In the Teach To TV (TLL) window, use the Up/Down arrow keys to select the Master TV Setup you want to install.

Note: Filenames for TLL files Learned from a TV are comprised of the TV model and a five-digit number, for example, xxLY560M-UA00003.TLL.
 8. Press **OK** when you are ready to initiate the Teaching process.

Teaching status will be shown on a progress bar in a new window. Do NOT remove the USB device until Teaching is complete. When the Teaching process is complete, the TV will briefly display a “Teaching Completed” window and then exit the TV Manager / USB Download Menu.
 9. Remove the USB device, and verify that the Master TV Setup is now resident on the Target TV.

After the Teaching process is complete, the TV tunes according to the setting of Installer Menu item 004 STRT CHANNEL (Start Channel). If a Start Channel is specified, the TV will tune to that channel; otherwise, the TV will return to the last channel tuned.

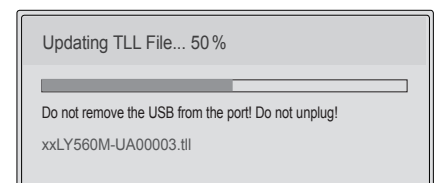
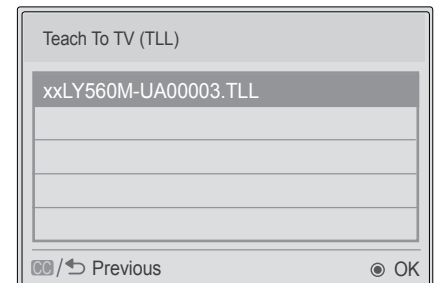
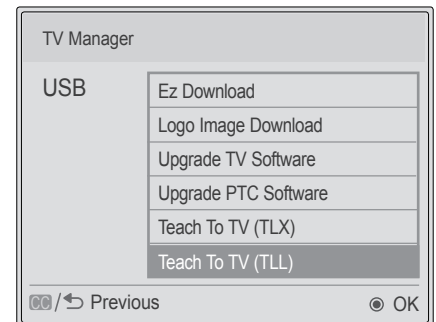

FTG Mode of Operation

This section describes how to create an FTG Configuration (.tlx) file using the FTG File Manager. It also describes how to locally configure a TV for FTG Mode operation. See also the FTG Mode overview on pages 7 to 8 for further information on FTG Mode.

Creating an FTG Configuration File

The procedure below describes how to use the FTG File Manager utilities to create an FTG Configuration (.tlx) file that can be saved to a USB memory device. In order to enable decryption of Pro:Idiom encrypted channels, it is recommended that you create or view/edit an FTG Configuration file using the FTG File Manager.

FTG File Manager software is available online at: www.LGolutions.com/ftgsoftware.

Note: There is also an option to save (Learn) FTG Configuration from a TV, which may be desirable or required if you want to save customized TV setup menu settings to the FTG Configuration file and/or if you do not know the RF channels at the site. See “Learning FTG Configuration from a TV” on pages 50 to 51 for further information.

This procedure below provides an overview of the steps required to create an FTG Configuration (.tlx) file. Refer to the **Free-To-Guest (FTG) File Manager User Guide** for further information. See also FTG File Manager sample screens on pages 53 to 56.

1. Install (if necessary) and launch the FTG File Manager (v1.1.8 or higher) on the PC that will be used to create the FTG Configuration (.tlx) file.
 2. You have a number of options:
 - To view and/or base a new FTG Configuration file on an existing FTG Configuration (.tlx) file, click the **Open** button in the TLX File command section of the FTG File Manager main screen, and select/double-click on the desired “.tlx” file.

A list of the file’s contents will be displayed in the TLX File Contents window. Either double-click on an individual item to copy it or click the **Copy All** button directly above the TLX File Contents window to automatically copy all the contents of the opened file to the FTG Configuration List and, if applicable, TV Setup Menu List. Note, though, that while TV setup menu settings can be included in the new FTG Configuration file, the TV setup menu settings are not available for editing.

Edit the configuration of the items in the FTG Configuration List as well as the FTG Configuration List itself and/or the TV Setup Menu List, as necessary, to create a new file. Then, proceed to step 3 when you are ready to continue.
 - To open an existing FTG Configuration (.rml) file created in the FTG Device Configuration Application to use its FTG Channel Map and/or FTG Installer Menu settings, click **File** and then **Open** from the FTG File Manager menu bar, and select/double-click on the desired “.rml” file.

Edit channels and/or settings as necessary. Then, proceed to step 3 when you are ready to continue.
 - Create a new FTG Channel Map using the FTG Channel Map Editor in the FTG Channel Map Configuration Utility. Up to 600 channels can be defined in the FTG Channel Map.

When you are ready to continue, click **Configure** and then **FTG File Manager** from the FTG File Manager menu bar to return to the FTG File Manager main screen, and then proceed to step 3.
- Note:** To remove an individual item from the FTG Configuration List or the TV Setup Menu List, click on/highlight the item to be removed, and then click the **Remove Item** button directly above the applicable “List” window. To clear both the current FTG Configuration List and TV Setup Menu List contents, click the **Clear** button in the List command section of the FTG File Manager main screen.

(Continued on next page)

(Continued from previous page)

Note: To clear the current TLX File Contents, click the **New** button in the TLX File command section of the FTG File Manager main screen (above the TLX File Contents window).

3. To add an FTG Channel Map to the FTG Configuration List, click **>>** under FTG Channel Map. This will copy the current mapped channels to the FTG Configuration List.

Note: If you make any change(s) in the FTG Channel Map Configuration Utility to the current data to be included in the FTG Configuration List, you will need to recopy the FTG Channel Map to the FTG Configuration List.

4. (Optional) Load default FTG Installer Menu settings for the TV:

- Click the down arrow at the right of the Chassis field in the Installer Menu Templates section of the FTG File Manager main screen, and select the appropriate chassis (22/28LY560M or 32/42560M) from the drop-down list of available models.
- Click the **Load** button.
- Use the FTG Installer Menu Configuration Utility to modify settings, if necessary. Then, return to the FTG File Manager main screen.

5. If you wish to assign a Zone designation for the current FTG Installer Menu settings, click on the down arrow at the right of the Zone field (below the FTG Installer Menu Settings field), and select the appropriate Zone (1–8).

Note: See Reference section, “Using the TV Zoning Feature,” for further information on the TV Zoning feature and setting the TV Zone # in the TV(s).

6. To add FTG Installer Menu settings to the FTG Configuration List, click **>>** under FTG Installer Menu Settings. This will copy the selected model’s settings to the FTG Configuration List.

Note: If you make any change(s) in the FTG Installer Menu Configuration Utility to the current data to be included in the FTG Configuration List, you will need to recopy the FTG Installer Menu settings to the FTG Configuration List.

Note: At the top of both the FTG Configuration List and TV Setup Menu List windows, an Edit Zone field enables you to change the Zone assignment for each LY560M Installer Menu and/or TV Setup Menu profile, if desired. Select/highlight the desired profile, and then click on the down arrow at the right of the applicable Edit Zone field to select the appropriate Zone.

7. Click the **Save** button in the List command section of the FTG File Manager main screen to save the FTG Configuration List and, if present, TV Setup Menu List contents to an FTG Configuration (.tlx) file on the PC’s hard drive for later use.

In the Save As pop-up window, name the file, and click **Save**. The default folder path is C:\Program Files\Zenith\FTG\TLX. Note that the FTG Configuration file will have a “.tlx” extension.

Note: To remove an individual item from the FTG Configuration List or the TV Setup Menu List before saving the new file, click on/highlight the item to be removed, and then click the **Remove Item** button directly above the applicable window. To clear both the current FTG Configuration List and TV Setup Menu List contents, click the **Clear** button in the List command section of the FTG File Manager main screen.

8. Transfer the FTG Configuration (.tlx) file to a USB memory device, and proceed to “Teaching FTG Configuration to a TV” on the following page to transfer the FTG Configuration file to an LY560M TV.

FTG Mode of Operation (Cont.)

Teaching FTG Configuration to a TV

This section describes how to transfer (Teach) an FTG Configuration file from a USB memory device to a TV, using the TV Manager / USB Download Menu “Teach To TV (TLX)” option. The FTG Configuration file may be created either in the FTG File Manager or from a Master TV Setup that was saved (Learned) from a Master TV. Refer to “Creating an FTG Configuration File” on pages 46 to 47 for information on creating an FTG Configuration file using the FTG File Manager.

Before You Begin

- Ensure the USB device has been formatted with FAT format.
- You may also use the Ez Download utility to complete the Teaching process, if desired. See “Ez Download Utility” on pages 18 to 20 for further information.
- If the Target TV is currently in Pass-through Mode and you intend to use the TV Zoning feature (i.e., if a Zone has been assigned to the Installer Menu profile in the FTG File Manager or if a TV Zone # was set in the Master TV before a Learning process was initiated), make sure to assign the appropriate TV Zone # in the TV when directed to do so in the procedure below.
- If the FTG Configuration file contains an FTG Channel Map that was created in the FTG File Manager, each logical channel number in the FTG Channel Map has been assigned a physical RF channel or an Aux input (the latter designated by 130-0 through 137-0—see also Reference section, “TV Aux Input Configuration”). When you Teach the FTG Channel Map to the Target TV(s), you will have the option to select either logical or physical channel tuning. If you select physical channel tuning, the physical RF channels and Aux inputs in the FTG Channel Map will remain in logical order.
- If the FTG Configuration file contains an FTG Channel Map that was Learned from a TV, the physical RF channels in the FTG Channel Map have been assigned logical channel numbers (see “Learning FTG Configuration from a TV” on pages 50 to 51). When you Teach the FTG Channel Map to the Target TV(s), you will have the option to select either logical or physical channel tuning. If you select physical channel tuning, the physical RF channels in the FTG Channel Map will remain in logical order.
- If the FTG Configuration file was created in the FTG File Manager, it may contain multiple zoned FTG Installer Menu profiles for different TV models. Make sure it includes the appropriate Installer Menu profile(s) for the Target TV(s) before Teaching.

 **Caution: Do not unplug the TV power cord or remove/disconnect the USB memory device while Teaching, as doing so may cause the TV to malfunction or harm the USB device, respectively.**

Teach FTG Configuration to Target TV

1. Turn ON the Target TV.

If the Express Script Installer Menu wizard appears on the screen when you turn ON the TV, exit the wizard. Then, continue with step 2.

2. If the TV is currently in Pass-through Mode and the FTG Configuration file you are Teaching contains an Installer Menu and/or TV Setup Menu profile with a Zone assignment, either when configured in the FTG File Manager or from the Master TV Setup, make sure to assign the same Zone designation in the Target TV at this time. See Reference section, “Using the TV Zoning Feature,” for further information.

(Continued on next page)



(Continued from previous page)



Note: In order for the proper location-specific TV Zone profile data to be applied, the Zone designation must be assigned in the Target TV(s) BEFORE Teaching is performed.

3. Insert the USB memory device that contains the FTG Configuration file into the USB port.
4. Press **MENU** on the Installer Remote to display the TV setup menus (TV is in Pass-through Mode) or the Function Menu (TV is already in FTG Mode).
5. Use the arrow navigation keys to select/highlight either the **Option** menu icon from the TV setup menus or the **Lock** menu icon from the Function Menu. Then, press the number “7” key a total of seven times to display the TV Manager / USB Download Menu.
6. With the TV Manager / USB Download Menu on display, use the Up/Down arrow keys to select **Teach To TV (TLX)**, and then press **OK**.
7. In the Teach To TV (TLX) window, use the Up/Down arrow keys to select the FTG Configuration file you want to install.

Note: Filenames for TLX files that were Learned from a TV are comprised of the TV model and a five-digit number, for example, xxLY560M-UA00005.TLX.

8. Select the desired Channel Tuning / Channel Banner Display option at the right side of the Teach to TV (TLX) window:
 - Press the green  button on the Installer Remote to select **Logical** tuning, or
 - Press the yellow  button on the Installer Remote to select **Physical** tuning.

A checkmark will appear at the left of the selected option. Logical tuning is selected by default.

9. Press **OK** when you are ready to initiate the Teaching process.

Teaching status will be shown on a progress bar in a new window. Do NOT remove the USB device until Teaching is complete. When the Teaching process is complete, the TV will briefly display a “Teaching Completed” window and then exit the TV Manager / USB Download Menu.

10. Remove the USB memory device from the Target TV, and verify that the FTG Configuration is now resident on the Target TV.

Note: If it was previously in Pass-through Mode, the Target TV CPU is now in FTG Mode.

After the Teaching process is complete, the TV tunes according to the Start Channel setting in the Installer Menu. If a Start Channel is specified, the TV will tune to that channel, though a channel banner will only be displayed if the Start Channel is included in the FTG Channel Map (depending on your selection in step 8, the channel banner will display either the Start Channel’s logical channel number or physical RF channel number). Otherwise, the TV will simply tune to the first channel in the FTG Channel Map. Remember that the channels in the FTG Channel Map are always arranged in logical order, regardless of your selection in step 8.

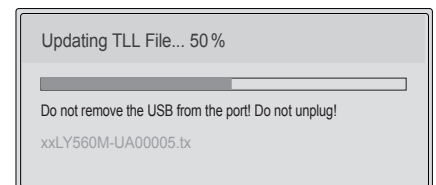
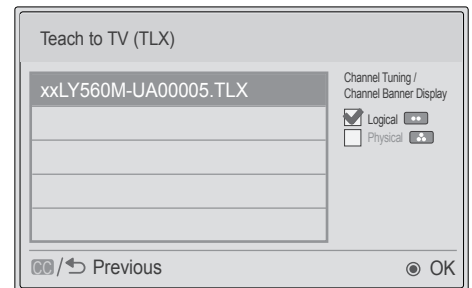
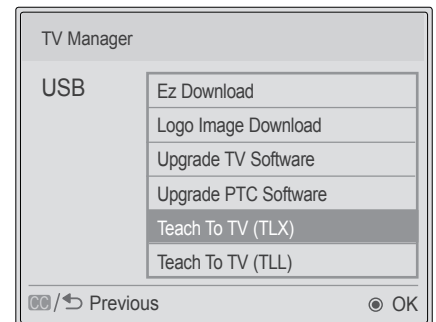

FTG Mode of Operation (Cont.)

Learning FTG Configuration from a TV

To ensure that decryption of Pro:Idiom encrypted channels is enabled, it is recommended that you create an FTG Configuration file using the FTG File Manager as described on pages 46 to 47. However, if necessary, there is an option to save (Learn) an FTG Configuration file from an LY560M TV to a USB memory device.

The option to save (Learn) an FTG Configuration file from a TV may be desirable or required in either or both of the following situations:

- If you want to save customized TV setup menu settings to the FTG Configuration file, in addition to the FTG Channel Map and FTG Installer Menu settings.
- If you do not know the RF channels at the site, and you would like to use the TV to search for the available RF channels.

Before You Begin

- Ensure the USB device has been formatted with FAT format.
- If the TV is NOT already in FTG Mode, you may need to perform some manual configuration on the TV before you start this procedure (see “Optional Manual Configuration / TV Setup” on next page).
- If you intend to use the TV Zoning feature, make sure to assign the appropriate TV Zone # as described in Reference section, “Using the TV Zoning Feature,” BEFORE continuing with the procedure below.

 **Caution: Do not unplug the TV power cord or remove/disconnect the USB memory device while Learning, as doing so may cause the TV to malfunction or harm the USB device, respectively.**

Learn FTG Configuration from Master TV

1. Turn ON the TV, and then insert a USB memory device into the USB port on the Master TV.
2. Press **MENU** on the Installer Remote to display the TV setup menus (TV is in Pass-through Mode) or the Function Menu (TV is already in FTG Mode).
3. Use the arrow navigation keys to select/highlight either the **Option** menu icon from the TV setup menus or the **Lock** menu icon from the Function Menu. Then, press the number “7” key a total of seven times to display the TV Manager / USB Download Menu.
4. To gain access to the “Learn From TV” options in the TV Manager / USB Download Menu, key in the following number sequence on the Installer Remote: **9-8-7-6**.
5. Use the Up/Down arrow keys to select **Learn From TV (TLX)**, and then press **OK**.

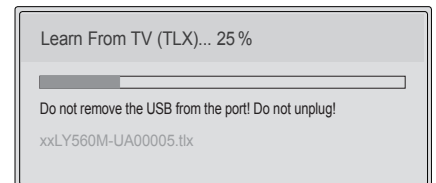
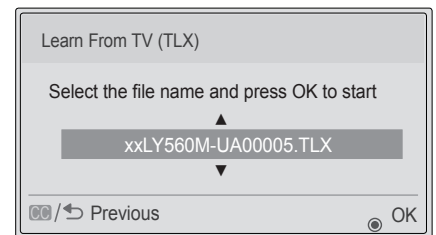
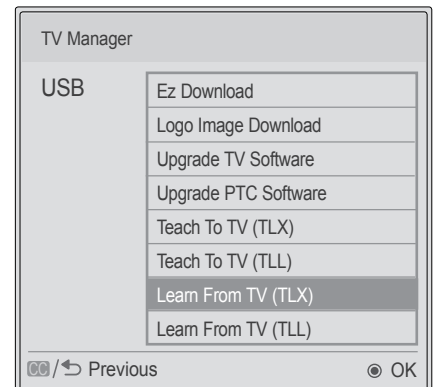

(Continued on next page)

(Continued from previous page)

6. In the Learn From TV (TLX) window, to differentiate this TLX file from others, you can use the Up/Down arrow keys to change the last five digits of the filename. Press **OK** when you are ready to initiate Learning.

Learning status will be shown on a progress bar in a new window. Do NOT remove the USB device until Learning is complete. When the Learning process is complete, the TV Manager / USB Download Menu will reappear on the screen.

7. When Learning is done, press **CC** or **↵** on the Installer Remote to exit the TV Manager / USB Download Menu, and remove the USB memory device.



Note: During Learning, logical channel numbers are automatically assigned in ascending order, starting with 0 (zero), to the physical RF channels of the TV channel lineup. See also note below.



Note: It is highly recommended that you open this FTG Configuration file in the FTG File Manager—BEFORE transferring (Teaching) the file to any Target TVs—to verify FTG Channel Map and FTG Installer Menu settings and enable decryption by marking Pro:Idiom encrypted channels. This will also enable you to confirm channels and add channel attributes, labels, etc.

Optional Manual Configuration / TV Setup

The manual configuration procedures below should only be performed if you want to save customized TV setup menu settings to the FTG Configuration file and/or if you do not know the RF channels at the site and need to “Learn” FTG Configuration from an LY560M TV as described above. Ensure the TV is in Pass-through Mode before you begin.

These configuration procedures parallel the initial steps required for creating a custom Master TV Setup. See also screen examples on pages 32 to 33.

Set Installer Menu Items

These steps provide specific instruction only on the Installer Menu items that should be set on an LY560M TV. Refer to pages 21 to 30 for detailed information on all Installer Menu items.

1. If not done already, turn ON the TV.

If the Express Script Installer Menu Wizard appears on the screen when you turn ON the TV, exit the wizard.

2. Use the Installer Remote to access the PTC Installer Menu (see “Accessing the Installer Menu” on page 21 for further information).

The next step depends on whether the Express Script Installer Menu Wizard appeared when you turned ON the TV:

- If the wizard did appear, the TV is in a factory default state, and you can proceed to set Installer Menu items. Go to step 4.
- If the wizard did not appear, go to step 3.

(Continued on next page)

FTG Mode of Operation (Cont.)

(Continued from previous page)

3. Set Installer Menu item **117 FACT DEFAULT** to **1** and press **OK** on the Installer Remote.
This clears all Installer Menu custom settings, the channel lineup, etc. and restores the factory default settings. The value will change back to 0 after the commercial controller (PTC) has been restored to factory default condition. This step ensures that the TV Channel Memory will be the active channel lineup.
4. Set Installer Menu item **003 BAND/AFC**, as appropriate.
 - Broadcast: Set to 0.
 - HRC: Set to 2.
 - CATV: Set to 1 (default).
 - IRC: Set to 3.
5. Set Installer Menu item **027 HOSPITAL MODE**, as appropriate, to select the speaker configuration. Also, set any other Installer Menu items that affect your TV programming network to the required configuration. For example, enable/disable Aux inputs, set a Start Channel, etc.
You may also configure Pro:Centric settings in the IP Environment Menu (accessible from the Installer Menu). See “IP Environment Setup” on pages 57 to 60 for further information. However, note that you cannot return directly to the Installer Menu from the IP Environment Menu; thus, you may wish to set all Installer Menu items as needed before you access the IP Environment Menu. Otherwise, you will need to reaccess the Installer Menu to set additional items.
6. After you have adjusted all Installer Menu item settings as required, press **OK** once on the Installer Remote to save your changes; then, press **OK** again to exit the menu.

Set Up TV Features

On-screen setup menus control the features of the TV. Press **MENU** on the Installer Remote to access the TV setup menus, and then set Channel, Picture, Audio, Time, etc. options to the desired configurations. In particular, if you intend to use the TV Zoning feature, make sure to assign the appropriate TV Zone # in this TV as described in Reference section, “Using the TV Zoning Feature.”

Run Auto Tuning (Channel Search)

Note: Decryption of Pro:Idiom encrypted channels will not be enabled unless you use the FTG File Manager to set the channel attributes.

1. Search for all available analog and digital channels: Use the Installer Remote to go to the Channel Menu, select the **Auto Tuning** option, and follow the on-screen instructions.
2. Use the **Channel Edit** option in the Channel Menu to edit the channel lineup, as necessary. Add/delete channels per your system requirements.

Once you have completed these procedures, return to “Learning FTG Configuration from a TV” above to complete the Learn sequence.

FTG File Manager Utilities Overview

FTG File Manager Main Screen

The FTG File Manager main screen enables you to compile, modify, and save FTG Configuration (.tlx) files. It also allows you to change the Zone assignment for each Installer Menu profile, if desired (see Reference section, “Using the TV Zoning Feature,” for further information).

The screenshot shows the FTG File Manager interface with the following callouts:

- FTG CONFIGURATION LIST**: Data to be saved in FTG Configuration (.tlx) file.
- CLEAR/SAVE**: FTG Configuration and TV Setup Menu List options.
- NEW/OPEN**: TLX File options.
- Filename of opened FTG Configuration (.rml) file created using FTG Device Configuration Application.**: Points to the 'FTG File:' text box.
- Copy FTG Channel Map to and from FTG Configuration List.**: Points to the 'FTG Channel Map' section.
- Copy FTG Installer Menu settings to and from FTG Configuration List.**: Points to the 'FTG Installer Menu Settings' section.
- Load default FTG Installer Menu for appropriate LY560M chassis.**: Points to the 'Installer Menu Templates' section.
- TV SETUP MENU LIST**: Data to be saved in FTG Configuration file.
- TLX FILE CONTENTS**: Data contained in opened FTG Configuration (.tlx) file.

The interface includes sections for 'FTG Channel Map', 'FTG Installer Menu Settings', 'Installer Menu Templates', 'FTG Configuration List', 'TV Setup Menu List', and 'TLX File Contents'.



Note: The data referenced in the FTG Configuration List is only a snapshot of the current FTG Channel Map and FTG Installer Menu settings when copied to the list. If you make any change(s) to the current data to be included in the FTG Configuration List, you will need to recopy Channel Map and Installer Menu settings to the FTG Configuration List.

FTG File Manager Utilities Overview (Cont.)

FTG Channel Map Editor

The FTG Channel Map Editor shows a single Logical Channel's data and the FTG Channel Map.

LOGICAL CHANNEL MAPPING

Select a Logical Channel number. Then, assign it the RF, Major, and Minor channel numbers to complete the mapping.

CUSTOM CHANNEL LABELS/ICONS

Enter custom labels and select icons by name on menu or by number.

SET CHANNEL ATTRIBUTES

Check/select Encrypted, OSD, or Blank Video.

ZONE RESTRICTION

Select Zone restriction for channel. See Reference section, "TV Zone Restrictions," for further information.

ADD

After defining a new Logical Channel, click to add channel to the FTG Channel Map.

EXIT

Click to exit editor and return to FTG Channel Map Configuration Utility.

UPDATE

After editing an existing Logical Channel's data, click to commit the changes in the FTG Channel Map.

DELETE

Click to remove highlighted channel from FTG Channel Map.

FTG File Manager Utilities Overview (Cont.)

FTG Installer Menu Configuration Utility

CONFIGURATION SETTINGS

Select tabs for categories of Installer Menu items to set up TV.

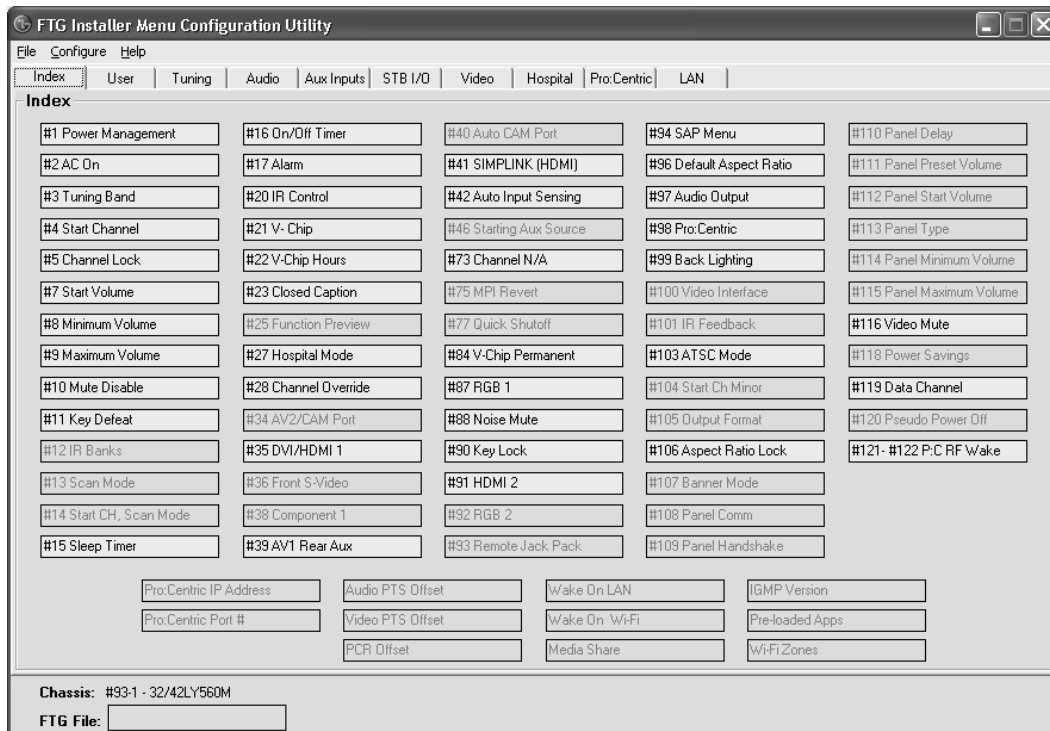

Filename of opened FTG Configuration (.rml) file created using FTG Device Configuration Application.

Notes:

- The Pro:Centric tab enables you to set up Pro:Centric-specific parameters. Refer to the **Free-To-Guest (FTG) File Manager User Guide** for further information.
- LAN parameters are not applicable for these TV models.

The IP Environment Menu enables you to set up the network features of the TV. With the exception of Network Connection settings, the IP Environment settings are editable (with the Installer Remote) only if the TV is in Pass-through Mode and read-only when the TV is not in Pass-through Mode. Also, if you intend to create a Master TV Setup for cloning purposes (using a TLX file—see Master TV Setup procedure on pages 31 to 35), all IP Environment settings, with the exception of the Network Connection settings, may be cloned.

Accessing the IP Environment Menu

1. Use the Installer Remote to access the Installer Menu (see “Accessing the Installer Menu” on page 21 for further information).
2. Navigate to Installer Menu item 119 DATA CHANNEL, and press **2-5-3 + MENU** to launch the IP Environment Menu (see example at right).

Use the Up/Down arrow keys on the Installer Remote to select the desired menu option and then press **OK**. Refer to the following sections for information on each of the IP Environment setup options.

When you have completed your IP Environment configuration as required, press **EXIT** or **↵** on the Installer Remote to exit the IP Environment Menu.

Configuring the Network Connection

This option enables you to set up the TV’s wired network connection.

1. With the IP Environment Menu on display, use the arrow keys on the Installer Remote to select **Network Connection**. Then, press **OK**.
The first of a series of Network Setting windows will be displayed on the screen.
2. If not already done, connect the appropriate cable between the TV and the network. Then, use the arrow keys on the Installer Remote to select **Start Connection** and press **OK**.
3. By default, the TV is configured for DHCP. If configured, the DHCP server will assign an IP address to the TV once the TV successfully connects to the network, and a “Wired network is connected” message will be displayed at the top of the next Network Setting screen (see example at right).
 - If no further network configuration is required, use the arrow keys on the Installer Remote to select **Complete** and press **OK** to return to the IP Environment Menu.
 - If a DHCP server is not configured and/or if you wish to set static IP configuration data for the TV, continue with step 4.
4. Use the arrow keys on the Installer Remote to select **Set Expert** from the Network Setting screen, and then press **OK**.

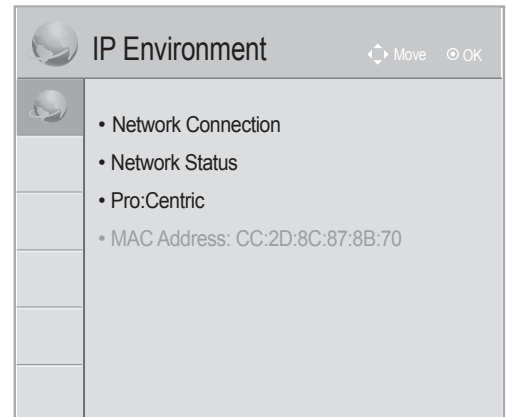

Note: When you enter the IP Environment Menu, the Installer Menu is exited. If you are also in the process of updating Installer Menu items, you may wish to set all items as needed before you access the IP Environment Menu. Otherwise, you will need to reaccess the Installer Menu to set additional items.

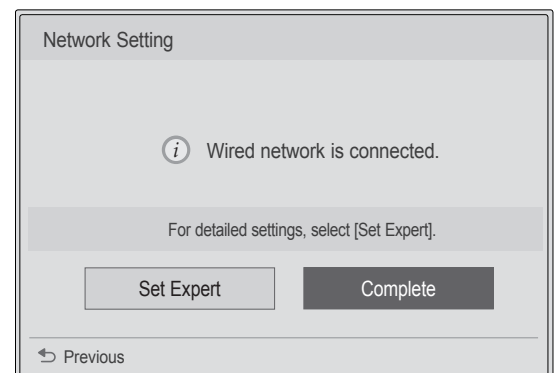
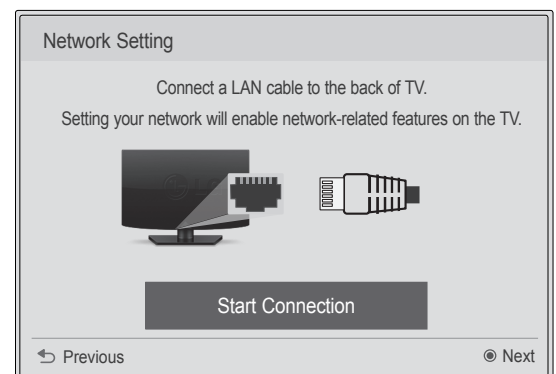

(Continued on next page)

IP Environment Setup (Cont.)

(Continued from previous page)

The next Network Setting window will enable you to specify the IP and DNS configuration for this TV. Auto settings will be selected by default. Use the arrow keys to select the appropriate options, and specify the configuration data for the IP and DNS modes. When all fields are completed, select **OK** on the screen and press **OK** on the Installer Remote.

Note: You can specify a static DNS server with an auto-configured IP address but not vice versa.

The TV will attempt to connect to the network and you will see a progress screen that indicates status as each network element is confirmed. When the network is connected successfully, a “Wired network is connected” message will be displayed at the right of the screen, along with the network configuration data (see example at right below).

5. Select **Complete** (if not already selected), and then press **OK** on the Installer Remote to return to the IP Environment Menu.

Note: If the network connection is not successful, the progress screen will identify the network element in which the connection failed. Check your cabling and/or, if necessary, press **↵** on the Installer Remote to verify the configuration data.

Network Status

This option enables you to check the status of the network connection.

1. With the IP Environment Menu on display, use the arrow keys on the Installer Remote to select **Network Status**. Then, press **OK**.

The TV will display a status screen as it confirms each of the network elements—TV, Gateway, DNS, and Internet (see example at right). If the network is connected successfully, a “Wired network is connected” message will be displayed at the right of the screen, along with the network configuration data.

Note: If a problem is detected, the status screen will identify the network element in which the connection failed. Check cabling and/or configuration data, as necessary. If the status screen is still on display, you can select **Test** and press **OK** to recheck the network status.

2. When the status screen shows that the network is connected, select **Complete** (if not already selected) and press **OK** on the Installer Remote to return to the IP Environment Menu.

Note: If you wish to cancel the status check while it is in progress, select “Close” or press **↵** to return to the IP Environment Menu.

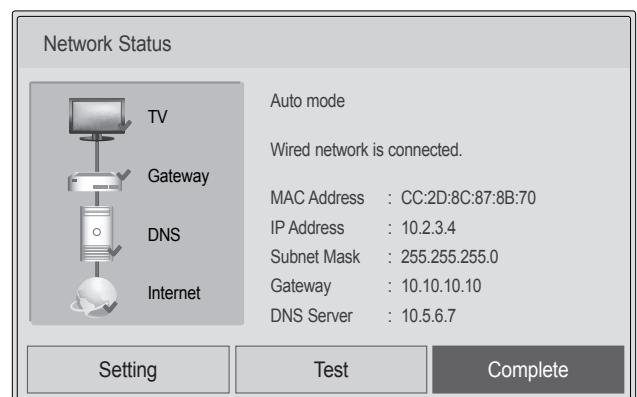
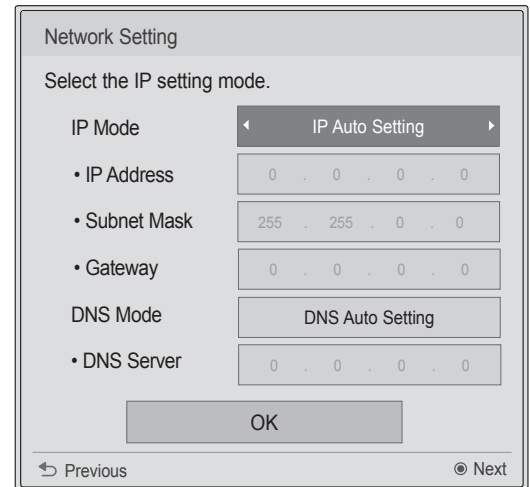

Pro:Centric Setup

Pro:Centric options enable you to configure the TV with the appropriate settings to connect to the Pro:Centric server. Use the Up/Down arrow keys on the Installer Remote to navigate between fields.

1. With the IP Environment Menu on display, use the arrow keys on the Installer Remote to select **Pro:Centric**. Then, press **OK**.

Note: Options that are initially grayed out/inaccessible in the Pro:Centric Menu are dependent upon other settings in the display. For example, if “IP” is selected in the Media Type field, the Server IP and Port Number fields become accessible.

2. Refer to the appropriate subsection(s) below to configure the TV’s Pro:Centric settings to match those of the Pro:Centric server.

While the Pro:Centric application (Mode) itself is an additional feature, the appropriate Pro:Centric server configuration must be completed to enable TV E-Z Installation (splash screen, configuration, and/or firmware) data downloads and, if configured, the Pro:Centric application download.

Note: For those fields that permit direct entry of numerical values (for example, Server IP, Port Number, Data Channel, etc.), once you key in the maximum number of digits allowed in the highlighted field, the next available field will be highlighted.

RF Configuration

- a) In the Media Type field, use the Left/Right arrow keys to select **RF**.

Note: If the Media Type has already been set in the Express Script Installer Menu Wizard, the specified value will be reflected in this field.

- b) In the Data Channel field, either key in or use the Left/Right arrow keys to select the RF channel number that will be used by the Pro:Centric server as its data channel. The Data Channel value can be set from 0 (disabled) to 135.*

For TVs in Pass-through Mode or FTG Mode, if this item is left at its default value (255), the TV’s Data Channel Auto Search feature will be enabled. See Installer Menu item 119 DATA CHANNEL description on page 30 for further information.

Note: If the Data Channel has already been set in the Installer Menu (Installer Menu item 119) or in the Express Script Installer Menu Wizard, the specified channel will appear in this field. If you change the Data Channel in this menu, Installer Menu item 119 will now show the value you entered here.

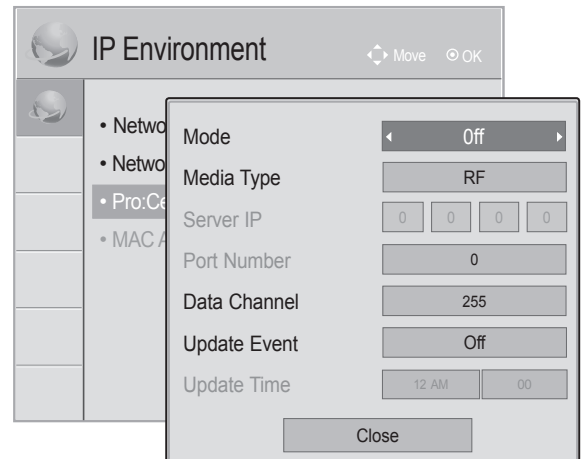

(Continued on next page)

* PCS150R and later Pro:Centric servers do not support HRC or IRC cable channel frequencies.

IP Environment Setup (Cont.)

(Continued from previous page)

IP Configuration

- a) In the Media Type field, use the Left/Right arrow keys to select **IP**.

Note: If the Media Type has already been set in the Express Script Installer Menu Wizard, the specified value will be reflected in this field.

Note: Setting the Media Type to “IP” automatically sets the Data Channel field to “253.” You cannot alter this setting (unless you revert Media Type to “RF”). Also, it is not possible to directly enter “253” in the Data Channel field.

- b) In the Server IP and Port Number fields, either key in or use the Left/Right arrow keys to select the appropriate values for the Pro:Centric server IP address and port number. The IP address must match the IPv4 multicast address and the port number must match the port number that is set in the Pro:Centric server.

Note: If the server IP address and port number have already been set in the Express Script Installer Menu Wizard, the specified data will be reflected in these fields.

Pro:Centric Application Mode Configuration

In the Mode field, use the Left/Right arrow keys to select the appropriate Pro:Centric Application Mode setting—**Off**, **FLASH**, or **GEM**. If the Pro:Centric Mode is set to “Off,” Pro:Centric application data will not be downloaded.

Note: If the mode has already been set in the Installer Menu (item 098 PRO:CENTRIC) or in the Express Script Installer Menu Wizard, the specified mode will be reflected in this field. If you change the mode in this menu, Installer Menu item 098 will now reflect the value you selected here.

3. In the Update Event field, use the Left/Right arrow keys to select **On** or **Off**, as required. Based on the Update Time settings, the Wake For Update feature wakes the TV once daily to check for, and if applicable, download updates from the Pro:Centric server. See Installer Menu item 121 UPDATE TIME HR description on page 30 for additional information on Wake For Update functionality. If you set Update Event to “On,” specify the appropriate Wake For Update time in the Update Time fields, as desired. Note that the Update time set in this menu is based on a 12-hour clock. Ensure the AM/PM specification is set accordingly.
4. Once all fields are completed as required, either select **Close** and then press **OK** on the Installer Remote or press **↵** to return to the IP Environment Menu.

Reference: Upgrading TV/PTC Software using a USB Memory Device

This section describes how to update TV (CPU) and/or PTC software using the TV Manager / USB Download Menu “Upgrade TV Software” and/or “Update PTC Software” option(s), respectively, though you may also use the Ez Download utility to upgrade software, if desired. See “Ez Download Utility” on pages 18 to 20 for further information.

Before You Begin

- Software upgrade files must be stored in a folder named “LG_DTV” in the root directory of the USB memory device.
- Ensure the USB device has been formatted with FAT format.

Upgrade the TV/PTC Software

Note: You can check the TV/PTC software versions by accessing the Installer Menu with the Installer Remote. See “Accessing the Installer Menu” on page 21 for further information. PTC and CPU versions are displayed in the Installer Menu footer.

Note for TV CPU Software Upgrade only: If the TV detects a later version of software on the USB device, it will automatically display a dialog from which you can start the software upgrade immediately. Otherwise, you can close the dialog, and access the TV Manager / USB Download Menu as described below.

1. Turn ON the TV, and then insert the USB memory device into the TV’s USB port.
2. Press **MENU** on the Installer Remote to display the TV setup menus (TV is in Pass-through Mode) or the Function Menu (TV is not in Pass-through Mode).
3. Use the arrow navigation keys to select/highlight either the **Option** menu icon from the TV setup menus or the **Lock** menu icon from the Function Menu. Then, press the number “7” key a total of seven times to display the TV Manager / USB Download Menu.
4. With the TV Manager / USB Download Menu on display, use the Up/Down arrow keys to select **Upgrade TV Software** or **Upgrade PTC Software**, as applicable, and then press **OK**.
5. In the next window (TV Software Update or Upgrade PTC Software depending on your selection in step 4—see also screen samples at right), use the Up/Down arrow keys to select/highlight the update file to download. Then, press **OK**.

Note: Do not select Forced Update options unless you have been specifically instructed to do so or have previous experience with Expert Software Updates.

The TV will show update completion progress in a new window. Do NOT remove the USB device until the software upgrade is complete. When the software upgrade is complete, the TV will briefly display a “Updating complete” window and then reset itself with an automatic restart.

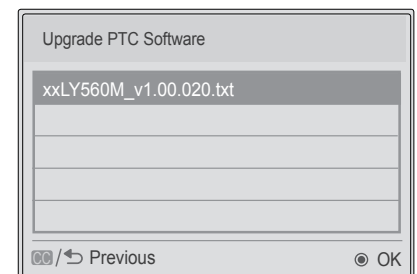
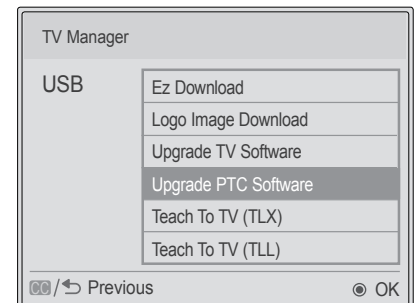
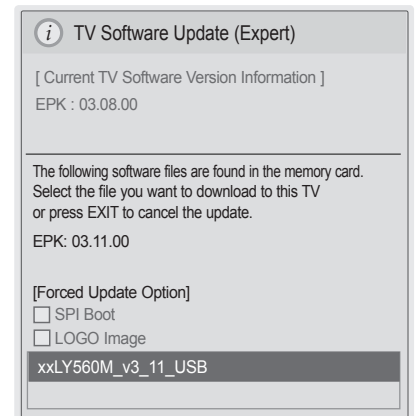
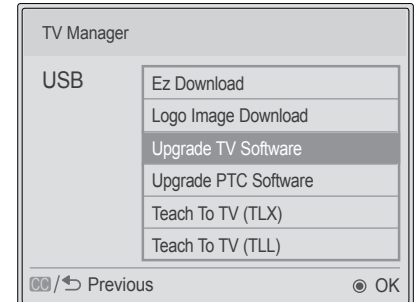

Reference: Downloading a Splash Screen using a USB Memory Device

This section describes how to download a splash screen image using the TV Manager / USB Download Menu “Logo Image Download” option, though you may also use the Ez Download utility to download the splash image, if desired. See “Ez Download Utility” on pages 18 to 20 for further information.

Splash Screen Image File Guidelines

- The splash screen image must be a baseline (not progressive) JPEG.
- The image should be no larger than 1 MB.
- The maximum resolution allowed for a 22/28/32LY560M splash screen image is 1360 x 768 pixels (HD)
- The maximum resolution allowed for a 42LY560M splash screen image is 1920 x 1080 pixels (FHD).
- Avoid using special characters, such as ?, -, etc., in the splash screen image file name.

Before You Begin

- The splash screen image file must be stored in a folder named “LG_DTV” in the root directory of the USB memory device.
- Ensure the USB device has been formatted with FAT format.

Download the Splash Screen Image

1. Turn ON the TV, and then insert the USB memory device into the TV’s USB port.
2. Press **MENU** on the Installer Remote to display the TV setup menus (TV is in Pass-through Mode) or the Function Menu (TV is not in Pass-through Mode).
3. Use the arrow navigation keys to select/highlight either the **Option** menu icon from the TV setup menus or the **Lock** menu icon from the Function Menu. Then, press the number “7” key a total of seven times to display the TV Manager /USB Download Menu.
4. With the TV Manager / USB Download Menu on display, use the Up/Down arrow keys to select **Logo Image Download**, and then press **OK**.
5. In the Logo Image Download window, use the Up/Down arrow keys to select the image file to download, and then press **OK**.

The TV will show download completion progress in a new window. Do NOT remove the USB device until the image download is complete. When the image download is complete, the TV will briefly display a “Updating complete” window and then reset itself with an automatic restart. Upon the restart, you should see the new splash screen.

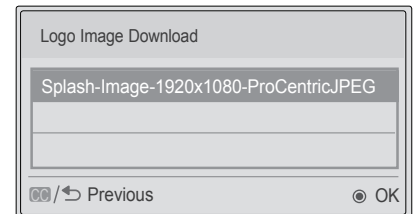
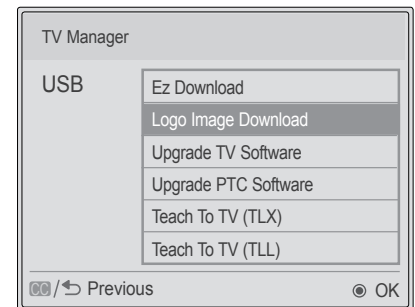

Reference: Power Consumption Settings

The following tables assume that Installer Menu item 099 BACK LIGHTING is set as shown below (default value is 255).

Item 099 Back Lighting (Static)	22LY560M		28LY560M		32LY560M		42LY560M	
	Power Consumption (Watts)	Percent Savings	Power Consumption (Watts)	Percent Savings	Power Consumption (Watts)	Percent Savings	Power Consumption (Watts)	Percent Savings
100	20.7	0%	22.5	0%	43.6	0%	72.0	0%
90	20.4	1%	21.4	5%	40.5	7%	66.7	7%
80	20.3	2%	21.2	6%	37.7	14%	62.1	14%
70	20.2	2%	20.7	8%	34.6	21%	57.1	21%
60	20.0	3%	20.2	10%	33.5	23%	55.0	24%
50	19.8	4%	19.5	13%	32.3	26%	53.3	26%
40	19.5	5%	19.0	16%	30.5	30%	50.0	31%
30	18.6	10%	17.0	24%	28.8	34%	47.4	34%
20	17.6	15%	15.4	31%	23.7	46%	38.8	46%
10	16.1	22%	13.5	40%	18.7	57%	30.1	58%
1	14.8	28%	12.1	46%	14.2	67%	22.4	69%

Item 099 Back Lighting (Dynamic)	22LY560M		28LY560M		32LY560M		42LY560M	
	Power Consumption (Watts)	Percent Savings	Power Consumption (Watts)	Percent Savings	Power Consumption (Watts)	Percent Savings	Power Consumption (Watts)	Percent Savings
200	20.6	0%	22.4	0%	44.4	0%	72.2	0%
190	20.4	1%	21.4	4%	41.2	7%	66.9	7%
180	20.3	1%	21.1	6%	38.4	14%	62.2	14%
170	20.1	2%	20.6	8%	35.3	20%	57.1	21%
160	20.0	3%	20.2	10%	34.1	23%	55.1	24%
150	19.8	4%	19.5	13%	33.0	26%	53.3	26%
140	19.6	5%	18.9	15%	31.2	30%	50.1	31%
130	18.5	10%	16.9	24%	28.9	35%	47.2	35%
120	17.6	15%	15.5	31%	23.8	46%	38.7	46%
110	16.2	22%	13.5	40%	18.7	58%	30.0	58%
101	14.9	28%	12.1	46%	14.3	68%	22.1	69%

Note: Values are results of controlled experiments under laboratory conditions.

Reference: TV Aux Input Configuration

DIRECT ACCESS Tuning *		TV		ENABLE					MPI DATA				Installer Menu Item 046 START AUX SRCE (Start Aux Source) Value
				Installer Menu			MPI DATA STATUS TYPE 0x41 SOURCES ENABLED (R/W)		DATA STATUS TYPE 0xD2 CURRENT AV SOURCE (R)		DATA STATUS TYPE 0x0D AUX SOURCE (R)		
Installer Menu Item 029 OLD OCV = 0	Installer Menu Item 029 OLD OCV = 1	Aux Input	Input Mode	Item	Function	Value	Enable Bit	Label	Value	Value	Description		
131	91	Video1 (Rear)	CV	39	REAR AUX EN	1	1	Rear Video (Aux)	1	0	VIDEO	1	
132	92	HDMI2	DTV	91	HDMI2 ENABLE	1	2	S-Video Rear	2	0	VIDEO	5	
			PC			2				2	COMPUTER		
133	93	HDMI1	DTV	35	HDMI1 ENABLE	1	3	Front Computer	3	0	VIDEO	3	
			PC			2				2	COMPUTER		
134	94	RGB	PC	87	REAR RGB EN	1	5	SVGA Rear Computer	4	2	COMPUTER	4	

* Use Installer Remote to enter channel number indicated based on OLD OCV Installer Menu setting.

Reference: Auto Input(s) Sensing Feature

This section provides detailed settings information for Installer Menu item 042 AUTO INPUTS. To disable auto-sensing for all available Aux inputs, set item 042 to 0. To enable auto-sensing for all available Aux inputs, set item 042 to 255. For specifications on all other available settings (i.e., settings for individual inputs), refer to the table on the following page.

Note: When both item 042 AUTO INPUTS *and* item 041 SIMPLINK EN are enabled in the Installer Menu, HDMI inputs will be detected by SIMPLINK, but the Auto Input(s) Sensing Feature will not function.

In the Installer Menu, an informational code is displayed at the right of each Auto Inputs value, for example:

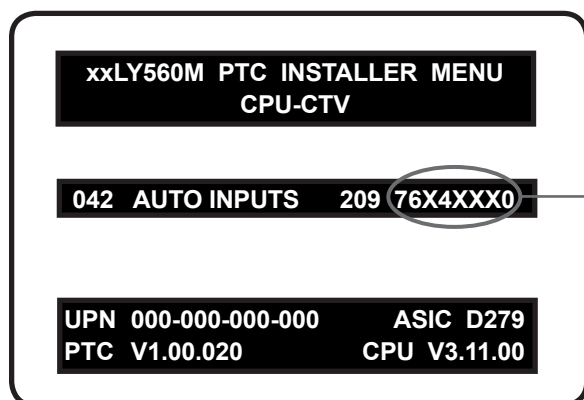

AUTO INPUTS Display Code

This example illustrates Installer Menu item 042 value 209, which enables auto-sensing for all available Aux inputs. The input #s in the display code (7, 6, 4, 0 in this example) identify the enabled Aux inputs. See table below for a listing of the LY560M Aux inputs and their corresponding display code input #s. The table on the following page shows the display codes for all item 042 values.

Each code consists of eight characters that identify the Aux input(s) for which auto-sensing is enabled. The following table identifies the Installer Menu display code Input # for each Aux input that is available on the LY560M TV models. The table also identifies the Installer Menu item associated with each Aux input. Remember that in order for auto-sensing to be enabled for an input, that input must also be enabled in the Installer Menu.

Installer Menu Display Code Input #	Aux Input	Installer Menu	
		Item	Function
0	AV1	039	REAR AUX EN
4	RGB	087	REAR RGB EN
6	HDMI 1	035	HDMI1 ENABLE
7	HDMI 2	091	HDMI2 ENABLE

Reference: Auto Input(s) Sensing Feature (Cont.)

Item 042 Value	Inputs				Installer Menu Display
	AV1	RGB	HDMI 1	HDMI 2	
001	Enabled	Disabled	Disabled	Disabled	DDXDXXX0
016	Disabled	Enabled	Disabled	Disabled	DDX4XXXD
017	Enabled	Enabled	Disabled	Disabled	DDX4XXX0
064	Disabled	Disabled	Enabled	Disabled	D6XDXXXD
065	Enabled	Disabled	Enabled	Disabled	D6XDXXX0
080	Disabled	Enabled	Enabled	Disabled	D6X4XXXD
081	Enabled	Enabled	Enabled	Disabled	D6X4XXX0
128	Disabled	Disabled	Disabled	Enabled	7DXDXXXD
129	Enabled	Disabled	Disabled	Enabled	7DXDXXX0
144	Disabled	Enabled	Disabled	Enabled	7DX4XXXD
145	Enabled	Enabled	Disabled	Enabled	7DX4XXX0
192	Disabled	Disabled	Enabled	Enabled	76XDXXXD
193	Enabled	Disabled	Enabled	Enabled	76XDXXX0
208	Disabled	Enabled	Enabled	Enabled	76X4XXXD
209	Enabled	Enabled	Enabled	Enabled	76X4XXX0

X = Aux input source is Disabled or Not Available (i.e., on this TV model)

D = Auto-sensing for input is Disabled

Input # = Auto-sensing for input is Enabled

Reference: LY560M Hospital Operations

Hospital Features

The following table identifies when and how the LY560M hospital features are supported in three different TV configurations. As indicated in the introduction to this document, LG commercial TV functionality is based on “ownership” of the Channel Map. For the purposes of this table, “CPU” indicates that the TV is in Pass-through Mode with the Channel Map in the CPU (i.e., auto-tuned/edited channel lineup) and “PTC” indicates that the TV is in Pass-through Mode with the Channel Map in the PTC (i.e., after 2-5-5 + MENU).

Hospital Mode State	Item	CPU		PTC		FTG/PPV Mode	
		Disabled	Enabled	Disabled	Enabled	Disabled	Enabled
Installer Menu	Item						
IR Banks Enable	012				X		
Scan Mode	013	(a)	(a)	X	X		
Start Channel in Scan Mode	014			X	X		
Feature Level	020						
Bed 1/Bed 2	020	X		X		X	
Multi-code IR	020	X	X	X	X	X	X
Speaker	020	X		X		X	
Function Preview	025			X	X		
Hospital Mode	027						
Bed 1/Bed 2	027		X		X		X
Pillow Speaker Voltage	027	(b)	X	(b)	X	(b)	X
Speaker	027		X		X		X
Quick Shutoff	077	(c)	(c)	(c)	(c)		
Channel Banks							
Number of Banks Enabled				1	4		
Channel Preview/Banks Setup Menu				X	X		
Blanked Channel				X	X	X	X
Inactive TV					X		
SAP Key					X		
Aux Input Sources							
Input List Menu		X	X	X		X	X
Aux in Scan List				X	X	(d)	(d)
TV Setup Menus							
Audio (TV Speaker)		(e)	(e)	(e)	(e)		
Option (Power Indicator)		X	X	X	X		

X = feature supported

a) Turn ON function only. Always goes to channel 2-0.

b) Defaults to Zenith pillow speaker code/(+12v) supply voltage.

c) Quick Shutoff feature only functions when Scan Mode is enabled and if you are using an analog pillow speaker.

d) Dependent upon installer-defined FTG/PPV Channel Map.

e) Audio Menu is only accessible when the speaker selected is TV Only or both TV & Pillow.

Reference: LY560M Hospital Operations (Cont.)

Speaker Selection

The following table outlines speaker settings as determined by Installer Menu items 027 HOSPITAL MODE and 020 FEATURE LEVEL.

Item 027 HOSPITAL MODE Value	Item 020 FEATURE LEVEL Value	Audio Menu TV Speaker	Speaker
0	0 ~ 24	OFF	None
0	0 ~ 24	ON	TV Only
0	64 ~ 65	N/A	Pillow Only
1 ~ 34	N/A	N/A	Pillow Only
65 ~ 98	N/A	OFF	None
65 ~ 98	N/A	ON	TV Only
129 ~ 162	N/A	OFF	Pillow Only
129 ~ 162	N/A	ON	Pillow & TV

Note: If the TV is in FTG Mode, the Audio Menu is no longer accessible.

Reference: Restoring Factory Defaults on the TV(s)

This section describes how to restore all factory defaults or just the Installer Menu factory defaults either on a single TV that is currently in Pass-through or FTG Mode or on multiple TVs that are currently in FTG Mode.

Note: If the TV(s) is/are currently in FTG Mode, restoring the factory defaults also resets the TV to Pass-through Mode.

Installer Menu Item 117 FACT DEFAULT

If the TV is currently in Pass-through Mode, you can set Installer Menu item 117 FACT DEFAULT to 1 to restore the Installer Menu factory defaults and clear the channel lineup, including any assigned channel icons and custom text labels.

Factory “IN-STOP”

If the TV is currently in FTG Mode, a predefined value for Installer Menu item 117 FACT DEFAULT enables access to initiate a factory “IN-STOP” process that will restore the TV to Pass-through Mode in addition to restoring all factory defaults. The “IN-STOP” will also reactivate the Express Script Installer Menu Wizard. Contact technical support for the required value for Installer Menu item 117 and for additional information on performing the IN-STOP from the Installer Menu.

Additional FTG Mode Options

There are two additional options for restoring Pass-through Mode/Installer Menu factory defaults on TVs that are in FTG Mode. The first enables you to restore a single TV to Pass-through Mode, while the second enables you to restore multiple TVs to Pass-through Mode at one time. However, both options require that you create a “Zero Mapped Channels” FTG Configuration (.tlx) file, i.e., an FTG Configuration file with no data. Refer to the ***Free-To-Guest (FTG) File Manager User Guide*** for further information.

- Using a USB memory device, “Teach” a “Zero Mapped Channels” FTG Configuration (.tlx) file to the TV. Refer to “Teaching FTG Configuration to a TV” on pages 48 to 49 of this document for further information on the Teaching process.
- If your system uses a Pro:Centric server for remote management, use the Pro:Centric server Admin Client to load a “Zero Mapped Channels” FTG Configuration (.tlx) file on the Pro:Centric server. Refer to the ***Pro:Centric Server Admin Client User Guide*** for further information.

Reference: Using the TV Zoning Feature

This section describes the TV Zoning feature available with the LY560M model TVs. The TV Zoning feature enables you to create localized configurations for TVs in selected locations, or “Zones,” within the installation environment, for example, a hotel lobby, fitness center, restaurant, etc. This feature is primarily intended for use when the TV is configured for FTG Mode operation. However, selected elements of TV Zoning (Installer Menu and TV Setup Menu profile Zone assignments) may also be used with TV cloning processes using a USB memory device / TLX file.

Refer to the appropriate section(s) below for further information on the TV Zoning feature and how to set the TV Zone # in a TV that is currently in Pass-through Mode.

Using the TV Zoning Feature with FTG Mode via CPU Configuration

The FTG File Manager may be used to create an FTG Configuration (.tlx) file that contains multiple Installer Menu and TV Setup Menu profiles, each with its own Zone assignment. Up to nine unique Zones can be designated for LY560M FTG Installer Menu and/or TV Setup Menu profiles. Zone restrictions can also be placed on individual channels in the FTG Channel Map. Thus, for example, you may create an FTG Installer Menu and/or TV Setup Menu profile to specifically configure a TV in the hotel lobby and also restrict the channels that are available to be tuned on that TV.

The TV Zone # must be set appropriately on each TV in order for the TVs to be configured correctly. See “Set the TV Zone # in the TV” on the following page, and set the TV Zone # in all the TVs in a select area, so that the TVs are configured with corresponding FTG Installer Menu and/or TV Setup Menu settings and/or can omit channels that have been restricted in the FTG Channel Map. TV Zone 0 is the default TV Zone #.

The following subsections briefly describe how to assign Zone designations in the FTG File Manager. Refer to the ***Free-To-Guest (FTG) File Manager User Guide*** for further information.

FTG Installer Menu Profile Zone Assignments

The FTG File Manager main screen enables you to change the Zone assignment (default = Zone 0) for each Installer Menu profile to be included in an FTG Configuration (.tlx) file. For example, you may wish to create one LY560M Installer Menu profile for the hotel lobby and another LY560M Installer Menu profile for the fitness center, both of which are different from the FTG Installer Menu profile used for standard guest rooms. The TV Zoning feature enables you to save multiple LY560M FTG Installer Menu profiles, each with its own Zone assignment, in one FTG Configuration (.tlx) file. If each TV in the aforementioned locations (Zones) has had its TV Zone # set appropriately, as described in the procedure on the following page, the TV(s) will only be configured by the Installer Menu profile that matches its(their) Zone setting.

In the FTG File Manager main screen, you can also edit the Zone assignment for each Installer Menu profile and/or TV Setup Menu profile already present in the FTG Configuration List and TV Setup Menu List windows.

Note: See also the FTG File Manager main screen overview on page 53. In addition, note that TV Setup Menu profiles cannot be created in the FTG File Manager; they must be “Learned” from a TV.

FTG Channel Map Zone Restrictions

The FTG Channel Map Editor in the FTG File Manager’s FTG Channel Map Configuration Utility enables you to place Zone restrictions on individual channels that may be prohibited or deemed unsuitable for selected locations. In the FTG Channel Map Editor, one or more Zone restrictions (1–8) may be placed on each channel that is to be restricted. For example, if you wish to restrict a channel from Zones 2 and 4, select both “Zone 2” and “Zone 4” in the Zone Restriction section of the FTG Channel Map Editor screen when defining or editing that channel.

Reference: Using the TV Zoning Feature (Cont.)

Note: While a channel can be restricted from up to eight Zones, a TV can only ever be in (set for) one Zone. See also the FTG Channel Map Editor overview on page 55.

At the same time, keep in mind that the TV Zone designations are not mutually exclusive. That is, you may opt to place Zone restrictions on selected channels in the FTG Channel Map, but at the same time, you can choose to configure all TVs at the site with the same Installer Menu and/or TV Setup Menu settings. For example, an FTG Configuration (.tlx) file being used to configure the TVs at a site may contain multiple Installer Menu and TV Setup Menu profiles with different Zone assignments, as well as an FTG Channel Map with Zone restrictions on several channels. Each TV that still has the default TV Zone 0 setting will *only* be configured by the Installer Menu and/or TV Setup Menu profile(s) with a Zone 0 designation. If, on the other hand, the TV Zone # is set to 1, the TV will first look in the file for the LY560M Installer Menu and/or TV Setup Menu profile(s) with a Zone 1 designation. If none of the LY560M Installer Menu and/or TV Setup Menu profiles has a Zone 1 designation, the TV will then look for the LY560M profile(s) with a Zone 0 designation. For the FTG Channel Map configuration, when the TV Zone # is set to 0, the TV will ignore any Zone restrictions (1–8) that may be placed on channels in the FTG Channel Map. However, when the TV Zone # is set to 1, the TV will omit any channels that have been restricted from Zone 1 in the FTG Channel Map.

Using the TV Zoning Feature with Cloning Configuration

A location-specific configuration / TLX file may be saved (Learned) from an individual TV as part of a Master TV Setup and then be used during Teaching. For example, if the TV Zone # in the Master TV is set to 3 before Learning is initiated, the Master TV's Installer Menu and TV Setup Menu profiles will be saved with the TV Zone 3 assignment when Learning is completed. In order to configure the Target TVs with the Zone 3 Installer Menu and TV Setup Menu profiles Learned from the Master TV, you must set the TV Zone # accordingly in the Target TVs before transferring (Teaching) the Master TV Setup. See “Set the TV Zone # in the TV” below. Also, see “Learning / Teaching a Master TV Setup using a TLX File” on pages 41 to 43 for additional information on the cloning processes. TV Zone 0 is the default TV Zone #.

Set the TV Zone # in the TV

Use the following procedure to set a TV Zone # in the TV. Note that this procedure can only be performed while the TV is in Pass-through Mode.

1. Turn ON the TV.
2. Press **MENU** on the Installer Remote, and use the arrow navigation keys to select/highlight the **OPTION** menu option. Then, press **OK**.
3. Use the Up/Down arrows to select **Zone**, and then press **OK**.
4. In the Zone pop-up window, you can set the TV Zone # so that the TV can be configured with Installer Menu and/or TV Setup Menu settings intended only for the assigned Zone. The Installer Menu and/or TV Setup Menu settings may be provided in a TLX file to be used for configuration. If the TV is being configured for FTG Mode, the TV Zone # setting also allows the TV to omit channels that have been restricted in the FTG Channel Map. Use the Left/Right arrow keys to select the TV Zone # (1–8) for this TV. Then, press **OK**.
5. Press **MENU** to return to TV viewing.

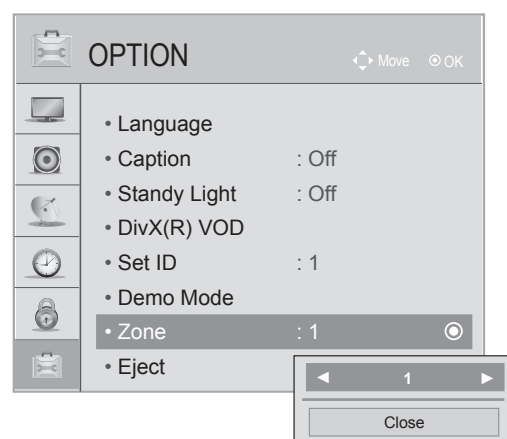

Reference: 22/28LY560M Rear and Side Jack Panels

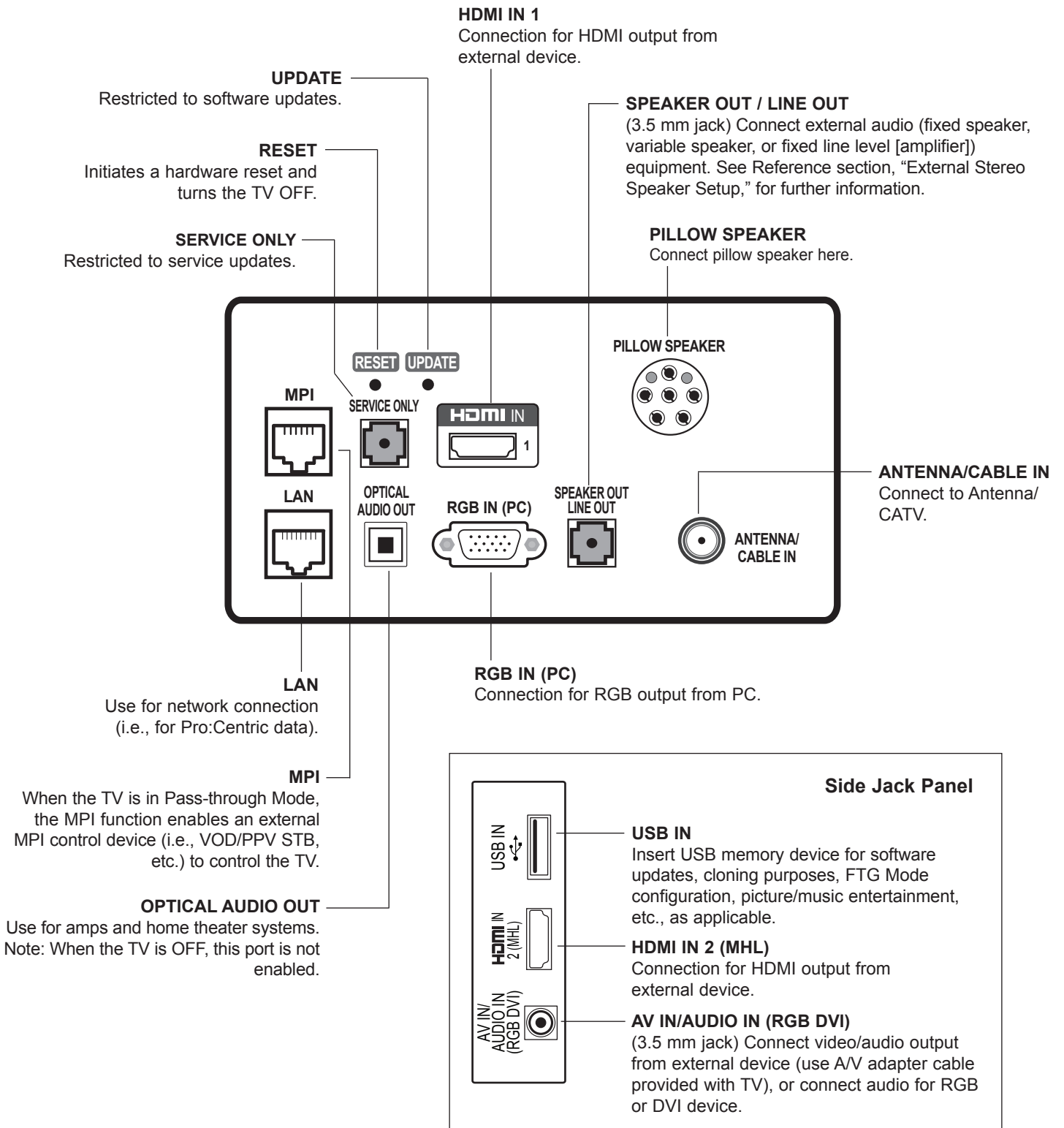

Reference: 32/42LY560M Rear and Side Jack Panels

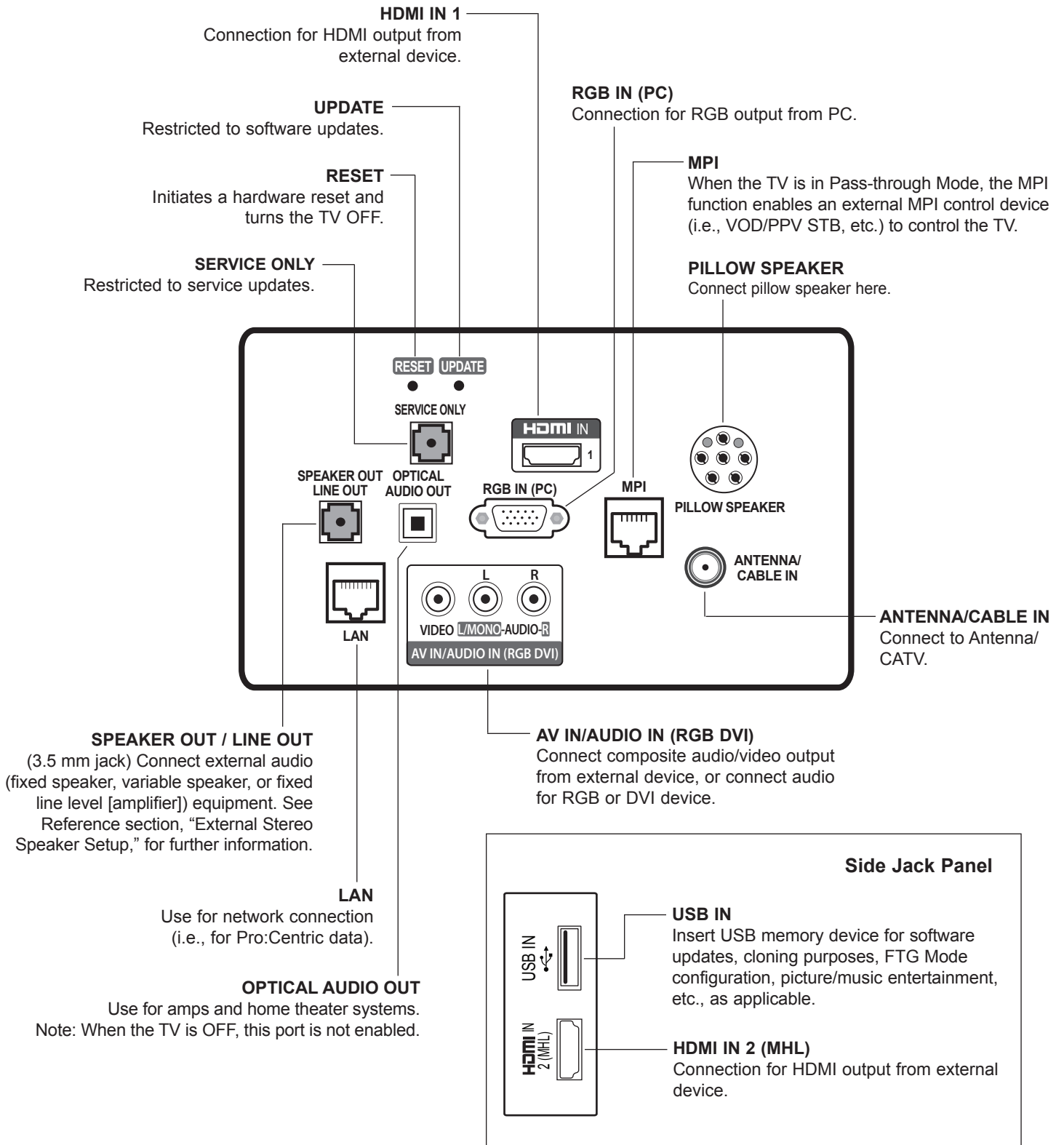

Reference: External Stereo Speaker Setup

The three-contact (left, right, ground) SPEAKER OUT 3.5 mm jack on the LY560M rear panel provides stereo speaker signal outputs (fixed speaker, variable speaker, or fixed line level [amplifier]) for external audio equipment. Set Installer Menu item 097 AUDIO OUTPUT as required in accordance with external audio equipment connected to the TV. Also, refer to the following diagram for pinout details.

 **Caution: Do NOT plug in a mono connector, as this may damage the TV.**

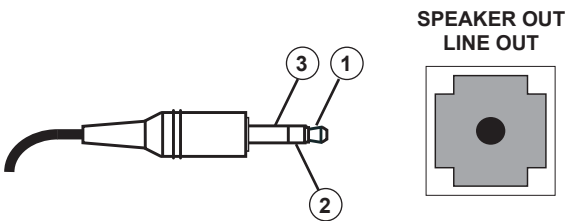

-
- 1 LEFT (Tip)
 - 2 RIGHT (Ring)
 - 3 GROUND (Sleeve)
-

Reference: Installer Remote Control Typical Key Functions

An LG Installer Remote is required to set up and operate the TV. The LG Installer Remote illustrated below shows typical remote control functions and is provided for reference only.

TV LG1/TV LG2 & TV Z1/TV Z2
Selects the IR codes sent by the remote to match the setting in the TV.

NUMBER Buttons (0 - 9) & DASH
Use to enter a channel or program number. Dash is used for sub-channel numbers such as 9-1, 9-2, etc.

FLASHBK (Flashback)
Returns to the previously tuned channel.

CHANNEL UP/DOWN
Changes channels based on channels in the channel lineup.

VOLUME UP/DOWN
Increases/decreases sound level.

Arrows (Up/Down/Left/Right) & OK
Use to navigate on-screen menus, direct tune channels, and adjust TV settings.

CH. BANK
Selects Channel Bank 1, 2, 3, or 4 when Hospital Mode is enabled and the channel lineup resides in the TV's PTC. Otherwise, this button displays available Aux inputs.

CH. PREVIEW
Displays and exits the Channel Preview/Banks Setup Menu.

MUTE
Switches sound On or Off.

TIMER
Sets the amount of time before the TV automatically turns itself Off.

ALARM
Enables users to schedule a one-time "alarm" event, in which the TV turns itself On at the user-specified time.

EXIT
Clears all on-screen displays and returns to TV viewing.

POWER
Turns the TV On or Off.

MENU
Displays and removes the TV setup menus (or, if applicable, the Function Menu).

PORTAL
Displays and removes the Pro:Centric interactive menu.

INFO
Displays channel information.

GUIDE
Displays and removes the Pro:Centric channel guide/EPG.

↵ (RETURN)
Returns one level to the previous menu/display.

Color buttons access special functions in some menus.

CC
Activates subtitles, unless the Channel Preview/Banks Setup Menu is currently on the screen, in which case this option displays the Lock (V-Chip) Menu.

SAP
Analog Mode: Selects MTS sound (Mono, Stereo, or SAP). DTV Mode: Changes the audio language, if additional languages are available.*

* SAP notes:

- SAP settings are retained for individual analog channels when TV is turned Off/On.
- If SAP is selected and no SAP is provided, sound may not be heard on channel.
- Each analog channel may have its own SAP setting.
- Digital channels will reset to default audio language when TV is turned Off/On.

Reference: Pillow Speaker Setup

The pillow speaker will only be functional after the Express Script/Custom Master TV Setup and/or cloning procedures are complete.

Note: When Installer Menu item 027 HOSPITAL MODE is set to 254 (factory default value), there is no power (voltage) supplied to the pillow speaker.

Connecting a Pillow Speaker to the TV

Connect the pillow speaker (see example at right) to the PILLOW SPEAKER interface on the rear jack panel of the TV.

 **Caution:** Use a pillow speaker that is a UL recognized pendant control bearing the warning: “Risk of fire if used in oxygen enriched atmosphere. Keep pendant control away from oxygen equipment.”

Controlling the TV with Serial Data

These TV models are capable of being controlled by a single-wire, serial data signal. This is an LG patented technology and is being implemented by certain brands of “smart” pillow speakers.

Pillow Speaker Interface

This connector provides an interface for patient-pendant remote control or entertainment audio and nurse call systems. All lines are isolated from the AC power line. (Optoisolators isolate the control lines, and a transformer isolates the audio.) Earth ground is provided on pin 4 (Common) in the default configuration (e.g., for Zenith/Philips pillow speakers). For negative voltage configuration (e.g., for RCA pillow speakers), +5 volts is provided on pin 4 (Common), with pin 3 (Channel Up/Data In) referenced to ground.

The following table describes the pillow speaker interface pinout (see also diagram at right).

Pin No.	Description
1	Analog external control for TV ON/OFF.
2	No connection
3	Analog external control for Channel Up or Serial Data In.
4	Common connection for control, data, and audio output.
5	Isolated Audio Output. Nominal 14 ohm source impedance with short circuit protection. Intended for a pillow speaker with a low-impedance, pad-type volume control.
6	Analog external control for Channel Down.

Controlling the TV with Mechanical Switches

A typical analog pillow speaker with mechanical switches will momentarily connect pin 1, 3, or 6 to pin 4 (Common) to control Power ON/OFF, Channel Up, or Channel Down (see schematic at right). These pins are at +13 volts DC (when measured from pin 4) with the switches open. Typical current draw is 8 mA when a switch is closed. (This operation is identical to previous models using the 5-wire interface, except that only +7 volts DC was supplied and current draw was only 2.5 mA.)

Typical Pillow Speaker (Serial Data Control)

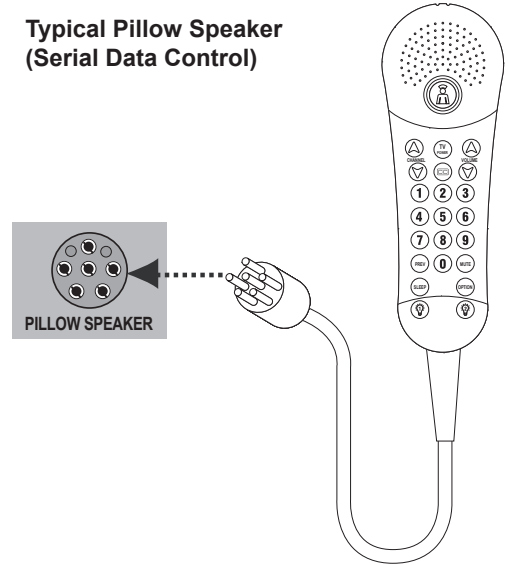

Pillow Speaker Interface Pinout

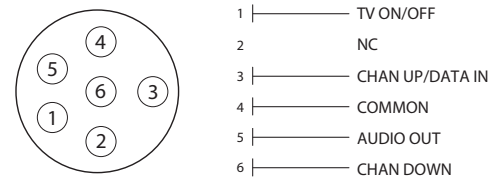

Typical Schematic for Analog Pillow Speaker

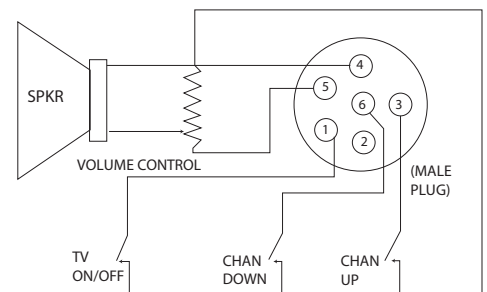

Reference: USB Media Navigation using Pro:Centric Pillow Speaker

The Pro:Centric pillow speaker is currently the only pillow speaker that enables users to navigate and play/view USB media files (videos, music, photos, etc.). This section provides a brief overview of the Pro:Centric pillow speaker navigation tools.

Note: Refer to the Owner's Manual for detailed information on USB memory device requirements and the types of media supported by the LY560M TVs.

1. Insert the USB memory device into the TV's USB port.

Once the TV detects the USB device, the Media Menu will be displayed on the TV screen. (The actual menu header shown on the TV screen will reflect the name of your USB device.)

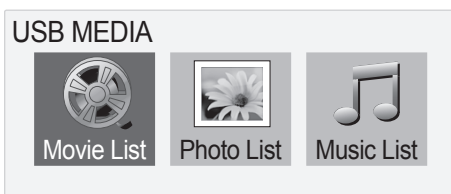

Note: If you press the Return button on the pillow speaker, this will exit the Media Menu. If you wish to redisplay the menu, you must physically remove and then reinsert the USB memory device. It is not possible to display the Media Menu using the pillow speaker alone.

2. Use the arrow keys on the pillow speaker to select/highlight the desired menu option, and then press **Enter**.
 3. Within each USB media directory (Movie List, Photo List, or Music List):
 - Use the arrow keys on the pillow speaker to navigate from one folder or file to another, and press **Enter** to open or play a selected folder or file.
 - If there are multiple pages of folders and/or files, use Channel Up/Down on the pillow speaker to move between the pages. At the top right corner of the display, a "Page" indicator will identify the number of pages available in the current directory.
 - Additional menu options are listed at the bottom of the display (each corresponds to a number button on the pillow speaker). These typically enable you to change directories, change the number of thumbnails shown at one time, mark files (to add to play lists), etc.
- Note:** To exit the Media Menu from any of the three USB media directories, press **0** on the pillow speaker. If you wish to redisplay the Media Menu, you must physically remove and then reinsert the USB memory device.
- In View and Play modes, you typically can use the pillow speaker to navigate to another directory level (without exiting the Media Menu).
 - To exit the directory/Media Menu entirely, either press **0** or **Return** on the pillow speaker.

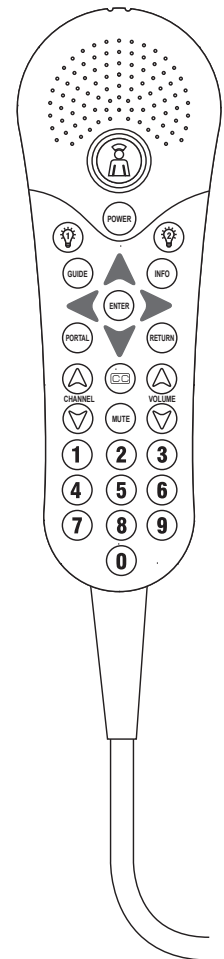

**Typical Pro:Centric
Pillow Speaker**

Reference: VESA Standard TV Mounts

General Guidelines: Choosing a Location for Installing a VESA Standard Mount

To the right are some examples of VESA standard mounts. Since there are numerous types of stands and mounts available, only a few are shown here. Refer to the instructions provided with the TV stand that will be used to mount the TV. Be sure the style of stand selected is capable of supporting the weight of the TV and is appropriate for the application.

Wall Mounts

If the mount will be on a wall, a typical wooden stud behind the wall board would be the preferred choice for a location to attach the wall mount. The wall mount location chosen should be appropriate for drilling holes and have available the required power source as well as antenna/cable and any other equipment leads as necessary.

Pedestal Mounts and Stands

A sturdy surface on a desk or other similar flat table-like furniture would be the appropriate location for mounting a pedestal-style TV stand.

Most stands are designed so that the wiring is threaded through the stand itself or a loop-through style clamp so that the wiring is neatly bunched and not strung in such a way as to create a potential hazard to the user. (Some stands are portable and can be moved from one location to another.) Be sure all safety considerations are followed.

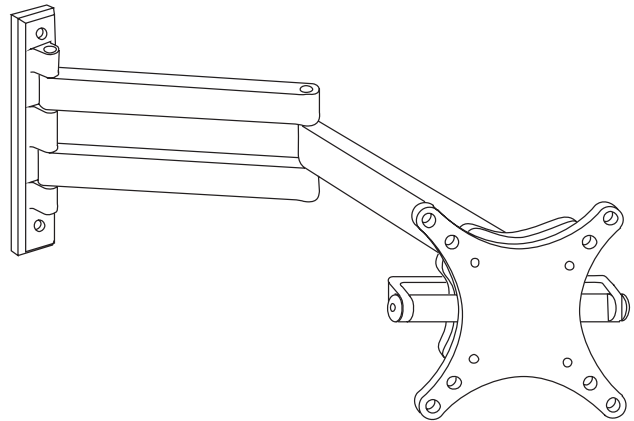

Typical Wall Stud Type Mount with Swivel Bracket

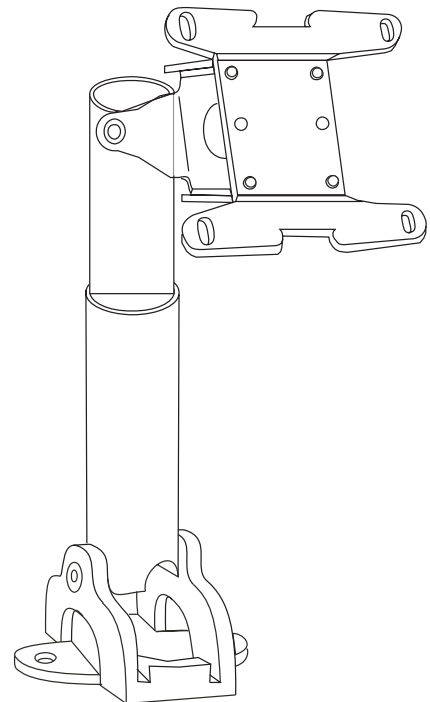

Typical Pedestal Type Mount with Swivel Bracket

General Troubleshooting (Some Quick and Easy Tips for Resolving Problems)

Installation

Symptom	Possible Cause(s)	Possible Solution(s)
Cannot direct enter channel number.	(TV in Pass-through Mode) Installer Menu item 028 CH. OVERRIDE is set to 0, i.e., disabled and/or Channel Access was denied in Express Script.	If the channel lineup is locked (recommended setting), only channels that are active in the TV's channel lineup can be selected. Set 028 CH. OVERRIDE to 1 to allow access for direct keypad entry to all channels.
	(TV in FTG Mode) The channel entered is not included in the FTG Channel Map.	Channel access is restricted to channels included in the FTG Channel Map. If necessary, make changes to the FTG Channel Map using the FTG File Manager.
No channels present after setup.	Auto Tuning (Channel Search) not run.	Refer to Express Script or Custom Master TV Setup procedure, as appropriate. Auto Tuning must be run in order for the channel lineup to be populated. Note for Express Script: You must select "Execute Auto Search" in the Auto Search screen to run search (see page 15). To reactivate the Express Script, perform an "IN-STOP" to restore factory defaults on the TV.

Picture Reception and Sound

Symptom	Possible Cause(s)	Possible Solution(s)
No picture.	TV is turned OFF.	<ul style="list-style-type: none"> • Turn TV ON. • Power failure?
	Antenna/cable not connected.	Connect antenna/cable signal to TV.
	Connections incorrect.	Check connections on TV.
	MPI not connected.	If applicable, connect MPI cable to MPI device.
	Wrong tuning band.	Adjust Installer Menu settings.
Normal picture, poor or no sound.	Broadcast problem.	Try a different channel.
	Audio muted.	Press MUTE or use Volume Up key to increase sound level.
	Pillow/TV speaker not configured properly.	Check that Installer Menu items 020 FEATURE LEVEL and 027 HOSPITAL MODE are set as required. Also, if applicable, select TV Speaker in the Audio Menu.

Erratic Operation

Symptom	Possible Cause(s)	Possible Solution(s)
Installer Menu setup.	Wrong Installer Menu settings.	Adjust Installer Menu settings as required.

Installer Remote

Symptom	Possible Cause(s)	Possible Solution(s)
Remote doesn't work.	Remote not in TV Mode.	Depending on the remote used, you may need to use a MODE key to put the remote into TV Mode.
	Not aimed at IR remote sensor.	Point remote at TV's IR receiver on TV.
	Remote too far from IR sensor.	Move remote closer to TV's IR receiver or darken room.
	MPI not connected.	If applicable, connect MPI cable to MPI device.
	IR path to TV's receiver obstructed.	Remove obstructions.
	Weak batteries.	Replace batteries.
	Wrong battery polarity.	Check that "+" and "-" match in battery compartment.
	Too much light in room.	Dim room light.
Remote IR codes do not match setting(s) in TV.	Make sure the Installer Remote is compatible. Contact your LG dealer, as necessary. Then, check settings both in the TV and on the remote. IR codes sent by the remote must match the setting(s) in the TV.	

Troubleshooting (Cont.)

Commercial Mode Check

Use this flowchart to determine whether the TV is currently in Commercial Mode.

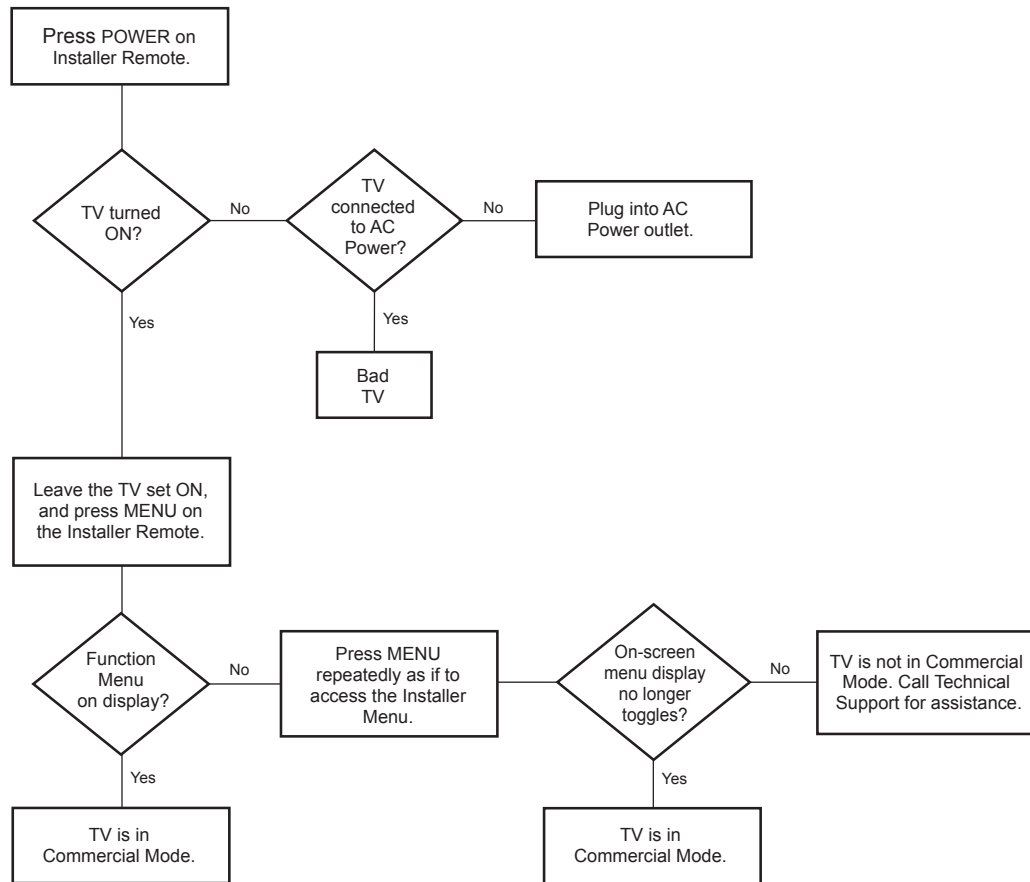

Troubleshooting (Cont.)

Channel Banks Setup Troubleshooting

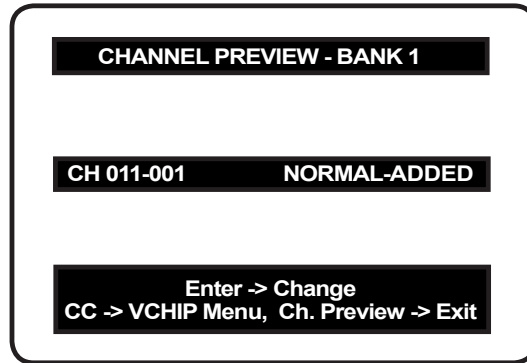

Channel Preview/Banks Setup Menu

Symptom	Possible Cause	Possible Solution
Cannot change channel status in menu.	Channel Access was denied in Express Script and/or Installer Menu item 028 CH. OVERRIDE is set to 0.	Set CH. OVERRIDE to 1 to allow access for channel status change.
Channel Preview/Banks Setup Menu does not appear.	Express Script Installer Menu Wizard/ 2-5-5 + MENU (Custom Master TV Setup) not completed/performed.	The Channel Preview/Banks Setup Menu will not be available until the TV setup is transferred to the PTC. Also, set Installer Menu item 028 CH. OVERRIDE to 1 to allow access for channel status changes.
Channel is blanked in all channel banks.	Blanking a channel in one channel bank will make it blank in all channel banks.	
Cannot tune in deleted channel on Channel Preview/Banks Setup Menu.		Select a channel bank where the deleted channel number is set to NORMAL-ADDED. Direct enter the deleted channel number. Change to the bank in which you want to activate the channel. Select "NORMAL-ADDED" on the Channel Preview/Banks Setup Menu.
"Inactive TV" message appears and then TV turns OFF.	TV is set up to display "Inactive TV" message if all channels are "NORMAL-DELETED" from Channel Bank 4.	Select another channel bank (1, 2, or 3) to return TV to normal operation.
Channel found during Auto Tuning does not tune in with Channel Up/Down.	Channel was deleted in currently selected channel bank.	If banks were set up, premium channels may only be available on another channel bank. Select the channel bank where the channel is set to NORMAL-ADDED. Or, direct enter channel number; then go to Channel Preview/Banks Setup Menu and select "NORMAL-ADDED."
When BANK on Installer Remote is pressed, TV shows Input List Menu.	Installer Menu item 027 HOSPITAL MODE is set to 0.	Set item 027 to appropriate setting for channel banks to appear with BANK key presses.

Glossary of Terms

Channel Lineup

Channels set in the TV memory, via Auto Tuning/manual editing.

Channel Banks

Enables tiered channel programming options for hospital models. Each channel bank may offer a custom channel lineup.

Cloning

The process of capturing a Master TV Setup and transferring it to a Target TV using a USB memory device.

Commercial Mode

A mode of operation that provides a broad range of commercial TV features based on control (settings) provided by the PTC and/or an MPI control device.

CPU

The TV's Central Processing Unit. Responsible for the presentation of video and audio from content received via the TV's tuner or Aux inputs.

Express Script Installer Menu Wizard

Hospital model TV configuration wizard that guides the installer through the process of setting up essential hospital model features for a typical viewing application.

E-Z Installation

Enables splash screen image and TV configuration and firmware file downloads to selected TV models from a Pro:Centric server. Managed and administered via the Pro:Centric Admin Client.

FTG Channel Map

Typically refers to a logical channel mapping of physical RF channels. This allows digital channels, like analog channels, to be tuned without requiring the dash key. Also, channels (analog or digital) can be arranged in any order that seems logical for customer tuning/viewing.

FTG Mode

LG commercial TV mode that enables decryption of Pro:Idiom encrypted channels and uses logical channel mapping. LG's proprietary PC software is required for configuration.

Function Menu

Available via Installer Remote "MENU" key. Indicates the TV is not in Pass-through Mode. Restricts menu options to a subset of the TV setup menus, allowing users to retain functional control, while disabling setup options.

Installer Menu

Defines commercial TV functionality based on the parameters set.

LG Free-To-Guest (FTG)

Refers to a particular commercial mode of operation within an LG TV. See also FTG Mode.

Logical Channel Number

A number assigned to either a physical or virtual channel number in a Logical Channel Map.

Major Channel Number

Typically, the RF channel number assigned to a digital video stream.

Master TV

A TV whose Channel Map and Installer Menu and TV setup menu settings have been configured as a Master TV Setup for cloning purposes.

Minor Channel Number

A sub-channel or program number assigned to the content embedded in the digital video stream.

MPI

Multiple Protocol Interface. An MPI port or, for some TV models, an MPI card slot provides external control options for solution providers.

Pass-through Mode

The TV's factory default mode of operation. TVs can be configured for stand-alone use or as Master TVs for cloning purposes, and/or TVs may be controlled externally in this mode.

Physical Channel Number

The major channel number assigned to represent a specific 6 MHz RF band as specified by either the broadcast or CATV channel plan. See CEA (formerly EIA) or NCTA specifications for further information.

Pillow Speaker

A wired remote control for patient in-room hospital model TVs. The pillow speaker also may be connected through a nurse call system providing two way communication between the patient and the nurses' station. TV audio can be configured to originate from the pillow speaker or the TV main speakers or both.

Pro:Centric Application

LG content delivery and communication interface that provides interactive entertainment, weather, amenities, etc. information for end users. (Powered by Pro:Centric server.)

Pro:Centric Admin Client

Web editor/content wizard provided for service provider and customer configuration of Pro:Centric application elements.

Pro:Idiom

Zenith proprietary security software that unlocks access to premium content to help assure rapid, broad deployment of HDTV and other high-value digital content.

PTC

Protocol Translator Card. The commercial controller (microprocessor) of the commercial TV.

Target TV

A TV to which a Master TV Setup will be transferred.

TV Setup Menus

Available via Installer Remote "MENU" key in Pass-through Mode only. Menus provide access to setup and functional features of the TV.

USB Memory Device

A USB flash drive or USB storage device, etc. that can be used for TV configuration purposes (typically cloning or FTG Mode via CPU configuration) or for updating TV software.

Virtual Channel Number

An alias (virtual) channel number provided in the data stream, by the broadcaster, of a digital broadcast channel to be displayed by consumer TVs in place of the physical channel number. The major number is the same as the original analog channel number and the minor number is the nth program available in that digital video stream.

Document Revision History / Open Source Software Notice

Document Revision History

Date	Description
June 2014	Revision A: New document

Product documentation is available online at: www.LGolutions.com.

Open Source Software Notice

To obtain the source code under GPL, LGPL, MPL and other open source licenses, that is contained in this product, please visit <http://opensource.lge.com>. In addition to the source code, all referenced license terms, warranty disclaimers and copyright notices are available for download. LG Electronics will also provide open source code to you on CD-ROM for a charge covering the cost of performing such distribution (such as the cost of media, shipping and handling) upon e-mail request to opensource@lge.com. This offer is valid for three (3) years from the date on which you purchased the product.



For Customer Support/Service, please call:

1-888-865-3026

www.LGsolutions.com

Pro:Idiom is a registered trademark of Zenith Electronics LLC. Pro:Centric is a registered trademark of LG Electronics Inc. All other trademarks or registered trademarks are the property of their respective owners.

Free Manuals Download Website

<http://myh66.com>

<http://usermanuals.us>

<http://www.somanuals.com>

<http://www.4manuals.cc>

<http://www.manual-lib.com>

<http://www.404manual.com>

<http://www.luxmanual.com>

<http://aubethermostatmanual.com>

Golf course search by state

<http://golfingnear.com>

Email search by domain

<http://emailbydomain.com>

Auto manuals search

<http://auto.somanuals.com>

TV manuals search

<http://tv.somanuals.com>