



**32LH250H 37LH250H 42LH250H
32LH255H 37LH255H 42LH255H
37LH260H 42LH260H
37LH265H**

Lodging Guest Interactive TVs

Commercial Mode Setup Guide

Note: Selected features shown within this guide may not be available on all models.

EXPERIENCED INSTALLER

Commercial Mode Setup
page 7

b-LAN™ Setup & Overview
page 42

Cloning Information
pages 20–23

For Customer Support/Service, please call:

1-888-865-3026

The latest product information and documentation is available online at:

www.LGcommercial.com/products

MODEL and SERIAL NUMBER

The model and serial numbers of this TV are located on the back of the cabinet. For future reference, LG suggests that you record those numbers here:

Model No. _____ Serial No. _____



WARNING
RISK OF ELECTRIC SHOCK
DO NOT OPEN



WARNING:

TO REDUCE THE RISK OF ELECTRIC SHOCK DO NOT REMOVE COVER (OR BACK). NO USER-SERVICEABLE PARTS INSIDE. REFER TO QUALIFIED SERVICE PERSONNEL.



The lightning flash with arrowhead symbol, within an equilateral triangle, is intended to alert the user to the presence of uninsulated “dangerous voltage” within the product’s enclosure that may be of sufficient magnitude to constitute a risk of electric shock to persons.



The exclamation point within an equilateral triangle is intended to alert the user to the presence of important operating and maintenance (servicing) instructions in the literature accompanying the appliance.

WARNING:

TO PREVENT FIRE OR SHOCK HAZARDS, DO NOT EXPOSE THIS PRODUCT TO RAIN OR MOISTURE.

POWER CORD POLARIZATION:

This product is equipped with a 3-wire grounding-type alternating current power plug. This plug will fit into the power outlet only one way. This is a safety feature. If you are unable to insert the plug fully into the outlet, contact your electrician to replace your obsolete outlet. Do not defeat the safety purpose of the 3-wire grounding-type plug.

NOTE TO CABLE/TV INSTALLER:

This reminder is provided to call the cable TV system installer’s attention to Article 820-40 of the National Electric Code (U.S.A.). The code provides guidelines for proper grounding and, in particular, specifies that the cable ground shall be connected to the grounding system of the building, as close to the point of the cable entry as practical.

REGULATORY INFORMATION:

This equipment has been tested and found to comply with the limits for a Class B digital device, pursuant to Part 15 of the FCC Rules. These limits are designed to provide reasonable protection against harmful interference when the equipment is operated in a residential installation. This equipment generates, uses and can radiate radio frequency energy and, if not installed and used in accordance with the instruction manual, may cause harmful interference to radio communications. However, there is no guarantee that interference will not occur in a particular installation. If this equipment does cause harmful interference to radio or television reception, which can be determined by turning the equipment off and on, the user is encouraged to try to correct the interference by one or more of the following measures:

- Reorient or relocate the receiving antenna.
- Increase the separation between the equipment and receiver.
- Connect the equipment to an outlet on a circuit different from that to which the receiver is connected.
- Consult the dealer or an experienced radio/TV technician for help.

CAUTION:

Do not attempt to modify this product in any way without written authorization from LG Electronics U.S.A., Inc. Unauthorized modification could void the user’s authority to operate this product.

COMPLIANCE:

The responsible party for this product’s compliance is: LG Electronics U.S.A., Inc.
1000 Sylvan Avenue, Englewood Cliffs, NJ 07632, USA • Phone: 1-201-816-2000

Marketed and Distributed in the United States by LG Electronics U.S.A., Inc.
1000 Sylvan Avenue, Englewood Cliffs, NJ 07632

IMPORTANT SAFETY INSTRUCTIONS

Important safeguards for you and your new product

THIS PRODUCT HAS BEEN MANUFACTURED AND TESTED WITH SAFETY IN MIND. IMPROPER USE, HOWEVER, CAN RESULT IN POTENTIAL ELECTRICAL SHOCK OR FIRE HAZARDS. TO AVOID DEFEATING THE SAFEGUARDS THAT HAVE BEEN BUILT INTO THIS PRODUCT, PLEASE READ AND OBSERVE THE FOLLOWING SAFETY POINTS WHEN INSTALLING AND USING THIS PRODUCT.

- 1. Read these instructions.**
Read all safety and operating instructions before operating the product.
- 2. Keep these instructions.**
Retain the safety and operating instructions for future reference.
- 3. Heed all warnings.**
Adhere to all warnings on the product and in the operating instructions.
- 4. Follow all instructions.**
Follow all operating and use instructions.
- 5. Do not use this apparatus near water.**
Do not use this product near water or moisture or in an area, such as a basement, that might become flooded.
- 6. Clean only with dry cloth.**
Unplug this product before cleaning. When cleaning, scrub gently with a soft cloth to prevent scratching. Do not spray water or other liquids directly on the product as electric shock may occur. Do not clean with chemicals such as alcohol, thinners, or benzene.
- 7. Do not block any ventilation openings. Install in accordance with the manufacturer's instructions.**
Install where there is proper ventilation. Do not install in a confined space such as a bookcase. Do not cover the product with cloth or other materials (e.g., plastic) while it is plugged in. Do not install in excessively dusty places. Do not touch ventilation openings, as they may become hot while the product is operating.
- 8. Do not install near any heat sources, such as radiators, heat registers, stoves, or other apparatus (including amplifiers) that produce heat.**
- 9. Do not defeat the safety purpose of the polarized or grounding-type plug. A polarized plug has two blades with one wider than the other. A grounding-type plug has two blades and a third grounding prong. The wide blade or the third prong are provided for your safety. If the provided plug does not fit into your outlet, consult an electrician for replacement of the obsolete outlet.**
- 10. Protect the power cord from being walked on or pinched, particularly at plugs, convenience receptacles, and the point where it exits from the apparatus.**
- 11. Only use attachments/accessories specified by the manufacturer.**
- 12. Use only with the cart, stand, tripod, bracket, or table specified by the manufacturer or sold with**

the apparatus. When a cart is used, use caution when moving the cart/apparatus combination in order to avoid injury from tip-over.



- 13. Unplug this product during lightning storms or when unused for long periods of time.**
Also, disconnect the antenna or cable system to prevent damage to the product due to lightning and power-line surges. Never touch this apparatus or antenna during a thunder or lightning storm.
- 14. Refer all servicing to qualified service personnel. Servicing is required when the apparatus has been damaged in any way, such as power-supply cord or plug is damaged, liquid has been spilled or objects have fallen into the apparatus, the apparatus has been exposed to rain or moisture, does not operate normally, or has been dropped.**
- 15. Wall or Ceiling Mounting**
This product should be mounted to a wall or ceiling only as recommended by the manufacturer. When mounting a TV, make sure not to install the TV by the hanging power and signal cables on the back of the TV.
- 16. Transporting Product**
Make sure the product is turned off and unplugged and that all cables have been removed. It may take two or more people to carry larger TVs. Do not press against or put stress on the front panel of the TV.
- 17. Disconnect Device**
The main plug is used as the disconnect device. The disconnect device must remain readily operable. Be sure to grasp the plug when unplugging the power cord. Do not pull on the power cord to unplug the TV.
- 18. Object and Liquid Impact/Entry**
Do not allow an impact shock or any objects to fall into the product, and do not drop items onto the screen. Do not press strongly on the panel with a hand or sharp object, and never push objects of any kind into the panel or through openings as they may damage the product and/or touch dangerous voltage points or short-out parts that could result in a fire or electric shock. Never spill liquid of any kind on the product.

(Continued on next page)

IMPORTANT SAFETY INSTRUCTIONS

(Continued from previous page)

19. Power Sources

This product should be operated only from the type of power source indicated on the marking label. If you are not sure of the type of power supply to your installation, consult your product dealer or local power company.

20. Overloading

Do not overload wall outlets and extension cords as this can result in a risk of fire or electric shock. It is recommended that appliances be placed upon a dedicated circuit; that is, a single outlet circuit which powers only that appliance and has no additional outlets or branch circuits. Overloaded wall outlets, loose or damaged wall outlets, extension cords, frayed power cords, or damaged or cracked wire insulation are dangerous. Any of these conditions could result in fire or electric shock.

21. Power Cord

Periodically examine the cord of your appliance, and if its appearance indicates damage or deterioration, unplug it, discontinue use of the appliance, and have the cord replaced with an exact replacement part by an authorized servicer. Protect the power cord from physical or mechanical abuse, such as twisting, kinking, or pinching.

22. Outdoor Use/Wet Location



Warning: To prevent fire or electrical shock hazards, do not expose this product to rain, moisture, or other liquids.

Do not touch the product with wet hands. Do not install this product near flammable objects such as gasoline or candles or expose it to direct air conditioning. Do not expose the product to dripping or splashing, and do not place objects filled with liquids, such as vases, on or over the apparatus (e.g., on shelves above the unit).

23. Grounding

Ensure that you connect the earth ground wire to prevent possible electric shock (i.e., a TV with a three-prong grounded AC plug must be connected to a three-prong grounded AC outlet). If grounding methods are not possible, have a qualified electrician install a separate circuit breaker. Do not try to ground the unit by connecting it to telephone wires, lightning rods, or gas pipes.

24. Outdoor Antenna Grounding

If an outside antenna or cable system is connected to the product, follow the precautions below.

An outdoor antenna system should not be located in the vicinity of overhead power lines or other electric light or power circuits or where it can come into contact with such power lines or circuits as death or serious injury can occur.

Be sure the antenna or cable system is grounded so as to provide some protection against voltage surges and built-up static charges.

Article 810 of the National Electrical Code (NEC) (in the U.S.A.) provides information with regard to proper grounding of the mast and supporting structure, grounding of the lead-in wire to an antenna-discharge unit, size of grounding conductors, location of antenna-discharge unit, connection to grounding electrodes, and requirements for the grounding electrode.

Antenna Grounding According to NEC, ANSI/NFPA 70

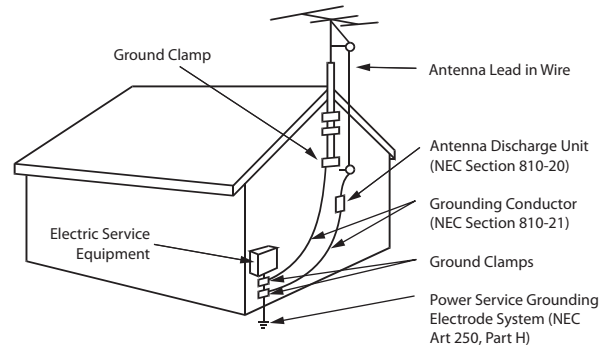

25. Damage Requiring Service

Unplug this product from the wall outlet and refer servicing to qualified service personnel under the following conditions:

- If the power-supply cord or plug is damaged.
- If liquid has been spilled, or objects have fallen into the product.
- If the product has been exposed to rain or water.
- If the product does not operate normally per the operating instructions. Adjust only those controls that are covered by the operating instructions, as an improper adjustment of other controls may result in damage and will often require extensive work by a qualified technician to restore the product to its normal operation.
- If the product has been dropped, or the cabinet has been damaged.
- If the product exhibits a distinct change in performance.
- If you smell smoke or other odors coming from the product or hear strange sounds.

26. Replacement Parts

When replacement parts are required, be sure the service technician uses replacement parts specified by the manufacturer or that have the same characteristics as the original part. Unauthorized substitutions may result in fire, electric shock, or other hazards.

27. Safety Check

Upon completion of any service or repairs to this product, ask the service technician to perform safety checks to determine that the product is in proper operating condition.

28. Sunlight

Keep the product away from direct sunlight.

Table of Contents

Safety Warnings	2	References	
Important Safety Instructions	3–4	Detailed Instructions for Making a Master TV	30
Table of Contents	5	Adding Channel Icons / Custom Channel Labels (2-5-4 + MENU Mode)	31
Setup Checklist	6	Clonable Menu Features / Checking Software Version	32
Commercial Mode Setup for Master TV	7	USB End User Features	33
Installer Overview	8	USB Cloning / Master TV Profile Setup-Learning	34
Embedded <i>b</i> -LAN™ Module (EBL) FTG Mode of Operation Overview	9–10	USB Cloning / Master TV Profile Setup-Teaching	35
FTG Channel Map Overview	11	TV Campport Auto Sense Operation	36
FTG Installer Menu Overview	12	TV Aux Input Configuration	37
FTG Operation Troubleshooting	13	General Troubleshooting	38
Typical Installer Remote Control	14	LT2002 Cloning Procedure Troubleshooting	39
Installer Remote Control Key Functions	15	Troubleshooting Flow Chart	40
Rear Connections Panel	16	Commercial Mode Check	41
Side Connections Panel / RF Antenna Connection	17	<i>b</i> -LAN Setup & Overview	42
RJP / TV Connections & Setup	18	RJP Model List and Input Auto-sensing Hierarchy	43
TV Features Configuration Menus Overview	19	Glossary of Terms	44
TLL-1100A Cloning Connections / Learning Setup	20		
LT2002 Cloning Connections / Learning Setup	21–22	Document Revision History / Notes	45
LT2002 Cloning Connections / Teaching Setup	23	Back Cover	46
Installer Menu	24–29		

Notes

- This document does not include Commercial Mode Setup information for LH240H TVs. Refer to the **Commercial Mode Setup Guide** for LH240H TVs for further information.
- Go to page 7 to begin the Commercial Mode Master TV setup.
- Refer to the “Installer Menu” section of this document to set up the operational features of the TV. Installer Menu content is intended for use primarily by qualified TV electronics technicians.
- This document references Installer Remote Controls used for menu operation. The remote information is provided for reference only. The typical Installer Remote Control shown for reference in this document may be different from the actual remote control supplied with the TV.
- For additional information, contact your LG representative.

Note: Design and specifications are subject to change without prior notice.

Setup Checklist

Installation and Setup Checklist

- Unpack TV and all accessories.
 - Install batteries in remote control.
 - Install TV on VESA mount or stand.
- Note:** It may be advisable to make all hardware connections before installing on VESA mount or stand, as appropriate.

Hardware Connections

- Install any additional hardware as appropriate to your institution, LAN, etc.

Hardware Connections

- Make all connections to rear Jack Pack and RF antenna on MPI card.
- Make all connections to signal, interactive resources, and Aux sources, as appropriate.

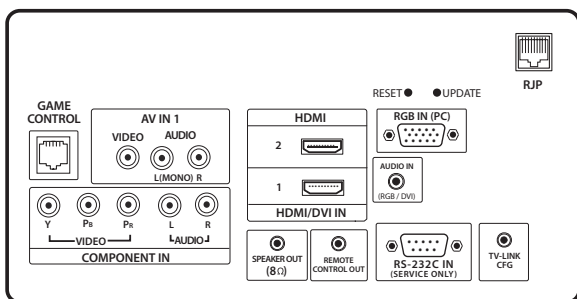

Installer Menu Items Setup

- Configure all relevant Installer Menu items as required of your institution.

TV Menus Configuration

Configure TV features for the end user.

- Channel
- Picture
- Audio
- Option
- Time
- Lock
- Choose on-screen menu language. (English is the default language.)

Commercial Mode Setup

- Complete Commercial Mode Setup (see next page).

Software Installation

- Install or configure any software, as applicable, for example, Pay-Per-View (PPV), etc.

Additional Features Setup

- Select viewing source on TV. (See also Table of Contents.)

Commercial Mode Setup for Master TV

This page provides an overview of a Master TV configuration.

Note: Disconnect all Aux inputs. Under certain conditions, Auto Tuning (Channel Search) is disabled if there is an Aux input active.

Commercial Mode Setup Procedure

1. Set Installer Menu Items

(Enter the TV Installer Menu—refer to the “Installer Menu” section of this document for detailed instructions.)

- a. Set Installer Menu item **117 FACT DEFAULT** to **001**, and press **ENTER** on the Installer Remote. (This clears all Installer Menu custom settings, channel labels / icons, etc. and reloads the factory default settings.)
- b. Set item **003 BAND/AFC**, as appropriate.
 - **Broadcast:** Set to **000**. - **HRC:** Set to **002**.
 - **CATV:** Set to **001**. - **IRC:** Set to **003**.
- c. Set other particular installer items that affect your TV programming network. Enable/disable Aux sources, set a Start Channel, etc.
- d. After you have adjusted all required Installer Menu item settings, press **ENTER** on the remote to exit the menu and save your changes.

2. Set Up TV Features

(Channel, Picture, Audio, Lock, Time, Option, Digital Captions, etc. See TV Clonable Options list and TV Menus information.)

3. Run Auto Tuning (Channel Search)

- a. (Search for all available channels.) Go to the Channel Menu, access the Auto Tuning option, and follow the on-screen instructions.
- b. Edit the Channel Scan. In the Channel Menu, access the Channel Edit option.
 - Add/delete channels per your system requirements.
Note: Physical channel numbers are used to identify virtual channels.
 - Add familiar channel trademarks/logos like ABC, CBS, NBC, etc. to the Channel-Time on-screen display. In the Channel Menu, select the Channel Label option. Add identifiable labels (logos) for the end user to readily know what common networks are available.

4. Transfer TV Setup to Internal TV Controller: 2-5-5 + MENU Mode

After the TV channel scan has been edited and channel label icons added, enter the Installer Menu. Once in the Installer Menu, press **2-5-5 + MENU** on the remote. This transfers the TV setup to the internal controller box.

5. Add Custom Channel Labels for Analog Channels: 2-5-4 + MENU Mode

Enter the Installer Menu, and press **2-5-4 + MENU**. Add your own custom text labels to channel on-screen displays. **Note:** Digital Channels often have a broadcaster generated label (see 2-5-4 + MENU reference information). When you are finished, press **MENU** to exit 2-5-4 + MENU Mode.

Verify TV Setup

At this point, verify that the channel lineup, channel icons, and custom labels are correct. Make sure the TV features are set per your requirements. Set item **028 CH. OVERRIDE** to **000** to lock the channel scan and restrict Setup Menu access. After the preceding has been completed, the Master TV Setup is ready to be copied to a Clone Programmer (see cloning information in this document).

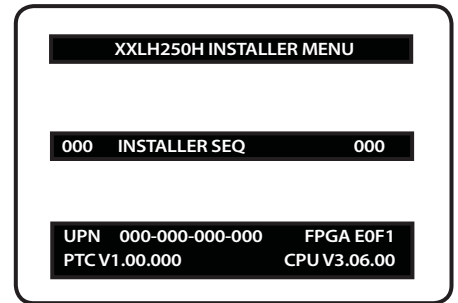

Typical TV Installer Menu

Note: The Installer Menu header will vary depending on the TV you are setting up.

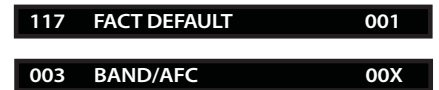

Adjust the settings for these Installer Menu items.

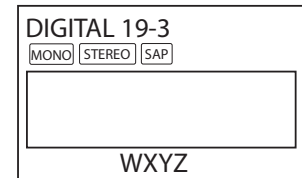

Custom Text Label “WXYZ” created in 2-5-4 + MENU (Add Channel Label) Mode.



Set 093 RJP Available to 001 if using a Remote Jack Pack.



After Master TV Setup is completed, set item 028 CH. OVERRIDE to 000.

Installer Overview

This is the Commercial Mode Setup guide only.

Operating Installer Menu

To set up the controls for the TV, you will need to know how to enter the TV Installer Menu and make changes to the default values as required. If necessary, familiarize yourself with the TV Installer Menu and how to make and save changes in the menu.

LG Installer Remote Control

You will need an LG Installer Remote similar to the one shown to the right. The Installer Remote must have a SOURCE button or its equivalent. The remote shown in this manual has an INPUT button, which serves the purpose of a SOURCE button.

The TV's clonable features need to be set up. This is a critical step. If the Master TV display panel's clonable features, such as adding channel icons or channel labels, are not done correctly, the cloned TVs will all have problems. Refer to the Owner's Manual for information on other TV features: Video, Audio, Closed Captions, V-Chip, etc.

TLL-1100A Clone Programmer

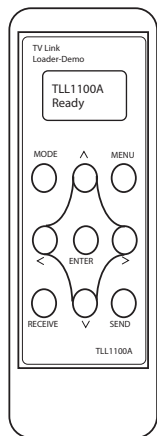

The TLL is a very simple cloner to use. It can be set up to clone a Master TV Setup and transfer it into a Target TV. Cloning is accomplished using the TV/cloner MPI ports for communication. Ensure the Master TV is set up completely. Cloning is only possible when the TV is tuned to an Aux source or an analog channel (not a digital channel).

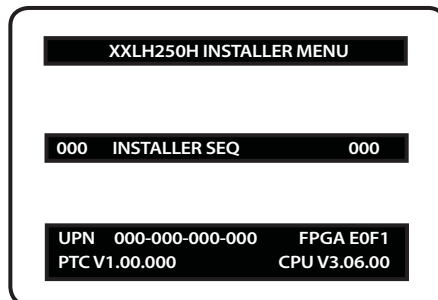

Typical Installer Menu

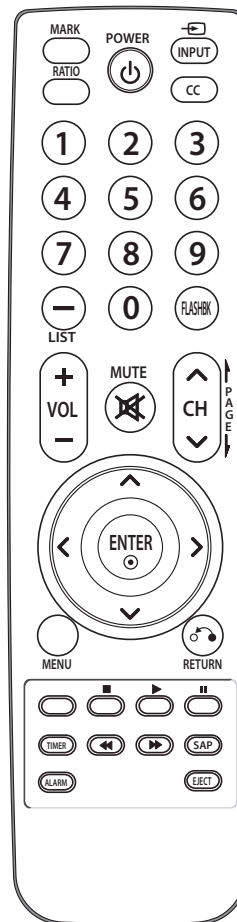

Embedded *b*-LAN™ Module (EBL) FTG Mode of Operation Overview

The following steps outline the FTG (Free-To-Guest) setup for individual TV control.

1. Set up commercial features of the TV. Enter the Installer Menu, and set all desired items as required (for example, Tuning Band, Start Channel, etc.). Refer to the “Installer Menu” section of this document for further information.
2. Install the FTG Configuration Application program on the PC that will be used to configure the EBL.
3. Connect the PC to the TV-LINK CFG jack on the rear panel using a USB-to-TTL serial cable (TTL-232R-5V-AJ).
4. Launch the FTG Configuration Application, and create a new or open an existing FTG Configuration file.
5. Build a Channel Map and “write” it to the EBL (converts EBL from Pass-Through Mode to FTG Mode).
6. If necessary, make changes to Installer Menu items using the FTG Installer Menu Configuration Utility and “write” the changes to the EBL in FTG Mode.
7. Save the FTG Configuration (.rml) file for future use.
8. Tune the TV to a Logical Channel in the Channel Map.

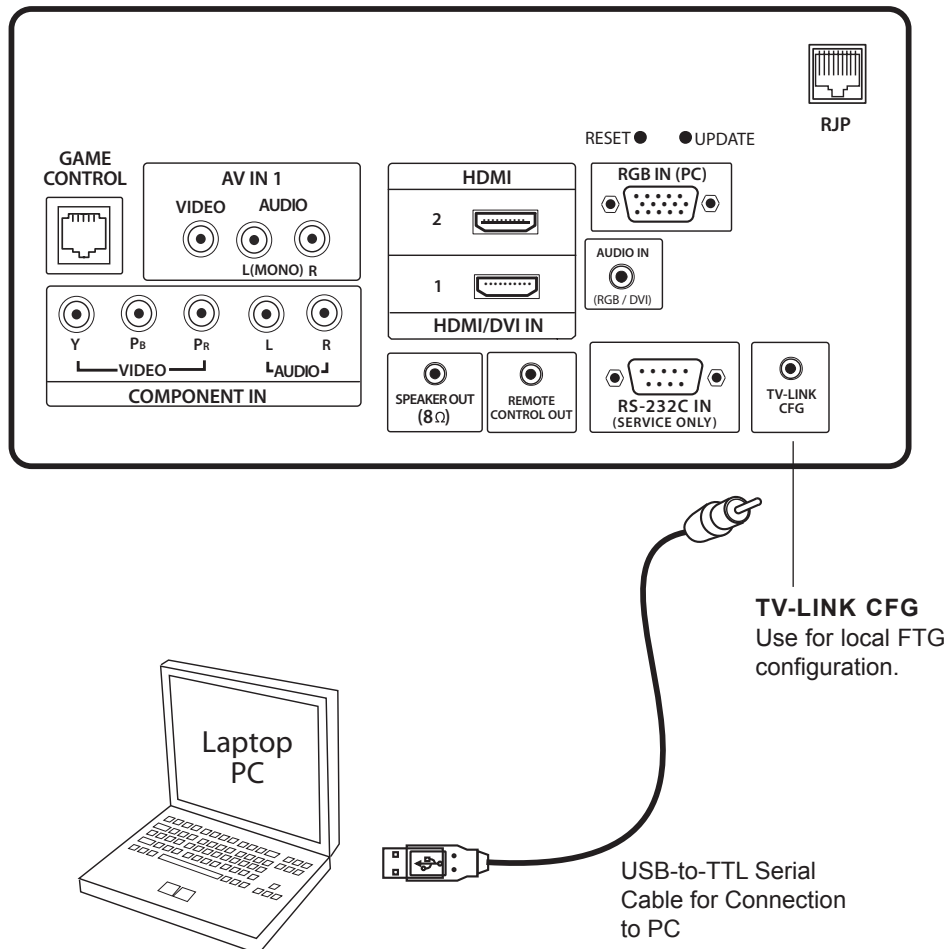

Embedded *b*-LAN™ Module (EBL) FTG Mode of Operation Overview (Cont.)

To determine the operating mode of the TV, press **MENU**. If the Setup or TV Menu appears, the EBL is in Pass-Through Mode. If the End User “Aspect Ratio” or “Function” menu appears, the TV is in FTG Mode.

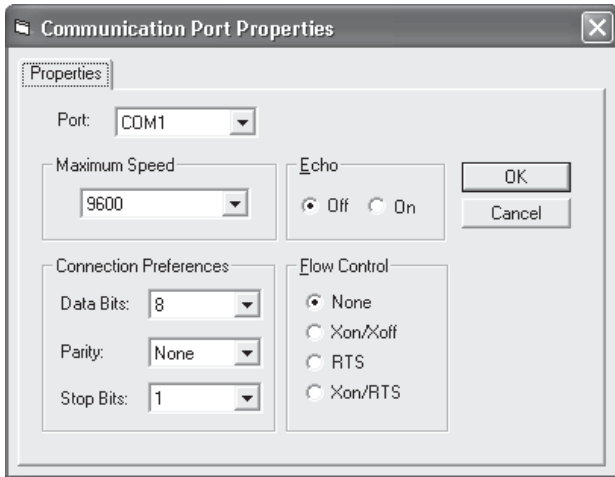

Communications Setup Menu

Sets up the communications link between the FTG Configuration Application and the EBL in a TV.

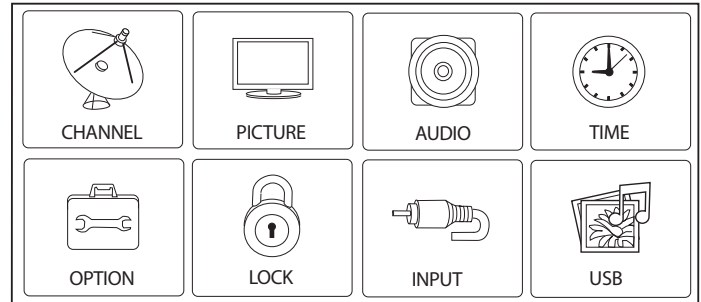

Typical TV Setup Menu

Shows that the EBL is in Pass-Through Mode. You can also access this menu by turning IR Remote Access ON in the FTG Configuration Application, while the TV is in FTG Mode.

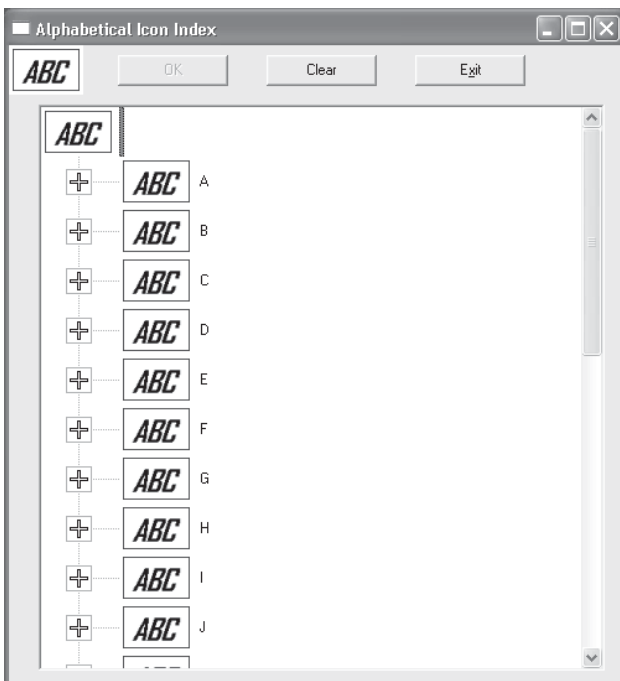

Network Icon Selection Menu

Select channel icons, such as ABC, NBC etc., to add to the channel OSDs to identify common networks for the end user.

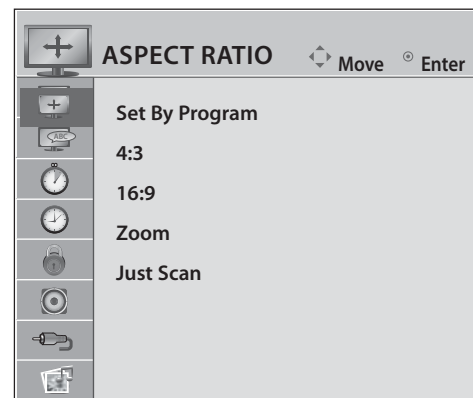

End User “Aspect Ratio” or “Function” Menu

Shows that the EBL is in FTG Mode. While this menu is present on-screen, the only way the Installer Menu can be accessed is via the FTG Configuration Application.

FTG Channel Map Overview

Writing a Channel Map into EBL will switch the EBL from Pass-Through Mode to FTG Mode. When the Aspect Ratio/Function menu is present, EBL is in FTG Mode.

LOGICAL CHANNEL NUMBERS

Channels appear in numerical order. Select Logical, Major, and Minor numbers on menu.

CUSTOM CHANNEL LABELS/ICONS

Set custom labels and select icons on menu.

SET CHANNEL ATTRIBUTES

Set Encrypted and OSD on or off or Blank Video only.

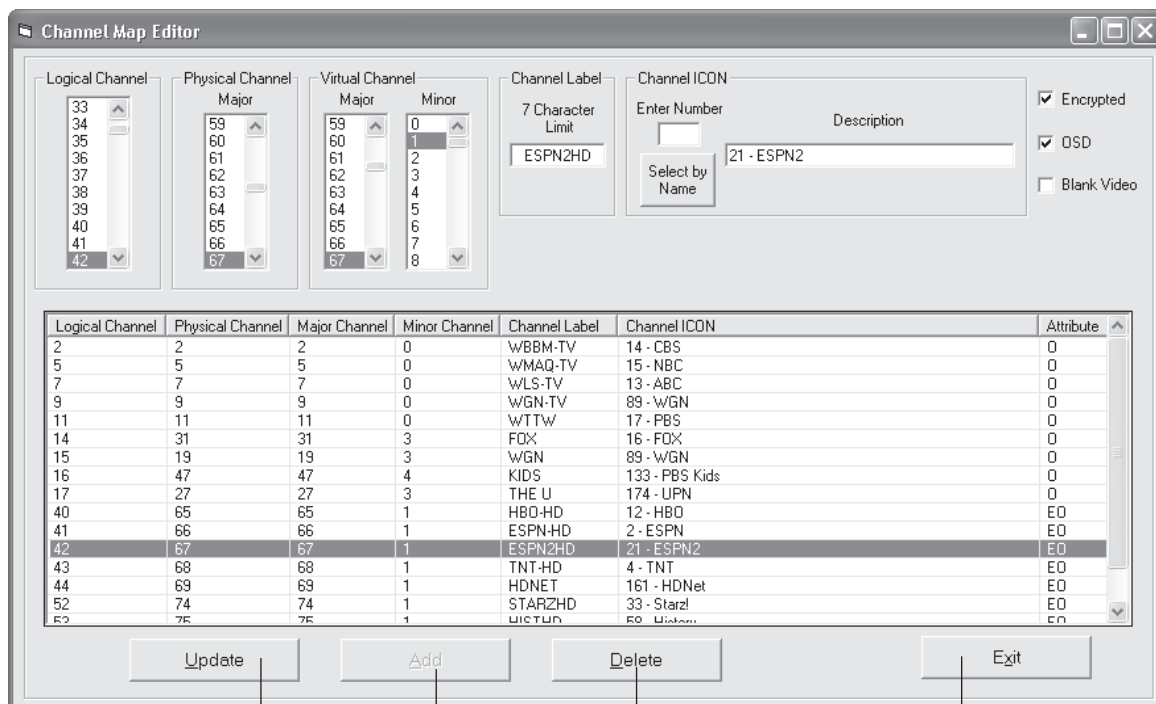

CHANNEL MAP EDITOR

Shows both Channel Data and Logical Channel Lineup.

EXIT

Exits menu and returns to Logical Channel listing.

DELETE

Removes channel from lineup.

ADD

After inputting a new channel's data, press to add channel to list.

UPDATE

After editing a channel's data, press to include the changes in the Channel List.

FTG Installer Menu Overview

CONFIGURATION SETTINGS

Select tabs for categories of Installer Menu items to set up TV.

HOSPITAL-GRADE TV ONLY

Set Hospital items on Installer Menu for hospital-grade TVs.

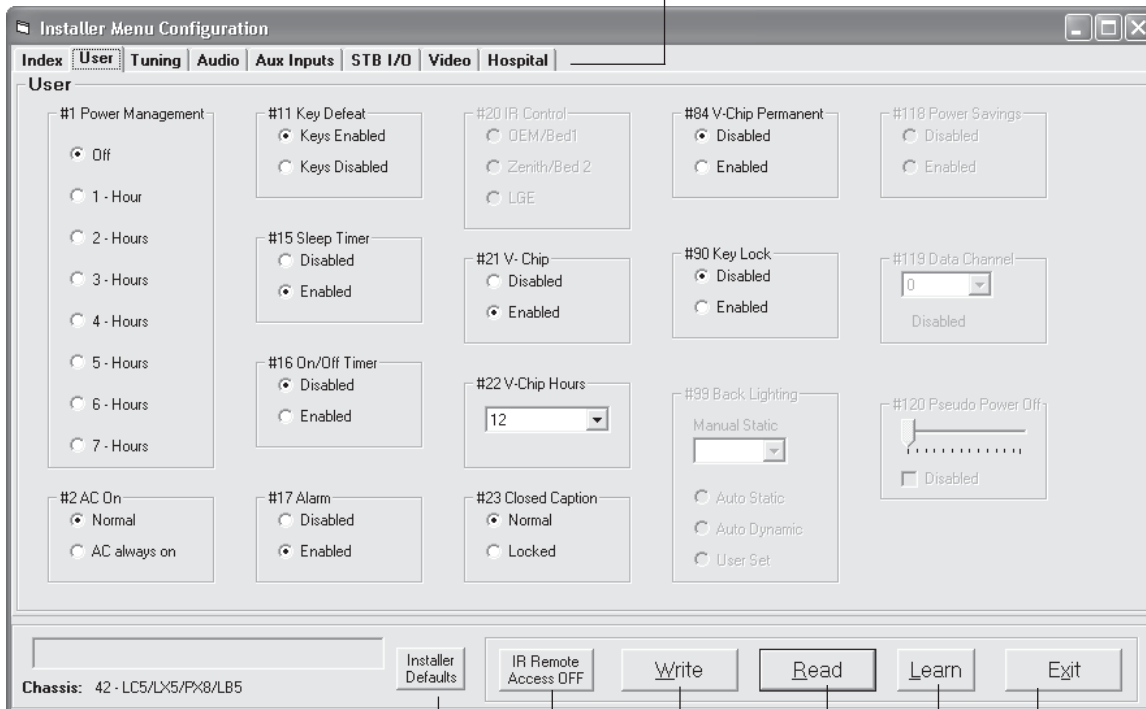

INSTALLER DEFAULTS

Press to reset FTG Installer Menu items to defaults.

IR REMOTE ACCESS

Toggle IR Remote Access to ON to get access to TV feature menus or Installer Menu.

WRITE

Press to transfer the FTG Installer Menu values to the EBL.

READ

Press to transfer the Installer Menu values in the EBL to the PC FTG Configuration Application.

EXIT

Returns to Logical Channel Map Menu.

LEARN

Press to transfer the Installer Menu settings on the TV to the EBL and PC FTG Configuration Application.

The following table provides troubleshooting information for when EBL is configured in the FTG Mode of operation.

FTG Operation Error Messages

Symptom	Probable Cause(s)	Solution(s)
Communication Error ("Communications Timeout")	Cable(s) not connected.	Check and connect communication cables.
	TV not powered.	Check/connect the TV power cord.
	TV not turned ON.	TV needs to be turned ON (default FTG Mode).
	Wrong COM (communication) port.	In the FTG Configuration Application, select the correct COM port for the cable being used.

Typical Installer Remote Control

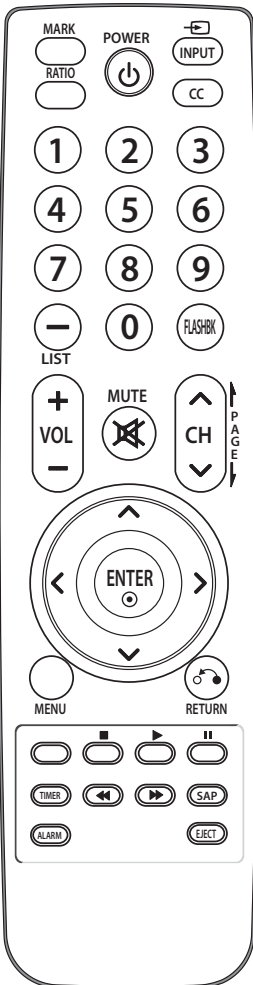

The LG Installer Remote is supplied with and dedicated to operate the TV. Some DVD and VCR controls may be available for selected LG DVD/VCR products.

See next page for typical key functions in TV Mode and DVD/VCR Control.

Follow the instructions provided in the “Installer Menu” section of this document to access the Installer Menu.

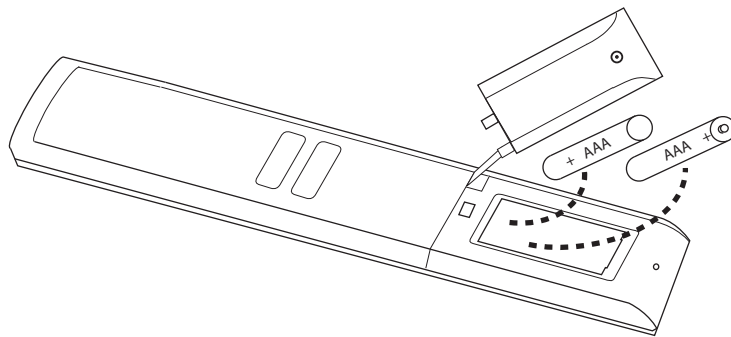

Installing Batteries in Installer Remote

- Remove the battery compartment cover on the back side of the remote by loosening the bolt on the battery compartment cover, pressing the arrow tab, and then sliding the cover downward.
- Install two high-quality alkaline 1.5V AAA batteries. Never mix old or used batteries with new ones. Install batteries matching correct polarity as shown (+ with + and - with -).
- Replace the battery compartment cover.

Installer Remote Control Key Functions

The LG Installer Remote illustrated below and throughout this document shows typical remote control functions and is provided for reference only. This Installer Remote may vary from the actual Installer Remote supplied with the TV.

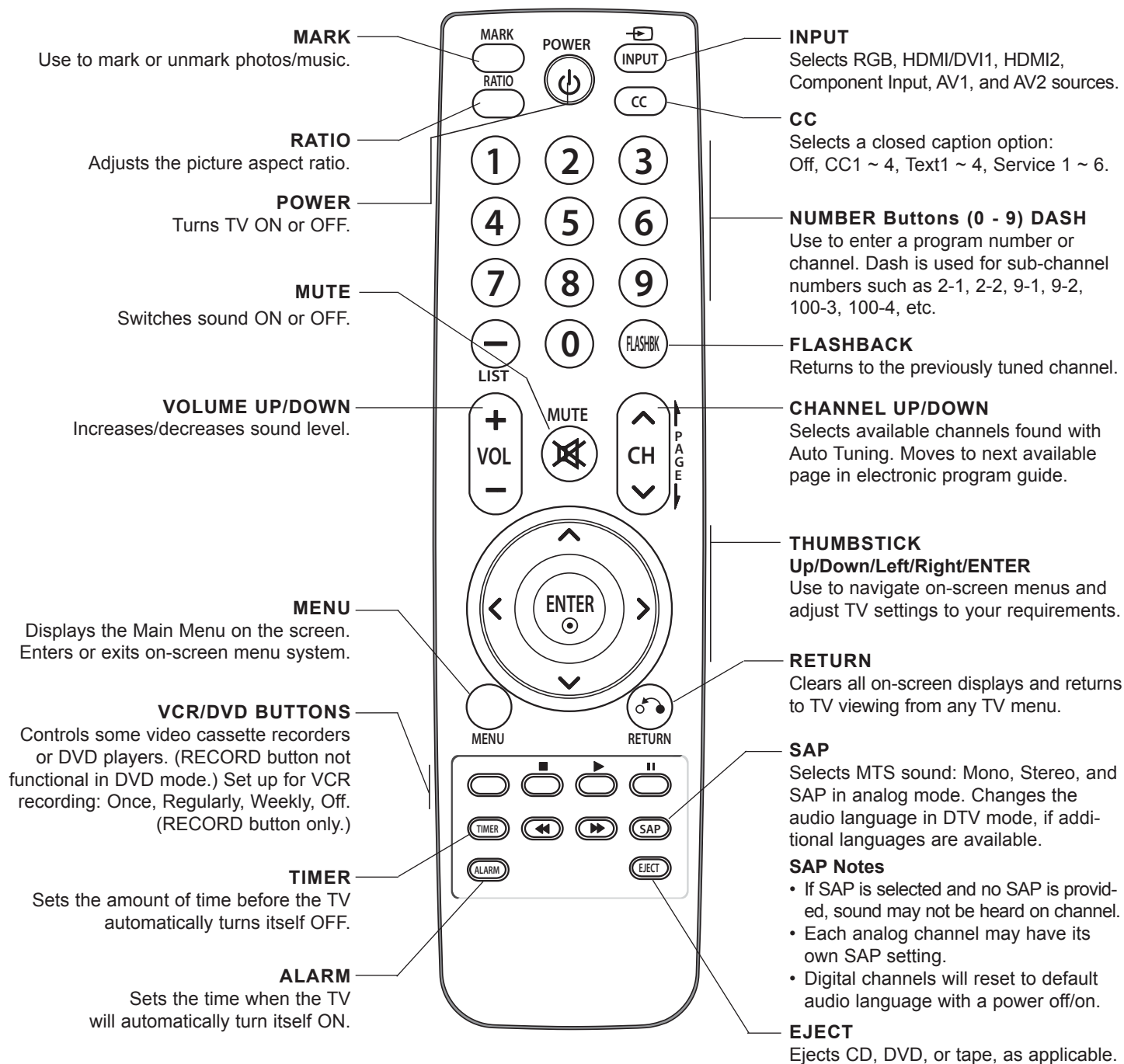

Rear Connections Panel

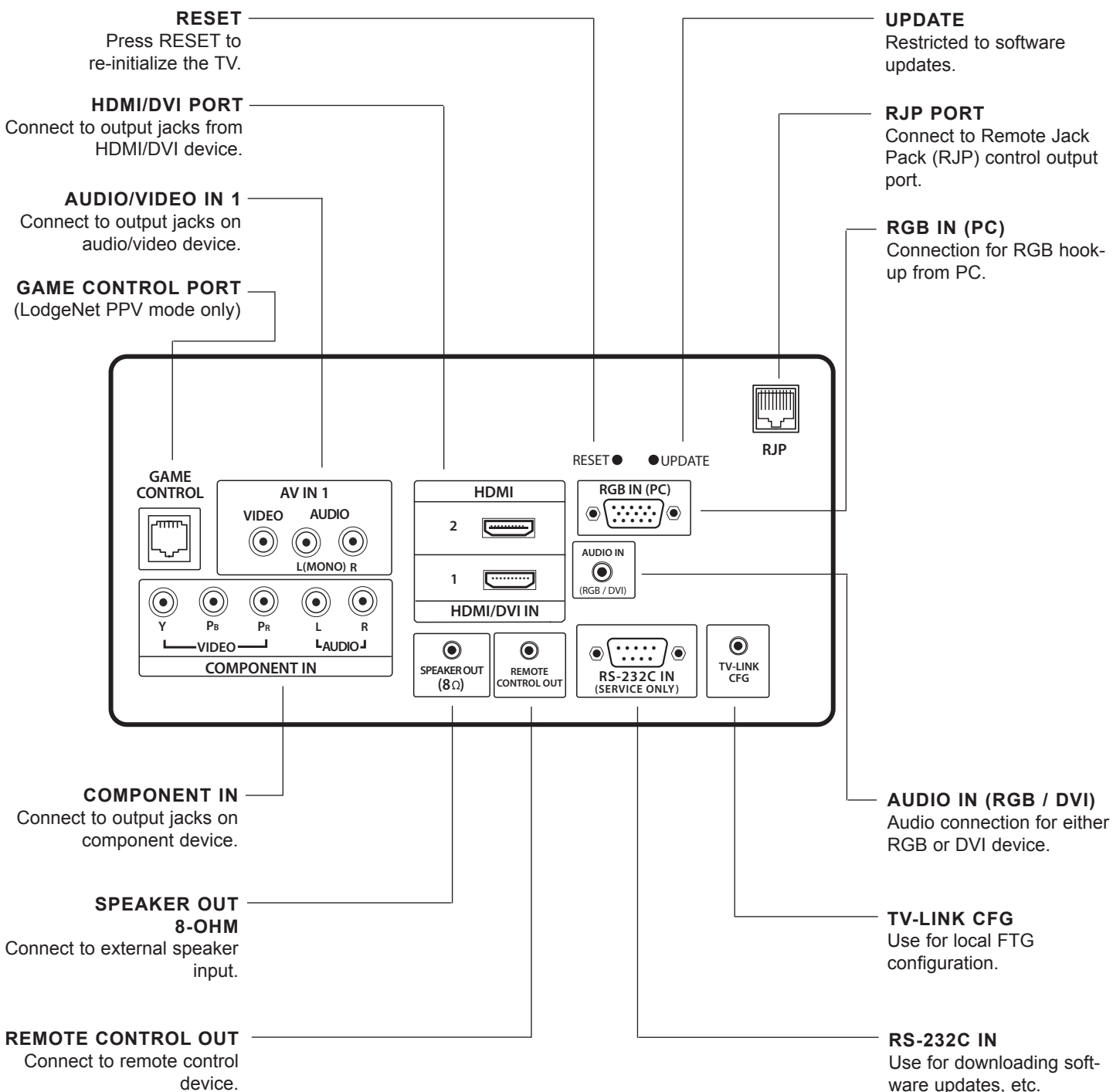

Side Connections Panel / RF Antenna Connection

Side Connections Panel

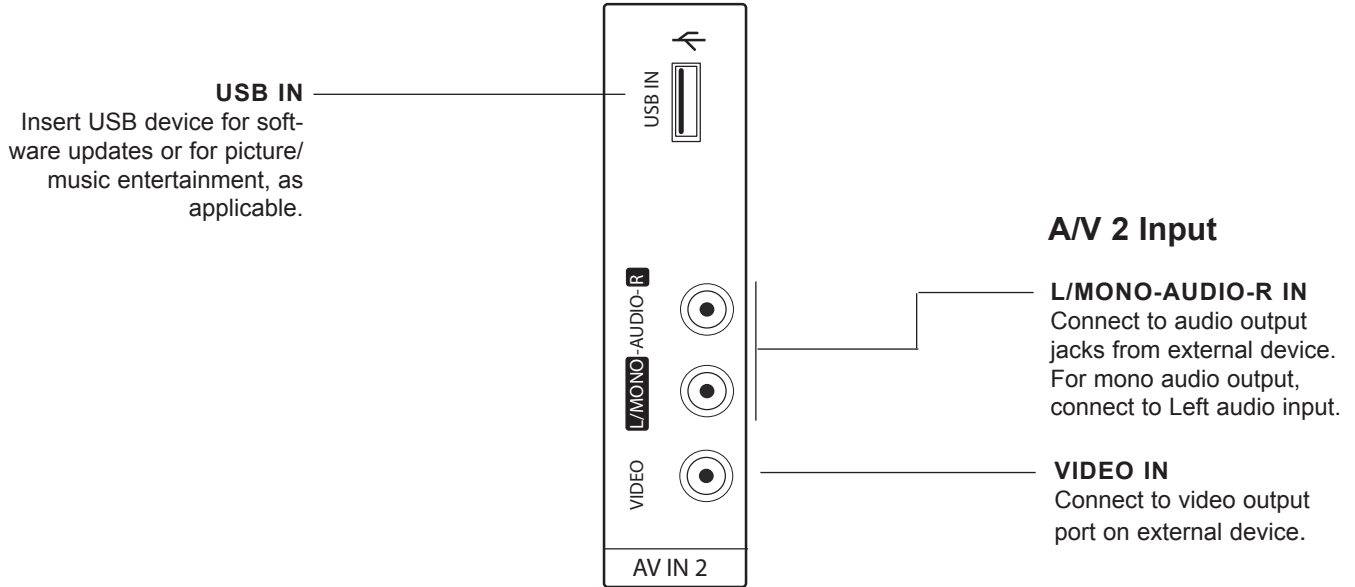

RF Antenna Connection

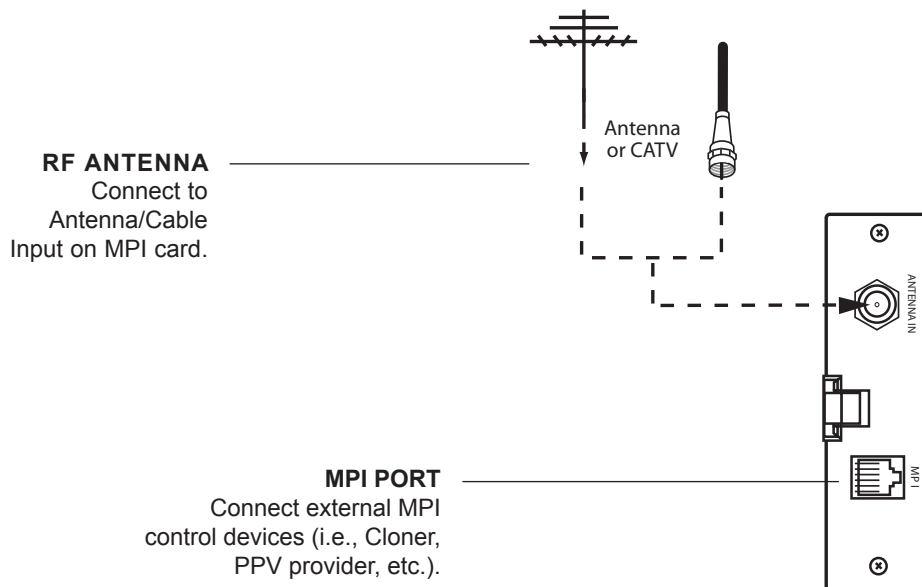

Remote Jack Pack (RJP) / TV Connections & Setup

Make these connections ONLY after Commercial Mode Setup and Cloning Master TV procedures are complete.

Remote Jack Pack Setup

RJP Available? If you will use a Remote Jack Pack in your system, set Installer Menu item **093 RJP AVAILABLE** appropriately (for example, on a legacy model RJP: HDMI Mode, set RJP AVAILABLE to 001). See Installer Menu detailed descriptions for further information.

093 RJP AVAILABLE 001

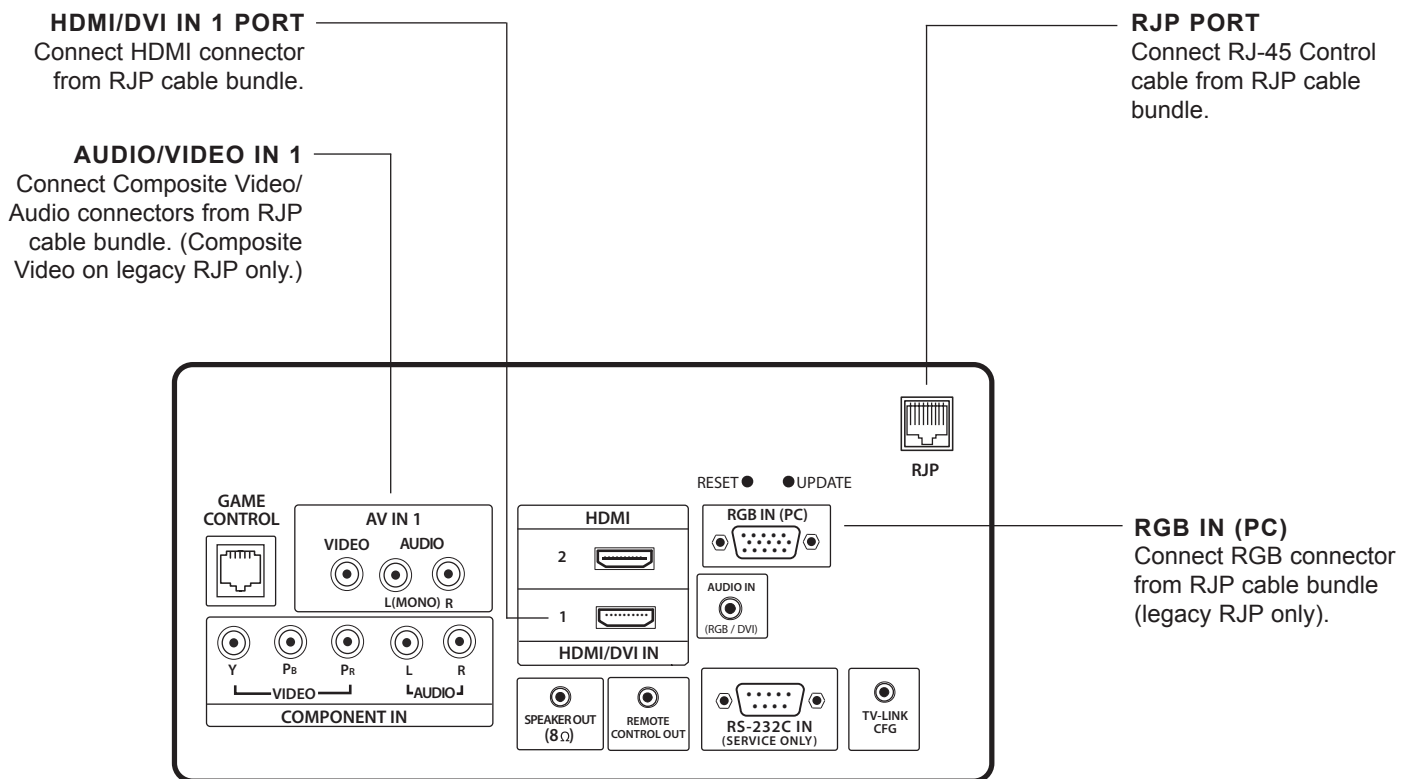

TV Features Configuration Menu Overview

The on-screen menus control basic TV features.

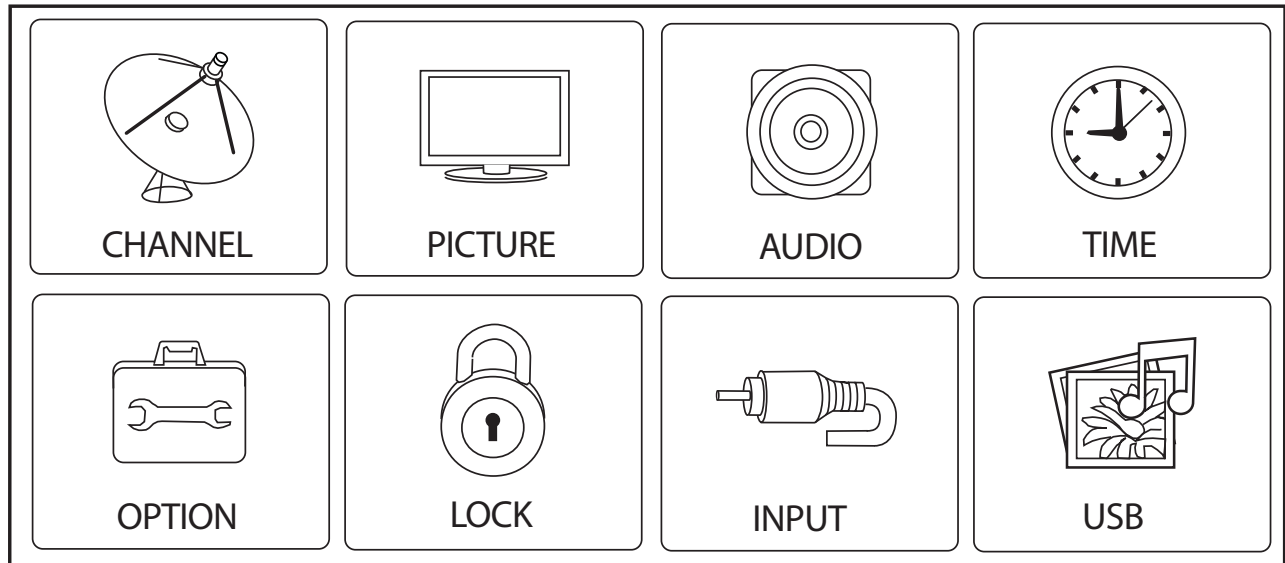

Main TV Menus

The Main TV Setup Menus control the features of the TV. Set the TV features to the desired configuration for the end user. Use the USB port to upgrade TV software.

TLL-1100A Cloning Connections / Learning Setup

Connections for the TLL-1100A Clone Programmer to Learn the Master TV Setup

On Master TV

Set up all Master TV features on the menus, and do a Channel Search. Add Channel and Aux labels, etc. Insert the MPI cable into the TV MPI port.

On TLL-1100A

1. Turn ON the TLL-1100A.
2. Use the **MODE** button to select **Clone Mode**.
3. Use the Left/Right arrow to select the CBank (1 to 8) in which to store the Master Setup.
4. Plug the other end of the MPI cable into the MPI port on the bottom of the TLL.
5. With the Installer Remote, select item **1** on the TLL Menu.
6. Press **ENTER** to transfer the Master Setup into CBankX on the TLL. The TLL will copy the Master Setup.
7. When Learning is done, disconnect the MPI cable from the Master TV.
8. Reconnect the TV power cord, and turn ON the TV. The Master Setup should be resident on the TV.

On Target TV

1. Connect the MPI cable from the TLL to the MPI port on the Target TV. Ensure that the correct CBank(X) is selected on TLL.
2. With the Installer Remote, select item **2**, to "teach" the Target TV the Master TV Setup.
3. Press **ENTER** to begin Teaching.
4. When Teaching is done, disconnect the MPI cable, and turn OFF the TV. Then, unplug the TV power cord.
5. Reconnect the TV power cord, and turn ON the TV. The Master Setup should be resident on the TV.

MPI Learning Setup

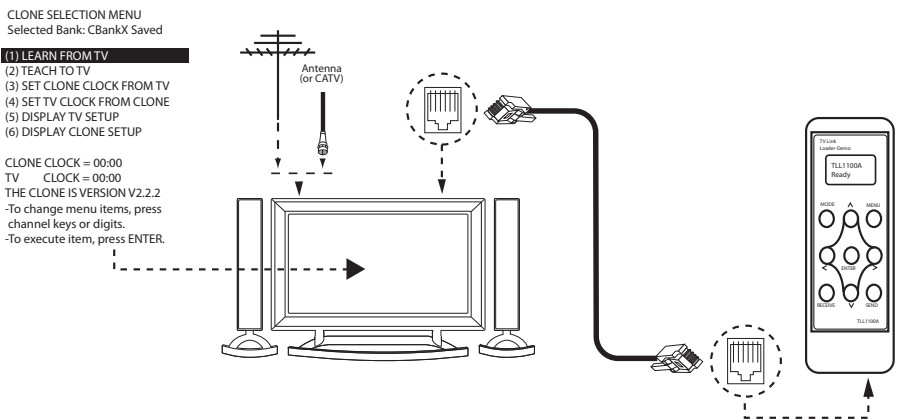

MPI Teaching Setup

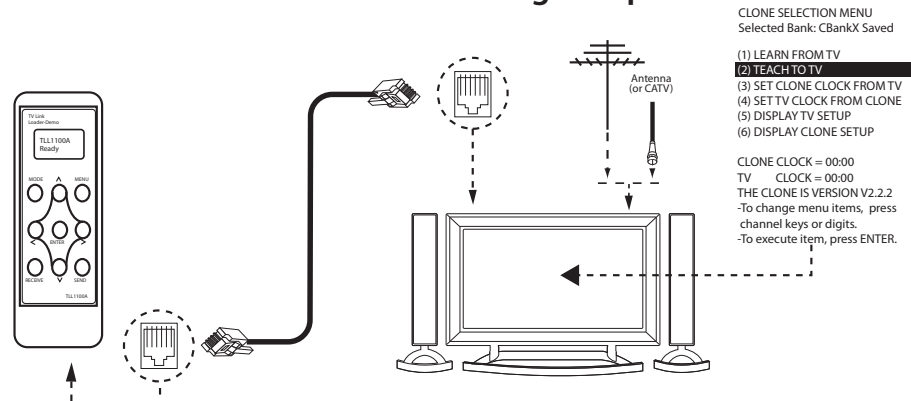

Warning: Do not use the TLL-1100A while any PPV card is installed in the TV, or the Clone Programmer device and the PPV card will be damaged.

Note: These procedures assume that the TV is connected to a signal source, the TV source selected is Antenna (RF) In, the signal is from an analog channel (not a digital channel), all equipment is connected to power and turned ON, and the TLL Cloner Main Menu is displayed on the TV screen (see above).

► If an analog channel is not available, tune the TV to an Aux source, such as AV-1, for cloning purposes.

LT2002 Cloning Connections / Learning Setup

Connections for the LT2002 Clone Programmer to Learn the Master TV Setup

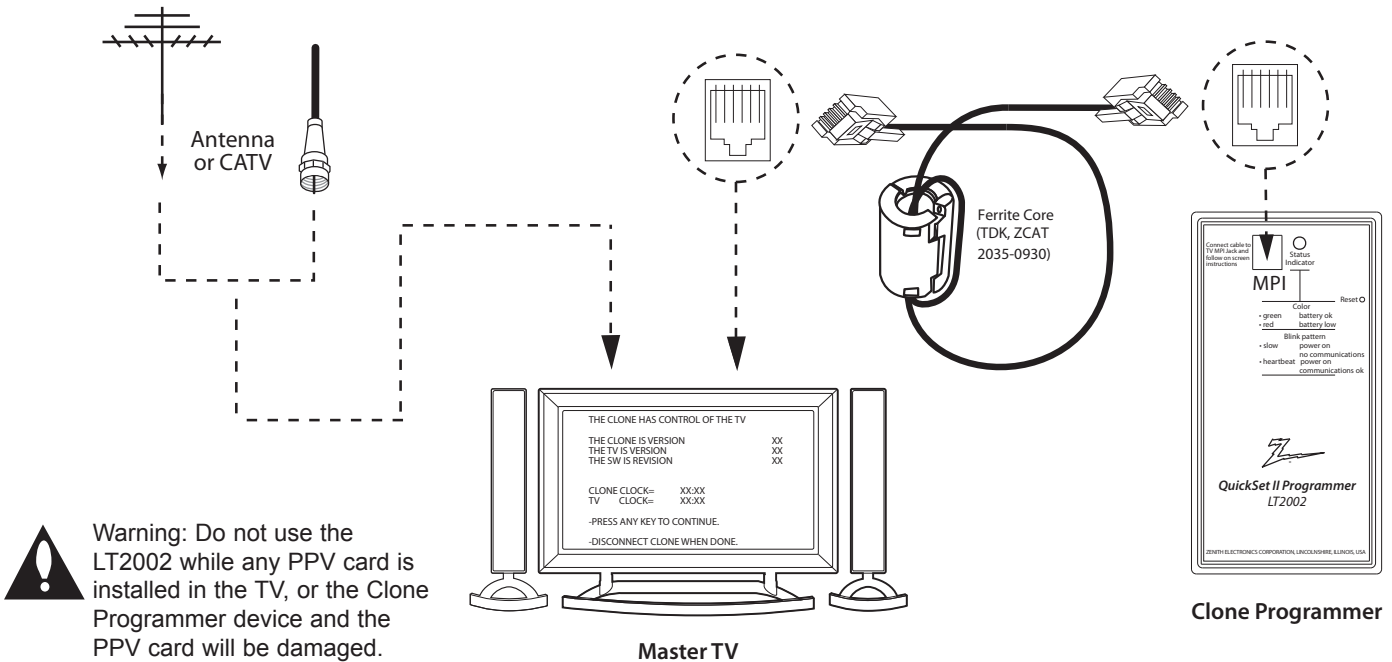

Note: These procedures assume that the TV is connected to a signal source, the TV source selected is Antenna (RF) In, the signal is from an analog channel (not a digital channel), all equipment is connected to power and turned ON, and the LT2002 Clone Programmer main menu (THE CLONE HAS CONTROL OF THE TV) is displayed on the TV screen (see above and next page).

► If an analog channel is not available, tune the TV to an Aux source, such as AV-1, for cloning purposes.

Before you begin cloning:

- The Master TV should be connected to a good, stable signal from an over-the-air antenna or cable service analog channel and should also be connected to power (see above).
- Teaching and Learning is only possible between identical model devices. (However, the LT2002 Clone Programmer can store up to three different “Master” Setups.)
WARNING: Copying a blank or incorrect memory into a TV, STB, or other device will cause the TV, STB, or other device to operate erratically or become inoperable.
- Use an Installer Remote to operate Learning and Teaching menus.
- Make sure the batteries in the Clone Programmer are fresh.
- If batteries are removed, the Clone Clock Time will be lost.
- Decide if you want to set the time from the Clone Programmer or copy the time to the Clone Programmer from a compatible TV which has the clock set to the current time.
- Setting the time and transferring it to the Clone Programmer or other device is a separate procedure.
- Follow the connection diagram above to connect the Clone Programmer to a Master TV display panel. After Learning is complete, connect to another identical TV display panel to “teach” it the Master Setup.
- Refer to “LT2002 Cloning Procedure Troubleshooting” information to resolve problems.

Continue the Cloning Setup on the next page.

LT2002 Cloning Connections / Learning Setup (Cont.)

Learning the Master TV Setup

Instructions for the Clone Programmer to Learn the Master TV Setup

Use the MPI Cable to Connect the LT2002 Clone Programmer to the Master TV MPI Port

If there is a good connection, "THE CLONE HAS CONTROL OF THE TV" message will appear. Press any key on the Installer Remote.

Learn Setup from Master TV

Press **1** to select the **LEARN FROM TV** option; then press **ON/OFF**, **POWER**, or **ENTER** to go to the Memory Bank Selection Menu. Select the Memory "Bank" in which you want to store the Master TV Setup by pressing either Channel key repeatedly to choose Memory 1, 2, or 3. (If you choose a Memory Bank that has a Master device's setup programmed into it, that setup will be overwritten by the new Master TV's Setup.) Once you select the Clone Memory Bank, press **ON/OFF**, **POWER**, or **ENTER**. The Clone Memory Bank you have selected will be shown. Press **ON/OFF** or **POWER** to begin copying the Master TV Setup.

Set the Clock (Optional)

Set the time on a Master TV's clock. (If the time has already been copied from a TV into the Clone Programmer, you can set a Master TV's clock by copying the time from the Clone Programmer.) The Clone Programmer can copy the current time to both a Master TV and to the Clone's internal clock—accurate to within one minute. (Another reason that the Clone Programmer should be equipped with fresh, high-quality alkaline batteries, is for it to keep the time as accurately as possible.)

Since the Clone Programmer's time cannot be set directly, the current time needs to be copied from an LG TV equipped with MPI input capability.

After the time is copied to the Clone Programmer, the current time can then be transferred to another TV. (This can be a Master TV or another TV which has already had the features set up.)

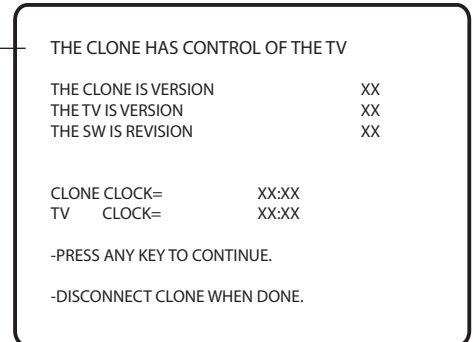

This menu should appear by itself after the LT2002 is connected to the TV MPI port.

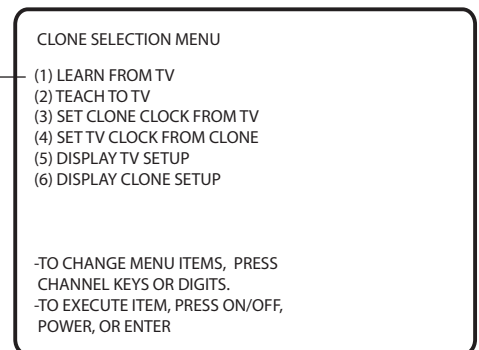

This menu should appear after any key is pressed on the Installer Remote.

LT2002 Clone Programmer Communication Problems

- A slow flashing green light indicates that there are communication problems between the TV and the LT2002 Clone Programmer. If this is the case, check for a damaged cable, poor contacts, or other connection troubles.
- If the status indicator is red, the Programmer batteries are low and should be replaced. Install four (4) high-quality alkaline AA batteries.

LT2002 Cloning Connections / Teaching Setup

Teaching the Master Setup to Another TV

Connections for the LT2002 to Teach Another TV the Master Setup

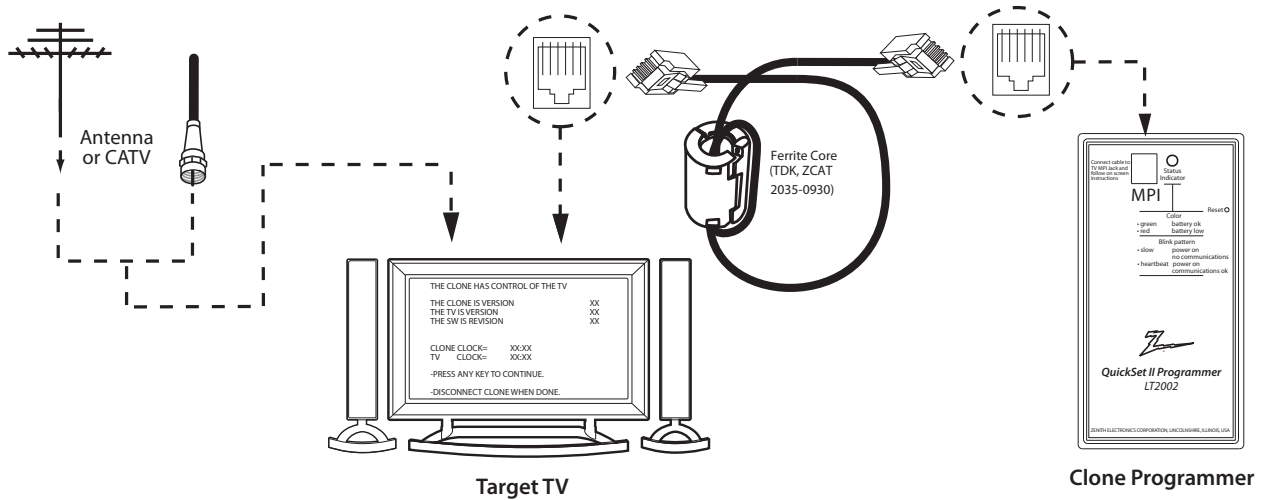

► If an analog channel is not available, tune the TV to an Aux source, such as AV-1, for cloning purposes.

Teach Master TV Setup to Target TV

After Learning is complete, remove the MPI cable from the Master TV, and connect it to the Target TV into which you wish to copy the Master TV Setup. With “THE CLONE HAS CONTROL OF TV” message displayed, press **2** or use either Channel key to select the **TEACH TO TV** option, and press **ON/OFF**, **POWER**, or **ENTER**. Select the LT2002 memory in which the new setup is located. Press **ON/OFF** to transfer the new setup and other information to the new TV. Teaching usually takes 2 to 3 minutes. After the “TEACHING COMPLETE” message is displayed, press any key to return to the Clone Selection Menu; then press **ON/OFF**, **POWER**, or **ENTER**. When finished, detach the MPI cable from the target, newly-cloned TV.

Disconnect TV Power for 15 Seconds

Unplug the AC power cord of the newly-cloned TV from the power outlet for about 15 seconds to activate the newly-copied setup.

CLONE SELECTION MENU
(1) LEARN FROM TV
(2) TEACH TO TV
(3) SET CLONE CLOCK FROM TV
(4) SET TV CLOCK FROM CLONE
(5) DISPLAY TV SETUP
(6) DISPLAY CLONE SETUP

-TO CHANGE MENU ITEMS, PRESS CHANNEL KEYS OR DIGITS.
-TO EXECUTE ITEM, PRESS ON/OFF, POWER, OR ENTER

This menu should appear after any key is pressed on the Installer Remote.

TEACHING IN PROGRESS,
PLEASE WAIT

This display will appear during Teaching function.

TEACHING COMPLETE

This display will appear after Teaching is complete.

Installer Menu

Use the Installer Menu to set up or change operational settings. See more detailed descriptions of the Installer Menu items on the pages that follow.

Accessing the Installer Menu

Make sure the TV is ON. Using an Installer Remote, press **MENU** repeatedly until the on-screen menu locks up, and then press **9-8-7-6 + ENTER** to access the Installer Menu. To exit the Installer Menu, press **ENTER** again. Any changes you make will be stored in non-volatile memory.

The Installer Menu opens with item 000 INSTALLER SEQ 000. Use the Up/Down arrow keys to sequence through the available menu items, or access an item directly by keying in the line number and then pressing MENU. For example, to access the SLEEP TIMER option, which is item 015, press 0-1-5 + MENU. To change a setting, use the Left/Right arrow keys, or enter a value directly.

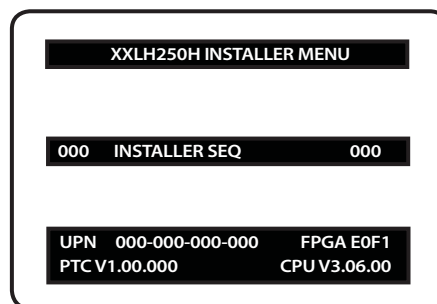

Typical TV Installer Menu

Note: The Installer Menu header will vary depending on the TV you are setting up.

Using the Installer Menu

Items 000 ~ 118 are immediately accessible only upon entering the Installer Menu. Refer to the table below as well as the following pages for item numbers, descriptions, ranges, factory default settings, and a place for listing any changes made on-site. Installer Menu items not relevant to this TV series are not present on the Installer Menu; therefore, some numbers are missing. For example, items 006, 012, 013, etc. will not appear.

Installer Menu Items 000 through 030

Menu Item	Function	Value Range	Default Value	Brief Description of Function and Comments
000	INSTALLER SEQ	0 ~ 3	0	Leave default set to 0.
001	POWER MANAGE	0 ~ 7	0	Sets number of hours of no activity before automatic shutoff.
002	AC ON	0 / 1	0	Set to 1 to enable Auto Turn On at power up.
003	BAND/AFC	0 ~ 3	1	Selects Tuning Band: 0=Broadcast, 1=CATV, 2=HRC, 3=IRC
004	STRT CHANNEL	0 ~ 127, 255	255	Channel at turn-on. (Set to 255 to tune in last channel before power Off.)
005	CHAN LOCK	0 / 1	0	If set to 1, cannot tune from current channel.
007	STRT VOLUME	0 ~ 63, 255	255	Sets volume level at TV turn-on. (Set to 255 to retain last volume level.)
008	MIN VOLUME	0 ~ 63	0	Sets minimum allowable volume setting.
009	MAX VOLUME	0 ~ 63	63	Sets maximum allowable volume setting.
010	MUTE DISABLE	0 / 1	0	Set to 1 to disable Mute Function.
011	KEY DEFEAT	0 / 1	0	Set to 1 to disable menu navigation keys on display panel.
015	SLEEP TIMER	0 / 1	1	Set to 1 to enable Sleep Timer.
016	EN TIMER	0 / 1	0	Set to 1 to enable On/Off Timers.
017	ALARM	0 / 1	1	Set to 1 to enable Alarm.
021	V-CHIP	0 / 1	1	Set to 1 to enable V-Chip (Parental Control) functions.
022	MAX BLK HRS	0 ~ 99	12	Sets number of V-Chip blocking hours.
023	CAPTION LOCK	0 / 1	0	Set to 1 to retain caption setting at power off.
028	CH. OVERRIDE	0 / 1	1	If set to 0, limits direct access to favorite channels.
029	OLD OCV	0 / 1	0	Set to 1 to change MPI operation to OCV.
030	ACK MASK	0 / 1	0	If set to 1, changes MPI for some OCV boxes.

Installer Menu Items 031 through 118

Menu Item	Function	Value Range	Default Value	Brief Description of Function and Comments
031	POLL RATE	20 ~ 169	94	Selects poll rate for MPI.
032	TIMING PULSE	186 ~ 227	207	Sets baud rate for MPI.
034	CAMPORT EN	0 / 1	1	Set to 1 to enable Video 2 input.
035	COMPPORT EN.	0 / 1	1	Set to 0 to disable HDMI 1. Set to 1 enable HDMI 1.
038	YPrPb EN.	0 / 1	1	Set to 1 to enable display panel Component Video 1 input jacks.
039	REAR AUX EN	0 / 1	1	Set to 1 to enable display panel Video 1 input jack.
040	AUTO CAMPORT	0 / 1	1	Set to 1 to automatically switch to Camport. If set to 1, STRT AUX SRCE cannot be set to 2.
046	STRT AUX SRCE	1 ~ 6, 255	6	Sets the starting Aux source.
047	AUX STATUS	0 / 1	0	Set to 1 for MPI Aux source to be reported as a channel number instead of Channel 0.
053	DIS. CH-TIME	0 / 1	0	Set to 1 to disable Channel-Time display.
069	EN. CH-T COL.	0 / 1	1	Set to 1 to enable custom color for the Channel-Time display.
070	FOR. CH-TIME	0 ~ 7	2	Chooses custom foreground color for the Channel-Time display.
071	BCK. CH-TIME	0 ~ 7	2	Chooses custom background color for the Channel-Time display.
073	CH NOT AVBLE	0 / 1	0	If set to 1 and Channel Override is 0, "NOT AVAILABLE" message is displayed when directly accessing a channel not in the favorite Channel List.
075	REVERT CH	0 / 1	0	If set to 1 and loss of MPI communication occurs, TV tunes to Start Channel.
078	UPN MSB	0 ~ 255	0	User programmable number, most significant byte.
079	UPN MSB-1	0 ~ 255	0	User programmable number, most significant byte - 1.
080	UPN MSB-2	0 ~ 255	0	User programmable number, most significant byte - 2.
081	UPN LSB	0 ~ 255	0	User programmable number, least significant byte.
082	CHKSM ERROR	0 / 1	1	Enforces rigid MPI checksum.
083	HANDSHK TIME	0 ~ 5	5	Relaxes MPI timing to be compatible with PC-based Windows®-controlled systems.
084	PERMANENT BLK	0 / 1	0	Removes block hours setting for Parental Control and makes block permanent.
087	REAR RGB EN.	0 / 2 / 18	2	Set to 0 to disable RGB1. Set to 2 to enable for PC and Auto Configure always enabled. Set to 18 to enable for PC and Auto Configure one time only after AC ON.
088	EN NOISE MUTE	0 / 1	1	If set to 1, audio is muted if no signal is present.
090	KEY LOCK	0 / 1	0	If set to 1, keyboard is locked out, IR is still functional.
091	YPrPB2 EN	0 / 1	1	Set to 1 to enable HDMI 2 input.
093	RJP AVAILABLE	0 1 2 5 6	0	Set to 0 to disable. Set to 1, 2, 5, or 6 for HDMI or DVI Mode. (See detailed descriptions.)
094	SAP MENU EN	0 / 1	1	Set to 0 to disable feature on Function Menu. Set to 1 to enable feature on Function Menu.
096	DEF. ASP. RATIO	0 ~ 4	2	Sets default aspect ratio at power up. See detailed descriptions and item 106.
099	BACK LIGHTING	1 ~ 100, 101 ~ 200, 255	200	Sets the brilliance of the TV picture backlighting. Settings above 101 control dynamic back lighting and disable power savings mode.
102	ATSC BAND	0 ~ 4	4	Selects ATSC band.
103	ATSC TUNE MODE	0 / 1	1	Set to 1 (default) for Physical Channel scan. Set to 0 for Virtual Channel scan.
104	START MINOR CH	0 ~ 255	0	Selects Minor Start Channel. Set to 0 for NTSC.
106	ASP RATIO LOCK	0 / 1	0	To retain set aspect ratio on power cycle, set to 1. Set to 0 for default ratio on power cycle.
116	VIDEO MUTE EN	0 / 1	0	Set to 0 for Normal. Set to 1 for Blank.
117	FACT DEFAULT	0 / 1	0	Set to 0 for Normal. Set to 1 to load presets of all above settings.
118	POWER SAVINGS	1, 3, 7	3	Set to 1 (b-LAN module is always powered), set to 3 (b-LAN module only powered when TV is turned ON), or set to 7 (b-LAN module is never powered).

Installer Menu (Cont.)

Detailed Descriptions of Installer Menu Items

000 - INSTALLER SEQUENCE

Specifies entry sequence to the Installer Menu.

0 = 9876	1 = 4321
2 = 1478	3 = 3698

001 - POWER MANAGE (Power Management)

Determines hours of no activity before automatic shutoff. The Power Management function is for saving energy. If set to 0, Power Manage is Off. Settings range from 0 ~ 7, with 1 ~ 7 representing the hours that the unit will remain ON, unless there has been activity from either the control panel or remote control.

002 - AC ON (AC Power Switchable)

If set to 1, this allows the TV to turn ON when AC power is applied. Pressing the ON button is not necessary. This is desirable if the TV is plugged into a cable box or a power outlet controlled by a wall switch. Use the ADJ Left/Right arrow to choose 0 or 1, where 0 is the default (OFF), and 1 is ON.

Note: If set to 1 (ON), the TV does not respond to On/Off commands from either the remote or the display control panel, and the SLEEP TIMER is also nonfunctional.

003 - BAND/AFC (Band/Automatic Frequency Control)

There are four possible settings for this option:

0 = Broadcast	1 = CATV
2 = HRC	3 = IRC

If some channels were not found by Auto Tuning (Channel Search), select the appropriate Band setting here, and add the channels using the Channel Edit option in the Channel Menu.

004 - STRT CHANNEL (Start Channel)

If active, this function allows you to determine the initial channel number when the TV is turned ON. This feature is useful for an in-house information channel, since the TV would always select that channel when it is turned ON. Setting this to 255 causes the last channel viewed when the TV was turned OFF, to be the tuned to channel when the TV is turned ON again.

Note: For a digital Start Channel, always remember to set item 104 to the Minor Start Channel number.

255 = Last channel	1 ~ 125 = Ch X	0 = Aux
126 Map to Channel 3.	127 Map to Channel 4.	

005 - CHAN LOCK (Channel Lock)

Channel Lock is ideal if the system must always be on the same channel. Changing channels with the Channel Up/Down or keypad numbers is impossible. Channel Lock is inactive if set to 0 (default).

Generally, this feature is used in connection with STRT CHANNEL (Installer item 004) where the Start Channel may, for example, be set to 3 or 4. If the Start Channel is 3, then the TV will remain locked on channel 3.

NOTE: For items 007, 008, and 009

For legacy reasons, the scale used is 0 - 63. The PTC software will translate this to the 0 - 100 scale used by the TV.

To translate a TV volume level to the Installer Menu value, use the following formula:

$$\text{Installer Value} = \frac{\text{TV Value} \times 63}{100}$$

Enter only the whole number (disregard fractions).

007 - STRT VOLUME (Start Volume)

This function allows the Installer to determine the initial volume level setting when the TV is turned ON. This feature is useful for an in-house information channel, since the TV would always select that volume level when it is turned ON. The range of values are 0 - 63, 255. If 255 is selected, the current volume level will be retained in memory when the TV is turned OFF; at turn ON, the volume level will be automatically set at the previous or last level.

008 - MIN VOLUME (Minimum Volume)

This function determines the minimum volume level allowable with the VOLUME (VOL) Up/Down control. In this way, for example, someone cannot set the volume too low to hear. The value range is from 0 to 63 — change values with ADJ Left/Right arrow. The factory default is 0, which provides the full range of volume control, if item 009 MAX VOLUME is also set to 63. It may be best to set the same value on every TV.

Note: The minimum volume level cannot have a value setting higher than the maximum volume level (described below).

009 - MAX VOLUME (Maximum Volume)

This function determines the maximum volume level allowable with the VOLUME (VOL) Up/Down controls. In this way, for example, someone can not set the volume level high enough to disturb others. The value range is 0 to 63, with 63 as the default, which gives the user the full range of volume control, if item 008 MIN VOLUME is also set at 0. Change values with ADJ Left/Right arrow keys. It may be best to set the same value on every TV.

Note: The maximum volume level cannot have a value setting lower than the minimum volume level (described above).

010 - MUTE DISABLE

Enables or disables sound mute function. If set to 1, sound cannot be muted. If set to 0, sound can be muted.

011 - KEY DEFEAT (Keyboard Defeat)

If set to 1, KEY DEFEAT prevents the end user from accessing the on-screen menus with the display front panel—MENU, SELECT, and Left/Right arrow keys do not function. If set to 0, those keys do function.

Note: The menus can always be accessed by pressing MENU on the remote.

015 - SLEEP TIMER

If set to 1, the Sleep Timer feature may be used. If set to 0, the Sleep Timer is not available.

016 - EN TIMER (Enable On/Off Timers) *

If set to 1, the Timer function is available to the end user and enabled continuously. Set to 0 to disable On/Off Timers.

Note: Clock must be set in order to use timers.

017 - ALARM *

Gives the installer the option of making the Alarm function available to the end user. If set to 1, the Alarm function is available to the end user. Set to 0 to disable the Alarm function.

Note: Clock must be set before the Alarm function will work.

021 - V-CHIP (Parental Control) *

Set to 1 to activate V-Chip (Parental Control) and have it available to the end user to filter and control or otherwise restrict programming content that can appear. Set to 0 to turn the V-Chip feature Off (not available to user); no programming restrictions can be set.

022 - MAX BLK HRS (Maximum Block Hours) *

Sets hours from 0 to 99 for the maximum V-Chip (Parental Control) block hours. Default setting is for 12 blocking hours.

023 - CAPTION LOCK

Set to 1 to restore previous Caption On/Off state after turn Off. If set to 0, captions are always Off at turn On.

028 - CH. OVERRIDE (Channel Override)

If set to 1, the user can select channels with either Channel Up/Down or direct keypad entry. If set to 0, only those channels that are entered for scanning can be selected, and TV Setup Menu access is also unavailable.

029 - OLD OCV (On Command Video™)

Set to 1 for operation with systems from On Command Corporation.

030 - ACK MASK

MPI Communication parameter. Leave at default setting unless changed by Pay-Per-View provider. When set to 1, changes MPI for some OCV boxes.

031 - POLL RATE

MPI Communication parameter. Selects Poll Rate for MPI. Leave at default setting unless changed by Pay-Per-View provider. Step size of 16 ms.

032 - TIMING PULSE

MPI Communication parameter. Leave at default setting unless changed by Pay-Per-View provider. Sets baud rate. Step size of 4.3 uS.

* Only affects Function Menu if enabled by some PPV providers.

034 - CAMPORT EN. (Camera Port Enable)

Set to 1 to enable Video 2 input on display panel. If set to 0, Video 2 input on display panel is not functional.

Note: S-Video overrides Video.

035 - COMPPORT EN. (Computer Port Enable)

Enable/disable display panel HDMI1 input jack. Set to 0 to disable HDMI1. Set to 1 to enable HDMI1.

Note: The setting above is ignored if Installer Menu item 093 RJP AVAILABLE is set to 1.

038 - YPrPb EN. (Rear Component Video Enable)

Set to 1 to enable display panel rear Component Video input jacks. Set to 0 to disable display panel rear Component Video input jacks.

039 - REAR AUX EN. (Rear Aux Enable)

Set to 1 to enable display panel rear AUX (Video 1) input. Set to 0 to disable display panel rear AUX (Video 1) input.

Note: S-Video overrides Video.

040 - AUTO CAMPORT

Set to 1 to automatically switch to Camport when equipment is connected to front Video input. Set to 0 to disable front Video automatic source selection.

Note: If set to 1, item 093 RJP AVAILABLE is automatically set to 0.

046 - STRT AUX SRCE (Start Aux Source)

Sets the starting Aux source. At power up, TV will tune to starting Aux source if item 004 STRT CHANNEL is set to 0. If item 093 RJP AVAILABLE is set to 0 and item 040 AUTO CAMPORT is set to 0:

1 = Video 1	4 = RGB	255 = Last Aux
2 = Video 2	5 = HDMI 2	
3 = HDMI 1	6 = Component	

If item 093 RJP AVAILABLE is set at 1:

2 = Video 2	5 = HDMI 2	6 = Component
-------------	------------	---------------

If item 040 AUTO CAMPORT is set to 1:

1 = Video 1	5 = HDMI 2
3 = HDMI 1	6 = Component
4 = RGB	

047 - AUX STATUS

Set to 1 for MPI Aux source to be reported as a channel number instead of channel 0. Set to 0 to disable Aux identification change. Controls MPI status channel response for Aux inputs.

053 - DIS. CH-TIME (Disable Channel-Time)

Set to 1 to disable the Channel-Time display; Channel-Time display will not appear. Set to 0 to enable the Channel-Time display.

Installer Menu (Cont.)

069 - EN. CH-T COL. (Enable Channel-Time Custom Color)

Set to 1 to enable custom color for the Channel-Time display. Set to 0 to disable custom color for the Channel-Time display.

070 - FOR. CH-TIME (Channel-Time Display Foreground Color)

Set according to Color Chart:

0 = Black	3 = Cyan	6 = Yellow
1 = Blue	4 = Red	7 = White
2 = Green	5 = Violet	

Note: If foreground and background colors are the same, menu background is transparent.

071 - BCK. CH-TIME (Channel-Time Display Background Color)

Set according to Color Chart:

0 = Black	3 = Cyan	6 = Yellow
1 = Blue	4 = Red	7 = White
2 = Green	5 = Violet	

Note: If foreground and background colors are the same, menu background is transparent.

073 - CH NOT AVBLE (Channel Not Available)

If set to 1 and item 028 CH. OVERRIDE is set to 0, a "NOT AVAILABLE" message is displayed when directly accessing a channel not in the channel scan list available in memory.

075 - REVERT CH (Revert to Start Channel)

If set to 1 and loss of MPI communication occurs, TV automatically tunes to the specified Start Channel.

078 - UPN MSB (UPN Most Significant Byte)

User-programmable number; most significant byte readable by MPI command. **Note:** Not linked to serial number.

079 - UPN MSB-1 (UPN Most Significant Byte-1)

User-programmable number; most significant byte-1 readable by MPI command. **Note:** Not linked to serial number.

080 - UPN MSB-2 (UPN Most Significant Byte-2)

User-programmable number; most significant byte-2 readable by MPI command. **Note:** Not linked to serial number.

081 - UPN LSB (UPN Least Significant Byte)

User-programmable number; least significant byte readable by MPI command. **Note:** Not linked to serial number.

082 - CHKSM ERROR (Checksum Error)

Enforces rigid MPI checksum validation. Set to 1 for validation. Set to 0 to disable (does not check checksum on MPI async port). SPI is always checked.

083 - HANDSHK TIME (Handshake Time)

Adds an additional delay to the handshake time, which is 64 msec, thus relaxing MPI timing requirements to be compatible

with PC-based Windows-controlled systems. Range is 0 - 5. (Timeout = 25.5MS + [25.5 MS* Handshake time].)

084 - PERMANENT BLK (Permanent Block)

Allows Lock (Parental Control) blocking schemes to be permanent by disabling the blocking hours function. Set to 1 to install Parental Control restrictions permanently. Set to 0 for user-specified hours control of blocking schemes.

087 - REAR RGB EN. (Rear RGB Enable)

Controls access to rear RGB input on TV. Set to 0 to disable RGB input. Set to 2 to enable for PC and Auto Configure always enabled. Set to 18 for Auto Configure one time only with power cord removal and reinsertion.

088 - EN NOISE MUTE (Enable Noise Mute)

If set to 1, audio is muted if no signal is present.

090 - KEY LOCK

If set to 1, display panel keyboard is locked out and not available to end user. IR receiver remains functional.

091 - YPrPb2 EN. (HDMI2 Enable)

Set to 0 to disable display panel HDMI2 input. Set to 1 to enable DTV mode. Set to 2 to enable PC mode.

093 - RJP AVAILABLE (Remote Jack Pack Available)

- **0 = Remote jack pack is not available or disabled.**

- **1 = Legacy Model RJP: HDMI Mode**

Enables RJP when an HDMI cable is inserted into RJP. Video is from HDMI. Audio stream is expected from HDMI source. If no audio is present, no audio will be heard.

- **2 = Legacy Model RJP: DVI Mode**

Enables RJP when an HDMI cable is inserted into RJP. Video is from HDMI; however, Audio is from selected audio source, based on the RJP's audio hierarchical priority.

- **5 = Scaler Model RJP: HDMI Mode**

Enables RJP when an HDMI cable is inserted into RJP. Video is from HDMI. Audio stream is expected from HDMI source. If no audio is present, no audio will be heard.

- **6 = Scaler Model RJP: DVI Mode**

Enables RJP when an HDMI cable is inserted into RJP. Video is from HDMI; however, Audio is from selected audio source, based on the RJP's audio hierarchical priority.

Notes:

See Reference section, "RJP Model List and Input Auto-sensing Hierarchy." If RJP AVAILABLE is set to 1, 2, 5, or 6, item 040 AUTO CAMPORT is automatically set to 0. Settings 1, 2, 5, and 6 allow the lodge staff to customize each TV's RJP setup based on customer requirements.

094 - SAP MENU EN (2nd Audio Program)

Set to 1 to enable SAP feature on Function menu, if Function menu is available. Set to 0 to disable SAP feature on Function menu, if Function menu is available.

096 - DEF. ASP. RATIO (Default Aspect Ratio)

Selects default aspect ratio at power up.

- Set to 0 for Set By System.
- Set to 1 for 4:3.
- Set to 2 for 16:9 (Factory Default).
- Set to 3 for Just Scan.
- Set to 4 for Zoom.

099 - BACK LIGHTING

Sets the TV screen brightness at power up. Default setting is 200.

- **1 - 100 Static Backlighting.**
(1 = Dimmest picture, 100 = Brightest picture.)
- **101 - 200 Dynamic Backlighting.**
(101 = Dimmest picture, 200 = Brightest picture.)

If settings are above 101, the TV automatically controls backlighting depending upon the picture level of the current program. Set to 255 to disable power savings mode.

102 - ATSC BAND

Sets up TV to receive different types of incoming signals:
0=Broadcast, 1=CATV, 2=HRC, 3=IRC, 4=Same as NTSC.

103 - ATSC TUNE MODE

Sets ATSC tuning mode. Default set to 1 for Physical Channel scan. Set to 0 for Virtual Channel scan.

104 - START MINOR CHANNEL

Sets XXX-XXX Minor Start Channel number at power up.
0=NTSC. If not 0, number selected is the Minor Start Channel number.

106 - ASP RATIO LOCK (Aspect Ratio Lock)

Set to 1 to retain previous aspect ratio with power off.
Set to 0 to retain default aspect ratio with power off. See item 096 DEF. ASP. RATIO above.

116 - VIDEO MUTE EN (Video Mute Enable)

Set to 0 for Normal. Set to 1 for Blank.

117 - FACT DEFAULT (Factory Default)

Set to 0 for Normal. Set to 1 to load presets of all item settings.



WARNING: If set to 1, this will reload the factory defaults and clear the Channel List, including any assigned channel icons and custom channel labels.

118 - Power Savings

Default is set to 3. When the TV is in Standby mode, the MPI card slot is powered by the Standby power supply and embedded *b*-LAN is not powered. When the TV is in Power On mode, the MPI card slot is powered by the main 12V power supply and embedded *b*-LAN is powered. Note that the TV must be turned ON in order to communicate with the embedded *b*-LAN module for configuration and control when Power Savings is set to 3.

- **1 = MPI card slot Standby Mode power provided from Standby power supply, and embedded *b*-LAN is always powered.**
- **3 = MPI card slot Standby Mode power provided from Standby power supply, and embedded *b*-LAN is only powered when the TV is turned ON.**
- **7 = MPI card slot Standby Mode power provided from Standby power supply, and embedded *b*-LAN is never powered.**

Reference: Detailed Instructions for Making a Master TV

IMPORTANT INSTALLER SETUP INFORMATION! PLEASE READ THE FOLLOWING...



To set up a Master TV, you will need to know how to enter the TV Installer Menu and make changes to the default values as required. If necessary, familiarize yourself with the Installer Menu and how to make and save changes in the menu, before attempting to clone the Master TV Setup.

You will also need an LG Installer Remote similar to the one shown in this manual. The Installer Remote must have a SOURCE button or its equivalent. The remote shown in this manual has an INPUT button, which serves the purpose of a SOURCE button.

Finally, the TV's clonable features need to be set up. This is a critical step. If the Master TV display panel's clonable

features, such as adding channel icons or channel labels, digital font options, etc., are not correctly added, the cloned TVs will all have problems.

As you perform the cloning procedure, you must complete specific steps at the indicated times in order to achieve the desired result. Be sure to perform each task as indicated. If a procedure or step is left out or not performed completely, cloning may not work. At each step, pay attention to ensure the TV screen shows the proper message when cloning. If the message indicated does not appear, there is a problem with that step, and cloning may not be successful. Cloning is only possible when the signal source is an analog channel, not a digital channel.

Making a Master TV

The following procedure describes how to prepare a Master TV for cloning. Refer to the next page for procedures for adding channel icons and/or labels.

Note 1: Disconnect all Aux inputs. Under certain conditions, Auto Tuning (Channel Search) is disabled if there is an Aux input active.

Note 2: Under certain conditions, changes to the input mode of the RGB inputs will not take effect until the power is cycled (TV is turned OFF and ON). To avoid confusion, disconnect all RGB inputs before entering the Installer Menu.

1. Enter the TV Installer Menu.
- a. Reset the internal controller to factory default: access Installer Menu item **117 FACT DEFAULT**, set it to **1**, and press **ENTER** on the Installer Remote. The value will change back to 0 after the TV's internal controller has been restored to factory default condition. This step will ensure that the TV Channel Memory will be the active Channel List.
- b. It is important to set the Tuning Band (Installer Menu item **003 BAND/AFC**) at this time. Refer to the "Installer Menu" section for details, and set as appropriate.
- c. Set any other Installer Menu items to the configuration required of your institution.
2. Press **ENTER** to exit the Installer Menu and save your changes.
3. Access the Master TV menus, and set the clonable options on the menus to the desired configuration

(Refer to the Clonable Menu Features chart in this manual.)

4. Run Auto Tuning to find analog and digital channels.
5. Enter the Channel Edit Menu, and edit the Channel Lineup to include the Free-To-Guest channels only.
6. Assign icons to the channels using the Channel Label Menu.
Note: You can add channel icons, typically network logos, such as ABC, NBC, PBS, etc., in this step; or, in step 8, you can add channel icons or labels for channels without icons.
7. Transfer the TV Setup: Enter the TV Installer Menu, and press **2-5-5 + MENU** to start the transfer of the TV Setup to the internal controller. Once the transfer is complete, the system will exit the Installer Menu.
8. Edit/add channel icons and channel labels as needed. Enter the Installer Menu, and press **2-5-4 + MENU**. See next page for detailed instructions.
9. Verify the Master TV Setup and feature configuration:
 - Did you add channel icons and/or labels?
 - Did you add source labels?
 - Did you adjust all TV menu options as required?
10. After verifying the Master Setup, enter the TV Installer Menu, and set Installer Menu item **028 CH. OVERRIDE** to **000**.
11. Press **ENTER** to exit the Installer Menu and save your changes.

Reference: Adding Channel Icons / Custom Channel Labels (2-5-4 + MENU Mode)

Editing/Adding Channel Icons and/or Labels

If there is no pre-assigned icon, you can make a custom channel label of up to seven (7) characters to help identify a channel or network. If desired, channel labels can also be added in addition to a pre-assigned icon. You may also add labels for the Aux input sources to clearly identify the devices that are connected to the Aux inputs.

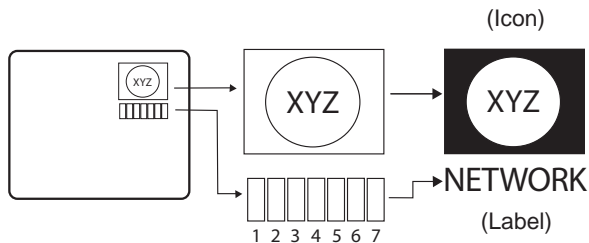

Editing and adding the labels can only be done if there are channels entered into the TV's Channel Map either by using the method described on the previous page, by cloning, or by using the master remote control from the PPV provider.

Note: A blank letter space is available between "Z" and "I".

To perform channel editing/labeling, proceed as follows:

1. Enter the TV Installer Menu.
2. Press **2-5-4 + MENU** to enter the Channel Label Editing Mode.
3. Add your channel icons and channel labels as described in the procedures below. (You can do this more than once.)
4. To exit the menu when you are done, press **MENU**.

Changing a Channel's ICON on the Master TV

1. With Channel Up/Down, select the channel for which you wish to change the icon.
2. With the ADJ Left/Right arrow, select the thin letter "I" on the Channel ID display.
3. Use the Up/Down arrow keys to select the icon with which you want to identify the channel. (If you know the icon number, enter the number, and press **ENTER/SELECT**.)
4. Proceed with changing/adding channel labels, or go to the next channel.

Changing/Adding Channel Labels on the Master TV

1. With Channel Up/Down, select the desired channel.
2. Press the ADJ Left/Right arrow repeatedly until the numbers 1 to 7 appear on the display. The number shows the position of the character that can be changed. Number 1 is the first character, number 2 the second character, and so on.
3. Use the Up/Down arrow keys to select the desired character.
4. Proceed to the next number position or use Channel Up/Down to go to the next channel.

Changing Source Labels on the Master TV

1. Press **INPUT** to select the desired Aux input source: A/V 1, A/V 2, HDMI Component, RGB, etc.
2. Press the ADJ Left/Right arrow repeatedly until the numbers 0 to 9 appear on the display. The number shows the position of the character that can be changed.
3. Use the Up/Down arrow keys to select the desired character.
4. Press **INPUT** for the next Aux source, or proceed with changing an icon or changing/adding labels. Use Channel Up/Down to return to channels.

Installer Remote Control Key Functions for Master TV Channel Editing/Labeling Menu

- **Channel Up/Down:** Tunes in the next channel in scan.
- **Left/Right Arrows:** Select the item to change. If "I" is shown, the icon can be changed. If a number is shown, it indicates the position of the character that can be changed.
- **Up/Down Arrows:** Select the icon or the character to be displayed. Tip: Arrows can be held down for fast scrolling.
- **0 – 9:** Use to enter the index number of the icon, if known.
- **ENTER/SELECT:** Changes the icon after the number has been entered.
- **INPUT:** Changes the Aux input label.
- **MENU:** Exits the editing process.

Reference: Clonable Menu Features / Checking Software Version

Clonable Menu Features		
Menu/Submenu Features Installer Menu Installer Item settings Channel Auto Tuning (Channel Lineup) Channel Edit Channel label Picture Aspect Ratio Picture Mode Advanced Control Audio Auto Volume Clear Voice Sound Mode Balance	Audio (Cont.) Treble Bass SRS TruSoundXT TV Speaker Option Language Caption Caption Mode DTV Captions Style - Style DTV Captions Style - Size DTV Captions Style - Font DTV Captions Style - Text Color DTV Captions Style - Text Opacity DTV Captions Style - BG Color DTV Captions Style - BG Opacity DTV Captions Style - Edge Type DTV Captions Style - Edge Color	Lock Movie Rating TV Rating – Children Age TV Rating – Children Fantasy Violence TV Rating – General Age Input Block Time Auto Clock Manual Clock Off Time On Time Auto Off

Notes

- Picture Menu and other menu settings shown above are not clonable on all TVs. The end user has access to Picture, Sound, and Ratio on the user remote control.
- Menu options vary between analog and digital channels and Aux sources.

Checking the Software Version

You can check the software version of the TV by accessing the Installer Menu.

To do this, press **MENU** repeatedly until the on-screen menu locks up. Then, press **9-8-7-6** + **ENTER**. When you are finished, press **ENTER** again to exit the Installer Menu.

Typical Installer Menu

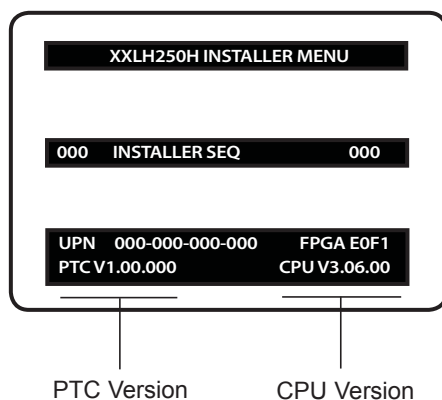

USB Menu Features: Picture Slideshow with or without Music Accompaniment

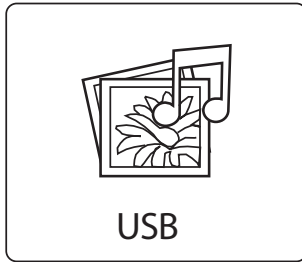

USB Device Setup

On the USB device, load Photo and Music files, for example, MP3s. Insert the USB device into the USB port on the TV side jack panel. Press **MENU**, and select the USB option. Then, press **ENTER**.

Note: Windows .wma files are not compatible.

View Pictures

Select the USB icon, and press **ENTER**. Select the **Photo List** option, and press **ENTER**. Select the folder that contains the photos. Press **ENTER**. When the photo list appears, choose **Photo**, and press **ENTER**.

View Picture with Music

Select the USB icon, and press **ENTER**. Select the **Music Folder** option. Select **Music List**, and select **Play with Photo**. Select the music MP3 file, and press **ENTER**.

Listen to Music MP3 Files

Select the USB icon, and press **ENTER**. Select **Music List**, and press **ENTER**. Select the folder with music MP3 files. Press **ENTER**. Adjust the volume to a comfortable listening level.

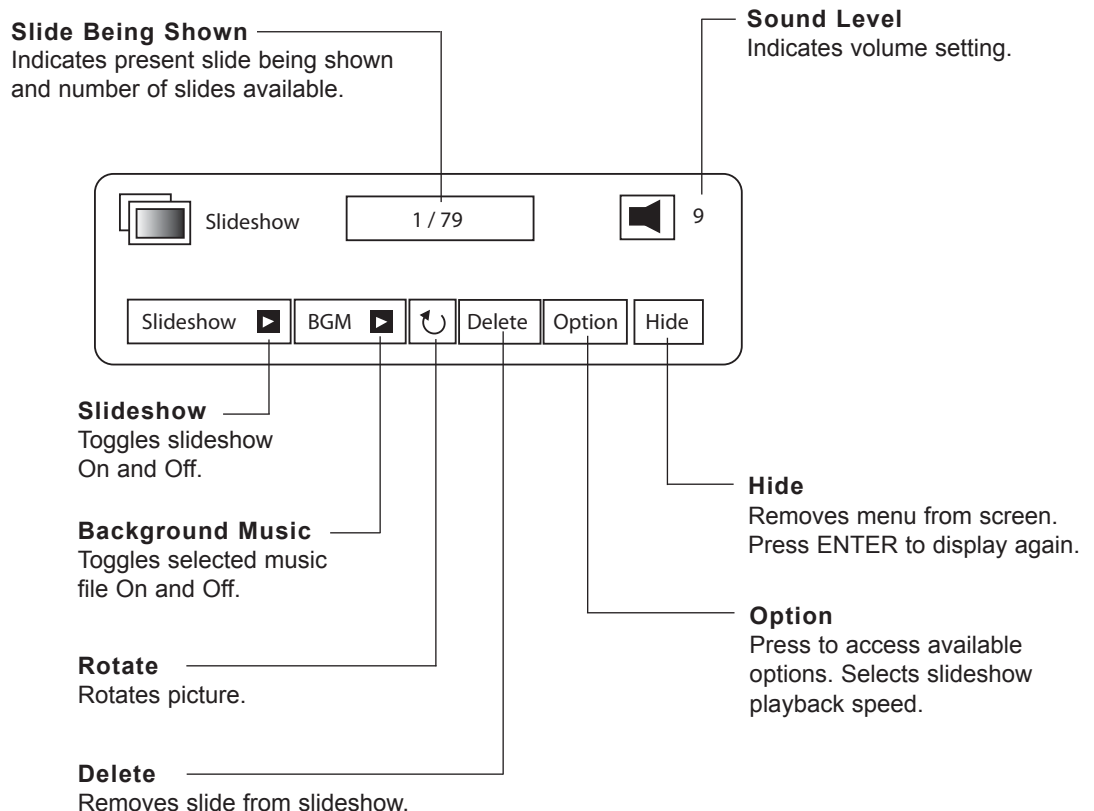

Reference: USB Cloning / Master TV Profile Setup-Learning

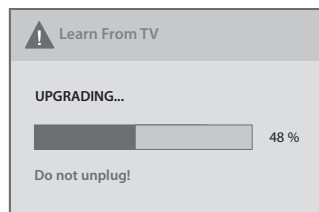
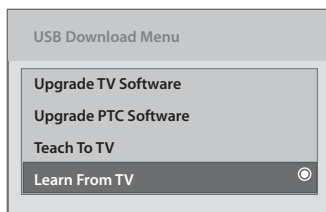

On Master TV, Create Profile and Learn

1. Set up all Master TV features on the menus, and do a Channel Search. Add channel and Aux labels, etc. Then, press **2-5-5 + MENU** to save the current TV into flash memory.
2. Plug the USB memory card into the USB In port on the Master TV.
3. Press **MENU** to open the Main Menu.
4. Press the Left arrow key once to highlight the **OPTION** icon on left side of menu.
5. Press the number key “**7**” a total of seven times.
6. Access the **LEARN FROM TV** option.

Note: At first, the Expert Download Menu page will not show the LEARN FROM TV option. In order to make LEARN FROM TV available, key in the password that is used to enter the Installer Menu. Example: 9-8-7-6.

7. Use the Up/Down arrow keys (if there are other menus) to highlight **LEARN FROM TV**, and then press **ENTER**.
8. To identify the profile from others, you can change the last five (5) digits. Key in a custom file name, and then press **ENTER**.

The Learning Status will be shown on the progress bar. As soon as current profile learning is complete, a message will appear on screen indicating that the learning process is done.

9. Remove the USB memory card.

Optional: Edit / Change File Name

If necessary, you can edit or change the file name.

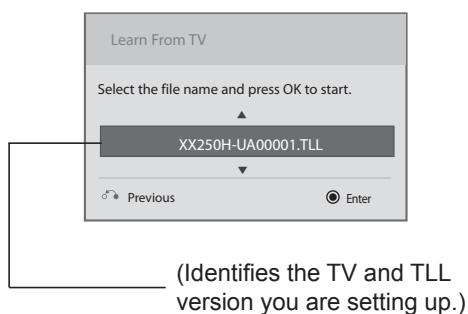

Notes

- Do not remove the TV power cord or USB memory card while Learning, as doing so may harm your USB memory card.
- Do not remove the TV power cord or USB memory card while Teaching, as doing so may cause the TV to malfunction.
- You are allowed to edit the file name; however, a file with edited contents will not be recognized.
- Since clock data is copied into the USB memory card as numeric data, the time difference between Teaching and Learning is not automatically adjusted. Either set the clock manually, or use Auto Clock set on the TV Main Menu.

Reference: USB Cloning / Master TV Profile Setup-Teaching



(Identifies the TV and TLL version you are setting up.)

On Target TV, Teach Master TV Profile

1. Plug the USB memory card with the Master TV profile setup into USB In port on the Target TV.
2. Press **MENU** to open the Main Menu.
3. Press the Left arrow key once to highlight the **OPTION** icon on left side of menu.
4. Press number key "7" a total of seven times.
5. Use the Up/Down arrow keys to select **TEACH TO TV**, and then press **ENTER**.
6. Use the Up/Down arrow keys to navigate through profiles. Select the profile that you want to install by highlighting it and pressing **ENTER**.
Teaching progress will be shown on the progress bar. As soon as teaching is done, a message will appear indicating that the Teaching process has been completed.
7. When Teaching is done, remove the USB memory card, and unplug TV power cord.
8. Reconnect the TV power cord. Turn the TV ON, and check that the Master Setup is resident on the TV.

Reference: TV Camport Auto Sense Operation

The Camport Auto Sense function is enabled when:

1. Installer Menu item 34 CAMPORT EN is set to 1 AND
2. Installer Menu item 40 AUTO CAMPORT is enabled (1).

Selectable: Can be accessed with INPUT key, direct access, etc.

Auto Sense: Switches to this input when connector is inserted. The Camport (Side Video) has the highest priority and will override any commands including tuning to the Start Channel.

CAMPOR (Front Video) Functionality Control

Item 34 CAMPORT EN	Item 40 AUTO CAMPORT	Front Video Operation
0	0	Disabled
0	1	Disabled
1	0	Selectable
1	1	Auto Sense

Camport Operation (Stand-Alone)

When Camport Auto Sense is enabled as above, the TV's source will switch to the Side Video Aux source whenever a plug is inserted into any of the Side Video panel inputs (either Composite Video or S-Video).

When the plug is removed, the TV will switch back to the previous channel or input source that the TV was using before the plug was inserted. However, if any direct access to an RF channel or Aux channel is requested while the Camport is active, then, when the Camport plug is removed, the TV will switch to the last requested channel. Source changes using any Source keys (INPUT) are ignored. Channel Up/Down and Flashback commands are not direct access tuning commands, and they are also ignored.

Previous State Before Inserting CAMPORT	Operation While CAMPORT is Active	State Upon Removal of CAMPORT
Aux or RF Channel	None	Previous Aux or RF Channel
Aux or RF Channel	Direct Access	Last Requested RF or Aux Channel
Aux or RF Channel	Ch Up/Down, Flashback, and TV/AV Keys	Previous Aux or RF Channel

Camport Operation (PPV)

The operation will be similar to that of the Stand-Alone Mode. However, the PPV providers may send different commands to the TV for the same user commands. For instance, some providers will always send a direct tune command when they receive a Channel Up/Down or a Flashback command while other PPV providers will just send a key command.

Previous State Before Inserting CAMPORT	Operation While CAMPORT is Active	State Upon Removal of CAMPORT
Aux or RF Channel	None	Previous Aux or RF Channel
Aux or RF Channel	Direct Access	Last Requested RF or Aux Channel
Aux or RF Channel	Ch Up/Down, Flashback, and TV/AV Keys	Last Requested Channel if PPV translates it to direct access tuning com- mand. Otherwise, goes to Previous Aux or RF Channel

Reference: TV Aux Input Configuration

DIRECT ACCESS Tuning		TV		ENABLE				MPI DATA			START AUX SOURCE ASSIGNMENT
				Installer Menu		MPI DATA STATUS TYPE 0x41 SOURCES ENABLED (R/W)		DATA STATUS TYPE 0xD2 CURRENT AV SOURCE (R)		DATA STATUS TYPE 0x0D AUX SOURCE (R)	
OLD_OCV = 0	OLD_OCV = 1	Source Input	Source Mode	Number	Labeling	Value	Labeling	Value	Labeling		
130	90	Video2 (Side)	CV/SVIDEO	34	CAMPORT_EN	0x01	Video Front (Camport)	0	Video Front (Camport)	0 (VIDEO)	2
131	91	Video1 (Rear)	CV/SVIDEO	39	REAR_AUX_EN	0x02	Rear Video (Aux)	1	Rear Video (Aux)	0 (VIDEO)	1
132	92	HDMI2	DTV/PC	91	YPrPb2 EN = 1	0x04	S-Video Rear	2	S-Video Rear	0 (VIDEO)	5
133	93	HDMI1/DVI	DTV/PC	35	COMPPORT_EN = 1	0x08	Front Computer	3	Front Computer	0 (VIDEO)	3
134	94	RGB	PC	87	REAR RGB EN = 2	0x10	SVGA Rear Computer	4	SVGA Rear Computer	2 (COMPUTER)	4
136	96	Component		38	YPrPb EN	0x40	Y/UV Component	6	Rear Y/PrPb Component Video	0 (VIDEO)	6

Reference: General Troubleshooting

Some Quick and Easy Tips for Resolving Problems

Symptom	Possible Cause(s)	Possible Solution(s)
Software Problems		
Cannot direct enter channel number or "No Signal" appears.	Channel not included in Channel Scan in TV controller.	After 2-5-5 + MENU, only channels included in TV controller will appear. If channel is available, it can be added to Channel Scan. If it is not available, the "No Signal" message appears on the TV screen.
Power		
No Power.	See troubleshooting flow chart.	
Display Panel Picture		
No Picture.	Display panel is turned off.	<ul style="list-style-type: none">• Turn TV ON.• Power failure?
	Antenna/cable not connected.	Connect antenna/cable signal to TV (see Owner's Manual).
	Connections incorrect.	Check connections on TV (see Owner's Manual).
	MPI not connected.	If applicable, connect MPI cable to MPI device.
	Encrypted program.	Try another channel.
	Wrong tuning band.	Adjust Installer Menu settings.
Erratic Operation		
Installer Menu setup.	Wrong Installer Menu settings.	Adjust Installer Menu settings as required.
Remote Control		
Remote doesn't work.	Remote not in TV Mode.	Use Mode key to select TV; puts remote into TV Mode.
	Not aimed at IR remote sensor.	Point remote at TV's IR receiver on TV.
	Remote too far from IR sensor.	Move remote closer to TV's IR receiver or darken room.
	MPI not connected.	If applicable, connect MPI cable to MPI device.
	IR path to TV's receiver obstructed.	Remove obstructions.
	Weak batteries.	Replace batteries.
	Wrong battery polarity.	Check that "+" and "-" match in battery compartment.
	Too much light in room.	Dim room light.
	Wrong Installer Remote.	Requires compatible Installer Remote. Contact your LG dealer.
Picture Reception		
Normal picture, poor or no sound.	Audio muted.	Press MUTE or use Volume Up key to increase sound level.
	Broadcast problem.	Try a different channel.

Note: For other problems not caused by the TV, refer to the other devices' operating guide(s).

Reference: LT2002 Cloning Procedure Troubleshooting



Warning: Do not use the LT2002 while any PPV card is installed in TV, or the Clone Programmer and the PPV card will be damaged.

Reset Clone After Static Shock

After replacing exhausted batteries, or if the Clone Programmer behaves strangely after a static shock, use a paper clip or similar instrument inserted through the small hole marked RESET to activate the internal reset switch and restore normal operation. After a reset, check the real-time clock setting. It may be necessary to reset the Clone Programmer clock from a TV containing the correct time.

Note

The LT2002 Programmer is designed to be used with TVs containing the 221-01006 and later processors. Use with earlier TV sets may give unpredictable results. Processors used before the 221-01006-04 have a limited screen display capability. They cannot display entire screens as shown in the quick setup instructions accompanying the LT2002 Clone Programmer. Use the printed menu illustrations on the quick setup sheet supplied with the Clone Programmer as an aid to making your programming choices. (Although the menus are not all displayed, the clone functions all operate normally.)

Clone Programmer Troubleshooting

Symptom	Possible Cause(s)	Possible Solution(s)
Clone Programmer		
Clone copies setup in less than 30 seconds.	Not enough time to copy entire TV setup.	Press RESET on Clone Programmer, redo Teach/Learn. (Teach/Learn should take a minimum of one (1) minute.)
Remote does not operate clone.	Wrong Installer Remote.	Only use an LG Installer Remote to operate Clone Programmer with TV.
LED does not blink.	MPI cord not connected. TV not turned ON. Weak batteries.	Connect MPI cord properly, and ensure good connection. TV must be powered ON for Clone Programmer to work. Install four (4) fresh AA high-quality alkaline batteries.
Clone menu hard to read.	Weak signal.	Connect TV to a reliable analog channel signal source.
No time set.	Time not available.	Set time on a TV, and copy time to Clone Programmer.
Clone not working.	Clone Programmer problem.	Try a different LT2002 Clone Programmer. Reset the Clone Programmer.
Clone scans channels more than once.	Clone should only scan channels once.	Try cloning again.

Master and Other TVs

Cloning did not work.	Procedure interrupted. Different TV models. Step(s) omitted or not performed.	Wait until procedure complete message is displayed. Cloning is only possible with identical model TVs. Refer to pages 20 to 23, and make sure all tasks were performed.
Clone time disappeared.	Batteries were removed.	Batteries must remain installed to retain time settings.
New setup not present.	TV not reset.	Disconnect newly-cloned unit from power for five (5) seconds.

- After cloning operations are complete, unplug the LT2002 from the TV.
- If the TV does not display a picture on the TV (blank screen) after a few seconds, just change channels.

Reference: Troubleshooting Flow Chart

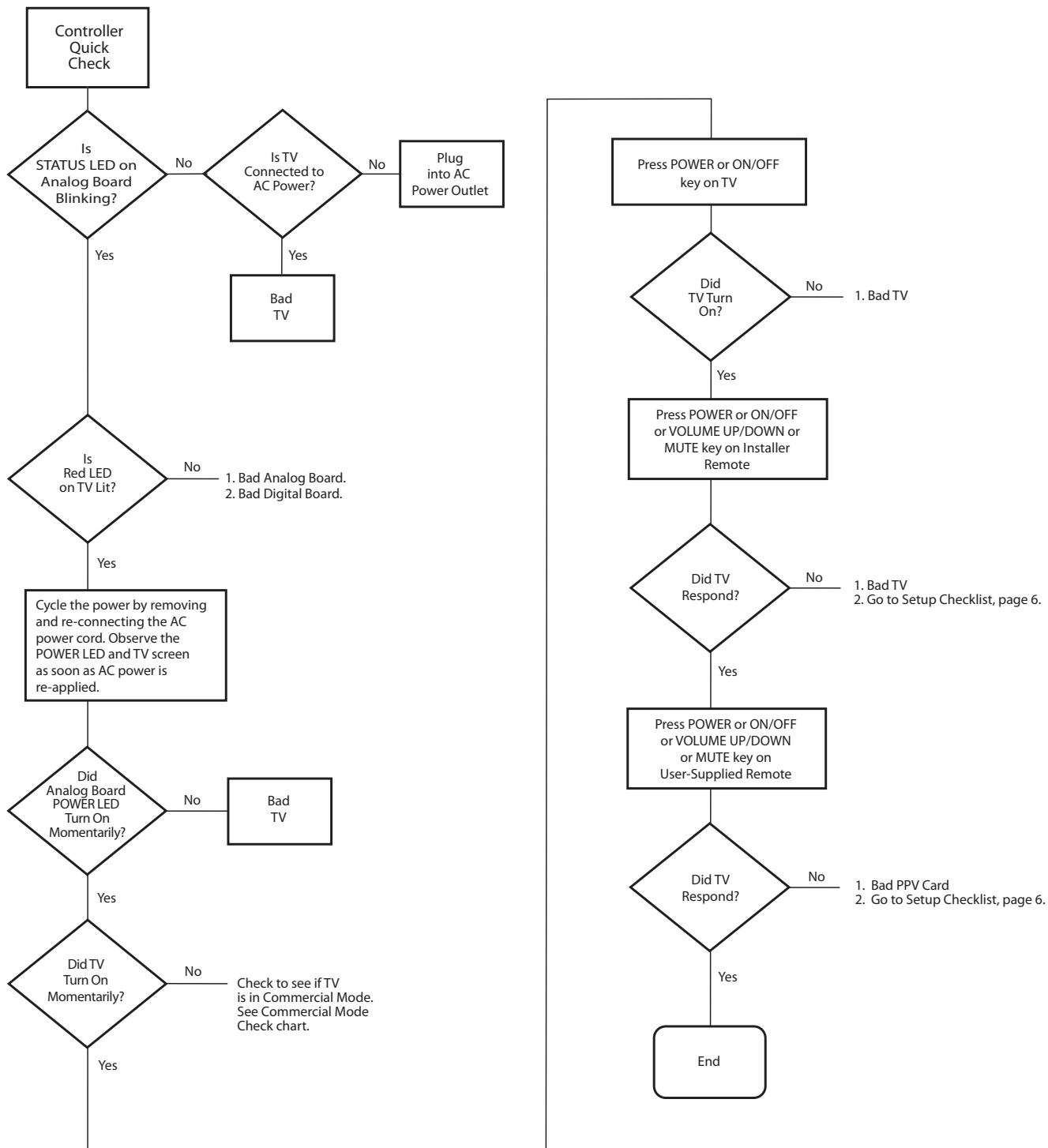

Reference: Commercial Mode Check

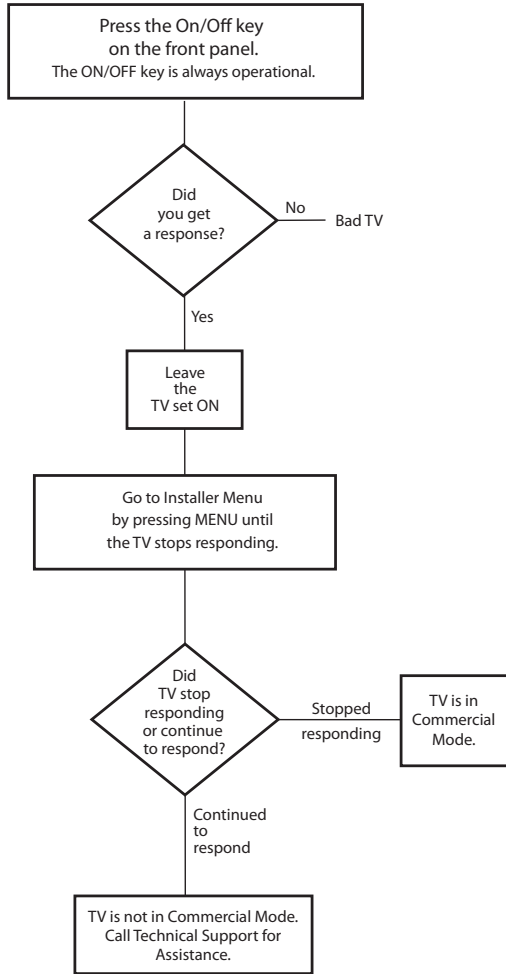

Reference: *b*-LAN Setup & Overview

Power to the *b*-LAN module is controlled by Installer Menu item 118 POWER SAVINGS. The default value is 003. The *b*-LAN module is only powered when the TV is turned ON. See chart below.

Power Savings	TV Standby State		TV Power On State	
	<i>b</i> -LAN Power	MPI Slot Power	<i>b</i> -LAN Power	MPI Slot Power
001	On	Standby	On	Main
003	Off	Standby	On	Main
007	Off	Standby	Off	Main

The *b*-LAN module is internal to the TV. It allows the Hotel/Institution head end equipment to communicate with the TV for configuration and control. This communication is via the institution's RF distribution system. The control device at the head end (Example: FMA-LG101) can control multiple TVs. When the TV is first installed, it must be turned ON in order for the head end to be able to communicate with the *b*-LAN. At this point, if it is desired for the *b*-LAN to always be powered, including during Standby Mode, disable Installer Menu item 118 POWER SAVINGS by setting it to 001. The new settings will not be active until the *b*-LAN actually downloads the configuration data to the PTC and the PTC is reset.

If the application only requires use of the MPI card slot, and the embedded *b*-LAN will not be used, the installer can go into the Installer Menu and enable maximum power savings in both Standby and TV Power On Mode by setting Installer Menu item 118 POWER SAVINGS to 007.

Reference: RJP Model List and Input Auto-sensing Hierarchy

RJP Model List

Legacy Models	Scaler Models
RJP-101M	N/A
RJP-101ML	N/A
RJP-110F	RJP-210F
RJP-110FW	RJP-210FW
RJP-110W	RJP-210W
RJP-110WBR	RJP-210WBR
RJP-110S	RJP-210S
RJP-120G	RJP-220G
RJP-120T	RJP-220T
RJP-201B	RJP-301B
RJP-202B	RJP-302B

RJP Input Auto-sensing Hierarchy

Priority	Video	Audio
1st	Digital Video In	Audio In (3.5mm)
2nd	PC Video In	Audio In (L/R)
3rd	Video In	Digital Video In

Reference: Glossary of Terms

A list of definitions for some of the words found in this guide.

75 OHM RF CABLE

The wire that comes from an off-air antenna or cable service provider. The end looks like a hex-shaped nut with a wire sticking through the middle. It screws onto the Antenna/Cable threaded jack on the back of the TV.

300 TO 75 OHM ADAPTER

A small device that connects a two-wire 300 ohm antenna to a 75 ohm RF jack. They are usually about an inch long with two screws on one end and a round opening with a wire sticking out on the other end.

A/V CABLES

Audio/Video cables. Three cables bunched together—right audio (red), left audio (white), and video (yellow). A/V cables are used for stereo playback of videocassettes and for higher quality picture and sound from other A/V devices.

A/V DEVICE

Any device that produces video or sound (VCR, DVD, cable box, or television).

AMPLIFIER

An electronic device that amplifies sound from a television, CD player, VCR, DVD, or other Audio/Video device.

ANTENNA

The physical receiver of television signals sent over the air. A large metal piece of equipment does not always have to be visible to be using an antenna.

b-LAN

TV is controlled by external network.

CABLE

Cable service box. Refers to the descrambler box cable subscribers use to receive cable programming signals.

CATV

Programming provided by a cable service.

COMPONENT VIDEO

Uses three wires for transporting three-color video signals. The end result is usually better video quality.

COMPOSITE VIDEO

Typical video jack, uses one wire for transporting three-color video signals.

DELETE

Lets you remove channels from the list that the end user can scroll through using Channel Up/Down.

DIGITAL TELEVISION

High-resolution, cinema-quality television signals transmitted digitally.

DVI

Digital Video Interface. Accommodates analog and digital interfaces with a single connector.

HDMI

High-definition multi-media interface.

HDSTB

High-definition set-top box. Refers to a tuner device that receives high-definition television signals which have higher resolution than ordinary analog TV signals.

HDTV

High-definition television. Refers to television signals that have higher resolution than ordinary analog TV signals.

INPUT

Refers to the input jack that receives a signal from a TV, VCR, DVD Player or other Audio/Video device.

JACK

An input or output connector on the back of a TV, VCR, DVD Player, or other Audio/Video device.

MONO SOUND

Mono (monaural) sound is one channel of sound. On more than one speaker, all the speakers play the same audio.

OUTPUT

Refers to the output jack that sends a signal out of a VCR, DVD, or other A/V device.

PHYSICAL CHANNEL NUMBER

The actual channel number. Analog channels use the physical channel number, while digital channels can use a virtual channel number.

RGB (Red, Green, Blue)

Connection input or output port available for producing a video image using three separate colors: Red, Green, and Blue.

RS-232

Serial communication port through which firmware is downloaded.

2ND AUDIO PROGRAMMING/SAP

Second Audio Programming (SAP) is another, separate audio channel available with some programming. Choosing SAP often refers to listening to audio in another language, such as Spanish or French.

SIGNAL

Picture and sound traveling through a cable, or over the air, to the TV.

STEREO SOUND

Stereo (Stereophonic) sound refers to audio that's divided into right and left sides.

TUNER

Device that picks up the broadcast signal and turns it into picture and sound.

VIRTUAL CHANNEL NUMBER

A re-mapped channel number. Analog channels use the physical channel number; however, digital channels use a virtual (or false) channel number.

XDS

Extended Data Service (XDS) is additional program information included on the signal provided at the discretion of the broadcaster.

Note: Refer to www.atsc.org for further information.

Document Revision History

Date	Description
August 2009	Revision A: New document
February 2010	Revision B: Enhanced <i>b</i> -LAN and Installer Menu description
February 2010	Revision C: Includes LH260H and LH265H TVs

Product documentation is available online at: www.LGcommercial.com/products. From the Products page, select **LCD TV**, then select the appropriate TV model. Click the **Downloads & Images** tab, and select the required document from the Downloads list.

Notes



For Customer Support/Service, please call:

1-888-865-3026

www.LGcommercial.com

Marketed and Distributed in the United States by LG Electronics U.S.A., Inc.
1000 Sylvan Avenue, Englewood Cliffs, NJ 07632

Free Manuals Download Website

<http://myh66.com>

<http://usermanuals.us>

<http://www.somanuals.com>

<http://www.4manuals.cc>

<http://www.manual-lib.com>

<http://www.404manual.com>

<http://www.luxmanual.com>

<http://aubethermostatmanual.com>

Golf course search by state

<http://golfingnear.com>

Email search by domain

<http://emailbydomain.com>

Auto manuals search

<http://auto.somanuals.com>

TV manuals search

<http://tv.somanuals.com>